

# ETSI TS 144 060 V12.3.0 (2015-01)



TECHNICAL SPECIFICATION

**Digital cellular telecommunications system (Phase 2+);  
General Packet Radio Service (GPRS);  
Mobile Station (MS) - Base Station System (BSS) interface;  
Radio Link Control / Medium Access Control (RLC/MAC)  
protocol  
(3GPP TS 44.060 version 12.3.0 Release 12)**



---

Reference

RTS/TSGG-0244060vc30

---

Keywords

GSM

**ETSI**

650 Route des Lucioles  
F-06921 Sophia Antipolis Cedex - FRANCE

Tel.: +33 4 92 94 42 00 Fax: +33 4 93 65 47 16

Siret N° 348 623 562 00017 - NAF 742 C  
Association à but non lucratif enregistrée à la  
Sous-Préfecture de Grasse (06) N° 7803/88

---

**Important notice**

The present document can be downloaded from:

<http://www.etsi.org>

The present document may be made available in electronic versions and/or in print. The content of any electronic and/or print versions of the present document shall not be modified without the prior written authorization of ETSI. In case of any existing or perceived difference in contents between such versions and/or in print, the only prevailing document is the print of the Portable Document Format (PDF) version kept on a specific network drive within ETSI Secretariat.

Users of the present document should be aware that the document may be subject to revision or change of status. Information on the current status of this and other ETSI documents is available at

<http://portal.etsi.org/tb/status/status.asp>

If you find errors in the present document, please send your comment to one of the following services:

[http://portal.etsi.org/chaicor/ETSI\\_support.asp](http://portal.etsi.org/chaicor/ETSI_support.asp)

---

**Copyright Notification**

No part may be reproduced or utilized in any form or by any means, electronic or mechanical, including photocopying and microfilm except as authorized by written permission of ETSI.

The content of the PDF version shall not be modified without the written authorization of ETSI.

The copyright and the foregoing restriction extend to reproduction in all media.

© European Telecommunications Standards Institute 2015.

All rights reserved.

**DECT™**, **PLUGTESTS™**, **UMTS™** and the ETSI logo are Trade Marks of ETSI registered for the benefit of its Members. **3GPP™** and **LTE™** are Trade Marks of ETSI registered for the benefit of its Members and of the 3GPP Organizational Partners.

**GSM®** and the GSM logo are Trade Marks registered and owned by the GSM Association.

---

## Intellectual Property Rights

IPRs essential or potentially essential to the present document may have been declared to ETSI. The information pertaining to these essential IPRs, if any, is publicly available for **ETSI members and non-members**, and can be found in ETSI SR 000 314: *"Intellectual Property Rights (IPRs); Essential, or potentially Essential, IPRs notified to ETSI in respect of ETSI standards"*, which is available from the ETSI Secretariat. Latest updates are available on the ETSI Web server (<http://ipr.etsi.org>).

Pursuant to the ETSI IPR Policy, no investigation, including IPR searches, has been carried out by ETSI. No guarantee can be given as to the existence of other IPRs not referenced in ETSI SR 000 314 (or the updates on the ETSI Web server) which are, or may be, or may become, essential to the present document.

---

## Foreword

This Technical Specification (TS) has been produced by ETSI 3rd Generation Partnership Project (3GPP).

The present document may refer to technical specifications or reports using their 3GPP identities, UMTS identities or GSM identities. These should be interpreted as being references to the corresponding ETSI deliverables.

The cross reference between GSM, UMTS, 3GPP and ETSI identities can be found under <http://webapp.etsi.org/key/queryform.asp>.

---

## Modal verbs terminology

In the present document "**shall**", "**shall not**", "**should**", "**should not**", "**may**", "**may not**", "**need**", "**need not**", "**will**", "**will not**", "**can**" and "**cannot**" are to be interpreted as described in clause 3.2 of the [ETSI Drafting Rules](#) (Verbal forms for the expression of provisions).

"**must**" and "**must not**" are **NOT** allowed in ETSI deliverables except when used in direct citation.

# Contents

Intellectual Property Rights .....	2
Foreword.....	2
Modal verbs terminology.....	2
Foreword.....	18
1 Scope .....	19
1.1 General .....	19
1.2 Related documents .....	19
1.3 Use of logical control channels .....	19
1.4 Use of logical traffic channels.....	20
1.5 Conventions.....	20
1.6 Restrictions.....	21
2 References .....	21
3 Definitions, abbreviations and symbols .....	23
3.1 Definitions .....	23
3.2 Abbreviations .....	28
3.3 Symbols.....	30
4 Layered overview of radio interface.....	30
4.1 Layer services.....	31
4.2 Layer functions.....	31
4.3 Service primitives.....	32
4.4 Services required from lower layers.....	32
5 Introduction to the Medium Access Control (MAC) procedures .....	32
5.1 General .....	32
5.2 Multiplexing principles .....	32
5.2.1 Temporary Block Flow .....	32
5.2.2 Temporary Flow Identity .....	34
5.2.3 Uplink State Flag .....	34
5.2.4 Medium Access modes .....	34
5.2.4a Multiplexing of GPRS, EGPRS and EGPRS2 capable mobile stations.....	35
5.3 Packet idle mode .....	36
5.3.1 Broadcast/multicast receive mode .....	36
5.4 Packet transfer mode .....	37
5.4a Dual transfer mode .....	37
5.5 General procedures in packet idle and packet transfer modes .....	38
5.5.1 Mobile station side.....	38
5.5.0.1 Indication of a selected PLMN.....	38
5.5.1.1 Cell reselection.....	38
5.5.1.1a Network Assisted Cell Change .....	39
5.5.1.1a.1 Neighbour Cell System Information Distribution .....	40
5.5.1.1a.2 CCN Mode .....	40
5.5.1.1b Release of RR connection .....	40
5.5.1.1b.1 General .....	40
5.5.1.1b.2 Continuation of PBCCCH information .....	40
5.5.1.1b.3 Continuation of BCCH information .....	41
5.5.1.1b.4 Receipt of PSI14 message in dual transfer mode .....	41
5.5.1.1b.5 Acquisition of system information for enhanced DTM CS release procedure in dual transfer mode .....	41
5.5.1.1c Inter-RAT cell re-selection based on priority information.....	42
5.5.1.1c.1 General .....	42
5.5.1.1c.2 Common priorities information.....	43
5.5.1.1c.3 Provision of individual priorities information .....	43
5.5.1.1d (void) .....	43

5.5.1.2	System information on PBCCH .....	43
5.5.1.2.1	Supervision of PBCCH_CHANGE_MARK and update of PBCCH information .....	44
5.5.1.2.2	Replacement of PBCCH .....	44
5.5.1.2.3	PSII reception failure .....	45
5.5.1.3	System information on BCCH .....	45
5.5.1.3.1	Supervision of BCCH_CHANGE_MARK and update of BCCH information .....	45
5.5.1.3.2	Establishment of PBCCH .....	46
5.5.1.3.3	SII3 reception failure .....	46
5.5.1.4	Acquisition of system information on the broadcast channel .....	46
5.5.1.4.1	Consistent sets of system information messages .....	47
5.5.1.4.2	Suspension of operation to receive system information .....	47
5.5.1.4.3	Request for acquisition of system information .....	47
5.5.1.5	Discontinuous reception (DRX) .....	48
5.5.1.6	Page mode procedures on PCCCH .....	50
5.5.1.7	Frequency Parameters .....	50
5.5.1.8	TLLI management .....	53
5.5.1.9	Packet Flow Context (PFC) .....	53
5.5.1.10	Acquisition of E-UTRAN Information on the PACCH .....	54
5.5.2	Network side .....	55
5.5.2.1	System Information broadcasting .....	55
5.5.2.1.1	System information on PBCCH .....	55
5.5.2.1.2	System information on BCCH .....	55
5.5.2.1.3	System information on PACCH (and other logical channels) .....	56
5.5.2.1.3a	Rules for (P)SI distribution within Packet Serving Cell Data messages .....	57
5.5.2.1.3b	Rules for (P)SI distribution on PACCH of an MBMS radio bearer .....	57
5.5.2.1.4	Consistent sets of system information messages .....	57
5.5.2.2	Paging .....	58
5.5.2.3	Network Assisted Cell Change .....	59
5.5.2.4	Packet Switched Handover .....	59
5.6	Measurement reports .....	59
5.6.0	General .....	59
5.6.1	Network Control (NC) measurement reporting .....	60
5.6.2	(void) .....	61
5.6.3	Additional measurement and reporting parameters .....	61
5.6.3.1	Deriving the 3G Neighbour Cell list from the 3G Neighbour Cell description .....	61
5.6.3.1a	Deriving the E-UTRAN Neighbour Cell list from the Repeated E-UTRAN Neighbour Cell information .....	62
5.6.3.2	Deriving BA(GPRS) and the GSM Neighbour Cell list .....	63
5.6.3.3	Deriving the Neighbour Cell list from the GSM Neighbour Cell list and the 3G Neighbour Cell list .....	64
5.6.3.4	GPRS Real Time Differences .....	64
5.6.3.5	GPRS Report Priority Descriptions .....	65
5.6.3.6	GPRS Measurement Parameters and GPRS 3G Measurement Parameters .....	65
5.6.3.6a	GPRS E-UTRAN Measurement Parameters .....	65
5.6.3.7	The GPRS 3G Cell Reselection list .....	66
5.6.3.7a	(void) .....	66
5.6.3.7b	The 3G Frequency list .....	66
5.6.3.8	Closed Subscriber Group Information .....	66
5.6.3.9	Reporting of CSG Cells and Hybrid Cells .....	67
5.6.4	Measurement reporting in broadcast/multicast receive mode .....	68
5.7	Dual transfer mode enhancements .....	69
5.8	DTM Handover .....	69
5.9	Downlink Dual Carrier .....	69
5.10	ETWS Primary Notification .....	69
5.11	Enhanced Multiplexing for Single TBF .....	69
5.12	Enhanced Multiplexing for a Single RLC Entity .....	70
5.13	Downlink Multi Carrier .....	71
6	Paging procedures .....	72
6.1	Paging procedure for RR connection establishment .....	72
6.1.1	Paging initiation using paging subchannel on CCCH .....	72
6.1.2	Paging initiation using paging subchannel on PCCCH .....	72

6.1.3	Paging initiation using PACCH .....	72
6.1.4	Paging response .....	73
6.2	Paging procedure for downlink packet transfer .....	73
6.2.1	Paging procedure using paging subchannel on CCCH .....	74
6.2.2	Paging using paging subchannel on PCCCH .....	74
6.2.3	Paging response .....	74
6.3	Paging Procedures for MBMS Notification .....	74
6.3.1	Notification to mobile station in packet idle mode .....	74
6.3.1.1	General .....	74
6.3.1.2	Paging procedure for MBMS notification using paging subchannel on CCCH .....	74
6.3.1.3	Paging procedure for MBMS notification using paging subchannel on PCCCH .....	74
6.3.1.3.1	General .....	74
6.3.1.3.2	MBMS pre-notification .....	75
6.3.1.3.3	MBMS notification .....	75
6.3.1.3a	Paging procedure for MBMS notification using PACCH .....	76
6.3.1.4	Response to MBMS Notification .....	76
6.3.2	Notification to mobile station in packet transfer mode or in dual transfer mode .....	77
6.3.2.1	General .....	77
6.3.2.2	MBMS Notification using the PACCH .....	77
6.3.2.3	Response to MBMS Notification received on PACCH .....	77
6.4	Paging Procedure for ETWS Primary Notification delivery .....	78
6.4.1	General .....	78
6.4.2	ETWS Primary Notification delivery using paging subchannel on CCCH .....	78
6.4.3	ETWS Primary Notification delivery using paging subchannel on PCCCH .....	78
6.4.4	Reception of ETWS Primary Notification message .....	78
7	Medium Access Control (MAC) procedures on PCCCH .....	79
7.0	General .....	79
7.0a	Support of multiple TBF procedures .....	79
7.0b	(void) .....	79
7.1	TBF establishment initiated by the mobile station on PCCCH .....	79
7.1.1	Permission to access the network .....	80
7.1.2	Initiation of a TBF establishment .....	80
7.1.2.1	Initiation of the packet access procedure .....	80
7.1.2.1.1	Access persistence control on PRACH .....	82
7.1.2.2	Packet assignment procedure .....	83
7.1.2.2.1	On receipt of a PACKET CHANNEL REQUEST or EGPRS PACKET CHANNEL REQUEST message .....	83
7.1.2.2.1a	Acquisition of MS Radio Access Capability information within EGPRS TBF establishment procedure .....	85
7.1.2.2.2	Packet access queuing notification procedure .....	85
7.1.2.2.3	Packet polling procedure .....	86
7.1.2.2.4	Packet access reject procedure .....	86
7.1.2.3	Contention resolution at one phase access .....	87
7.1.2.3a	RLC/MAC procedures during contention resolution .....	87
7.1.2.4	One phase packet access completion .....	88
7.1.2.5	Timing Advance .....	88
7.1.2.6	PFC procedure at one phase access .....	88
7.1.3	TBF establishment using two phase access .....	89
7.1.3.1	Initiation of the Packet resource request procedure .....	89
7.1.3.2	Packet resource assignment for uplink procedure .....	90
7.1.3.2.1	On receipt of a PACKET RESOURCE REQUEST message .....	90
7.1.3.3	Contention resolution at two phase access .....	92
7.1.3.4	Two phase packet access completion .....	92
7.1.3.5	Timing Advance .....	92
7.1.3.6	RTTI Assignments .....	93
7.1.3.7	MTTI Configurations .....	93
7.1.4	Abnormal cases .....	94
7.2	TBF establishment initiated by the network on PCCCH .....	95
7.2.1	Entering the packet transfer mode .....	95
7.2.1.1	Packet downlink assignment procedure .....	95
7.2.1.2	Packet downlink assignment procedure completion .....	96

7.2.1.3	Packet polling procedure.....	97
7.2.2	Abnormal cases.....	97
7.3	Procedure for measurement report sending in packet idle mode.....	97
7.3.1	Measurement report sending procedure initiated on PCCCH.....	97
7.3.1.1	On receipt of a PACKET CHANNEL REQUEST message.....	97
7.3.1.2	On receipt of a PACKET UPLINK ASSIGNMENT message.....	98
7.3.1.3	On receipt of a PACKET ACCESS REJECT message.....	98
7.3.1.4	Abnormal cases.....	98
7.3.2	Measurement report sending procedure initiated on CCCH.....	98
7.4	Cell Change Order procedures in Packet Idle mode.....	99
7.4.1	Cell Change Order procedure initiated on PCCCH.....	99
7.4.2	Cell Change Order procedure initiated on CCCH.....	100
7.5	Measurement Order procedures in Packet Idle mode.....	100
7.5.1	Measurement Order procedures initiated on PCCCH.....	100
7.5.2	Measurement Order procedures initiated on CCCH.....	101
7.6	Packet Pause procedure.....	101
7.6.1	Packet pause procedure initiated on PCCCH.....	101
7.6.1.1	On receipt of a PACKET CHANNEL REQUEST message.....	101
7.6.1.2	On receipt of a PACKET UPLINK ASSIGNMENT message.....	102
7.6.1.3	On receipt of a PACKET ACCESS REJECT message.....	102
7.6.1.4	Abnormal cases.....	102
7.6.2	Packet pause procedure initiated on CCCH.....	102
7.7	MBMS packet access and establishment procedures.....	102
7.7.1	MBMS packet access procedure.....	102
7.7.1.1	General.....	102
7.7.1.2	MBMS packet access procedure on PCCCH.....	103
7.7.1.2.0	Initiation of the MBMS packet access procedure.....	103
7.7.1.2.1	On receipt of a PACKET CHANNEL REQUEST message.....	103
7.7.1.2.2	On receipt of a PACKET UPLINK ASSIGNMENT message.....	103
7.7.1.2.3	On receipt of a PACKET ACCESS REJECT message.....	103
7.7.1.2.4	On receipt of an MBMS ASSIGNMENT message.....	103
7.7.1.2.5	Abnormal cases.....	103
7.7.1.3	MBMS packet access procedure on CCCH.....	104
7.7.1.4	MBMS packet access procedure on MPRACH.....	104
7.7.1.4.1	Initiation of the MBMS packet access procedure on MPRACH.....	104
7.7.1.4.1.1	Access persistence control on MPRACH.....	104
7.7.1.4.2	On receipt of an MPRACH PACKET CHANNEL REQUEST.....	105
7.7.1.4.3	On receipt of a PACKET ACCESS REJECT message.....	105
7.7.1.4.4	On receipt of a PACKET UPLINK ASSIGNMENT message.....	106
7.7.1.4.5	On receipt of an MBMS ASSIGNMENT message.....	106
7.7.2	Establishment of MBMS bearer.....	106
7.7.2.1	General.....	106
7.7.2.2	On receipt of an MBMS ASSIGNMENT message.....	107
7.7.2.3	Abnormal cases.....	108
7.7.2.4	MBMS address assignment procedure.....	108
7.7.3	MBMS Neighbour Cell Information Distribution.....	109
8	Medium Access Control (MAC) Procedures in Packet Transfer Mode.....	110
8.0	General.....	110
8.1	Transfer of RLC data blocks.....	110
8.1.0	Medium access mode.....	110
8.1.1	Uplink RLC data block transfer.....	110
8.1.1.1	Dynamic allocation uplink RLC data block transfer.....	117
8.1.1.1.1	PACCH operation.....	118
8.1.1.1.2	Resource Reallocation for Uplink.....	119
8.1.1.1.2.1	Abnormal cases.....	121
8.1.1.1.3	Establishment of Downlink TBF.....	122
8.1.1.1.3.1	Abnormal cases.....	124
8.1.1.2	Extended Dynamic Allocation uplink RLC data block transfer.....	125
8.1.1.2.1	Uplink PDCH Allocation.....	126
8.1.1.2.2	PACCH operation.....	128
8.1.1.2.3	Neighbour cell power measurements.....	129

8.1.1.2.4	Shifted USF operation .....	129
8.1.1.3	(void).....	130
8.1.1.3a	Exclusive allocation RLC data block transfer .....	130
8.1.1.3a.1	General .....	130
8.1.1.3a.2	Radio link failure.....	130
8.1.1.3a.3	(void) .....	131
8.1.1.3a.4	PACCH operation.....	131
8.1.1.3a.5	Resource Reallocation for Uplink .....	131
8.1.1.3a.5.1	General.....	131
8.1.1.3a.5.2	Change of service demand .....	131
8.1.1.3a.5.3	Reallocation of radio resources for an uplink TBF .....	132
8.1.1.3a.5.4	Rejection of new service demand .....	132
8.1.1.3a.5.5	Abnormal cases.....	132
8.1.1.3a.6	Establishment of Downlink TBF .....	133
8.1.1.3a.6.1	General.....	133
8.1.1.3a.6.2	Abnormal cases.....	133
8.1.1.4	Network initiated release of uplink TBF.....	134
8.1.1.5	Abnormal cases .....	134
8.1.1.6	Change of RLC mode in extended uplink TBF mode.....	135
8.1.1.6.1	General .....	135
8.1.1.6.2	Change of RLC mode.....	135
8.1.1.6.3	Abnormal cases .....	135
8.1.1.7	Change of EGPRS level .....	135
8.1.1.7.1	Change of EGPRS level for downlink TBFs.....	135
8.1.1.7.2	Change of EGPRS level for uplink TBFs.....	135
8.1.2	Downlink RLC data block transfer .....	139
8.1.2.1	Downlink RLC data block transfer .....	140
8.1.2.1.1	Abnormal cases .....	141
8.1.2.2	Polling for Packet Downlink Ack/Nack.....	143
8.1.2.3	(void).....	144
8.1.2.4	Resource Reassignment for Downlink .....	144
8.1.2.4.1	Abnormal cases .....	145
8.1.2.5	Establishment of uplink TBF .....	146
8.1.2.5.1	Abnormal cases .....	148
8.1.2.6	(void).....	149
8.1.2.7	(void).....	149
8.1.2.8	Network initiated abnormal release of downlink TBF .....	149
8.1.3	(void) .....	150
8.1.4	RLC data block transfer during an MBMS radio bearer.....	150
8.1.4.0	General .....	150
8.1.4.1	RLC data block transfer during an MBMS radio bearer .....	150
8.1.4.2	Polling for MBMS Downlink Ack/Nack.....	150
8.1.4.3	Reconfiguration of an MBMS radio bearer.....	151
8.1.4.3.1	Individual reassignment of an MS_ID.....	151
8.1.4.3.2	Reassignment of the MBMS Bearer Identity.....	151
8.1.4.3.3	Resource reassignment for an MBMS radio bearer.....	153
8.1.4.4	Network initiated release of an MBMS radio bearer.....	154
8.1.4.5	Suspension/Resumption of the reception of an MBMS radio bearer .....	154
8.1.5	Multiple MBMS radio bearers.....	155
8.1.5.1	Transmission of multiple MBMS radio bearers .....	155
8.1.5.2	Reception of multiple MBMS radio bearers .....	155
8.1.5.2.1	General .....	155
8.1.5.2.2	Reception of notification of lower priority MBMS session whilst receiving higher priority MBMS session(s) .....	155
8.1.5.2.3	Reception of assignment of lower priority MBMS session whilst receiving higher priority MBMS session(s) .....	155
8.1.5.2.4	Reception of notification of higher priority MBMS session whilst receiving lower priority MBMS session(s) .....	156
8.1.5.2.5	Reception of assignment of higher priority MBMS session whilst receiving lower priority MBMS session(s) .....	156
8.1.5.2.6	Cell change whilst receiving multiple MBMS sessions (with MBMS supported by the network in the target cell).....	156



8.1.5.2.7	Resource reassignment for at least one of the received MBMS radio bearers.....	156
8.1.6	MBMS reception resumption after cell reselection .....	157
8.1.6.1	Default behaviour.....	157
8.1.6.2	Fast reception resumption .....	157
8.1.7	Packet Application Information.....	158
8.1.7.1	General.....	158
8.1.7.2	Earthquake and Tsunami Warning System (ETWS).....	158
8.1.8	Dynamic Timeslot Reduction .....	158
8.1.8.1	General.....	158
8.1.8.2	DTR Activation.....	158
8.1.8.3	Resumption to normal operation .....	159
8.2	Packet PDCH Release .....	160
8.3	Procedure for measurement report sending in Packet Transfer mode .....	160
8.4	Network controlled cell reselection procedure.....	160
8.4.1	Network controlled cell reselection completion .....	161
8.4.1b	(void) .....	161
8.4.2	Abnormal cases.....	161
8.5	Measurement Order procedures in Packet Transfer mode.....	162
8.6	PACKET CONTROL ACKNOWLEDGEMENT .....	162
8.7	Abnormal cases .....	163
8.7.0	General.....	163
8.7.1	Abnormal release without retry .....	164
8.7.2	Abnormal release with access retry .....	164
8.7.3	Abnormal release with system information .....	164
8.7.4	Abnormal release with RR connection establishment retry .....	165
8.8	Network Assisted Cell Change procedures .....	165
8.8.1	Neighbour Cell System Information Distribution.....	165
8.8.2	CCN setting procedure.....	166
8.8.2a	CCN support description .....	167
8.8.3	Cell Change Notification procedure .....	167
8.9	RR connection establishment in packet transfer mode.....	169
8.9.0	General.....	169
8.9.1	Initiation.....	170
8.9.1.1	Initiation by the mobile station.....	170
8.9.1.1.1	Transmission of the PACKET CS REQUEST message.....	170
8.9.1.1.2	Answer from the network .....	170
8.9.1.2	Initiation by the network .....	170
8.9.2	Assignment .....	171
8.9.2.1	Assignment of both dedicated and packet resource .....	171
8.9.2.2	Assignment of dedicated resource only.....	171
8.9.2.3	Rejection of the mobile station request .....	171
8.9.3	(void) .....	172
8.9.4	Abnormal cases.....	172
8.9.4.1	RR connection establishment initiated by the mobile station.....	172
8.9.4.2	RR connection establishment initiated by the network .....	172
8.10	Packet Switched Handover procedure.....	173
8.10.1	General.....	173
8.10.2	Neighbour Cell System Information Distribution.....	173
8.10.3	PS Handover at the network side .....	174
8.10.3.1	Initiation of PS Handover Procedure.....	174
8.10.3.2	A/Gb to A/Gb PS Handover.....	174
8.10.3.3	GERAN A/Gb to Iu/E-UTRAN PS Handover .....	175
8.10.3.4	Iu/E-UTRAN to GERAN A/Gb PS Handover .....	176
8.10.3.5	A/Gb to GAN PS Handover .....	176
8.10.3.6	GAN to A/Gb PS Handover .....	176
8.10.4	PS Handover at the mobile station side .....	176
8.10.4.1	A/Gb to A/Gb PS Handover.....	176
8.10.4.2	A/Gb to Iu/E-UTRAN PS Handover.....	177
8.10.4.3	Iu/E-UTRAN to A/Gb PS Handover.....	177
8.10.4.4	Physical channel establishment.....	178
8.10.4.4.1	General .....	178
8.10.4.4.2	Synchronized cell case .....	178

8.10.4.4.3	Pre-synchronized cell case.....	178
8.10.4.4.4	Non synchronized cell case .....	179
8.10.4.5	A/Gb to GAN PS Handover .....	179
8.10.4.6	GAN to A/Gb PS Handover .....	179
8.10.5	Abnormal Cases .....	180
8.10.5.1	MS Behaviour for A/Gb to A/Gb PS Handover.....	180
8.10.5.2	MS Behaviour for A/Gb to Iu/E-UTRAN PS Handover.....	181
8.10.5.3	MS Behaviour for Iu/E-UTRAN to A/Gb PS Handover.....	181
8.10.5.4	BSS Behaviour for PS Handover from A/Gb.....	181
8.10.5.5	BSS Behaviour for PS Handover to A/Gb .....	182
8.10.5.6	MS Behaviour for A/Gb to GAN PS Handover .....	182
8.10.5.7	MS Behaviour for GAN to A/Gb PS Handover .....	182
9	Radio Link Control (RLC) procedures in packet transfer mode .....	182
9.0	General .....	182
9.1	Procedures and parameters for peer-to-peer operation.....	183
9.1.1	Send state variable V(S) .....	184
9.1.1a	Control send state variable V(CS) .....	184
9.1.2	Acknowledge state variable V(A).....	184
9.1.3	Acknowledge state array V(B).....	185
9.1.3.1	Acknowledge state array V(B) for GPRS TBF Mode.....	185
9.1.3.2	Acknowledge State Array V(B) for EGPRS TBF Mode.....	185
9.1.3.2.1	EGPRS TBF running in RLC acknowledged mode .....	185
9.1.3.2.2	EGPRS TBF running in RLC non-persistent mode .....	186
9.1.3.3	Acknowledge State Array V(B) for MBMS Bearers .....	187
9.1.4	Block sequence number BSN .....	187
9.1.4.1	Block sequence number BSN for GPRS TBF.....	187
9.1.4.2	Block sequence number BSN for EGPRS TBF .....	187
9.1.4a	Reduced Block Sequence Number RBSN .....	187
9.1.4b	Reduced Block Sequence Number extension RBSNe .....	188
9.1.5	Receive state variable V(R) .....	188
9.1.6	Receive window state variable V(Q) .....	188
9.1.6.1	General .....	188
9.1.6.2	RLC acknowledged mode .....	188
9.1.6.3	RLC unacknowledged mode .....	188
9.1.6.4	RLC non-persistent mode .....	188
9.1.7	Receive state array V(N).....	189
9.1.7.1	Receive state array V(N) in GPRS TBF.....	189
9.1.7.2	Receive state array V(N) in EGPRS TBF .....	189
9.1.7.3	Receive state array V(N) in TBF with FANR activated.....	189
9.1.8	Starting sequence number (SSN) and received block bitmap (RBB) .....	190
9.1.8.1	Starting sequence number (SSN) and received block bitmap (RBB) in GPRS TBF.....	190
9.1.8.2	Starting sequence number (SSN) and received block bitmap (RBB) in EGPRS TBF .....	191
9.1.8.2.1	Extended Polling .....	191
9.1.8.2.2	Determination of SSN .....	194
9.1.8.2.2a	Determination of ShortSSN and SSN in the Piggy-backed Ack/Nack field.....	196
9.1.8.2.3	Generation of the bitmap .....	196
9.1.8.2.4	Interpretation of the bitmap.....	198
9.1.9	Window Size.....	199
9.1.9.1	GPRS.....	199
9.1.9.2	EGPRS .....	199
9.1.9.3	RLC buffer .....	201
9.1.10	Compression .....	201
9.1.11	Segmentation of upper layer PDUs into RLC data units .....	204
9.1.12	Re-assembly of upper layer PDUs from RLC data units .....	204
9.1.12a	Segmentation of RLC/MAC control messages into RLC/MAC control blocks .....	207
9.1.12b	Re-assembly of RLC/MAC control messages from RLC/MAC control blocks .....	207
9.1.13	Priority of upper layer PDUs .....	208
9.1.14	Fast Ack/Nack Reporting.....	208
9.1.14.1	General .....	208
9.1.14.2	Polled Fast Ack/Nack Reporting.....	209
9.1.14.3	Event-based Fast Ack/Nack Reporting .....	209

9.1.15	Time-based encoding of the Piggy-backed Ack/Nack field.....	210
9.1.15.1	Generation of the bitmap.....	210
9.1.15.2	Interpretation of the bitmap.....	211
9.2	Operation during RLC/MAC control message transfer.....	211
9.3	Operation during RLC data block transfer.....	212
9.3.0	General.....	212
9.3.1	Countdown procedure.....	212
9.3.1.1	General.....	212
9.3.1.2	Non-extended uplink TBF mode.....	213
9.3.1.3	Extended uplink TBF mode.....	214
9.3.1a	Delayed release of downlink Temporary Block Flow.....	214
9.3.1b	Extended uplink TBF mode.....	214
9.3.1b.1	Application.....	214
9.3.1b.2	Operation of uplink TBF in extended uplink TBF mode.....	215
9.3.2	Acknowledged mode operation.....	215
9.3.2.0	General.....	215
9.3.2.1	Additional functionality in acknowledged EGPRS TBF Mode.....	216
9.3.2.2	Establishment of Temporary Block Flow.....	217
9.3.2.3	Operation of uplink Temporary Block Flow.....	217
9.3.2.4	Release of uplink Temporary Block Flow.....	218
9.3.2.4.1	General.....	218
9.3.2.4.2	Non-extended uplink TBF mode.....	218
9.3.2.5	Operation of downlink Temporary Block Flow.....	219
9.3.2.6	Release of downlink Temporary Block Flow.....	220
9.3.3	Unacknowledged mode operation.....	221
9.3.3.0	General.....	221
9.3.3.1	Establishment of Temporary Block Flow.....	221
9.3.3.2	Operation of uplink Temporary Block Flow.....	221
9.3.3.3	Release of uplink Temporary Block Flow.....	222
9.3.3.3.1	General.....	222
9.3.3.3.2	Non-extended uplink TBF mode.....	222
9.3.3.4	Operation of downlink Temporary Block Flow.....	223
9.3.3.5	Release of downlink Temporary Block Flow.....	223
9.3.4	Non-persistent mode operation.....	225
9.3.4.0	General.....	225
9.3.4.1	Operation during an MBMS bearer.....	225
9.3.4.2	Release of an MBMS radio bearer.....	225
9.3.4.3	Operation during an EGPRS TBF.....	225
9.4	Abnormal release cases.....	225
9.4.1	Abnormal release with access retry.....	225
9.4.2	Abnormal release with cell reselection.....	225
9.5	Uplink TBF release in extended uplink TBF mode.....	226
10	RLC/MAC block structure.....	227
10.0a	RLC/MAC block structure.....	227
10.0a.1	GPRS RLC/MAC block for data transfer.....	227
10.0a.2	EGPRS RLC/MAC block for data transfer.....	227
10.0a.3	RLC/MAC block for control message transfer.....	229
10.0b	RLC/MAC block format conventions.....	229
10.0b.1	Numbering convention.....	229
10.0b.2	Assembling conventions.....	229
10.0b.2.1	Assembling convention for GPRS RLC data blocks and RLC/MAC control blocks, 11-bit and 8-bit control messages.....	230
10.0b.2.2	Assembling convention for EGPRS RLC data blocks.....	230
10.0b.3	Field mapping conventions.....	230
10.0b.3.1	Field mapping convention for GPRS RLC data blocks, CS-1 or CS-3 encoded RLC/MAC control blocks, 11-bit and 8-bit control messages.....	230
10.0b.3.2	Field mapping convention for EGPRS RLC data blocks and MCS-0 encoded RLC/MAC control blocks.....	230
10.1	Spare bits.....	231
10.2	GPRS RLC data blocks.....	231
10.2.1	Downlink RLC data block.....	231

10.2.2	Uplink RLC data block .....	232
10.3	RLC/MAC control blocks .....	232
10.3.1	Downlink RLC/MAC control block .....	233
10.3.1.1	Blocks encoded using CS-1 .....	233
10.3.1.2	Blocks encoded using MCS-0 .....	233
10.3.2	Uplink RLC/MAC control block .....	234
10.3a	EGPRS RLC data blocks and RLC/MAC headers .....	234
10.3a.0	General.....	234
10.3a.1	EGPRS downlink RLC data block.....	237
10.3a.2	EGPRS Uplink RLC data block.....	238
10.3a.3	EGPRS Downlink RLC/MAC header .....	238
10.3a.3.1	Header type 1: header for MCS-7, MCS-8 and MCS-9 .....	238
10.3a.3.2	Header type 2: header for MCS-6, MCS-5, DAS-5, DAS-6 and DAS-7 .....	239
10.3a.3.3	Header type 3: header for MCS-4, MCS-3, MCS-2, MCS-1 and MCS-0 case .....	240
10.3a.3.4	Header type 4: header for DAS-8 and DAS-9.....	242
10.3a.3.5	Header type 5: header for DAS-11 and DAS-12.....	242
10.3a.3.6	Header type 6: header for DBS-5 and DBS-6 .....	243
10.3a.3.7	Header type 7: header for DBS-7 and DBS-8 .....	243
10.3a.3.8	Header type 8: header for DBS-9 and DBS-10 .....	243
10.3a.3.9	Header type 9: header for DBS-11 and DBS-12 .....	244
10.3a.3.10	Header type 10: header for DAS-10.....	244
10.3a.4	EGPRS Uplink RLC/MAC header .....	245
10.3a.4.1	Header type 1: header for MCS-7, MCS-8 and MCS-9 .....	245
10.3a.4.2	Header type 2: header for MCS-6 and MCS-5.....	245
10.3a.4.3	Header type 3 : header for MCS-4, MCS-3, MCS-2 and MCS-1 .....	246
10.3a.4.4	Header type 4: header for UAS-7, UAS-8 and UAS-9 .....	246
10.3a.4.5	Header type 5: header for UAS-10 and UAS-11.....	247
10.3a.4.6	Header type 6: header for UBS-5 and UBS-6 .....	247
10.3a.4.7	Header type 7: header for UBS-7 and UBS-8 .....	247
10.3a.4.8	Header type 8: header for UBS-9 and UBS-10 .....	247
10.3a.4.9	Header type 9: header for UBS-11 and UBS-12 .....	248
10.3a.5	Piggy-backed Ack/Nack field (SSN-based) .....	248
10.3a.6	Piggy-backed Ack/Nack field (Time-based) .....	249
10.4	Header fields .....	249
10.4.1	Uplink state flag (USF) field.....	249
10.4.2	Retry (R) bit.....	249
10.4.3	Stall indicator (SI) bit .....	249
10.4.4	Supplementary/Polling (S/P) Bit.....	250
10.4.4a	EGPRS Supplementary/Polling (ES/P) Field .....	250
10.4.4b	Combined EGPRS Supplementary/Polling (CES/P) Field .....	250
10.4.5	Relative Reserved Block Period (RRBP) field .....	251
10.4.5.1	Special requirements in dual transfer mode .....	254
10.4.6	Countdown Value (CV) field.....	254
10.4.7	Payload Type field.....	254
10.4.8	Final block indicator (FBI) bit.....	255
10.4.8a	Coding and Puncturing Scheme indicator field (CPS).....	255
10.4.8a.1	Header type 1 .....	256
10.4.8a.2	Header type 2 .....	256
10.4.8a.3	Header type 3 .....	258
10.4.8a.4	Header type 4 .....	258
10.4.8a.5	Header type 5 .....	259
10.4.8a.6	Header type 6 .....	260
10.4.8a.7	Header type 7 .....	261
10.4.8a.8	Header type 8 .....	262
10.4.8a.9	Header type 9 .....	264
10.4.8a.10	Header type 10 .....	266
10.4.8b	Split Block indicator field (SPB) .....	267
10.4.9	TLLI Indicator (TI) bit.....	267
10.4.9a	Address Control (AC) bit.....	267
10.4.9b	Final Segment (FS) bit.....	268
10.4.9c	Radio Transaction Identifier (RTI) field.....	268
10.4.9d	Direction (D) bit .....	268

10.4.9e	Final Segment extension (FSe) bit.....	268
10.4.10	Temporary Flow Identity (TFI) field .....	269
10.4.10a	Power Reduction (PR) field.....	269
10.4.11	Extension (E) Bit .....	269
10.4.12	Block Sequence Number (BSN) field.....	270
10.4.12a	Reduced Block Sequence Number (RBSN) bit .....	271
10.4.12b	Reduced Block Sequence Number extension (RBSNe) field .....	271
10.4.13	More (M) bit .....	271
10.4.14	Length Indicator (LI) field in GPRS TBF mode and DCCH TBF mode ( <i>Iu mode</i> ) .....	271
10.4.14a	Length Indicator (LI) field in EGPRS TBF mode and TCH TBF mode ( <i>Iu mode</i> ) .....	272
10.4.15	TLLI field .....	274
10.4.16	RLC data field.....	275
10.4.17	Control message contents field .....	275
10.4.18	Resent Block Bit (RSB).....	275
10.4.19	PFI Indicator (PI) bit.....	275
10.4.20	Packet Flow Identifier (PFI) field.....	275
10.4.21	PAN Indication (PANI) field.....	275
10.4.22	Beginning of Window (BOW) field .....	276
10.4.23	Short Starting Sequence Number (ShortSSN) field .....	276
10.4.24	Carrier ID (CI) field.....	276
10.4.25	TN/PDCH-pair field .....	276
10.4.26	DTR Blks.....	276
10.4.27	Selected PLMN Index field .....	276
11	Message functional definitions and contents.....	277
11.1	Handling of erroneous protocol data .....	278
11.1.1	Message classification .....	278
11.1.1.1	Distribution messages .....	278
11.1.1.2	Non-distribution messages .....	279
11.1.1.2.1	Format of the address information.....	279
11.1.1.3	DBPSCH message ( <i>Iu mode only</i> ).....	279
11.1.2	Error detection mechanism .....	280
11.1.3	Error labels.....	280
11.1.3.1	Generic error labels .....	280
11.1.3.2	'Ignore' error label .....	280
11.1.3.3	'Message escape' error label .....	281
11.1.4	Error detection and order of precedence .....	281
11.1.4.1	Unknown message type.....	281
11.1.4.2	Message not compatible with current protocol state .....	282
11.1.4.3	Syntactically incorrect message .....	282
11.1.4.3.1	Messages with error label: 'Distribution part error' .....	282
11.1.4.3.2	Messages with error label: 'Address information part error' .....	282
11.1.4.3.3	Messages with error label: 'Non-distribution part error' .....	282
11.1.4.3.4	Messages with error label: 'Message escape' .....	282
11.1.4.3.5	Messages with error label: 'Ignore' .....	283
11.1.4.3.6	Messages with error label: "DBPSCH message part error" .....	283
11.1.4.4	Syntactic error in truncated concatenation .....	283
11.1.4.5	(void).....	284
11.2	RLC/MAC control messages.....	284
11.2.0	Message format.....	285
11.2.0.1	Downlink RLC/MAC messages.....	286
11.2.0.2	Uplink RLC/MAC messages.....	287
11.2.1	Packet Access Reject .....	287
11.2.2	Packet Control Acknowledgement .....	290
11.2.2a	Packet Cell Change Continue .....	292
11.2.3	Packet Cell Change Failure.....	293
11.2.3a	Packet Cell Change Notification.....	295
11.2.4	Packet Cell Change Order.....	298
11.2.5	Packet Channel Request.....	305
11.2.5a	EGPRS Packet Channel Request .....	307
11.2.5b	Packet DBPSCH Assignment .....	309
11.2.5c	MPRACH Packet Channel Request.....	313

11.2.6	Packet Downlink Ack/Nack.....	313
11.2.6a	EGPRS Packet Downlink Ack/Nack .....	316
11.2.6b	Packet DBPSCH Downlink Ack/Nack .....	318
11.2.6c	Packet DBPSCH Downlink Ack/Nack Type 2 .....	319
11.2.6d	MBMS Downlink Ack/Nack .....	320
11.2.6e	EGPRS Packet Downlink Ack/Nack Type 2 .....	323
11.2.6f	EGPRS Packet Downlink Ack/Nack Type 3 .....	324
11.2.7	Packet Downlink Assignment.....	325
11.2.7.1	Special requirements in dual transfer mode for downlink TBF .....	337
11.2.7a	Multiple TBF Downlink Assignment .....	337
11.2.8	Packet Downlink Dummy Control Block .....	343
11.2.8b	Packet Uplink Dummy Control Block.....	344
11.2.9	Packet Measurement Report .....	344
11.2.9b	Packet Measurement Order.....	347
11.2.9b.1	GPRS REP PRIORITY description .....	362
11.2.9c	Packet Mobile TBF Status .....	362
11.2.9d	Packet Enhanced Measurement Report.....	362
11.2.9e	Packet Neighbour Cell Data.....	365
11.2.10	Packet Paging Request.....	367
11.2.11	Packet PDCH Release.....	373
11.2.12	Packet Polling Request .....	373
11.2.13	Packet Power Control/Timing Advance .....	374
11.2.14	Packet PRACH Parameters.....	376
11.2.15	Packet Queuing Notification.....	376
11.2.16	Packet Resource Request .....	377
11.2.17	Packet PSI Status .....	381
11.2.17a	Packet Serving Cell Data .....	382
11.2.17b	Packet SI Status .....	384
11.2.17c	Packet Serving Cell SI .....	387
11.2.18	Packet System Information Type 1.....	388
11.2.19	Packet System Information Type 2.....	390
11.2.19.1	Reference Frequency Lists in PSI2 .....	394
11.2.19.2	Cell Allocation in PSI2 .....	394
11.2.19.3	GPRS Mobile Allocation in PSI2.....	394
11.2.19.4	PCCCH Description .....	394
11.2.19.5	Abnormal cases .....	394
11.2.20	Packet System Information Type 3.....	394
11.2.21	Packet System Information Type 3 bis .....	404
11.2.21a	Packet System Information Type 3 ter.....	408
11.2.21a.1	GPRS REP PRIORITY description .....	410
11.2.21b	Packet System Information Type 3 quater.....	410
11.2.21b.1	GPRS REP PRIORITY description .....	414
11.2.22	(void) .....	414
11.2.23	Packet System Information Type 5.....	414
11.2.23a	Packet System Information Type 6.....	418
11.2.23b	Packet System Information Type 7.....	419
11.2.24	Packet System Information Type 8.....	419
11.2.25	Packet System Information 13 .....	421
11.2.25a	Packet System Information 14 .....	425
11.2.25b	Packet System Information 15 .....	427
11.2.25c	Packet System Information Type 16.....	427
11.2.26	Packet TBF Release .....	429
11.2.27	(void) .....	430
11.2.28	Packet Uplink Ack/Nack .....	430
11.2.28a	Packet DBPSCH Uplink Ack/Nack .....	433
11.2.28b	Packet DBPSCH Uplink Ack/Nack Type 2 .....	435
11.2.29	Packet Uplink Assignment.....	436
11.2.29.1	Special requirements in dual transfer mode for uplink TBF .....	448
11.2.29a	Multiple TBF Uplink Assignment .....	449
11.2.30	(void) .....	458
11.2.30a	Packet Pause .....	458
11.2.31	Packet Timeslot Reconfigure.....	459

11.2.31.1	Special requirements in dual transfer mode .....	474
11.2.31a	Multiple TBF Timeslot Reconfigure .....	475
11.2.32	Additional MS Radio Access Capabilities .....	485
11.2.33	Handover Access ( <i>Iu mode only</i> ) .....	485
11.2.34	Physical Information ( <i>Iu mode only</i> ) .....	486
11.2.35	Packet CS Request .....	486
11.2.36	Packet CS Command .....	487
11.2.37	Packet CS Release Indication .....	488
11.2.38	MBMS Service Request .....	496
11.2.39	MBMS Assignment (Non-distribution) .....	497
11.2.39a	MBMS Assignment (Distribution) .....	499
11.2.40	MBMS Neighbouring Cell Information .....	501
11.2.41	MBMS MS_ID Assignment .....	505
11.2.42	Packet MBMS Announcement .....	506
11.2.43	PS Handover Command .....	508
11.2.44	PS Handover Access .....	511
11.2.45	Packet Physical Information ( <i>A/Gb mode only</i> ) .....	512
11.2.46	DTM Handover Command .....	512
11.2.47	Packet Application Information .....	514
11.2.48	EGPRS Packet Downlink Ack/Nack DLMC .....	514
12	Information element coding .....	516
12.1	Overview .....	516
12.2	(void) .....	516
12.3	Ack/Nack Description .....	516
12.3.1	EGPRS Ack/Nack Description .....	516
12.3.2	FLO Ack/Nack Description .....	518
12.3.3	EGPRS Ack/Nack Description DLMC .....	519
12.4	(void) .....	521
12.5	EGPRS .....	521
12.5.1	EGPRS Channel Quality Report .....	521
12.5.2	EGPRS Window Size .....	521
12.5.3	EGPRS BEP Link Quality Measurements IE .....	523
12.5.4	EGPRS Timeslot Link Quality Measurements IE .....	524
12.5.5	PDCH Pairs Description .....	525
12.5a	EGPRS2 .....	526
12.5a.1	EGPRS Channel Quality Report Type 2 .....	526
12.5a.2	EGPRS BEP Link Quality Measurements Type 2 IE .....	527
12.5a.3	EGPRS Timeslot Link Quality Measurements Type 2 IE .....	528
12.6	(void) .....	530
12.7	Channel Request Description .....	530
12.7a	<i>Iu mode</i> Channel Request Description .....	531
12.7b	Extended Channel Request Description .....	532
12.8	Frequency Parameters .....	532
12.8.1	Abnormal cases .....	534
12.8.2	Dual Carrier Frequency Parameters .....	534
12.8.3	Pulse Format description .....	535
12.8.4	DLMC Frequency Parameters .....	537
12.9	Global Power Control Parameters .....	538
12.9a	GPRS Power Control Parameters .....	539
12.10	Global TFI .....	539
12.10a	GPRS Mobile Allocation .....	539
12.10a.1	Abnormal cases .....	541
12.10b	(void) .....	541
12.10c	(void) .....	541
12.10d	EGPRS Modulation and coding Scheme description .....	541
12.10e	RESEGMENT description .....	542
12.10f	EGPRS Level description .....	542
12.11	Packet Request Reference .....	543
12.12	Packet Timing Advance .....	543
12.12a	Global Packet Timing Advance .....	544
12.12b	Packet Extended Timing Advance .....	545

12.13	Power Control Parameters.....	545
12.14	PRACH Control Parameters.....	546
12.15	Temporary Flow Identity (TFI).....	548
12.16	Temporary Logical Link Identity (TLLI)/G-RNTI.....	549
12.16a	GERAN Radio Network Temporary Identity (G-RNTI).....	549
12.17	Temporary Queueing Identifier (TQI).....	549
12.18	TIMESLOT_ALLOCATION.....	550
12.19	(void).....	550
12.20	PAGE_MODE.....	550
12.21	Starting Frame Number Description.....	550
12.21.1	Absolute Frame Number Encoding.....	550
12.21.2	Relative Frame Number Encoding.....	551
12.22	(void).....	551
12.23	Cell Identification.....	551
12.24	GPRS Cell Options.....	552
12.25	PCCCH Organization Parameters.....	556
12.26	Extension Bits IE.....	556
12.27	Non GPRS Cell Options IE.....	557
12.28	LSA Parameters.....	558
12.29	COMPACT reduced MA.....	558
12.30	MS Radio Access Capability 2.....	559
12.31	UTRAN FDD Target cell.....	560
12.32	UTRAN TDD Target cell.....	561
12.33	Temporary Mobile Group Identity (TMGI).....	562
12.34	MBMS Bearer Identity.....	563
12.35	MS_ID.....	563
12.36	MBMS Channel Parameters.....	563
12.37	MBMS p-t-m channel description.....	564
12.38	MPRACH description.....	564
12.39	MBMS Sessions List.....	565
12.40	MBMS Session Parameters List.....	565
12.41	MPRACH Control Parameters.....	566
12.42	PS Handover Radio Resources.....	567
12.42a	PS Handover Radio Resources 2.....	572
12.42b	PS Handover Radio Resources 3.....	575
12.43	NAS Container for PS Handover.....	581
12.44	Estimated Session Duration.....	581
12.45	MBMS In-band Signalling Indicator.....	582
12.45a	NPM Transfer Time.....	582
12.45b	RRC Container.....	583
12.46	DTM Handover PS Radio Resources.....	584
12.47	DTM Handover CS Radio Resources.....	588
12.48	DTM Handover PS Radio Resources 2.....	589
12.48a	PS resources assignment information elements.....	592
12.48a.1	EGPRS mode 2.....	592
12.48a.2	Single Downlink Assignment 2.....	592
12.48a.3	Single Uplink Assignment 2.....	594
12.48a.4	Dynamic Allocation 2.....	595
12.48a.5	Multiple Downlink Assignment 2.....	598
12.48a.6	Multiple Uplink Assignment 2.....	601
12.49	E-UTRAN Target Cell.....	606
12.50	Individual Priorities.....	607
12.51	GSM Priority Parameters.....	608
12.52	3G Priority Parameters.....	609
12.53	E-UTRAN Parameters.....	610
12.54	3G CSG Description.....	612
12.55	E-UTRAN CSG Description.....	613
12.56	Measurement Control Parameters Description.....	613
12.57	PCID Group.....	614
12.58	PSC Group.....	615
12.59	Enhanced Cell Reselection Parameters.....	615
12.60	E-UTRAN CSG Measurement Report.....	616



12.61	UTRAN CSG Measurement Report.....	617
12.62	E-UTRAN CSG Target cell.....	618
12.63	UTRAN CSG Target cell .....	619
12.64	DTM Handover PS Radio Resources 3 .....	619
12.65	Dynamic Allocation 3 .....	622
12.66	DLMC Channel Quality Report .....	623
12.67	DOWNLINK_eTFL_ASSIGNMENT.....	626
13	Timers and counters .....	627
13.1	Timers on the Mobile Station side.....	628
13.2	Timers on the network side .....	638
13.3	Counters on the Mobile Station side .....	640
13.4	Counters on the Network side .....	640
<b>Annex A (informative):</b>	<b>Bibliography.....</b>	<b>642</b>
<b>Annex B (informative):</b>	<b>RLC data block encoding.....</b>	<b>643</b>
B.1	Example 1.....	643
B.2	Example 2.....	643
B.3	Example 3.....	644
B.4	Example 4.....	646
B.5	Example 5.....	647
B.6	Example 6.....	647
B.7	Example 7.....	648
B.8	RLC data block delimitation for EGPRS .....	649
B.8.1	Example 1 .....	649
B.8.2	Example 2 .....	650
B.8.3	Example 3 .....	652
B.8.4	Example 4.....	653
<b>Annex C (informative):</b>	<b>Message Sequence Diagrams .....</b>	<b>655</b>
<b>Annex D (informative):</b>	<b>(void) .....</b>	<b>656</b>
<b>Annex E (informative):</b>	<b>(void) .....</b>	<b>657</b>
<b>Annex F (informative):</b>	<b>Examples of Countdown procedure operation.....</b>	<b>658</b>
F.1	Example 1.....	659
F.2	Example 2.....	660
F.3	Example 3.....	661
<b>Annex G (informative):</b>	<b>Handling of erroneous protocol data, examples.....</b>	<b>662</b>
G.1	Application of error labels.....	662
G.2	Application of the 'Message escape' error label.....	663
G.3	Application of truncated concatenation including 'padding bits' .....	664
G.4	Message extension using 'padding bits' .....	665
G.5	Message extension using the Extension Bits IE .....	666
<b>Annex H (informative):</b>	<b>(void) .....</b>	<b>667</b>
<b>Annex I (informative):</b>	<b>EGPRS RLC Window Sizes.....</b>	<b>668</b>
<b>Annex J (informative):</b>	<b>An example of MCS-8 retransmission .....</b>	<b>670</b>
J.1	Original MCS-8 RLC data block.....	670
J.2	Retransmission in two MCS-6 RLC data blocks .....	671
J.3	Retransmission in four MCS-3 RLC data blocks .....	672
<b>Annex K (informative):</b>	<b>Signalling uplink assignments for Downlink Dual Carrier and/or RTTI or MTTI configurations.....</b>	<b>674</b>
<b>Annex L (informative):</b>	<b>MultislotClassGroup in EGPRS Packet Channel Request .....</b>	<b>676</b>
<b>Annex M (informative):</b>	<b>MTTI Assignments and allocations.....</b>	<b>677</b>

**Annex N (normative): Uplink Radio Block Transmission order for EFTA .....679**  
**Annex O (informative): Change History .....680**  
History .....681

---

# Foreword

This Technical Specification has been produced by the 3<sup>rd</sup> Generation Partnership Project (3GPP).

The present document specifies the procedures used at the radio interface (Reference Point Um, see 3GPP TS 24.002) for the General Packet Radio Service (GPRS) Medium Access Control /Radio Link Control (MAC/RLC) layer within the digital cellular telecommunications system (Phase 2+).

The contents of the present document are subject to continuing work within the TSG and may change following formal TSG approval. Should the TSG modify the contents of the present document, it will be re-released by the TSG with an identifying change of release date and an increase in version number as follows:

Version x.y.z

where:

- x the first digit:
  - 1 presented to TSG for information;
  - 2 presented to TSG for approval;
  - 3 or greater indicates TSG approved document under change control.
- y the second digit is incremented for all changes of substance, i.e. technical enhancements, corrections, updates, etc.
- z the third digit is incremented when editorial only changes have been incorporated in the document.

---

# 1 Scope

## 1.1 General

This document specifies procedures for the following layers of the radio interface (*Um* reference point), the interface between the GSM/EDGE Radio Access Network (GERAN) and the Mobile Station (MS):

- Radio Link Control (RLC)
- Medium Access Control (MAC), including Physical Link Control functions

The procedures apply in *A/Gb mode* and may also apply in *Iu mode* (see 3GPP TS 44.160).

## 1.2 Related documents

The following documents provide information related to this document:

- 3GPP TS 43.064 contains an overview of the GPRS radio interface (*Um* reference point).
- 3GPP TS 44.003 specifies channel types, access capabilities and channel configurations at the *Um* reference point.
- 3GPP TS 44.004 specifies services offered by the physical layer of the *Um* reference point. It also specifies control channels. RLC and MAC use these services and control channels.
- 3GPP TS 24.007 specifies, in general terms, this protocol's structured functions, its procedures and its relationship with other layers and entities. It also specifies the basic message format and error handling applied by layer 3 protocols.
- 3GPP TS 44.018 specifies GPRS procedures when operating on the Common Control Channel (CCCH) or on dedicated channels.
- 3GPP TS 44.064 specifies the Logical Link Control (LLC) layer.
- 3GPP TS 43.051 is an overall description of the GSM/EDGE Radio Access Network (GERAN) in *Iu mode*.
- 3GPP TS 44.160 specifies RLC/MAC procedures specific to *Iu mode*.
- 3GPP TS 51.010 specifies test procedures for radio-interface signalling.

## 1.3 Use of logical control channels

3GPP TS 45.002 defines three similar sets of logical control.

The first set consists of the following logical control channels:

- Broadcast Control Channel (BCCH): downlink only, used to broadcast Cell specific information;
- Paging Channel (PCH): downlink only, used to send page requests to Mobile Stations (MSs);
- Random Access Channel (RACH): uplink only, used to request GPRS resources or a Dedicated Control Channel;
- Access Grant Channel (AGCH): downlink only, used to allocate GPRS resources or a Dedicated Control Channel;

The second set consists of the following logical control channels (Packet Control Channels):

- Packet Broadcast Control Channel (PBCCH): downlink only, used to broadcast Cell specific information (not used, see sub-clause 1.6);

- Packet Paging Channel (PPCH): downlink only, used to send page requests to Mobile Stations (MSs) (not used, see sub-clause 1.6);
- Packet Random Access Channel (PRACH): uplink only, used to request GPRS resources (not used, see sub-clause 1.6);
- Packet Access Grant Channel (PAGCH): downlink only, used to allocate GPRS resources (not used, see sub-clause 1.6);
- Packet Associated Control Channel (PACCH): bi-directional, associated with a Temporary Block Flow (TBF);
- Packet Timing advance control channel uplink (PTCCH/U): used to transmit random access bursts to allow estimation of the timing advance for one MS in transfer state;
- Packet Timing advance control channel downlink (PTCCH/D): used to transmit timing advance updates for several MS. One PTCCH/D is paired with several PTCCH/U's.
- MBMS Packet Random Access Channel (MPRACH): uplink only, used during the initial counting procedure for MBMS.

The third set consists of the following logical control channels (COMPACT control channels):

- COMPACT Packet Broadcast Control Channel (CPBCCCH): downlink only, used to broadcast Cell specific information; This channel broadcasts the same information as the PBCCH, but has a different physical structure (see 3GPP TS 45.002);
- COMPACT Packet Paging Channel (CPPCH): downlink only, used to send page requests to Mobile Stations (MSs) on a COMPACT control channel;;
- COMPACT Packet Random Access Channel (CPRACH): uplink only, used to request GPRS resources on a COMPACT control channel;
- COMPACT Packet Access Grant Channel (CPAGCH): downlink only, used to allocate GPRS resources on a COMPACT control channel;
- Packet Associated Control Channel (PACCH): see above;
- Packet Timing advance control channel uplink (PTCCH/U): see above;
- Packet Timing advance control channel downlink (PTCCH/D): see above.

## 1.4 Use of logical traffic channels

3GPP TS 45.002 defines the following logical traffic channels used by RLC and MAC:

- Traffic Channel (TCH): bidirectional, carries encoded speech or user data using GMSK on a dedicated basic physical subchannel (DBPSCH). TCH can be full-rate (TCH/F) or half-rate (TCH/H).
- Octal Traffic Channel (O-TCH): bidirectional, carries encoded speech using 8-PSK on a DBPSCH. O-TCH can be full-rate (O-TCH/F) or half-rate (O-TCH/H).
- Enhanced Traffic Channel (E-TCH): bidirectional, carries user data using 8-PSK on a DBPSCH.
- Packet Data Traffic Channel (PDTCH): downlink: carries user data using GMSK, 8-PSK, 16-QAM or 32-QAM with normal symbol rate, or QPSK, 16-QAM, or 32-QAM with higher symbol rate on a shared basic physical subchannel (SBPSCH) or a DBPSCH. PDTCHs can be full-rate (PDTCH/F) or half-rate (PDTCH/H).
- Packet Data Traffic Channel (PDTCH) uplink: carries user data using GMSK, 8-PSK, 16-QAM with normal symbol rate, or QPSK, 16-QAM, 32-QAM with higher symbol rate on a shared basic physical subchannel (SBPSCH) or a DBPSCH. PDTCHs can be full-rate (PDTCH/F) or half-rate (PDTCH/H).

## 1.5 Conventions

Unless explicitly stated otherwise, the following conventions apply:

- The notations "further study", "FS" or "FFS" indicate the annotated text is not normative.
- "GPRS" refers to "GPRS and EGPRS".
- "EGPRS" refers to "EGPRS and EGPRS2".
- "EGPRS2" refers to "EGPRS2-A and EGPRS2-B".
- "PBCCH" refers to "PBCCH and CPBCCH".
- "PPCH" refers to "PPCH and CPPCH".
- "PRACH" refers to "PRACH and CPRACH".
- "PAGCH" refers to "PAGCH and CPAGCH".
- References to "PDCH" also apply to "SBPSCH" and vice-versa.
- "MBMS Assignment" refers to either "MBMS ASSIGNMENT (NON-DISTRIBUTION)" or "MBMS ASSIGNMENT (DISTRIBUTION)".

## 1.6 Restrictions

Independently of what is stated elsewhere in this and other 3GPP specifications, mobile station support for PBCCH, PCCCH and PACKET PSI STATUS is optional for A/Gb-mode of operation. The network shall never enable PBCCH and PCCCH.

On PACCH the network may send Packet System Information (PSI) messages PSI13, PSI14 and PSI15 but shall not send any other PSI message.

---

## 2 References

The following documents contain provisions which, through reference in this text, constitute provisions of the present document.

- References are either specific (identified by date of publication, edition number, version number, etc.) or non-specific.
- For a specific reference, subsequent revisions do not apply.
- For a non-specific reference, the latest version applies. In the case of a reference to a 3GPP document (including a GSM document), a non-specific reference implicitly refers to the latest version of that document *in the same Release as the present document*.

- [1] 3GPP TR 21.905: "Vocabulary for 3GPP Specifications".
- [2] 3GPP TS 22.060: "General Packet Radio Service (GPRS); Service Description; Stage 1".
- [3] 3GPP TS 23.003: "Numbering, addressing and identification".
- [4] 3GPP TS 43.013: "Discontinuous Reception (DRX) in the GSM system".
- [5] 3GPP TS 43.064: " Overall description of GPRS radio interface; Stage 2".
- [6] 3GPP TS 24.002: "GSM - UMTS Public Land Mobile Network (PLMN) access reference configuration".
- [7] 3GPP TS 44.003: "Mobile Station - Base Station System (MS-BSS) interface; Channel structures and access capabilities".
- [8] 3GPP TS 44.004: "Layer 1; General requirements".
- [9] 3GPP TS 44.005: "Data Link (DL) layer; General aspects".

- [10] 3GPP TS 24.007: "Mobile radio interface signalling layer 3; General aspects".
- [11] 3GPP TS 44.018: "Mobile radio interface layer 3 specification; Radio Resource Control Protocol".
- [12] 3GPP TS 44.064: " Mobile Station - Serving GPRS Support Node (MS-SGSN) Logical Link Control (LLC) Layer Specification".
- [13] 3GPP TS 45.002: "Multiplexing and multiple access on the radio path".
- [14] 3GPP TS 45.003: "Channel coding".
- [15] 3GPP TS 45.008: "Radio subsystem link control".
- [16] 3GPP TS 45.010: "Radio subsystem synchronization".
- [17] (void)
- [18] (void).
- [19] 3GPP TS 23.060: "General Packet Radio Service (GPRS); Service Description; Stage 2".
- [20] 3GPP TS 25.331: "Radio Resource Control (RRC) protocol specification".
- [21] 3GPP TS 25.133: "Requirements for support of radio resource management (FDD)".
- [22] 3GPP TS 25.123: "Requirements for support of radio resource management (TDD)".
- [23] ITU-T Recommendation T.4: "Standardization of Group 3 facsimile terminals for document transmission".
- [24] 3GPP TS 22.011: "Service accessibility".
- [25] 3GPP TS 25.101: "UE Radio Transmission and Reception (FDD)".
- [26] 3GPP TS 25.102: "UTRA (UE) TDD; Radio transmission and reception".
- [27] 3GPP TS 25.213: "Spreading and modulation (FDD)".
- [28] 3GPP TS 25.223: "Spreading and modulation (TDD)".
- [29] 3GPP TS 25.304: "UE Procedures in Idle Mode and Procedures for Cell Reselection in Connected Mode".
- [30] 3GPP TS 45.005: "Radio transmission and reception".
- [31] 3GPP TS 45.009: "Link adaptation".
- [32] TIA/EIA-IS-2000-5-A: "CDMA 2000 Series".
- [33] 3GPP TS 51.010-1 (Rel-6): "Mobile Station (MS) conformance specification; Part 1: Conformance specification".
- [34] 3GPP TS 51.010-2 (Rel-6): "Mobile Station (MS) conformance specification; Part 2: Protocol Implementation Conformance Statement (ICS); proforma specification".
- [35] 3GPP TS 51.010-3 (Rel-6): "Mobile Station (MS) conformance specification; Part 3: Layer 3 Abstract Test Suite (ATS)".
- [36] 3GPP TS 51.010-4 (Rel-6): "Mobile Station (MS) conformance specification; Part 4: SIM application toolkit conformance specification".
- [37] 3GPP TS 51.021: "Base Station System (BSS) equipment specification; Radio aspects".
- [38] 3GPP TS 43.051: "GSM/EDGE Radio Access Network (GERAN); Overall Description - Stage 2".
- [39] 3GPP TS 44.160: "Mobile Station (MS) - Base Station System (BSS) interface; Radio Link Control/ Medium Access Control (RLC/MAC) protocol in *Iu mode*".

- [40] Michel MOULY, "CSN.1 Specification, Version 2.0", Cell & Sys, ISBN: 2-9510062-0-9.  
Web: <http://perso.wanadoo.fr/cell.sys/>.
- [41] 3GPP TS 25.224: "Physical Layer Procedures (TDD)".
- [42] 3GPP TS 44.318: "Generic access to the A/Gb interface; Mobile GA interface layer 3 specification".
- [43] 3GPP TS 43.129: "Packet-switched handover for GERAN A/Gb mode; Stage 2".
- [44] 3GPP TS 43.318: "Generic access to the A/Gb interface; Stage 2".
- [45] 3GPP TS 36.331: "Evolved Universal Terrestrial Radio Access (E-UTRA); Radio Resource Control (RRC); Protocol specification".
- [46] 3GPP TS 36.104: "Evolved Universal Terrestrial Radio Access (E-UTRA); Base Station (BS) radio transmission and reception".
- [47] 3GPP TS 36.211: "Evolved Universal Terrestrial Radio Access (E-UTRA); Physical Channels and Modulation".
- [48] 3GPP TS 23.041: "Technical realization of Cell Broadcast Service (CBS)".
- [49] 3GPP TS 23.122: "Non-Access-Stratum (NAS) functions related to Mobile Station (MS) in idle mode".
- [50] 3GPP TS 23.251: "Network sharing; Architecture and functional description".
- [51] 3GPP TS 24.008: "Mobile Radio Interface Layer 3 specification; Core Network Protocols - Stage 3".
- [52] 3GPP TS 24.368: "Non-Access Stratum (NAS) configuration Management Object (MO)".
- [53] 3GPP TS 31.102: "Characteristics of the USIM Application".

---

## 3 Definitions, abbreviations and symbols

### 3.1 Definitions

This document uses the following definitions:

**Additional PLMN:** when network sharing is in use within a given cell, an Additional PLMN refers to a PLMN of which the PLMN ID is broadcast in the SYSTEM INFORMATION TYPE 22 message (see 3GPP TS 44.018)

**A/Gb mode:** mode of operation of the MS when connected to the Core Network via GERAN and the A and/or Gb interfaces.

**Basic radio block period:** the time needed to transmit a radio block on one PDCH using a basic TTI configuration i.e. four TDMA frames.

**Block period:** block period is the sequence of four timeslots on a PDCH used to convey one radio block

**Broadcast/multicast receive mode:** In broadcast/multicast receive mode, the mobile station is receiving upper layer PDUs on packet data physical channels used for point-to-multipoint transmission (see sub-clause 5.3.1); it is not allocated any additional radio resource on packet data physical channels. Broadcast/multicast receive mode is a sub-state of packet idle mode. The mobile station listens to the PBCCH and PCCCH or, if those are not provided by the network, to the BCCH and CCCH.

**BTTI configuration:** a configuration in which a radio block is sent using one PDCH in each of four consecutive TDMA frames. In a BTTI configuration, one radio block can be transmitted in a basic radio block period.

**BTTI USF mode:** a mode in which the USF is received on one PDCH of a downlink PDCH-pair during four consecutive TDMA frames.



**Cell Change Notification (CCN):** See sub-clause 5.5.1.1a.

**Common PLMN:** when network sharing is in use within a given cell, the Common PLMN refers to the PLMN of which the PLMN ID is contained in the *Location Area Identification* IE broadcast in the SYSTEM INFORMATION TYPE 3 and SYSTEM INFORMATION TYPE 4 messages (see 3GPP TS 44.018, 3GPP TS 23.251 and 3GPP TS 24.008).

**Corresponding PDCH pair:** The Corresponding PDCH pair associated with an uplink PDCH pair which forms part of an uplink TBF assignment is the downlink PDCH pair which is monitored by the mobile station for the USF for the TBF and on which PACCH/D is transmitted. The Corresponding PDCH pair associated with a downlink PDCH pair which forms part of a downlink TBF assignment is the uplink PDCH pair on which PACCH/U is transmitted.

**CSG Cells Reporting:** refers to the ability of the mobile station to report measurements, CSG-ID and routing parameters of CSG cells in packet transfer mode. Routing parameters include Cell Identity and optionally the PLMN-ID and (for E-UTRAN cells only) the Tracking Area Code.

**Downlink Dual Carrier:** Downlink Dual Carrier is a feature allowing resources (for uplink and/or downlink TBFs and/or dedicated resources) to be assigned to a mobile station on up to two radio frequency channels within the same frequency band.

**Downlink Dual Carrier configuration:** A Downlink Dual Carrier configuration is one in which the mobile station has radio resources assigned over two radio frequency channels. In packet transfer mode, RLC/MAC blocks for uplink TBFs can only be transmitted on one radio frequency channel in any given radio block period, and RLC/MAC blocks for downlink TBFs can be transmitted on two radio frequency channels in any given radio block period. In dual transfer mode, uplink RLC/MAC blocks can be transmitted only on the radio frequency channel on which the dedicated resource is assigned.

**Downlink Multi Carrier (DLMC):** Downlink Multi Carrier is a feature allowing resources for a downlink TBF (and optionally an uplink TBF) to be assigned to a mobile station on two or more radio frequency channels in the same or different frequency bands using EGPRS or EGPRS2-A.

**DLMC configuration:** A DLMC configuration is one in which a mobile station in packet transfer mode has a downlink TBF where radio resources are configured on two or more radio frequency channels in the same or in different frequency bands. A mobile station in a DLMC configuration with an uplink TBF can only transmit RLC/MAC blocks for the uplink TBF on one radio frequency channel in any given radio block period whereas RLC/MAC blocks for the downlink TBF can be transmitted on one or more frequency channels in any given radio block period.

**DTM handover:** DTM handover is a feature used by the network to command a mobile station to move from its old (source) cell to a new (target) cell while operating in dual transfer mode and continue the operation of its ongoing circuit switched service and one or more of its ongoing packet switched services in the new cell. The mobile station is allocated one circuit switched radio resource and packet switched radio resources applicable to the new cell within a DTM HANDOVER COMMAND message.

**Dual transfer mode:** In dual transfer mode, the mobile station is allocated radio resources providing an RR connection (3GPP TS 44.018) and one or more Temporary Block Flows on one or more packet data physical channels. The allocation of radio resource for the RR connection and the Temporary Block Flow(s) is co-ordinated by the network in agreement with the capabilities of the mobile station in dual transfer mode.

**Dynamic Timeslot Reduction:** Dynamic Timeslot Reduction (DTR) is a feature used by the network to reduce the number of downlink timeslots monitored by the mobile station during inactivity periods of an EGPRS TBF. It is applicable when extended uplink TBF mode and/or delayed downlink TBF release are used.

**Early TBF establishment:** Procedure applicable when both the network and the mobile station support the extended uplink TBF mode, where the network keeps the uplink TBF open (by means of the extended uplink TBF mode operation) upon explicit request from the mobile station that pre-allocation is required. This allows the possibility to pre-allocate a TBF before actual data is ready for transmission.

**EGPRS:** Enhanced GPRS enables higher data rates through usage of 8PSK modulation in addition to GMSK. EGPRS also enables Incremental Redundancy operation.

**EGPRS TBF mode:** refers to a TBF utilising the EGPRS enhancements (e.g. Incremental Redundancy and possibly 8-PSK) or the EGPRS2 enhancements.

**EGPRS TBF:** refers to a TBF utilising the EGPRS enhancements, e.g. Incremental Redundancy and possibly 8-PSK.

**EGPRS2:** In the downlink direction, Enhanced GPRS Phase 2 enables higher data rates through usage of higher symbol rate, turbo codes, and QPSK, 16-QAM and 32-QAM modulations in addition to (or instead of) GMSK and 8PSK. In the uplink direction, Enhanced GPRS Phase 2 enables higher data rates through usage of higher symbol rate, and QPSK, 16-QAM and 32-QAM modulations in addition to (or instead of) GMSK and 8PSK. EGPRS2 consists of EGPRS2-A and EGPRS2-B in both directions.

**EGPRS2-A:** In the downlink direction, Enhanced GPRS Phase 2 Level A enables higher data rates through usage of turbo codes, and 16-QAM and 32-QAM modulations in addition to GMSK and 8-PSK. In the uplink direction, Enhanced GPRS Phase 2 Level A enables higher data rates through usage of 16-QAM modulation in addition to GMSK and 8-PSK.

**EGPRS2-B:** In the downlink direction, Enhanced GPRS Phase 2 Level B enables higher data rates through usage of higher symbol rate, turbo codes, and QPSK, 16-QAM and 32-QAM modulations in addition to GMSK or instead of 8PSK. In the uplink direction, Enhanced GPRS Phase 2 Level B enables higher data rates through usage of higher symbol rate, and QPSK, 16-QAM and 32-QAM modulations in addition to GMSK or instead of 8PSK.

**EGPRS2 TBF:** refers to a TBF utilising the EGPRS2 enhancements in the direction of data transfer, downlink or uplink. More specifically, in each direction, downlink or uplink, an EGPRS2-A TBF refers to a TBF utilising the EGPRS2-A enhancements and an EGPRS2-B TBF refers to a TBF utilising the EGPRS2-B enhancements. An EGPRS2 TBF operates in EGPRS TBF mode.

**EGPRS-GMSK only TBF:** refers to a TBF in EGPRS TBF mode but making only use of MCS-1 to MCS-4 modulation and coding schemes. The number of PDCHs assigned to an EGPRS-GMSK only TBF can be extended to the maximum number of timeslots compatible with the GPRS multislot class of the MS. This mode is determined by the mobile station based on the aggregate timeslot allocation assigned by the network. In the case the aggregate timeslot allocation is not within the indicated EGPRS multislot class, but is within the indicated GPRS multislot class, a mobile station supporting this mode shall consider the TBF to be in EGPRS-GMSK only mode (see sub-clause 9.1.9.2). This mode is only applicable in packet transfer mode.

**Enhanced Flexible Timeslot Assignment (EFTA):** Enhanced Flexible Timeslot Assignment gives the network the possibility to allocate one and the same mobile station uplink and downlink PDCH resources that overlap in time. This mobile station shall then for these overlapping instances prioritize uplink radio block transmission over attempting to read downlink radio blocks (unless performing pre-emptive retransmissions), but shall always attempt to read downlink radio blocks if it has nothing to transmit. If it does not need to use all its allocated uplink PDCH resources, the mobile station shall transmit its uplink radio blocks in such a way that the number of downlink radio blocks it can read is maximized. Both network and mobile station must support extended uplink TBF mode in order for Enhanced Flexible Timeslot Assignment, EFTA, to be supported.

**Enhanced Multiplexing for Single RLC Entity (EMSR):** Refers to the multiplexing of upper layer data flows associated with multiple PFCs with at least two of them having unique TFIs within the context of a single RLC entity for single TBF operation. EMSR may only be used on a TBF operating in EGPRS TBF mode. EMSR is not applicable to Multiple TBF operation or when Exclusive Allocation is used.

**Enhanced Multiplexing for Single TBF (EMST):** refers to the multiplexing of upper layer data flows using one or more RLC entities on a single TBF where each RLC entity operates in a different RLC mode. EMST is applicable only to TBFs in EGPRS TBF mode. EMST is not applicable to Multiple TBF operation.

**Extended uplink TBF mode:** In the *extended uplink TBF mode*, the uplink TBF may be maintained during temporary inactive periods, where the mobile station has no RLC information to send. The network determines the release of the uplink TBF (see sub-clause 9.3.1b).

**Fast Ack/Nack Reporting (FANR):** Fast Ack/Nack Reporting enables the use of a PAN field within an RLC/MAC block for EGPRS data transfer or for EGPRS2 data transfer. FANR enables the mobile station to transmit in the uplink direction a PAN field corresponding to a downlink TBF. Similarly FANR enables the network to transmit in the downlink direction a PAN field corresponding to an uplink TBF.

**Flexible Timeslot Assignment (FTA):** Flexible Timeslot Assignment allows increased flexibility in the assignment of PDCH resources by letting some of the limitations imposed by the mobile stations multislot class (see 3GPP 45.002) to be respected on an allocation basis (i.e. per radio block period) rather than on an assignment basis (i.e. at TBF setup time).

**GAN Cell:** A cell under control of a GANC.

**GAN Mode:** MS mode of operation where the MS is connected to the Core Network via a GANC and the A and/or Gb interfaces.

**GPRS multislot class / EGPRS multislot class:** refers to the different mobile station capabilities to transmit and receive on different combinations of multiple PDCHs. The multislot classes are defined in 3GPP TS 45.002. Note that the mobile station may indicate different multislot classes for circuit mode services for GPRS and for EGPRS (see 3GPP TS 24.008). Different multislot class mobile stations are capable of supporting different medium access modes (see sub-clause 5.2.4).

**GPRS TBF mode:** refers to a TBF not utilising EGPRS or EGPRS2.

**Inter-band reception:** see 3GPP TS 45.005.

**IR:** Incremental redundancy, enables higher data rates through combining information from different transmissions of RLC data blocks when decoding. Also known as Hybrid Type II/III ARQ.

**Iu mode:** mode of operation of the MS when connected to the Core Network via GERAN or UTRAN and the Iu interface.

**MAC-dedicated state:** a MAC-control-entity state where a DBPSCH is assigned and no SBPSCH is assigned. This state only applies in *Iu mode*.

**MAC-DTM state:** a MAC-control-entity state where at least one DBPSCH and one SBPSCH are assigned. This state only applies in *Iu mode*.

**MAC-idle state:** a MAC-control-entity state where no basic physical subchannels are assigned. This state only applies in *Iu mode*.

**MAC-shared state:** a MAC-control-entity state where at least one SBPSCH is assigned. This state only applies in *Iu mode*.

**MCS:** Modulation and Coding Scheme.

**MS multislot class:** refers to GPRS multislot class in case of a GPRS TBF mode or EGPRS-GMSK only TBF mode. In case of EGPRS TBF mode, MS multislot class refers to EGPRS multislot class.

**Multiple TBF procedures:** A mobile station that supports multiple TBF procedures can support one or more concurrent TBFs in either direction while in packet transfer mode (A/Gb mode). A network that supports multiple TBF procedures can support one or more concurrent TBFs in either direction for a mobile station that supports multiple TBF procedures in packet transfer mode (A/Gb mode).

**Multiple TTI (MTTI) configuration:** A mobile station that supports MTTI Configurations may be assigned a TBF using both RTTI resources (PDCH-pairs) and BTTI resources (PDCHs).

**Network sharing:** network sharing is an optional feature that allows different core network operators to connect to the same shared radio access network (see 3GPP TS 23.251). When network sharing is in use within a given cell, the network broadcasts within system information the PLMN identities of the PLMNs sharing the cell. A mobile station supporting network sharing uses this information for its PLMN (re)selection processes and indicates the selected PLMN to the BSS.

**Non-contiguous intra-band reception:** see 3GPP TS 45.005.

**Non-extended uplink TBF mode:** Where a distinction is needed, an uplink TBF, not operating in the extended uplink TBF mode, is referred as operating in the *non-extended uplink TBF mode*.

**Non-synchronized PS handover:** The basic type of PS handover which is used when the time bases of the involved cells bear no particular relationship between themselves and when the MS cannot predict the timing advance to be used in the target cell before access in this cell. The requirements that apply for the non-synchronized PS handover are given in 3GPP TS 45.010.

**Packet access failure:** Packet access failure refers to the access cases where the mobile station is explicitly denied access to the network, i.e. is not allowed to transmit (EGPRS) PACKET CHANNEL REQUEST or MPRACH PACKET CHANNEL REQUEST messages or receives a PACKET QUEUING NOTIFICATION message or a PACKET ACCESS REJECT message.

**Packet flow context:** Packet Flow Context (PFC) procedures are described in 3GPP TS 23.060. A Packet Flow Identifier (PFI) is used to identify a PFC.

**Packet idle mode:** In packet idle mode, the mobile station is prepared to transfer LLC PDUs on packet data physical channels (see sub-clause 5.3). The mobile station is not allocated any radio resource on a packet data physical channel; it listens to the PBCCH and PCCCH or, if those are not provided by the network, to the BCCH and the CCCH.

**Packet transfer mode:** In packet transfer mode, the mobile station is prepared to transfer LLC PDUs on packet data physical channels (see sub-clause 5.4). The mobile station is allocated radio resource on one or more packet data physical channels for the transfer of LLC PDUs.

**Piggy-backed Ack/Nack (PAN) field:** A Piggy-backed Ack/Nack field provides acknowledgement status of downlink (respectively uplink) RLC data blocks within an uplink (respectively downlink) RLC/MAC block for data transfer.

**Pre-synchronized PS handover:** A type of PS handover where the MS uses the timing advance included in the PS HANDOVER COMMAND message for immediate use in the target cell. The requirements that apply for the pre-synchronized PS handover are given in 3GPP TS 45.010.

**PS handover:** PS handover is a feature used by the network to command a mobile station to move from its old (source) cell to a new (target) cell while operating in packet transfer mode and continue the operation of one or more of its ongoing packet switched services in the new cell using TBF resource allocations provided within a PS HANDOVER COMMAND message. For PS handover to a GAN cell the mobile station receives the assignment of the target cell radio resources prior to receiving the PS HANDOVER COMMAND message.

**Radio block:** A radio block is the sequence of four normal bursts carrying one RLC/MAC protocol data units (see 3GPP TS 44.004). (The one exception is a radio block occasionally used on PACCH consisting of a sequence of four access bursts, each carrying a repetition of one short RLC/MAC block.). A radio block is sent either on a PDCH (BTTI configuration) or a PDCH-pair (RTTI configuration).

**Random access failure:** Random access failure refers to the access case when the mobile station does not get any response from the network to its (EGPRS) PACKET CHANNEL REQUEST or MPRACH PACKET CHANNEL REQUEST messages.

**Random values:** In a number of places in this Technical Specification, it is mentioned that some value must take a "random" value, in a given range, or more generally with some statistical distribution. For such random values refer to 3GPP TS 44.018.

**Reduced Latency:** refers to the use of FANR either in BTTI configuration or in RTTI configuration. Reduced Latency capability is required for the use of MTTI configurations.

**Reduced radio block period:** the time needed to transmit a radio block on a PDCH-pair using a reduced TTI configuration i.e. two TDMA frames.

**RLC/MAC block:** A RLC/MAC block is the protocol data unit exchanged between RLC/MAC entities (see clause 10 and 3GPP TS 44.004).

**RLC/MAC control block:** A RLC/MAC control block is the part of an RLC/MAC block carrying a control message between RLC/MAC entities (see sub-clause 10.3).

**RLC data block:** A RLC data block is the part of a RLC/MAC block carrying user data or signalling data received from an upper layer (see sub-clause 10.2).

**RLC Non-Persistent Mode:** A mode of RLC operation where retransmissions are possible but it is not required that all RLC data blocks are correctly received at the receiving RLC endpoint.

**RR connection:** An RR connection is a physical connection established between a mobile station and the network to support the upper layers' exchange of information flows. An RR connection is maintained and released by the two peer entities.

**RRC connection:** An RRC connection is a point-to-point, bi-directional, logical connection between RRC peer entities in the mobile station and the GERAN characterised by the allocation of a G-RNTI. A mobile station has either zero or one RRC connections. RRC connections only apply in *lu mode*.

**RTTI configuration:** a configuration in which a radio block is sent using two PDCHs (PDCH-pair) in either the first two or the last two TDMA frames of any given basic radio block period.

**RTTI USF mode:** a mode in which the USF is received on a downlink PDCH-pair during two consecutive TDMA frames.

**Source BSS:** Within the context of a PS handover the source BSS is the BSS controlling the cell in which the mobile station is camping prior to performing PS handover (i.e. it controls the old cell).

**Synchronized PS handover:** A type of PS handover which is possible when the time bases of the involved cells are synchronized, and for which no timing advance needs to be provided to the MS. The requirements that apply for the synchronized PS handover are given in 3GPP TS 45.010.

**Target BSS:** Within the context of a PS handover the target BSS is the BSS controlling the cell in which the mobile station is camping after successful completion of PS handover (i.e. it controls the new cell). If the same BSS controls both the old cell and the new cell associated with the PS handover of any given mobile station then the source BSS and the target BSS are the same.

**TBF abort:** The term "abort" as applied to TBF is used when the TBF is abruptly stopped without using the Release of TBF procedures defined in clause 9.

**TBF release:** The term "release" as applied to TBF is used when the TBF is stopped using one of the Release of TBF procedures defined in clause 9.

**Temporary Block Flow (TBF):** A Temporary Block Flow is, in *A/Gb mode*, a physical connection used by the two RR peer entities to support the unidirectional transfer of LLC PDUs on packet data physical channels (see sub-clause 5.2.1). In *Iu mode*, a TBF is a logical connection offered by two MAC entities to support the unidirectional transfer of RLC PDUs on basic physical subchannels.

**Timer Expiry:** A started timer has run the time specified.

**Timer Restart:** A timer that may already be running is stopped and then started again to run the time specified.

**Timer Start:** A timer is started to run the time specified.

**Timer Stop:** A started timer is stopped and its value is then undefined.

**Unique Frequency Parameter Set (UFPS):** see 3GPP TS 45.008

**Uplink control timeslot:** refers to the timeslot number of the timeslot where the PACCH/U for the MS is located in case of a BTTI configuration, or to the uplink PDCH pair where the PACCH/U for the MS is located in case of an RTTI configuration. This parameter is set to the value of the Uplink Control timeslot IE in an assignment message. Otherwise, this parameter is unassigned. In *A/Gb mode*, this parameter is applicable only to multiple TBF procedures.

**Uplink State Flag (USF):** The Uplink State Flag (USF) is used on PDCH channel(s) to allow multiplexing of uplink Radio blocks from different TBFs belonging to the same or different mobile stations (see sub-clause 5.2.3, clause 10 and 3GPP TS 45.002).

**Upper-layer PDU:** An upper-layer PDU is, in *A/Gb mode*, an LLC PDU and, in *Iu mode*, an RRC message, a PDCP PDU or a PDU from the NAS user plane.

## 3.2 Abbreviations

This document uses abbreviations from 3GPP TR 21.905 and 3GPP TS 43.064. It also uses the following abbreviations:

ARI	Access Request Identifier
ARQ	Automatic Repeat reQuest
AS	Access Stratum
BCCH	Broadcast Control CHannel
BSS	Base Station Subsystem
BTTI	Basic Transmission Time Interval
CBCH	Cell Broadcast CHannel
CC	Call Control
CCCCH	COMPACT CCCH
CCCH	Common Control CHannel
CCN	Cell Change Notification
CN	Core Network

CPBCCH	COMPACT PBCCH
CS- <i>i</i>	GPRS Coding Scheme <i>i</i>
DAS- <i>i</i>	EGPRS2 Downlink level A modulation and coding Scheme <i>i</i>
DBS- <i>i</i>	EGPRS2 Downlink level B modulation and coding Scheme <i>i</i>
DC	Dedicated Control
DLC	Data Link Control
DLMC	Downlink Multi Carrier
DBPSCH	Dedicated Basic Physical Sub CHannel
DTR	Dynamic Timeslot Reduction
ECSD	Enhanced Circuit Switched Data
EDGE	Enhanced Data rates for Global Evolution
E-FACCH	Enhanced FACCH
EGPRS	Enhanced General Packet Radio Service
EGPRS2	EGPRS Phase 2
eNB	E-UTRAN NodeB
E-TCH	Enhanced TCH
eTFI	extended Temporary Flow Identifier
EUTRA	Evolved UTRA
E-UTRAN	Evolved UTRAN
FACCH	Fast Associated Control CHannel
FANR	Fast Ack/Nack Reporting
GAN	Generic Access Network
GANC	Generic Access Network Controller
GC	General Control
GERAN	GSM/EDGE Radio Access Network
GPRS	General Packet Radio Service
GRA	GERAN Registration Area
G-RNTI	GERAN Radio Network Temporary Identity
GSM	Global System for Mobile communications
IETF	Internet Engineering Task Force
IMSI	International Mobile Subscriber Identity
IP	Internet Protocol
LCS	LoCation Services
LLC	Logical Link Control
MAC	Medium Access Control
MCS- <i>i</i>	EGPRS Modulation and Coding Scheme <i>i</i>
MM	Mobility Management
MME	Mobility Management Entity
MPRACH	MBMS Packet Random Access Channel
MS	Mobile Station
NAS	Non Access Stratum
NSAPI	Network-layer SAPI
Nt	Notification
O-FACCH	Octal FACCH
O-TCH	Octal TCH
PAN	Piggy-backed Ack/Nack
PBCCH	Packet BCCH
PDCH	Packet Data CHannel
PDCP	Packet Data Convergence Protocol
PDP	Packet Data Protocol
PDTCH	Packet Data TCH
PDU	Protocol Data Unit
PFC	Packet Flow Context
PFI	Packet Flow Identifier
PLMN	Public Land Mobile Network
PTCCH	Packet Timing-advance Control CHannel
p-t-m	point-to-multipoint
P-TMSI	Packet TMSI
QoS	Quality of Service
RAB	Radio Access Bearer
RANAP	Radio Access Network Application Part
RB	Radio Bearer

RLC	Radio Link Control
RNC	Radio Network Controller
RNS	Radio Network Subsystem
RNSAP	Radio Network Subsystem Application Part
ROHC	Robust Header Compression
RR	Radio Resource
RRC	Radio Resource Control
RTP	Real Time Protocol
RTTI	Reduced Transmission Time Interval
SACCH	Slow Associated Control CHannel
SAP	Service Access Point
SAPI	Service Access Point Identifier
SDCCH	Stand-alone Dedicated Control CHannel
SDU	Service Data Unit
SBPSCH	Shared Basic Physical Sub CHannel
TBF	Temporary Block Flow
TCH	Traffic Channel
TCP	Transmission Control Protocol
TFI	Temporary Flow Identifier
TLLI	Temporary Logical Link Identifier
TMSI	Temporary Mobile Subscriber Identity
TSC	Training Sequence Code
TTI	Transmission Time Interval
UAS- <i>i</i>	EGPRS2 Uplink level A modulation and coding Scheme <i>i</i>
UBS- <i>i</i>	EGPRS2 Uplink level B modulation and coding Scheme <i>i</i>
UDP	User Datagram Protocol
UMTS	Universal Mobile Telecommunication System
USF	Uplink State Flag
UTRAN	UMTS Terrestrial Radio Access Network

### 3.3 Symbols

This document uses the following symbols:

<i>A</i>	Interface between a BSS and a 2G MSC
<i>Gb</i>	Interface between a BSS and a 2G SGSN
<i>Iu</i>	Interface between a BSS or an RNC and a 3G MSC or a 3G SGSN
<i>Iu-cs</i>	Interface between a BSS or an RNC and a 3G MSC
<i>Iu-ps</i>	Interface between a BSS or an RNC and a 3G SGSN
<i>Iur-g</i>	Interface between two BSSs or between a BSS and an RNC
<i>Um</i>	Interface between an MS and the GERAN

---

## 4 Layered overview of radio interface

The Radio Resource sublayer provides the functions necessary for:

- Radio Resource (RR) management of packet data physical channels (PDCHs); and
- Radio Link Control and Medium Access Control (RLC/MAC) on packet data physical channels.

As shown in figure 4.1, the RR sublayer provides services to the MM and LLC sublayers. The RR sublayer utilises the services of the Data Link layer (signalling layer 2) and the Physical Link layer. The packet logical channels PBCCH, PCCCH (including PPCH, PAGCH and PRACH), PACCH and PDTCH, are multiplexed onto the packet data physical channels on a per radio block basis.

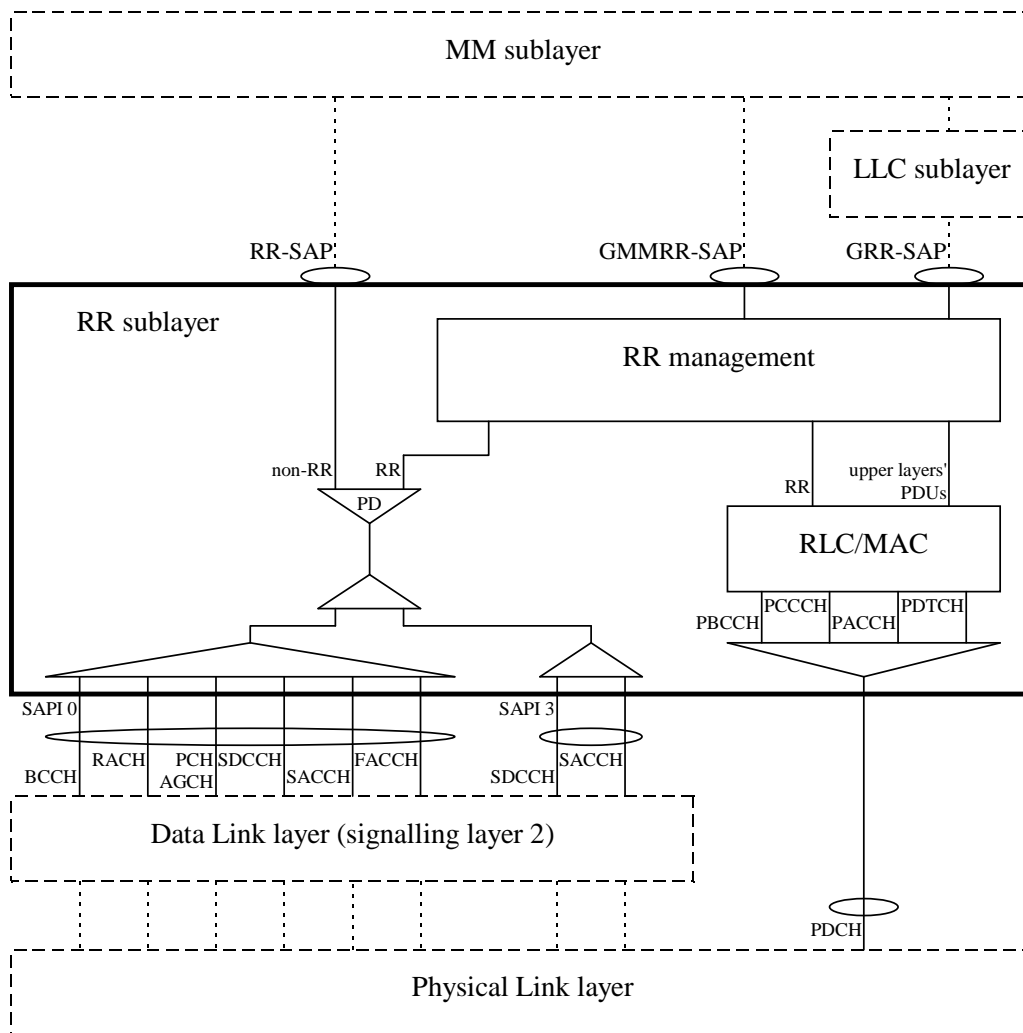

Figure 4.1: Protocol architecture of Radio Resource (RR) sublayer and RLC/MAC function

## 4.1 Layer services

The RR sublayer provides services for the transfer of upper layer PDUs using a shared medium between multiple mobile stations and the network. Direct communication is only possible between the network and one or more mobile stations. The RLC/MAC function supports three modes of operation:

- unacknowledged operation;
- acknowledged operation; and
- non-persistent operation.

The RR sublayer further provides services for the paging of mobile stations.

## 4.2 Layer functions

The RLC function defines the procedures for segmentation and reassembly of LLC PDUs into RLC/MAC blocks and, in RLC acknowledged mode of operation, for the Backward Error Correction (BEC) procedures enabling the selective retransmission of unsuccessfully delivered RLC/MAC blocks. In RLC acknowledged mode of operation, the RLC function preserves the order of higher layer PDUs provided to it.

The RLC function provides also link adaptation.

In EGPRS in RLC acknowledged mode of operation, the RLC function may provide Incremental Redundancy (IR).



The MAC function defines the procedures that enable multiple mobile stations to share a common transmission medium, which may consist of several physical channels. The function may allow a mobile station to use several physical channels in parallel, i.e. use several timeslots within the TDMA frame.

For the mobile station originating access, the MAC function provides the procedures, including the contention resolution procedures, for the arbitration between multiple mobile stations simultaneously attempting to access the shared transmission medium.

For the mobile station terminating access, the MAC function provides the procedures for queuing and scheduling of access attempts.

When the PS handover procedure is supported the RLC and MAC functions provide the procedures for directing a mobile station to a new cell and continuing packet switched services without the use of contention resolution procedures (i.e. RACH/PRACH) in the new cell.

When the DTM handover procedure is supported the procedures for directing a mobile station to a new cell and continuing both circuit switched and packet switched services are provided by the RLC and MAC functions, under the control of the RR function (see 3GPP TS 44.018).

## 4.3 Service primitives

Information flow between layers is performed by the use of Service Primitives. Service Access Points (SAP) and their corresponding Service Primitives for the RR sublayer are defined in 3GPP TS 24.007.

## 4.4 Services required from lower layers

The RLC/MAC function uses the services provided by the physical link layer as defined in 3GPP TS 44.004.

The RR sublayer may use the services provided by the data link layer as defined in 3GPP TS 44.005. Moreover, the RR sublayer directly uses services provided by the physical layer such as BCCH searching, as defined in 3GPP TS 44.004.

---

# 5 Introduction to the Medium Access Control (MAC) procedures

## 5.1 General

The Medium Access Control procedures include the functions related to the management of the shared transmission resources, e.g. the packet data physical channels and the radio link connections on packet data physical channels.

The Medium Access Control procedures support the provision of Temporary Block Flows (TBFs) that allow the point-to-point transfer of signalling and user data within a cell between the network and a mobile station. The MAC procedures also support the provision of MBMS radio bearers that allow the point-to-multipoint transfer of signalling and user data within a cell between the network and one (or more) mobile station(s).

Moreover, the Medium Access Control procedures include the procedures for reception of PBCCH and PCCCH, which permits autonomous cell reselection performed by the mobile station (see 3GPP TS 45.008).

## 5.2 Multiplexing principles

### 5.2.1 Temporary Block Flow

A Temporary Block Flow (TBF) is a physical connection used by the two RR entities to support the unidirectional transfer of upper layer PDUs on packet data physical channels.

The TBF is allocated radio resources on one or more assigned PDCHs and comprises a number of RLC/MAC blocks carrying one or more upper layer PDUs. If Downlink Dual Carrier is supported by both the mobile station and the

network, the assigned PDCHs for a given TBF may be on one or two radio frequency channels. . If Downlink Multi Carrier is supported by both the mobile station and the network and a DLMC configuration is used, the assigned PDCHs for the downlink TBF shall be on two or more radio frequency channels and the assigned PDCHs for the uplink TBF (if assigned) may be on one or more radio frequency channels. The maximum number of radio frequency channels the PDCHs can be assigned on is indicated by the maximum number of downlink carriers a DLMC capable MS supports, see 3GPP TS 24.008. A TBF is temporary and is maintained only for the duration of the data transfer (i.e. until there are no more RLC/MAC blocks to be transmitted and, in RLC acknowledged mode, all of the transmitted RLC/MAC blocks have been successfully acknowledged by the receiving entity).

A TBF may operate in either GPRS TBF mode or EGPRS TBF mode. For Downlink Dual Carrier and DLMC configurations TBFs shall operate in EGPRS TBF mode. A TBF assigned in IMMEDIATE PACKET ASSIGNMENT message shall operate in EGPRS TBF mode. The network sets the TBF mode in the PACKET UPLINK ASSIGNMENT, MULTIPLE TBF UPLINK ASSIGNMENT, PACKET DOWNLINK ASSIGNMENT, MULTIPLE TBF DOWNLINK ASSIGNMENT, PACKET TIMESLOT RECONFIGURE, MULTIPLE TBF TIMESLOT RECONFIGURE, IMMEDIATE ASSIGNMENT or PACKET CS RELEASE INDICATION message. The EGPRS TBF mode is only supported by EGPRS capable MSs.

If a mobile station is assigned concurrent TBFs, these shall be in the same TBF mode.

A TBF in EGPRS mode operates using one of four groups of modulation and coding schemes:

- EGPRS-GMSK only (applicable to uplink TBFs only): this comprises MCS-1 to MCS-4
- EGPRS: this comprises MCS-1 to MCS-9
- EGPRS2-A: for uplink TBFs, this comprises MCS-1 to MCS-6 and UAS-7 to UAS-11; for downlink TBFs, this comprises MCS-1 to MCS-4, MCS-6 (only for retransmissions of blocks originally transmitted using EGPRS), MCS-7, MCS-8 and DAS-5 to DAS-12
- EGPRS2-B: for uplink TBFs, this comprises MCS-1 to MCS-4 and UBS-5 to UBS-12; for downlink TBFs, this comprises MCS-1 to MCS-4, MCS-6 to MCS-9, DAS-5, DAS-6, DAS-8, DAS-9, DAS-11 and DBS-5 to DBS-12.

The group of modulation and coding schemes to be used on a PDCH associated with a TBF is indicated in the assignment message. The EGPRS-GMSK only group applies if the aggregate timeslot allocation is not within the indicated EGPRS multislot class, but is within the indicated GPRS multislot class.

The use of the EGPRS2-A group for uplink or downlink is only supported by MSs which are capable of EGPRS2-A or EGPRS2-B in that direction. The EGPRS2-B group is only supported by MSs which are capable of EGPRS2-B in that direction. If a mobile station supports EGPRS2, the same group of modulation and coding schemes shall be used for all TBFs in a given direction.

If a mobile station indicates support of Reduced Latency (see 3GPP TS 24.008), it may be assigned TBFs with FANR activated (see sub-clause 9.1.14), either in BTTI configuration, RTTI configuration or (if the mobile additionally supports MTTI configurations) MTTI configuration. If a mobile station indicates support of FANR (see 3GPP TS 24.008), it may be assigned TBFs with FANR activated (see sub-clause 9.1.14) in BTTI configuration only. The network shall ensure that, if a mobile station is assigned a TBF with FANR activated, FANR shall be activated for all concurrent TBFs assigned to that mobile station.

For the case where a mobile station supports multiple TBF procedures the maximum number of TBFs it can support concurrently is not specified. Mobile station implementations are expected to ensure that the mobile station can support a sufficient number of TBFs to operate all the PDP contexts it has activated. As such, a mobile station may choose to release, modify or activate one or more PDP contexts when prioritizing the services it wants to operate concurrently. The network is not required to consider any potential complexity limitations regarding the number of concurrent TBFs when establishing an uplink or downlink TBF for a mobile station that supports multiple TBF procedures.

The following messages are used only if both the mobile station and the network support multiple TBF procedures:

- MULTIPLE TBF UPLINK ASSIGNMENT
- MULTIPLE TBF DOWNLINK ASSIGNMENT
- MULTIPLE TBF TIMESLOT RECONFIGURE.

## 5.2.2 Temporary Flow Identity

Each TBF is assigned a Temporary Flow Identity (TFI) by the network. The mobile station shall assume that the TFI value is unique among concurrent TBFs in the same direction (uplink or downlink) on all PDCHs used for the TBF. In (E)GPRS, the same TFI value may be used concurrently for TBFs on other PDCHs in the same direction and for TBFs in the opposite direction. For a TBF with FANR activated, the TFI value shall be unique among concurrent TBFs assigned to one mobile station in the same direction (uplink or downlink). If Enhanced Multiplexing for Single TBF (EMST) is used, the network shall assign, according to the rules above, a unique TFI value to each RLC entity multiplexed on the TBF. If Enhanced Multiplexing for Single RLC Entity (EMSR) is supported by a mobile station the network may allocate multiple PFCs on a common RLC entity where at least two of these PFCs are allocated a unique TFI value (see sub-clause 5.12). The downlink TBF of a mobile station in a DLMC configuration may be assigned an eTFI if the maximum number of downlink timeslots the mobile supports is greater than 20. The eTFI supplements the TFI so that combined they uniquely identify the downlink TBF on all of the PDCH resources allocated for that TBF on a given downlink carrier. The TBF may be assigned different eTFI – TFI combinations for each downlink carrier used in a given DLMC configuration. If a mobile station receives an RLC/MAC control block which includes a downlink TFI equal to a TFI supported by a downlink TBF assigned to the mobile station, which is received on a timeslot or PDCH-pair which is not a timeslot or PDCH-pair which is assigned to the mobile station as part of that TBF, the mobile station shall consider that message as not addressed to it. If a mobile station receives an RLC/MAC control block which includes an uplink TFI equal to a TFI supported by an uplink TBF assigned to the mobile station, which is received on a timeslot or PDCH-pair which does not correspond to a timeslot or PDCH-pair which is assigned to the mobile station as part of that TBF, the mobile station shall consider that message as not addressed to it.

NOTE: The behaviour of the mobile station in case it receives a control block not addressed to it is specified in sub-clause 10.4.10

An RLC/MAC block associated with a certain TBF shall comprise a TFI. The TBF is identified by the TFI together with, in case of a RLC data block, the direction (uplink or downlink) in which the RLC data block is sent; and in case of a RLC/MAC control message, the direction in which the RLC/MAC control message is sent and the message type. In the case of a DLMC configuration where a downlink TBF is assigned an eTFI on a specific downlink carrier, an RLC/MAC block associated with that TBF on that downlink carrier shall comprise a TFI and an eTFI (see sub-clause 10.0a.2).

Global\_TFI is used to unambiguously identify the mobile station in packet transfer mode, MAC-Shared state, dual transfer mode or MAC-DTM state within an uplink or downlink RLC/MAC control message. In the case of a DLMC configuration and a mobile station supporting eTFI, Global\_TFI and eTFI may be used to unambiguously identify the mobile station in packet transfer mode within a downlink RLC/MAC control message. If present, the Global TFI addresses the MS using either:

- an uplink TFI identifying an uplink TBF assigned to the MS such that the timeslot or PDCH-pair on which the Global TFI is sent corresponds to a timeslot or PDCH-pair assigned to that TBF, or
- a downlink TFI identifying a downlink TBF assigned to the MS such that the timeslot or PDCH-pair on which the Global TFI is sent is a timeslot or PDCH-pair assigned to that TBF.

If there is a choice of TFI to use, which TFI is used is at the discretion of the sender except where explicitly defined by procedure. For the mobile station in broadcast/multicast receive mode, the Global TFI includes the MBMS Bearer Identity of the MBMS radio bearer the RLC/MAC control message relates to (in the most significant bit(s) of the DOWNLINK\_TFI field) and, where explicitly defined by procedure, the current MS\_ID of the mobile station the message relates to (in the remaining least significant bit(s) of the DOWNLINK\_TFI field).

## 5.2.3 Uplink State Flag

An Uplink State Flag (USF) is included in the header of each RLC/MAC block on a downlink PDCH, as specified in clause 10. It may be used by the network to control the multiplexing of different mobile stations and TBFs on an uplink PDCH. The use of USF is further specified in 3GPP TS 45.002.

## 5.2.4 Medium Access modes

Three medium access modes are supported:

- Dynamic Allocation, characterised by that the mobile station detecting an assigned USF value for each assigned uplink PDCH when operating in BTTI configuration or each assigned uplink PDCH-pair when operating in

RTTI configuration-and block or group of four blocks that it is allowed to transmit on that PDCH/PDCH-pair (see sub-clause 8.1.1.1);

- Extended Dynamic Allocation is characterised by the mobile station detecting an assigned USF value for any assigned uplink PDCH when operating in BTTI configuration or any assigned uplink PDCH-pair when operating in RTTI configuration, allowing the mobile station to transmit on that PDCH/PDCH-pair and all higher numbered assigned PDCHs/PDCH-pairs in the same block or group of four blocks (see sub-clause 8.1.1.2);
- Exclusive Allocation, characterised by the mobile station being granted the exclusive right to transmit on the assigned PDCH/H for the duration of an uplink TBF (see sub-clause 8.1.1.3a). Exclusive allocation is applicable only in dual transfer mode. When using exclusive allocation, only one TBF shall be established in the uplink.

Dynamic Allocation medium access mode shall be supported by all networks that support GPRS. The support of Extended Dynamic Allocation is optional for the network.

Dynamic Allocation shall be supported in all mobile stations. The support of Extended Dynamic Allocation is mandatory for mobile stations of multislot classes 22, 24, 25 and 27, for multislot class type 1 mobile stations that can transmit on three or more timeslots (either PDCH or TCH), and for mobile stations supporting Flexible Timeslot Assignment (see 3GPP TS 24.008). The support of Extended Dynamic Allocation for other mobile stations is optional and shall be indicated in the MS Radio Access Capability.

NOTE: Flexible Timeslot Assignment is applicable only when Extended Dynamic Allocation is used, or as explicitly indicated for certain RTTI configurations in 3GPP TS 45.002.

The exclusive allocation shall be used in dual transfer mode during uplink operation with a half-rate PDCH.

The network shall ensure that the medium access mode and the resource allocation used for a mobile station are compatible with the permitted multislot configurations (see 3GPP TS 45.002).

## 5.2.4a Multiplexing of GPRS, EGPRS and EGPRS2 capable mobile stations

GPRS, EGPRS and EGPRS2 capable mobile stations can be multiplexed dynamically on the same PDCH.

If dynamic or extended dynamic allocation is used, a mobile station shall be able to decode the USF that allocates the uplink to that mobile station as follows,

- For a mobile station supporting only GPRS the network shall use GMSK modulation, i.e. either CS-1 to CS-4 or MCS-0, MCS-1 to MCS-4, in those blocks. The other blocks may use other modulations.
- For a mobile station supporting EGPRS, the network may use either GMSK modulation or 8-PSK modulation, i.e. CS-1 to CS-4, MCS-0, MCS-1 to MCS-4, MCS-5 to MCS-9 or DAS-5 to DAS-7 in those blocks.
- For a mobile station supporting EGPRS2-A in the downlink, the network may use either GMSK, 8-PSK, 16-QAM or 32-QAM modulation with normal symbol rate, i.e. CS-1 to CS-4, MCS-0, MCS-1 to MCS-9 or DAS-5 to DAS-12 in those blocks.
- For a mobile station supporting EGPRS2-B in the downlink, the network may use GMSK, 8-PSK, 16-QAM and 32-QAM modulations with normal symbol rate, or QPSK, 16-QAM or 32-QAM modulations with higher symbol rate in those blocks, i.e. CS-1 to CS-4, MCS-0, MCS-1 to MCS-9, DAS-5 to DAS-12 or DBS-5 to DBS-12.
- For a mobile station supporting eTFI, the network may use CS-1 for RLC/MAC control blocks irrespective of whether or not the RLC/MAC control blocks are associated with a TBF assigned an eTFI (see sub-clause 5.2.2, 8.1.1.1.1 and 8.1.1.2.2).

One exception to the list above is for mobile stations not supporting eTFI where the network shall not use RLC/MAC control blocks associated with a TBF assigned an eTFI.

A mobile station assigned an uplink TBF using FANR shall be able to decode the PAN in a downlink block. If the PAN is addressed to a mobile station other than the one to which the data in the RLC/MAC block is addressed, then the network may use in this block any of the modulation and coding schemes allowed for USF transmission to that mobile station. One exception applies for a mobile station not supporting eTFI in which case the network shall not address the PAN to that mobile station if the RLC/MAC block is associated with a TBF assigned an eTFI (see sub-clause 8.1.2.1)

unless the assigned eTFI field equals "000". For a mobile station supporting eTFI (see sub-clause 5.2.2) the network may address the PAN to that mobile station irrespective of whether or not the RLC/MAC block is associated with a TBF assigned an eTFI.

NOTE 1: The stealing bits in the EGPRS GMSK blocks are set to indicate CS-4. The coding and interleaving of the USF is done as defined for CS-4. That leads to:

- 1) A GPRS mobile station is able to detect the USF in EGPRS GMSK blocks. The risk that the rest of the block will be misinterpreted as valid information is low;
- 2) An EGPRS mobile station cannot differentiate CS-4 blocks from EGPRS GMSK blocks by decoding the stealing bits only. However, an EGPRS mobile station in EGPRS TBF mode needs only to decode GMSK blocks assuming either of MCS-1 to MCS-4, in order to determine if they were aimed for it.

NOTE 2: Due to mobile station synchronisation reasons, special requirements apply for the scheduling, the modulation and coding scheme and the output power of blocks that are transmitted to a mobile station with an active uplink or downlink TBF, see 3GPP TS 45.008.

A mobile station shall only attempt to decode USF or PAN in a downlink radio block transmitted using a TSC it has been assigned. A mobile station that supports the extended TSC sets (see 3GPP TS 45.002 [32]) can have up to two TSCs assigned for a given PDCH and shall attempt to decode USF or PAN in a downlink radio block it receives on that PDCH using its assigned TSC(s).

## 5.3 Packet idle mode

In packet idle mode no temporary block flow (TBF) exists.

In packet idle mode, the mobile station monitors the relevant paging subchannels on PCCCH, if such is present in the cell. If a PCCCH is not present in the cell, the mobile station monitors the relevant paging subchannels on CCCH.

In packet idle mode, upper layers may require the transfer of a upper layer PDU, which implicitly triggers the establishment of a TBF and the transition to packet transfer mode.

In packet idle mode, upper layers may require the establishment of an RR connection. When the mobile station enters dedicated mode (see 3GPP TS 44.018), it may leave the packet idle mode, if the mobile station limitations make it unable to handle the RR connection and the procedures in packet idle mode simultaneously.

In packet idle mode, if a mobile station starts listening to an MBMS radio bearer, it shall enter broadcast/multicast receive mode (see sub-clause 5.3.1).

### 5.3.1 Broadcast/multicast receive mode

In broadcast/multicast receive mode, the mobile station listens to an MBMS radio bearer.

Broadcast/multicast receive mode can only be entered by a mobile station when in packet idle mode; when leaving broadcast/multicast receive mode, the mobile station shall return to packet idle mode.

Whenever a mobile station leaves broadcast/multicast receive mode to enter packet transfer mode, upon returning to packet idle mode it may re-enter broadcast/multicast receive mode to resume the reception of the ongoing MBMS session(s).

The mobile station receives the system information and paging messages on the (P)BCCH and (P)CCCH as specified for packet idle mode or on the PACCH/D associated with the MBMS radio bearer, depending on the value of the MBMS In-band Signalling Indicator information element included in the MBMS ASSIGNMENT and MBMS NEIGHBOURING CELL INFORMATION messages.

If the use of in-band signalling has been indicated (by the MBMS In-band Signalling Indicator), only mobile stations that have an MS\_ID on the MBMS radio bearer shall be addressed with paging messages on the PACCH/D of that MBMS radio bearer. Mobile stations without an MS\_ID shall continue monitoring their paging groups on the paging channel(s) on the (P)CCCH and skip the reception of the radio blocks of the MBMS radio bearer that prevent the monitoring of their paging groups, if needed. In this specification, requirements for mobile stations in packet idle mode apply also to mobile stations in broadcast/multicast receive mode unless stated otherwise.

## 5.4 Packet transfer mode

In packet transfer mode, the mobile station is allocated radio resources providing one or more TBFs for physical point-to-point connection(s) on one or more packet data physical channels for the unidirectional transfer of upper layer PDUs between the network and the mobile station. Successive transfer of one or more upper layer PDUs is possible. Concurrent TBFs may be established in opposite directions. The RR sublayer provides the following services:

- transfer of upper layer PDUs in RLC acknowledged mode;
- transfer of upper layer PDUs in RLC unacknowledged mode;
- transfer of upper layer PDUs in RLC non-persistent mode.

When a transfer of upper layer PDUs terminates, in either downlink or uplink direction, the corresponding TBF is released. In packet transfer mode, when all TBFs have been released, in downlink and uplink direction, the mobile station returns to packet idle mode.

In packet transfer mode, upper layers may require the establishment of an RR connection. When the mobile station enters dedicated mode (see 3GPP TS 44.018), it may abort all ongoing TBFs and leave the packet transfer mode, if the mobile station limitations make it unable to handle the RR connection and the procedures in packet transfer mode simultaneously.

In packet transfer mode, a mobile station that supports PS handover may be ordered to move to a new cell through the use of a PS HANDOVER COMMAND message that provides resources to be used for one or more of its ongoing TBFs in the new cell (e.g. TBF resources in the new cell that have been pre-allocated by the target BSS). A mobile station indicates that it supports PS handover in the PS Handover Capability field/GAN PS Handover Capability field in the *MS Radio Access Capability* IE (see 3GPP TS 24.008). An E-UTRAN capable mobile station indicates that it supports PS handover to E-UTRAN in the "GERAN to E-UTRAN support in GERAN packet transfer mode" field of the *MS Radio Access Capability* IE (see 3GPP TS 24.008). The network may initiate the PS handover procedure as a result of various trigger conditions as described in sub-clause 8.10.3.1. The PS handover procedure is described in sub-clause 8.10.

### 5.4a Dual transfer mode

In dual transfer mode, the mobile station is allocated radio resources providing an RR connection on a dedicated traffic channel and one or more TBFs on one or more packet data physical channels. The allocation of radio resources for the RR connection and the TBFs is co-ordinated by the network, in agreement with the capabilities of the mobile station in dual transfer mode.

If a mobile station that supports multiple TBF procedures has entered dual transfer mode where an uplink TBF is operating in exclusive allocation mode then no additional uplink TBFs may be requested. If exclusive allocation is not used a mobile station in dual transfer mode that supports multiple TBF procedures may request the establishment of one or more additional uplink TBFs by sending a PACKET RESOURCE REQUEST message on the PACCH. If this occurs and the network determines that re-allocation of the RR connection is required before it can satisfy the requested TBFs it sends the mobile station a DTM ASSIGNMENT COMMAND message to reallocate the RR connection and a combination of one or more ongoing uplink and downlink TBFs as specified in 3GPP TS 44.018.

Successive transfer of one or more upper layer PDUs is possible. Concurrent TBFs may be established in opposite directions. Mobile stations supporting multiple TBF procedures may have multiple concurrent TBFs established in opposite directions. The transfer of upper layer PDUs in RLC acknowledged or RLC unacknowledged mode is provided.

When a transfer of upper layer PDUs terminates, in either downlink or uplink direction, the corresponding TBF is released. In dual transfer mode, when all TBFs have been released, in downlink and uplink directions, the mobile station enters dedicated mode.

In dual transfer mode, at the release of the RR connection, the mobile station may abort all ongoing TBFs and enter packet idle mode. If the mobile station and the network support enhanced DTM CS release procedure the mobile station may continue in packet transfer mode without entering packet idle mode, after the release of the RR connection.

## 5.5 General procedures in packet idle and packet transfer modes

Unless explicitly stated, the requirements in this sub-clause (and sub-clauses) apply only in packet idle mode and in packet transfer mode, neither in dedicated mode nor in dual transfer mode.

### 5.5.1 Mobile station side

The mobile station in either packet idle or packet transfer modes shall monitor the system information broadcast in the cell.

In packet idle mode, the mobile station shall monitor the radio blocks on PCCCH or CCCH, as defined in sub-clauses 5.5.1.5 and 5.5.1.6. The determination of the paging group for the mobile station is defined in 3GPP TS 45.002.

#### 5.5.0.1 Indication of a selected PLMN

A mobile station supporting network sharing shall indicate the selected PLMN to the network when sending an upper layer PDU using a foreign TLLI or a random TLLI (see 3GPP TS 23.003) address for this transmission. The mobile station shall set the value of the *Selected PLMN Index* field in the first RLC data block used to transfer the PDU (see sub-clauses 10.4.14 and 10.4.14a.) to whichever of the following was the most recently received:

- the corresponding PLMN ID index of the selected PLMN, if the selected PLMN is acquired from the system information when the SI22IND field contained in the *Control Channel Description* IE in the SYSTEM INFORMATION TYPE 3 message (see 3GPP TS 44.018) indicates that network sharing is used; or
- the Selected PLMN Index received in the PS HANDOVER COMMAND message; or
- the Selected PLMN index as indicated by the PLMN Index IE received in the CS HANDOVER COMMAND or DTM HANDOVER COMMAND (see 3GPP TS 44.018)

#### 5.5.1.1 Cell reselection

Cell reselection in packet idle and packet transfer modes is specified in 3GPP TS 45.008. The RR entity on the mobile station side indicates to the upper layers the availability of a cell and a cell change when decided by the RR sublayer. Upper layers are advised of system information broadcast in the cell when a new cell has been selected, or when a relevant part of this information changes.

When the mobile station reselects a new (target) cell, the support of GPRS in the target cell is indicated in system information sent on BCCH, see 3GPP TS 44.018. If the mobile station has received a PBCCH description for the target cell, it shall assume that GPRS is supported, without further receiving system information on BCCH.

NOTE: A PBCCH description for the target cell may be received in the packet system information (neighbour cell information in PSI3 and 3bis) and/or in the MBMS NEIGHBOURING CELL INFORMATION message (for a mobile station in broadcast/multicast receive mode) in the old serving cell, or in a BCCH message (SI13) in the target cell.

If a cell supports GPRS, the mobile station may perform packet access. If a cell does not support GPRS, the mobile station is not allowed to perform packet access.

When a cell reselection is determined by the mobile station or ordered by the network, the mobile station may continue its operation in packet idle or in packet transfer mode in the old serving cell, while acquiring certain system information for the target cell.

When a cell reselection is determined by the mobile station in broadcast/multicast receive mode shall leave the old serving cell immediately if the distribution of MBMS NEIGHBOURING CELL INFORMATION messages is not supported in the old serving cell (see sub-clause 7.7.3). If the distribution of MBMS NEIGHBOURING CELL INFORMATION messages is supported in the old serving cell, the mobile station shall continue its operation in broadcast/multicast receive mode in the old serving cell as follows:

- if the mobile station has received for the target cell the MBMS bearer description for each session it is acquiring it shall leave the cell immediately after it receives an MBMS NEIGHBOURING CELL INFORMATION

message for that target cell with the same MBMS\_PTM\_CHANGE\_MARK as the last one received (see note), or after 1s after cell reselection is determined, whichever occurs first;

- otherwise the mobile station shall leave the cell immediately after 1s after cell reselection is determined.

NOTE 1: An MBMS\_PTM\_CHANGE\_MARK is one received in an MBMS NEIGHBOURING CELL INFORMATION message for a session the mobile station is acquiring.

NOTE 2: The behaviour of the mobile station after leaving the old serving cell is described in sub-clause 8.1.6.

If the old cell does not support CCN, the operation in the old cell shall be aborted when one of the following conditions are met:

- the mobile station starts to receive information on PBCCH in the target cell;
- the mobile station has received the SII3 message (see 3GPP TS 44.018) and there is no PBCCH present in the target cell; or
- the criteria for camping on the old cell are no longer fulfilled (see 3GPP TS 45.008).

If PBCCH is present in the target cell, the mobile station shall delay the start of receiving information on PBCCH until the first occurrence of PSI1 in block B0. If the reception of PSI1 or PSI2 messages fails (see sub-clause 5.5.1.2) the mobile station may re-establish and continue its operation in the old cell, until the next occurrence of PSI1 in block B0, unless the mobile station is in broadcast/multicast receive mode and performs fast reception resumption (see sub-clause 8.1.6.2) of at least one MBMS session in the target cell.

While the operation is maintained in the old cell, the mobile station may suspend its TBF(s) or suspend the monitoring of radio blocks on PCCCH and CCCH, in order to receive necessary information on BCCH in the target cell. Such suspension may be required in both packet idle and packet transfer modes, but shall not apply in broadcast/multicast receive mode. It is performed without notification to the network.

Suspension of the operation in the old cell for this purpose is allowed during the time required, for each message and according to the mobile station's multislot class, to receive the required messages on BCCH in the target cell. The allowable suspension of an uplink TBF may be extended with one block period, in case of dynamic or extended dynamic allocation, if the mobile station is unable to receive the corresponding USF due to the suspension of downlink operation.

When the conditions are fulfilled to switch to the new cell, the mobile station shall abort all TBFs in progress by immediately ceasing to decode the downlink, ceasing to transmit on the uplink, stopping all RLC/MAC timers except for timers related to measurement reporting. The mobile station shall then switch to the identified specified new cell and shall obey the relevant RLC/MAC procedures on this new cell.

If the old cell supports CCN, a mobile station shall, when the cell reselection has been determined for other reason than path loss criterion parameter C1 becomes negative, follow the procedures for Network Assisted Cell Change as specified in sub-clauses 5.5.1.1a.2 and 8.8.2.

If the old cell supports CCN, a mobile station may, when the cell reselection has been determined because the path loss criterion parameter C1 has become negative, follow the procedures for Network Assisted Cell Change as specified in sub-clauses 5.5.1.1a.2 and 8.8.2.

Under no circumstances and independent of whether CCN mode is supported, operations in the old cell shall be continued more than 5 s after a cell reselection has been determined.

### 5.5.1.1a Network Assisted Cell Change

The mobile station shall support the Network Assisted Cell Change procedures. The Network Assisted Cell Change consists of two independent procedures:

- One procedure that can assist a mobile station in packet transfer mode or MAC-Shared state with neighbour cell system information for a GSM neighbouring cell required for initial packet access after a cell change;
- one procedure in which the mobile station notifies the network when it has determined to reselect to another GSM, to a 3G, or to an E-UTRAN cell and delays the cell re-selection (CCN mode procedures) to let the network e.g. in the case of reselection to a GSM cell, respond with neighbour cell system information.



The Network Assisted Cell Change procedures are part of the *GERAN Feature Package 1*. A mobile station indicating support of the *GERAN Feature Package 1* in the Mobile Station Classmark 3 IE, the MS Radio Access Capability IE and the MS Radio Access Capability 2 IE supports the Network Assisted Cell Change procedures (see 3GPP TS 24.008).

#### 5.5.1.1a.1 Neighbour Cell System Information Distribution

The network may send GSM neighbour cell system information to a mobile station in packet transfer mode or MAC-Shared state. A mobile station, which receives this information, shall store the information for 30 seconds and during that period the information can be used for initial access in the neighbour cell (see sub-clause 8.8.1).

#### 5.5.1.1a.2 CCN Mode

A mobile station, which has *CCN Enabled*, can enter *CCN Mode*.

The mobile station shall enable CCN when the following criteria are fulfilled:

- the mobile station is camping on a cell (see 3GPP TS 45.008); and
- the network indicates CCN ACTIVE/3G CCN ACTIVE/E-UTRAN CCN ACTIVE either in system information to all mobile stations in the cell or in an individual order to a certain mobile station; and
- the mobile station is neither in dedicated mode nor Dual Transfer Mode; and
- the mobile station is in NC0 or in NC1 mode; and
- the mobile station is in Packet Transfer mode.

The CCN procedures and the criteria for entering and leaving CCN mode are specified in sub-clauses 8.8.2 and 8.8.3.

#### 5.5.1.1b Release of RR connection

##### 5.5.1.1b.1 General

After the release of an RR connection (see 3GPP TS 44.018, *Normal release procedure* and *Abnormal cases*), if the mobile station during the RR connection is unable to monitor the system information broadcast on BCCH or PBCCH (i.e. GPRS class B or GPRS class A mode of operation using DTM), the mobile station shall acquire the system information broadcast in the serving cell. The acquisition of system information shall be performed according to the requirements in sub-clause 5.5.1.2 (PBCCH present in the cell) or sub-clause 5.5.1.3 (PBCCH not present in the cell). The mobile station shall not attempt a packet access or accept a packet downlink assignment before those requirements are fulfilled.

The following exceptions, stated in sub-clauses 5.5.1.1b.2 to 5.5.1.1b.5, may apply.

##### 5.5.1.1b.2 Continuation of PBCCH information

At the establishment of an RR connection and if PBCCH is present in the cell, the mobile station may keep the PSI messages received on PBCCH before the RR connection establishment.

If the RR connection is established, maintained and released in the same serving cell and the MS has received PSI14 messages or received and acted upon PSII messages during dual transfer mode at least every 30 seconds such that

- for PSII, the value of the PBCCH\_CHANGE\_MARK has indicated no change in the PSI messages (see sub-clause 5.5.1.2.1), and
- for PSI14, all instances of the PSI14 messages indicate no change in the contents of PSI messages,

the mobile station may resume the supervision of PBCCH\_CHANGE\_MARK and update of PBCCH information, defined in sub-clause 5.5.1.2.1, and need not initiate a *complete acquisition* of PBCCH information, as specified in sub-clause 5.5.1.2.

### 5.5.1.1b.3 Continuation of BCCH information

At the establishment of an RR connection and if PBCCH is not present in the cell, the mobile station may keep the SI messages received on BCCH before the RR connection establishment.

If the RR connection is established, maintained and released in the same serving cell and the MS has received PSI14 messages or received and acted upon PSI13/SI13 messages during dual transfer mode at least every 30 seconds such that the value of the BCCH\_CHANGE\_MARK has indicated no change in the SI messages (see sub-clause 5.5.1.3.1), the mobile station may resume the supervision of BCCH\_CHANGE\_MARK and update of BCCH information, defined in sub-clause 5.5.1.3.1, and need not initiate a *complete acquisition* of BCCH information, as specified in sub-clause 5.5.1.3.

### 5.5.1.1b.4 Receipt of PSI14 message in dual transfer mode

In dual transfer mode, the mobile station may receive the PSI14 message on PACCH in the serving cell. If the RR connection is released in the same serving cell within 30 s after the PSI14 message was last received, the mobile station may use the PSI14 message as a substitute for the SI13 message after the release of the RR connection, until the SI13 message has been received or the mobile station starts to receive information on PBCCH.

The presence of a PBCCH in the cell is indicated by a PBCCH description in the PSI14 message. If the message does not contain the PBCCH description, the mobile station shall assume that PBCCH is not present in the cell.

After the release of the RR connection and if PBCCH is present in the cell, the mobile station shall perform a *complete acquisition* of PBCCH information, as defined in sub-clause 5.5.1.2.

After the release of the RR connection and if PBCCH is not present in the cell, the mobile station shall perform a *complete acquisition* of BCCH information, as defined in sub-clause 5.5.1.3. The mobile station shall attempt to receive the SI13 (or PSI13) message within 30 s after the last receipt of the PSI14 message.

### 5.5.1.1b.5 Acquisition of system information for enhanced DTM CS release procedure in dual transfer mode

If the mobile station and the network support enhanced DTM CS release procedure, the network may delay the release of the RR connection until the mobile station has received the needed system information, in order to maintain the radio resources on the PDCH(s) after the release of the RR connection.

The network initiates enhanced DTM CS release by sending the PACKET CS RELEASE INDICATION message on PACCH with the ENHANCED\_DTM\_CS\_RELEASE\_INDICATION parameter set to indicate that the RR connection is to be released (i.e. upon subsequent transmission of the CHANNEL RELEASE message to the mobile station) and starts timer T3197.

On receipt of PACKET CS RELEASE INDICATION message with the ENHANCED\_DTM\_CS\_RELEASE\_INDICATION parameter set to indicate that the RR connection is to be released, the mobile station shall send the PACKET SI STATUS (respectively PACKET PSI STATUS if the PBCCH is present) message on PACCH to indicate which system information messages were stored while in the dual transfer mode by the mobile station. The following system information (respectively packet system information) messages are required to maintain radio resources and enter packet transfer mode after the release of the RR connection:

- PSI1, PSI2 and PSI14 in the *Received PSI Message List*; or respectively
- SI13, SI3 and SI1, if present, in the *Received SI Message List*.

The PSI (respectively SI) messages listed above shall be indicated as the first PSI (respectively SI) messages indicated in the PACKET PSI STATUS (respectively PACKET SI STATUS) messages. If other PSI (respectively SI) messages are indicated in the PACKET PSI STATUS (respectively PACKET SI STATUS) message, the priority order defined in Table 5.5.1.4.3.1 shall apply.

In case the mobile station has no information available to determine whether PBCCH is allocated in the cell or not, the mobile station shall transmit the PACKET SI STATUS message where an empty *Received SI Message List* is indicated. Upon reception of such message, the network shall determine that the mobile station has no knowledge whether PBCCH is present in the cell. In this case the network shall start transmitting the PSI messages if PBCCH is present in the cell or, otherwise, SI messages.

The mobile station may request the release of the RR connection and packet resources (e.g. if combined RAU procedure shall be performed after the release of the RR connection) with *PS\_REL\_REQ* field sent in the PACKET SI STATUS (respectively PACKET PSI STATUS) message.

On receipt of the PACKET SI STATUS (respectively PACKET PSI STATUS) message the network shall send the missing system information messages by using the PACKET SERVING CELL SI message or it shall send respectively the corresponding packet system information messages.

The mobile station is allowed to send the PACKET SI STATUS (respectively PACKET PSI STATUS) message twice and the second sending occurrence of this message shall take place at the first suitable opportunity at least one second after the first transmission of that message. Whenever the mobile station has received all required system information (respectively packet system information) messages, it shall send the PACKET SI STATUS (respectively PACKET PSI STATUS) message at the first suitable opportunity, even if it has already sent the PACKET SI STATUS (respectively PACKET PSI STATUS) twice.

When the network receives the PACKET SI STATUS (respectively PACKET PSI STATUS) message indicating that all required system information (respectively packet system information) messages have been received by the mobile station it shall stop timer T3197, start timer T3109 (see 3GPP TS 44.018) and send the CHANNEL RELEASE message on the main DCCH indicating that the mobile station is allowed to continue in packet transfer mode after the release of the RR connection (see 3GPP TS 44.018). Upon reception of the CHANNEL RELEASE message the mobile station shall release the RR connection, continue in packet transfer mode and re-configure the packet resources (if provided by the PACKET CS RELEASE INDICATION message).

If continuous timing advance parameters are provided to the mobile station in the PACKET CS RELEASE INDICATION message, the mobile station shall start the continuous timing advance procedure upon entering packet transfer mode. The mobile station shall use the last timing advance value received whilst in dual transfer mode until a new value of the timing advance is provided to the mobile station according to the procedures defined for packet transfer mode.

If timer T3197 expires before the network receives the PACKET SI STATUS (respectively PACKET PSI STATUS) message indicating that all required system information (respectively packet system information) messages have been received by the mobile station, the network shall release the RR connection by sending the CHANNEL RELEASE message on the main DCCH indicating that the mobile station is not allowed to continue in packet transfer mode after the release of the RR connection (see 3GPP TS 44.018).

### 5.5.1.1c Inter-RAT cell re-selection based on priority information

#### 5.5.1.1c.1 General

The network may provide priority information to enable priority-based cell reselection (see 3GPP TS 45.008). Inter-RAT cell reselection based on priority information applies only in case of autonomous cell reselection.

Two sets of priorities are defined for inter-RAT cell re-selection based on priority information: common priorities (see sub-clause 5.5.1.1c.2) and individual priorities (see sub-clause 5.5.1.1c.3). The mobile station shall delete all priorities when switched off.

While providing common or individual priorities, the network shall ensure that the GERAN priority value is different from all E-UTRAN priority values and from all UTRAN priority values, and that all UTRAN priority values are different from all E-UTRAN priority values. In addition, if for some E-UTRAN frequencies THRESH\_E-UTRAN\_high\_Q is provided in the *Enhanced Cell Reselection Parameters Description* IE in the PACKET MEASUREMENT ORDER message, the network shall ensure that the priority value for any frequency for which THRESH\_E-UTRAN\_high\_Q is provided is different from the priority value for all frequencies for which THRESH\_E-UTRAN\_high\_Q is not provided.

The mobile station shall determine each set, considering only individual priorities (respectively common priorities) when building the set of individual (respectively common) priorities. The mobile station shall perform the following steps, in the specified order:

- If the same priority value is assigned to GERAN and to one or more UTRAN or E-UTRAN frequencies then all such UTRAN and E-UTRAN priority values are considered as not in the set of priorities.
- If the same priority value is assigned to one or more UTRAN frequencies and one or more E-UTRAN frequencies, then all such priority values are considered as not in the set of priorities.

- If the same priority value is assigned to one or more E-UTRAN frequencies for which THRESH\_E-UTRAN\_high\_Q is provided and one or more E-UTRAN frequencies for which THRESH\_E-UTRAN\_high\_Q is not provided then all such priority values are considered as not in the set of priorities.

NOTE 1: These steps mean that if, for example, there are two UTRAN priority values, one E-UTRAN priority value (for a frequency for which THRESH\_E-UTRAN\_high\_Q is provided) and one E-UTRAN priority value (for a frequency for which THRESH\_E-UTRAN\_high\_Q is not provided) that are all the same, then all four priority values are considered as not in the set of priorities.

A set of individual priorities is valid if it contains at least one priority.

A set of common priorities is valid if both of the following conditions are met:

- The set of priorities includes a priority for GERAN;
- The mobile station does not have a valid set of individual priorities.

If the mobile station has a valid set of priorities, the priorities in this set shall be used for priority-based reselection as specified in 3GPP TS 45.008.

NOTE 2: It is possible that individual priorities inherited from UTRAN or E-UTRAN (see sub-clause 5.5.1.1c.3) do not contain a priority for GERAN.

#### 5.5.1.1c.2 Common priorities information

The mobile station may receive common priorities information as specified in 3GPP TS 44.018.

In addition, a mobile station may receive common priorities information in the *Priority and E-UTRAN Parameters Description* IE in the PACKET MEASUREMENT ORDER message.

#### 5.5.1.1c.3 Provision of individual priorities information

The provision of individual priorities information is described in 3GPP TS 44.018.

#### 5.5.1.1d (void)

#### 5.5.1.2 System information on PBCCH

If PBCCH is present in the serving cell, the mobile station shall receive the PACKET SYSTEM INFORMATION (PSI) messages broadcast on PBCCH. The parameters determining the schedule of PSI messages on PBCCH are provided in the PSI1 message.

When a new cell has been selected where PBCCH is present, the mobile station shall perform a *complete acquisition* of PBCCH messages (see 5.5.1.4). The mobile station shall not perform packet access in the selected cell, or enter the packet transfer mode or the MAC-Shared state, until it has:

- acquired the PACKET SYSTEM INFORMATION TYPE 1 (PSI1) message;
- acquired a consistent set of PSI2 messages; and
- made at least one attempt to receive the complete set of PSI messages on PBCCH.

If the network supports the PACKET PSI STATUS message, the mobile station may perform packet access or maintain its radio resources (PDCH(s)) when the RR connection is released while in dual transfer mode, and enter packet transfer mode or the MAC-Shared state, as soon as the PSI1 message and a consistent set of PSI2 messages have been received. In this case, the mobile station shall implement the request for acquisition of system information (see 5.5.1.4.3).

When the PSI1 message has been received, the mobile station shall supervise the PBCCH\_CHANGE\_MARK and perform update of PBCCH information as specified in sub-clause 5.5.1.2.1. In addition, while camping on a cell, the mobile station shall take into account any PSI message that may be received on PCCCH and PACCH.

Once that the mobile station starts to acquire the information on PBCCH, the information sent to a mobile station in RLC/MAC control messages shall be independent of the information provided on the BCCH. If the mobile station receives information in an RLC/MAC control message that depends on the BCCH information, the behaviour of the mobile station is not specified.

#### 5.5.1.2.1 Supervision of PBCCH\_CHANGE\_MARK and update of PBCCH information

While camping on a cell where PBCCH is present, the mobile station shall attempt to receive the PSI1 message at least every 30 seconds. The mobile station shall then take into account any occurrence of the PSI1 message that may be received on PACCH during packet transfer mode or MAC-Shared state. The mobile station shall also take into account any occurrence of the PSI1 message that may be received on PCCCH during periods in packet idle mode or MAC-Idle state. If the PSI1 message is not received, the mobile station shall attempt to receive this message on PBCCH during periods in packet idle mode or MAC-Idle state.

If the mobile station has not received the PSI1 message within the last 30 seconds, it shall attempt to receive the PSI1 message each time it is scheduled on PBCCH. Such attempts shall be made during packet idle mode, packet transfer mode, MAC-Idle state and MAC Shared state. A mobile station in packet transfer mode or MAC-Shared state may suspend its TBF(s) for this purpose (see 5.5.1.4.2).

The PSI1 message contains the PBCCH\_CHANGE\_MARK and PSI\_CHANGE\_FIELD parameters. The mobile station shall store the value of the last PBCCH\_CHANGE\_MARK received.

If the mobile station receives a PBCCH\_CHANGE\_MARK and detects that the value has been incremented by one unit, compared to the previous value, the mobile station shall perform a *partial acquisition* of PBCCH information. The information that shall be received is determined by the PSI\_CHANGE\_FIELD parameter:

- If the PSI\_CHANGE\_FIELD parameter indicates an update of a specific type or specific types of PSI messages, the mobile station shall receive at least one instance of each of the indicated type(s) of PSI messages.
- If the PSI\_CHANGE\_FIELD parameter indicates an update of an unspecified type or types of PSI messages, the mobile station shall receive at least one message instance within each consistent set of PSI messages on PBCCH. It shall also receive all PSI messages on PBCCH not belonging to a consistent set.
- If the PSI\_CHANGE\_FIELD parameter indicates an update of an unknown type of PSI message, the mobile station is not required to receive any PBCCH information.

When a PSI message is received, the mobile station shall consider the PSI *change mark* value, if such is received in the message and take appropriate action (see sub-clause 5.5.1.4.1).

Whenever the mobile station receives a PBCCH\_CHANGE\_MARK and detects that the value has been incremented by more than one unit, compared to the previous value, the mobile station shall perform a *complete acquisition* of PBCCH messages (see sub-clause 5.5.1.4).

#### 5.5.1.2.2 Replacement of PBCCH

The mobile station may receive a PSI1 message indicating that PBCCH is being deactivated in the cell. Moreover, the mobile station may receive a PSI13 message on PACCH or PCCCH providing a different PBCCH description than the one currently being used, or a PSI13 message indicating that PBCCH is not present in the cell.

If the mobile station detects that PBCCH is being deactivated in the cell, or receives an indication that PBCCH is no longer present in the cell, it shall attempt to receive the SI13 message on BCCH. For this purpose, the mobile station may suspend its operation in packet idle mode, packet transfer mode, MAC-Idle state and MAC-Shared state (see 5.5.1.4.2). When the SI13 has been received, further action depends on the contents of the SI13 message:

- If the SI13 message contains a PBCCH description, the mobile station shall perform a *complete acquisition* of PBCCH messages using the indicated PBCCH (see sub-clause 5.5.1.4).
- If the SI13 message does not contain a PBCCH description, the mobile station shall perform a *complete acquisition* of BCCH messages.
- If the mobile station receives a PSI13 message with a PBCCH description different from that currently being used, the mobile station shall perform a *complete acquisition* of PBCCH messages using the new PBCCH.

### 5.5.1.2.3 PSI1 reception failure

If the mobile station has not received the PSI1 message within the last 60 s, a PSI1 reception failure has occurred. A PSI1 reception failure shall result in a cell reselection.

### 5.5.1.3 System information on BCCH

The presence of a PBCCH in the cell is indicated by a PBCCH description in the SI13 message on BCCH. If the mobile station receives an SI13 message without a PBCCH description, it shall assume that PBCCH is not present in the cell. If PBCCH is not present in the serving cell, the mobile station shall receive the SYSTEM INFORMATION (SI) messages broadcast on BCCH.

When a new cell has been selected where PBCCH is not present, the mobile station shall perform a *complete acquisition* of BCCH messages (see sub-clause 5.5.1.4). The mobile station shall not perform packet access in the selected cell, or enter the packet transfer mode, until it has:

- acquired the SYSTEM INFORMATION TYPE 3 (SI3), SI13 and, if present, SI1 messages;
- made at least one attempt to receive other SI messages that may be scheduled within one TC cycle on BCCH (see 3GPP TS 45.002).

If the network supports the PACKET SI STATUS message, the mobile station may perform packet access or maintain its radio resources (PDCH(s)) when the RR connection is released while in dual transfer mode, and enter packet transfer mode, as soon as the SI3, SI13 and, if present, SI1 messages have been received. In this case, the mobile station shall implement the request for acquisition of system information (see sub-clause 5.5.1.4.3).

When the SI13 message has been received, the mobile station shall supervise the BCCH\_CHANGE\_MARK and perform update of BCCH information.

#### 5.5.1.3.1 Supervision of BCCH\_CHANGE\_MARK and update of BCCH information

While camping on a cell where PBCCH is not present, the mobile station shall attempt to receive the SI13 or the PSI13 message at least every 30 s. The mobile station shall then take into account any occurrence of the PSI13 message that may be received on PACCH during packet transfer mode. If PSI13 is not received, the mobile station shall attempt to receive the SI13 message on BCCH during periods in packet idle mode.

If the mobile station has received neither the SI13 nor the PSI13 message within the last 30 s, it shall attempt to receive the SI13 message each time it is scheduled on BCCH. Such attempts shall be made during both packet idle and packet transfer modes. A mobile station in packet transfer mode may suspend its TBF(s) for this purpose (see sub-clause 5.5.1.4.2).

The SI13 and PSI13 messages contain the BCCH\_CHANGE\_MARK and SI\_CHANGE\_FIELD parameters. When camped on a cell where PBCCH is not present, the mobile station shall store the value of the last BCCH\_CHANGE\_MARK received. In that case, if the mobile station detects that the value has been incremented by one unit, compared to the previous value, the mobile station shall perform a *partial acquisition* of BCCH information. The information that shall be received is determined by the SI\_CHANGE\_FIELD parameter:

- If the SI\_CHANGE\_FIELD parameter indicates an update of a specific type or specific types of SI messages, the mobile station shall receive at least one instance of each of the indicated type(s) of SI messages.
- If the SI\_CHANGE\_FIELD parameter indicates an update of an unspecified type or types of SI messages, the mobile station shall receive at least one message instance within each consistent set of SI messages on BCCH. It shall also receive all SI messages on BCCH not belonging to a consistent set.
- If the SI\_CHANGE\_FIELD parameter indicates an update of an unknown type of SI message, the mobile station is not required to update any BCCH information.

When an SI message is received, the mobile station shall consider a SI *change mark* value, if such is received in the message and take appropriate action (see sub-clause 5.5.1.4.1).

If the mobile station detects that the BCCH\_CHANGE\_MARK value has been incremented by more than one unit, compared to the previous value, the mobile station shall perform a *complete acquisition* of BCCH messages (see sub-clause 5.5.1.4).

### 5.5.1.3.2 Establishment of PBCCH

The mobile station may receive an SI13 or PSI13 message providing a PBCCH description indicating that PBCCH is present in the cell. The mobile station shall then perform a *complete acquisition* of PBCCH messages using the indicated PBCCH (see sub-clause 5.5.1.4).

### 5.5.1.3.3 SI13 reception failure

If the mobile station has not received the SI13 or the PSI13 message within the last 60 s, a SI13 reception failure has occurred. An SI13 reception failure shall result in a cell reselection.

### 5.5.1.4 Acquisition of system information on the broadcast channel

This procedure shall be used by a mobile station that supports GPRS (in *A/Gb mode*) or *Iu mode* in order to perform a complete or partial acquisition of either PBCCH or BCCH information. As part of this procedure, the mobile station may implement the request for acquisition of system information as specified in sub-clause 5.5.1.4.3.

When PBCCH is not present in a cell this procedure starts:

- when the mobile station is camped on BCCH and receives a BCCH\_CHANGE\_MARK or *SI change mark* value indicating that system information is changed.

When PBCCH is present in a cell this procedure starts:

- when the mobile station is camped on PBCCH and receives a PBCCH\_CHANGE\_MARK or *PSI change mark* value indicating that packet system information is changed.

Moreover, the procedure shall start at any other indication, which may be received by the mobile station, that the stored system information for the serving cell is no longer valid.

At cell selection or cell reselection, in case PBCCH is present in the target cell, this procedure starts when the mobile station starts to receive the information on PBCCH. In case PBCCH is not present in the target cell, the procedure starts when the mobile station has received the SI13 message.

In a *complete acquisition* of either PBCCH or BCCH information, the mobile station shall receive all PSI or SI messages that are scheduled on the respective broadcast channel. The mobile station shall delete any PSI or *SI change mark* value that was stored before the acquisition of PBCCH or BCCH information started.

In a *partial acquisition* of either PBCCH or BCCH information, only a certain subset of the PSI or SI messages that are scheduled on the respective broadcast channel shall be received. The mobile station may consider the state of the PSI or *SI change mark* values, without restriction, to reduce the total number of messages to receive.

When the mobile station acquires a set of PSI or SI messages on the respective broadcast channels, it may receive these messages during packet idle mode, packet transfer mode, MAC-Idle state, MAC-Shared state and broadcast/multicast receive mode. While the mobile station is in packet idle mode or MAC-Idle state or broadcast/multicast receive mode if the network has indicated that the system information is not sent on the PACCH, an attempt to receive a required message shall be made each time the message is scheduled on the broadcast channel, until the message is received. While the mobile station is in packet transfer mode, MAC-Shared state or broadcast/multicast receive mode if the network has indicated that the system information is sent on the PACCH, it shall receive any PSI message that is sent by the network on PACCH. While the mobile station is in dual transfer mode or MAC-DTM state, it may disregard any PSI message except PSI14 message that is sent by the network on PACCH.

If the mobile station has not received the required messages within 10 seconds after the start of this procedure, an attempt to receive a missing message shall be made each time the message is scheduled on the broadcast channel. These attempts shall then be performed during packet idle mode, packet transfer mode, MAC-Idle state, MAC-Shared state and broadcast/multicast receive mode. A mobile station in packet transfer mode or MAC-Shared state may suspend its TBF(s) for this purpose, as specified in 5.5.1.4.2. A mobile station in broadcast/multicast receive mode may skip the reception of radio blocks of the MBMS radio bearer for the same purpose, as specified in 5.5.1.4.2.

A second acquisition of either PBCCH or BCCH information may be initiated (e.g. when the mobile station receives a PSI or *SI change mark* value) before a previous acquisition is completed. In this case, the mobile station shall discard and immediately begin re-acquiring all the system information messages of the particular type to which the changemark value refers.

To allow future extension of PSI message types, the mobile station may disregard a message in a position within the schedule of PSI messages on PBCCH, where it receives a valid RLC/MAC control block, but diagnoses an unknown or unexpected (non-PSI) message type. When this condition is detected, the mobile station needs not to receive the PBCCH block in this position again, until a change in the schedule of PBCCH messages is detected or a *complete acquisition* of PBCCH information is required.

#### 5.5.1.4.1 Consistent sets of system information messages

A mobile station, receiving a PSI or SI message belonging to a consistent set of system information messages, shall store the last PSI or SI *change mark* value received for the set of messages (see table 5.5.2.1.4.1). A mobile station lacking all non-GSM capabilities defined for PSI6, PSI7, SI 18 or SI 20 shall consider those message as irrelevant when making a determination of whether or not a consistent set of system information messages has been received.

A mobile station that does not support UTRAN shall consider a PSI3quater message as irrelevant when making a determination of whether or not a consistent set of system information messages has been received.

Whenever mobile station receives a PSI or SI *change mark* value, which is not equal to the previously stored value for the set of messages, the mobile station shall perform a *partial acquisition* of either PBCCH or BCCH information. It shall then receive all instances of the PSI or SI messages belonging to the consistent set of system information messages.

If a mobile station detects an inconsistency amongst the PSI or SI *count* and *index* parameters within a consistent set of system information messages or any other inconsistency making the information that is contained invalid, the mobile station shall discard the messages received so far and delete the stored PSI or SI *change mark* value. The mobile station may then restart the acquisition of the affected system information messages.

#### 5.5.1.4.2 Suspension of operation to receive system information

During certain conditions, the mobile station in packet transfer mode or MAC-Shared state is allowed to suspend its TBF(s) to receive certain information on PBCCH or BCCH. A mobile station in broadcast/multicast receive mode may suspend the reception of radio blocks of the MBMS radio bearer for the same purpose. Such suspension is made without notification to the network.

Suspension of its TBF(s) or suspension of the reception of radio blocks of the MBMS radio bearer for this purpose is allowed during the time required, for each message and according to the mobile station's multislot class, to receive the required messages on PBCCH or BCCH. The allowable suspension of an uplink TBF may be extended with one block period, in case of dynamic or extended dynamic allocation, if the mobile station is unable to receive the corresponding USF due to the suspension of downlink operation. In case it conflicts with the transmission of a polling response, priority shall be given to the acquisition of blocks on the PBCCH or BCCH channel.

#### 5.5.1.4.3 Request for acquisition of system information

As an option, the mobile station may implement the request for acquisition of system information. If the network supports the PACKET PSI STATUS message or the PACKET SI STATUS message, the mobile station shall then send the PACKET PSI STATUS message to the network, each time an acquisition of PBCCH information is initiated or the PACKET SI STATUS message to the network, each time an acquisition of BCCH information is initiated.

A mobile station supporting the Network Assisted Cell Change or enhanced DTM CS release procedures shall implement the request for acquisition of system information (see sub-clauses 5.5.1.1a and 5.5.1.1b.5).

The PACKET SI STATUS message shall always contain the PSCSI\_SUPPORT field.

The PACKET PSI STATUS (respectively PACKET SI STATUS) message shall indicate the present status of PSI (respectively SI) messages stored in or requested but not received by the mobile station. The mobile station shall include as many PSI (respectively SI) message types that fit into the *Received PSI Message List* (respectively *Received SI Message List*) construction in the PACKET PSI STATUS (respectively PACKET SI STATUS) message and that meet the following criteria:

- The PSI (respectively SI) message type is relevant for the mobile station, based on the features the mobile station supports (e.g. non-GSM and multi-RAT capabilities); and
- In case of optional PSI (respectively SI) messages types, the PSI (respectively SI) message type shall be indicated by the network as present on PBCCH (respectively BCCH).



If the presence of an optional PSI (respectively SI) message type cannot be determined, based on the information received, the mobile station shall assume that the optional PSI (respectively SI) message type is present.

NOTE 1: On PBCCH, the presence of optional PSI messages is indicated in PSI1 and PSI2.

NOTE 2: On BCCH, SI2, SI3, SI4 and, if present, SI9 indicate the presence of optional SI messages, except SI1. The presence of SI1 can be determined by reading the BCCH Norm block at TC = 0.

The "ADDITIONAL\_MSG\_TYPE" information should reflect whether all PSI (respectively SI) message types that satisfy the criteria given above fit into a given PACKET PSI STATUS (respectively PACKET SI STATUS) message or not.

The message type value for these PSI (respectively SI) messages shall be included in the *Received PSI Message List* (respectively *Received SI Message List*) in the PACKET PSI STATUS (respectively PACKET SI STATUS) message. The message types that may be indicated are given in table 5.5.1.4.3.1. The message types shall be indicated in descending order of priority. The network may use this information to determine which PSI (respectively SI) message types the mobile station is able to receive and the present status of the PSI (respectively SI) messages stored in the mobile station.

**Table 5.5.1.4.3.1: Message types that may be indicated at a request for acquisition of system information during packet transfer mode**

Type of status message	PSI (respectively SI) message types, descending order of priority
PACKET PSI STATUS message	PSI2 ( <i>highest priority</i> ), PSI3, PSI3bis, PSI5, PSI3ter, PSI3quater, PSI6, PSI7, and PSI8 ( <i>lowest priority</i> )
PACKET SI STATUS message	SI1 ( <i>highest priority</i> ), SI3, SI2, SI2bis, SI2ter, SI2quater, SI4, SI2n, SI7, SI8, SI9, SI15, SI16, SI17, SI18, SI20 and SI19 ( <i>lowest priority</i> )

During a partial acquisition of PSI (respectively SI) messages, see sub-clause 5.5.1.4, the mobile station may need to obtain the current PSI (respectively SI) *change mark* value for certain types of PSI (respectively SI) messages. In that case, the mobile station may use this procedure and indicate the present status for that PSI (respectively SI) message type in the PACKET PSI STATUS (respectively PACKET SI STATUS) message, except that the message instance corresponding to the PSI (respectively SI) *index* parameter = 0 shall be indicated as not received.

The PACKET PSI STATUS (respectively PACKET SI STATUS) message may also be used to indicate the message type of a PSI (respectively SI) message that is required but has not been received by the mobile station.

The PACKET PSI STATUS (respectively PACKET SI STATUS) message is sent on PACCH when the mobile station is in packet transfer mode or MAC-Shared state. The first sending of this message during the acquisition of PBCCH (respectively BCCH) information shall take place at the first suitable opportunity after the acquisition is initiated. This is also allowed during the contention resolution.

During the acquisition of PBCCH (respectively BCCH) information, up to four PACKET PSI STATUS (respectively PACKET SI STATUS) messages may be sent to the network. The second sending occurrence of this message shall take place at the first suitable opportunity at least one second after that the message is sent the first time. Further sending occurrences shall take place at the first suitable opportunity at least two seconds after that the message was sent the previous time. At each sending occurrence, this message shall be updated according to the present status of PSI (respectively SI) messages in the mobile station.

The PACKET PSI STATUS (respectively PACKET SI STATUS) message shall not be sent when the mobile station has started to suspend its TBF(s) in order to receive the required PSI (respectively SI) messages on PBCCH (respectively BCCH). The PACKET PSI STATUS (respectively PACKET SI STATUS) message shall not be sent when the mobile station has acquired the complete set of PSI (respectively SI) messages on PBCCH (respectively BCCH), unless a new partial or full acquisition of system information is required.

### 5.5.1.5 Discontinuous reception (DRX)

A mobile station in packet idle mode shall listen to the radio blocks on CCCH or PCCCH as defined in 3GPP TS 45.002.

In the *GPRS attach procedure*, defined in 3GPP TS 24.008, the mobile station requests values for the SPLIT\_PG\_CYCLE and NON\_DRX\_TIMER parameters to be applied on CCCH or PCCCH.

NOTE: The support of the SPLIT\_PG\_CYCLE parameter is optional on CCCH, see 3GPP TS 45.002.

The SPLIT\_PG\_CYCLE and NON\_DRX\_TIMER parameters control:

- the occurrence of paging blocks on CCCH or PCCCH belonging to the mobile station (SPLIT\_PG\_CYCLE parameter, see 3GPP TS 45.002) in DRX mode (see 3GPP TS 43.064); and
- the duration of the non-DRX mode period to be applied by the mobile station when it has left the packet transfer mode or the dual transfer mode and then enters the packet idle mode.

There are five cases when the mobile station shall enter a non-DRX mode period.

- 1) At the transition from the packet transfer mode to the packet idle mode, the mobile station shall enter the Transfer non-DRX mode period.
- 2) At the transition from the dual transfer mode to the dedicated mode or packet idle mode, the mobile station shall enter the Transfer non-DRX mode period.

In both cases, the duration of the Transfer non-DRX mode period is determined by value of the NON\_DRX\_TIMER parameter, requested in the *GPRS attach procedure*, and the value of the DRX\_TIMER\_MAX parameter broadcast in the cell. The mobile station may use the minimum value of these two parameters.

If the mobile station receives a new value of the DRX\_TIMER\_MAX parameter during the Transfer non-DRX mode period, the mobile station may wait to apply the new value until the next time the Transfer non-DRX mode period is entered.

- 3) A mobile station operating in NC2 mode shall enter the NC2 non-DRX mode period when it sends an NC measurement report. The duration of this period is defined by the NC\_NON\_DRX\_PERIOD parameter.
- 4) When initiating the MM procedures for *GPRS attach* and *routing area update* defined in 3GPP TS 24.008, the mobile station shall enter the MM non-DRX mode period. This period ends when either of the messages GPRS ATTACH ACCEPT, GPRS ATTACH REJECT, ROUTING AREA UPDATE ACCEPT or ROUTING AREA UPDATE REJECT is received by the mobile station. This period also ends after timeout when waiting for any of these messages.
- 5) The mobile station shall enter the MBMS non-DRX mode period when it receives a pre-notification for an MBMS service and MBMS session, and the MBMS service is a broadcast service or is a multicast service previously joined by the mobile station and the MBMS session has not yet been received by the mobile station. The mobile station shall also enter the MBMS non-DRX mode period, if not already in it, when the mobile station sends the MBMS SERVICE REQUEST message, unless the MBMS packet access procedure is performed on MPRACH during fast reception resumption. The mobile station shall also enter the MBMS non-DRX mode period, if not already in it, when it receives a notification for an MBMS service and MBMS session, and the MBMS service is a broadcast service or is a multicast service previously joined by the mobile station and the MBMS session has not yet been received by the mobile station, and the notification:
  - indicates that no counting shall be performed and contains no MBMS p-t-m channel description;
  - or, specifies an MBMS radio bearer starting time which has not yet elapsed.

The MBMS non-DRX mode period ends when a notification (containing an MBMS p-t-m channel description) or the MBMS ASSIGNMENT message, addressing the same MBMS session and not specifying an MBMS radio bearer starting time or specifying an MBMS radio bearer starting time already elapsed, is received by the mobile station. If the notification or the MBMS ASSIGNMENT message specifies an MBMS radio bearer starting time which has not yet elapsed, the period ends when the point in time denoted by the MBMS radio bearer starting time occurs, unless any subsequent notification or MBMS ASSIGNMENT message addressing the same MBMS session and received by the mobile station, before the point in time denoted by the MBMS radio bearer starting time, provides an up-to-date value of the MBMS radio bearer starting time or does not include an MBMS radio bearer starting time.

The MBMS non-DRX mode period also ends after timeout when waiting for the MBMS notification of the pre-notified MBMS service and MBMS session or after timeout when waiting for the MBMS ASSIGNMENT message.

The non-DRX mode periods defined above run independent of each other and may overlap. The non-DRX mode periods have effect only in packet idle mode. In packet idle mode, the mobile station shall be in non-DRX mode during any of the non-DRX mode periods. Otherwise, the mobile station in packet idle mode may be in DRX mode.

If the mobile station establishes an RR connection during any of the non-DRX mode periods, then that period shall continue to run.

### 5.5.1.6 Page mode procedures on PCCCH

The network sends page mode information in all downlink message on PCCCH (and PACCH, see note). The page mode information controls possible additional requirements on a mobile station receiving the message.

**NOTE:** PCCCH, PDTCH and PACCH may be operated in frame stealing mode on the same PDCH. A mobile station in packet idle mode or MAC-Idle state shall consider any RLC/MAC control message received in such a radio block as belonging to PCCCH. A mobile station in packet transfer mode, dual transfer mode, MAC-Shared state or MAC-DTM state shall consider any RLC/MAC control message received as belonging to PACCH.

A mobile station in packet transfer mode, dual transfer mode, MAC-Shared state or MAC-DTM state shall not consider the page mode information received in any message that is received on a PDCH.

A mobile station in packet idle mode or MAC-Idle state shall take into account the page mode information in any message received in a radio block on PCCCH corresponding to its paging group. The mobile station shall not take into account the page mode information in a message received in any other radio block than those corresponding to its paging group. The requirements yielded by the page mode information are as follows:

- *normal paging*: no additional requirements;
- *extended paging*: the mobile station is required in addition to receive and analyse the possible message in the third block period on PCCCH where paging may occur (PPCH), following the block corresponding to MS's paging group;
- *paging reorganization*: The mobile station shall receive all messages on the PCCCH regardless of the BS\_PAG\_BLK\_RES setting. It is required to receive all PCCCH messages. When the mobile station receives the next message to its (possibly new) paging group, subsequent action is defined by the page mode information in that message;
- *same as before*: no change of page mode from the previous page mode.

Note that a mobile station takes into account the page mode information only in packet idle mode or MAC-Idle state and only in messages received in a radio block corresponding to its paging group, whatever the currently applied requirements are (normal paging, extended paging or paging reorganization).

When the mobile station selects a new PPCH, the initial page mode in the mobile station shall be set to paging reorganization. If an RLC/MAC block in a paging sub-channel does not contain page mode information, or if it is not received correctly, the default page mode information is *same as before*.

### 5.5.1.7 Frequency Parameters

Frequency parameters may be included in the packet assignment messages (i.e., PACKET DOWNLINK ASSIGNMENT, MULTIPLE TBF DOWNLINK ASSIGNMENT, PACKET UPLINK ASSIGNMENT, MULTIPLE TBF UPLINK ASSIGNMENT, PACKET TIMESLOT RECONFIGURE, MULTIPLE TBF TIMESLOT RECONFIGURE or PACKET CS RELEASE INDICATION messages) or in the PS HANDOVER COMMAND message and define the training sequence codes(s) (TSC) and the radio frequency channels or set of radio frequency channels the mobile station is to use during the assigned TBF(s). The first packet assignment message, sent to the mobile station when it enters packet transfer mode or MAC-Shared state, shall include the frequency parameters. Subsequent packet assignment messages, sent to the mobile station during packet transfer mode or MAC-Shared state, may omit the frequency parameters. If a mobile station receives a subsequent packet assignment message, during packet transfer mode or MAC-Shared state, without the frequency parameters, the mobile station shall continue to use the previously assigned frequency parameters.

A packet assignment message, when sent to a mobile station in dual transfer mode or MAC-DTM state, shall not include the frequency parameters for the carrier supporting the dedicated resources in a Downlink Dual Carrier

configuration. If the network intends to change the frequency allocation of the carrier supporting the dedicated resources for a mobile station in dual transfer mode or MAC-DTM state, the network may use the DTM assignment procedure defined in 3GPP TS 44.018.

If the network and mobile station both support Downlink Dual Carrier, the network may send a packet assignment message or a PS HANDOVER COMMAND message to a mobile station specifying packet resources for one or more TBFs on two carriers (referred to as carrier 1 and carrier 2) and thereby establish a Downlink Dual Carrier configuration. If the packet assignment message is sent to a mobile station in packet idle mode, this message shall include frequency parameters for both carriers. If this message is sent to a mobile station which is in packet transfer mode (and is not in a Downlink Dual Carrier configuration) the assignment message shall either:

- provide new frequency parameters for both carriers, or
- provide frequency parameters for only one carrier (carrier 2) in which case the frequency parameters for carrier 1 remain unchanged.

Subsequent packet assignment messages sent to a mobile station in a Downlink Dual Carrier configuration may:

- include frequency parameters which correspond to the frequency parameters already in use for one or both carriers; or
- provide no new frequency parameters, in which case the existing parameters continue to apply; or
- provide new frequency parameters for both carriers; or
- provide new frequency parameters for only one carrier, in which case the frequency parameters for the other carrier remain unchanged.

If the network and mobile station both support Downlink Multi Carrier, the network may send a packet assignment message (i.e. PACKET DOWNLINK ASSIGNMENT or PACKET TIMESLOT RECONFIGURE messages) or a PS HANDOVER COMMAND message to a mobile station specifying packet resources that establish a DLMC configuration. The PS HANDOVER COMMAND message shall always provide new frequency parameters for use in the new cell whereas the packet assignment message may:

- provide new frequency parameters for all newly assigned and existing carriers, or
- provide new frequency parameters for all newly assigned carriers, modify the frequency parameters for a subset of the existing carriers and leave the frequency parameters for the remaining existing carriers unchanged.

When a mobile station has resources assigned on only one carrier then, for the purposes of subsequent packet assignment messages, that carrier shall be considered carrier 1. A subsequent packet assignment message may assign resources on a second carrier, thereby establishing a Downlink Dual Carrier configuration; in this case, the packet assignment message shall provide frequency parameters for a second carrier (carrier 2) for use in a Downlink Dual Carrier configuration. Similarly, a subsequent packet assignment message may assign resources on one or more additional carriers, thereby establishing a DLMC configuration; in this case, the packet assignment message shall provide DLMC frequency parameters as required for use in a DLMC configuration.

A packet assignment message sent to a mobile station in packet transfer mode may specify frequency parameters for one or (in the case of a mobile station with a downlink dual carrier configuration) both carriers which are different from those currently in effect for that mobile station only in the following cases:

- a) the assignment message is a PACKET TIMESLOT RECONFIGURE or MULTIPLE TBF TIMESLOT RECONFIGURE message.
- b) the assignment message is a PACKET DOWNLINK ASSIGNMENT message (respectively PACKET UPLINK ASSIGNMENT message) being sent to a mobile station which has no ongoing uplink (respectively downlink) TBF(s).
- c) the assignment message is a MULTIPLE TBF DOWNLINK ASSIGNMENT message (respectively MULTIPLE TBF UPLINK ASSIGNMENT message) being sent to a mobile station which is or, after this assignment, will be in a downlink dual carrier configuration and has no ongoing uplink (respectively downlink) TBF(s); in this case, the ongoing downlink (respectively uplink) TBFs are implicitly reassigned on the new frequency parameters with all other parameters for those TBFs unchanged.

- d) the assignment message is a PACKET DOWNLINK ASSIGNMENT message (respectively PACKET UPLINK ASSIGNMENT message) sent to a mobile station with a downlink dual carrier configuration, where the frequency parameters for only one carrier are changed, and where no ongoing uplink (respectively downlink) TBF(s) had resources assigned on that carrier.

In cases c) and d) above, a format of the message which includes the Carrier ID field shall be used.

When assigning resources on one carrier to a mobile station which is currently in a Downlink Dual Carrier configuration using a format of the message which does not include the Carrier ID field, the network shall always include frequency parameters; if one or more TBFs which are ongoing are not explicitly addressed in the packet assignment message and will remain ongoing after the new assignment, the included frequency parameters shall be those in use for either carrier 1 or carrier 2.

A packet assignment message sent to a mobile station in packet transfer mode with a DLMC configuration may specify frequency parameters for one or more carriers which are different from those currently in effect for that mobile station only in the following cases:

- a) the assignment message is a PACKET TIMESLOT RECONFIGURE message.
- b) the assignment message is a PACKET DOWNLINK ASSIGNMENT message sent to a mobile station which has no ongoing uplink TBF.
- c) the assignment message is a PACKET DOWNLINK ASSIGNMENT message sent to a mobile station which has an ongoing uplink TBF, subject to the restriction that all existing carriers on which USF is monitored remain assigned.
- d) the assignment message is a PACKET UPLINK ASSIGNMENT message for the case where the ongoing downlink TBF is not modified.

The Frequency Parameters information element is defined in sub-clause 12.8 and the Dual Carrier Frequency Parameters information element is defined in sub-clause 12.8.2 and the DLMC Frequency Parameters information element is defined in sub-clause 12.8.4. The frequency parameters may use an ARFCN defining a non-hopping radio frequency channel, or use the indirect encoding, direct encoding 1 or direct encoding 2 defining a hopping radio frequency channel.

The indirect encoding defines the assigned set of radio frequency channels by referencing information stored within the mobile station. Such information may be received on PBCCH or BCCH (see sub-clauses 5.5.2.1, 11.2.19, 12.8 and 12.10a and 3GPP TS 44.160), or be received in a previous assignment message using one of the direct encoding options. An MA\_NUMBER identifies which of up to eight stored sets of frequency parameters is to be used. The MA\_NUMBER shall use the following coding:

- |                  |  |
|------------------|--|
| MA_NUMBER = 0-13 | shall be used to reference a GPRS mobile allocation received in a PSI2 message;  |
| MA_NUMBER = 14   | shall be used to reference a GPRS mobile allocation received in a SI13 or PSI13 message;                                 |
| MA_NUMBER = 15   | shall be used to reference a GPRS mobile allocation received in a previous assignment message using the direct encoding. |

When the indirect encoding is used, the network may include a CHANGE\_MARK\_1 and a CHANGE\_MARK\_2 in the Frequency Parameters information element. The mobile station shall then verify that it is using a set of PBCCH or BCCH information identified by a PSI or SI *change mark* corresponding to one of the CHANGE\_MARK\_1 or 2 parameters, for the decoding of the frequency information. If that is not the case, an abnormal condition occurs.

The direct encoding defines the assigned set of radio frequency channels by using information contained within the assignment message. The direct encoding 1 references the cell allocation or reference frequency lists received on PBCCH for the decoding of this information. The direct encoding 2 is self contained. When the direct encoding 1 or 2 is used, the mobile station shall store the received GPRS mobile allocation for possible later reference in an assignment message using the indirect encoding. Such reference shall be made using the MA\_NUMBER = 15.

- NOTE: If there is a GPRS mobile allocation associated with MA\_NUMBER = 15, the association shall be kept unchanged if the mobile station receives a packet assignment using the indirect encoding (referencing any value of the MA\_NUMBER), the frequency parameters are not included in the packet assignment (i.e., in packet transfer mode, dual transfer mode, MAC-Shared state or MAC-DTM state) or the mobile station establishes an RR connection (for A/Gb mode) or is allocated a DBPSCH (for Iu mode).

For the decoding of frequency parameters, the mobile station shall be able to store the following frequency information (see sub-clauses 11.2.19, 12.8 and 12.10a):

- four Reference Frequency Lists received in the PSI2 information and the corresponding RFL\_NUMBERS for identification, each RFL having a contents length of up to 18 octets;
- a Cell Allocation received in the PSI2 information referencing up to four RFLs;
- seven GPRS Mobile Allocations received in the PSI2 or the SI13/PSI13 information and the corresponding MA\_NUMBERS for identification, each GPRS Mobile Allocation information element having a length of up to 12 octets (96 bits); and
- one GPRS mobile allocation received in an assignment message using direct encoding 1 or 2, consisting of either a GPRS Mobile Allocation information element having a length of up to 12 octets (96 bits) or a MA Frequency List having a contents length of up to 18 octets.

The mobile station shall be able to store the frequency information for the PCCCH description corresponding to its own PCCCH\_GROUP (see sub-clause 11.2.19).

If the mobile station supports SMSCB, it shall be able to store the frequency information for the CBCH to be used in packet idle mode or MAC-Idle state.

The frequency information that the mobile station has stored while camping on a cell shall be deleted when the mobile station reselects a new cell.

### 5.5.1.8 TLLI management

In case the mobile station receives a message assigning a new P-TMSI from the network during the contention resolution procedure, the mobile station shall continue to use the old TLLI until the contention resolution is completed.

After contention resolution the mobile station shall apply new TLLI in RLC/MAC control block if the mobile has received a new P-TMSI.

The BSS shall not include TLLI within RLC/MAC control messages it sends to a mobile station in packet transfer mode.

### 5.5.1.9 Packet Flow Context (PFC)

Packet Flow Context (PFC) procedures are described in 3GPP TS 23.060. A Packet Flow Identifier (PFI) is used to identify a PFC.

Mobile station support of packet flow context (PFC) procedures is indicated in the *MS Network Capability IE* (see 3GPP TS 24.008). Network support of packet flow context (PFC) procedures is indicated by the PFC\_FEATURE\_MODE parameter that is broadcast on either the BCCH or PBCCH. If the PFC\_FEATURE\_MODE field indicates that the network does not support PFC procedures then a mobile station shall not indicate a PFI value during uplink TBF establishment. If the PFC\_FEATURE\_MODE field indicates that the network supports PFC procedures then a mobile station may indicate a PFI value during uplink TBF establishment. The PFI value identifies the initial PFC used during the TBF.

If the network or the mobile station indicates it supports multiple TBF procedures (see sub-clause 7.0) then it shall also indicate support for PFC procedures. When the network and the mobile station both support multiple TBF procedures then the mobile station shall indicate the PFI value associated with each uplink TBF it attempts to establish and the network shall indicate the PFI value associated with each downlink TBF it attempts to establish.

If the network or the mobile station indicates it supports Enhanced Multiplexing for Single TBF (see sub-clause 5.10) then it shall also indicate support for PFC procedures. The mobile station supporting EMST shall indicate the PFI value associated with each RLC entity it requests to establish on an uplink TBF if the network indicates the support of PFC procedures. When EMST is used on a given TBF, the network shall always indicate the PFI value associated with each RLC entity it establishes on that TBF.

EMSR requires the support of PFC procedures in both the network and the mobile station (see sub-clause 5.10). A mobile station that supports EMSR shall always indicate the PFI value associated with each PFC for which it requests resources from a network that supports PFC procedures. A network that supports EMSR shall always indicate the PFI

value associated with each PFC it establishes on a given RLC entity when sending an assignment message to a mobile station that supports EMSR (see sub-clause 5.2.2).

A network or mobile station that supports PS handover or DTM handover shall also support PFC procedures.

In case no valid PFI value is assigned for the LLC data to be transmitted, and the network indicates support for the PFC procedures, an MS supporting PFC procedures shall associate and indicate the following PFI values for the LLC data:

PFI=0	(Best Effort) for user data,
PFI=1	(Signalling) for GMM/SM signalling (LLC SAPI 1), or
PFI=2	(SMS) for Short Message Service (LLC SAPI 7), or
PFI=3	(TOM8) for LLC SAPI 8 data.

### 5.5.1.10 Acquisition of E-UTRAN Information on the PACCH

An MS that receives a full set of instances of the PACKET MEASUREMENT ORDER message that includes one or more IEs used to provide E-UTRAN related information shall proceed as follows:

- The information provided by all instances of the *Repeated E-UTRAN Neighbour Cells* IE shall be added to the E-UTRAN Neighbour Cell list built by the last received consistent set of SI2quarter message instances, or the last received consistent set of SI23 message instances if SI23 is broadcast in the cell and for a mobile station supporting network sharing (see sub-clause 5.6.3.1a).
- The information provided by all instances of the *Repeated E-UTRAN Not Allowed Cells* IE for any given frequency shall be used to build a new E-UTRAN Not Allowed Cells list for that frequency.
- The information provided by all instances of the *Repeated E-UTRAN PCID to TA mapping* IE for any given frequency shall be used to build new E-UTRAN PCID to TA mapping for that frequency.

If an MS receives a full set of instances of the PACKET MEASUREMENT ORDER message that excludes an IE used to provide E-UTRAN related information that was provided within the last received consistent set of SI2quarter (or alternatively SI23) message instances (e.g. the *Priority and E-UTRAN Parameters Description struct* provides a "0" for the *E-UTRAN Parameters Description* IE), the MS shall resort back to using the corresponding information provided by the last received SI2quarter (or alternatively SI23) message (see NOTE).

If an MS receives a full set of instances of the PACKET MEASUREMENT ORDER message that includes an IE used to provide E-UTRAN related information that was provided within the last received consistent set of SI2quarter (or alternatively SI23) message instances but none of the fields associated with the included IE provide any information, the MS shall resort back to using the corresponding information provided by the last received SI2quarter (or alternatively SI23) message (see NOTE).

If an MS receives a full set of instances of the PACKET MEASUREMENT ORDER message that includes an IE used to provide E-UTRAN related information but only a subset of the fields associated with the included IE actually provide information, the MS shall use the fields that provide information to update their corresponding stored parameters and shall use values for the fields for which no information was provided as described in Table 11.2.9b.2.

If an MS receives a full set of instances of the PACKET MEASUREMENT ORDER message that limits the information provided within the *Repeated E-UTRAN Not Allowed Cells* IE to only providing one or more E-UTRAN frequency indices (i.e. only the E-UTRAN\_FREQUENCY\_INDEX field contains information), the MS shall ignore this IE.

**NOTE:** If the last received consistent set of SI2quarter (or alternatively SI23) message instances has not provided a value for any given E-UTRAN related parameter then the MS uses the default value for that parameter unless otherwise specified.

## 5.5.2 Network side

### 5.5.2.1 System Information broadcasting

#### 5.5.2.1.1 System information on PBCCH

If PBCCH is present in the cell, the network regularly broadcasts PACKET SYSTEM INFORMATION TYPE (PSI) 1, 2, 3 and 3bis messages, and optionally PSI3ter, PSI3quater and some types of PSI messages on the PBCCH. The PSI 2, PSI 3bis, PSI3 ter, PSI3quater messages and some further types of PSI messages may be broadcast in multiple number of instances. Based on the information broadcast in PSI messages, the mobile station is able to decide whether and how it may gain access to the system via the current cell.

NOTE: The network should take into account the limitations of earlier version of mobile equipments to understand the 3-digit MNC format of the location area identification, see sub-clause 12.23 and 3GPP TS 44.018, table "Location Area Identification .information element".

Instances of the PSI 5 message are broadcast on PBCCH if the mobile stations camping on the cell shall perform measurement reporting, see 3GPP TS 45.008.

Instances of the PSI6 and PSI7 message may be broadcast on the PBCCH if non-GSM broadcast information is transmitted.

The PSI8 message may be broadcast on the PBCCH if additional information (i.e. CBCH configuration and dynamic ARFCN mapping) shall be provided to the mobile station camping on the cell.

The PSI11 message contains the PBCCH\_CHANGE\_MARK and PSI\_CHANGE\_FIELD parameters. The value of the PBCCH\_CHANGE\_MARK may be incremented by one, modulo 8, each time the network makes a change in the PBCCH information. Such change includes any addition, removal or replacement of PSI messages, contents of PSI messages, or change in the scheduling of PSI messages on PBCCH. A change in the contents of the PSI11 message alone shall not be reflected in the PBCCH\_CHANGE\_MARK. When the PBCCH\_CHANGE\_MARK is incremented, the PSI\_CHANGE\_FIELD parameter shall be set to an appropriate value to indicate the nature of the latest change in the PBCCH information.

The network may increment the PBCCH\_CHANGE\_MARK value by more than one, modulo 8, in order to enforce a complete acquisition of PBCCH information of all mobile stations.

In order to avoid extensive TBF suspensions following an increment of the PBCCH\_CHANGE\_MARK parameter, the network may send PSI messages on PACCH to mobile stations in packet transfer mode.

The network indicates the support of the PACKET PSI STATUS and EGPRS PACKET CHANNEL REQUEST messages in the PSI11 message.

#### 5.5.2.1.2 System information on BCCH

In addition to the requirements in 3GPP TS 44.018, a SYSTEM INFORMATION TYPE 13 (SI13) message is regularly broadcast by the network on the BCCH to support GPRS. Optionally and if PBCCH is not present in the cell, additional types of SI messages may be broadcast on BCCH. Some of them may be broadcast in multiple number of instances. If PBCCH is present in the cell, only the SI13 message is required on BCCH to support GPRS.

Based on this information, the GPRS mobile station is able to decide whether and how it gains access to the system via the current cell when PBCCH is not present.



The SI13 message contains the BCCH\_CHANGE\_MARK and SI\_CHANGE\_FIELD parameters. If PBCCH is not present in the cell, the value of the BCCH\_CHANGE\_MARK may be incremented by one, modulo 8, each time the network makes a change in the BCCH information. Such change includes any addition, removal or replacement of SI messages, contents of SI messages, or change in the scheduling of SI messages on BCCH. Changes in the contents of the SI13 message shall not be reflected in the BCCH\_CHANGE\_MARK. Changes of the contents of the RACH Control Parameters information element alone (see 3GPP TS 44.018) may optionally be reflected in the BCCH\_CHANGE\_MARK; if reflected, the SI\_CHANGE\_FIELD parameter may indicate only one of the SI message containing the RACH Control Parameters. When the BCCH\_CHANGE\_MARK is incremented, the SI\_CHANGE\_FIELD parameter shall be set to an appropriate value to indicate the nature of the latest change in the BCCH information.

When PBCCH is not present in the cell, the network may increment the BCCH\_CHANGE\_MARK value by more than one, modulo 8, in order to enforce a complete acquisition of BCCH information of all mobile stations.

If PBCCH is not present in the cell, instances of the SI 18 and SI 20 message may be broadcast on the BCCH if non-GSM broadcast information is transmitted.

The network indicates the support of the PACKET SI STATUS message in the SI13 message.

### 5.5.2.1.3 System information on PACCH (and other logical channels)

The network may broadcast PSI and SI messages on PACCH. In particular, if a mobile station is busy in packet transfer mode or MAC-Shared state and thus unable to receive the relevant blocks on the broadcast channels (PBCCH or BCCH) for a period longer than 15 seconds, the following requirements apply:

- If PBCCH is present in the cell, the network may broadcast the PSI1 message on PACCH such that the mobile station may receive the PSI1 message at least every 15 s.
- If PBCCH is not present in the cell, the network may broadcast the PSI13 message on PACCH such that the mobile station may receive the PSI13 messages at least every 15 s.

If the network has indicated the use of in-band signalling for a given MBMS radio bearer (with the MBMS In-band Signalling Indicator information element included in the MBMS ASSIGNMENT message in the serving cell and/or in the MBMS NEIGHBOURING CELL INFORMATION message in the old cell), it shall broadcast the full system information on PACCH of that MBMS radio bearer, as described in sub-clause 5.5.2.1.3b.

Furthermore, the network may broadcast PSI messages on PCCCH. In particular, the network may send the PSI1 and PSI13 messages on PCCCH to notify mobile stations in packet idle mode or MAC-Idle state about changes in the PBCCH information or changes of the PBCCH channel description.

If the network supports the PACKET PSI STATUS message and this message is received from a mobile station, the network may schedule the missing PSI messages for that mobile station on PACCH (sub-clause 5.5.1.4.3). Optionally, the missing PSI messages may be sent in one or more instances of the PACKET SERVING CELL DATA message for that mobile station on PACCH.

If the network supports the PACKET SI STATUS message and this message is received from a mobile station, the network may schedule the missing SI messages in one or more instances of the PACKET SERVING CELL DATA message for that mobile station on PACCH (sub-clause 5.5.1.4.3), or, in case the mobile station has indicated in the PACKET SI STATUS message that it supports the PACKET SERVING CELL SI message, the network should use the PACKET SERVING CELL SI messages instead of the PACKET SERVING CELL DATA messages.

If the network supports the SI2n message, it shall always use the PACKET SERVING CELL SI message when broadcasting the SI2n messages on PACCH.

NOTE: This is required due to the fact that the PACKET SERVING CELL SI is a distribution message making it possible for all mobile stations capable of decoding the SI2n message and listening to the PACCH to be able to receive the content.

The network may send the PSI14 message on PACCH to a mobile station in dual transfer mode or MAC-DTM state. The scheduling of the PSI14 message is determined by the network.

If PBCCH is present in the cell and the network changes the contents of any of the PSI messages, it shall set the PSI\_CHANGED\_IND to "1" in all the PSI14 messages it sends in the next 30 seconds. Otherwise, the PSI\_CHANGED\_IND shall be set to "0".

When a PSI or SI message is received on PACCH during dual transfer mode, no parameters except those relevant for monitoring possible changes in the contents of SI or PSI messages (e.g. PBCCH\_CHANGE\_MARK, BCCH\_CHANGE\_MARK, PSI\_CHANGED\_IND) shall be applied by the MS for operation in dual transfer mode.

The network may send neighbour cell PSI and SI messages on PACCH in one or more instances of the PACKET NEIGHBOUR CELL DATA message (see sub-clause 8.8.1).

#### 5.5.2.1.3a Rules for (P)SI distribution within Packet Serving Cell Data messages

In order to ensure a consistent distribution and decoding of (P)SI messages contained in PACKET SERVING CELL DATA messages, the following rules shall apply:

- Whenever the network starts sending a set of PACKET SERVING CELL DATA message instances in response to any PACKET (P)SI STATUS message, the first PACKET SERVING CELL DATA message instance shall be started with CONTAINER\_INDEX=0. If SI1 is broadcast in the serving cell and the MS has requested the SI1 message, the network shall include the SI1 message as the first SI message contained in the set of PACKET SERVING CELL DATA messages, starting from the message with CONTAINER\_INDEX=0. If the MS is able to decode the first SI message contained in the set of PACKET SERVING CELL DATA messages but it was not the SI1 message, the MS shall conclude that SI1 is not broadcast in the serving cell.
- All subsequent instances of a PACKET SERVING CELL DATA message set shall be sent in ascending order of CONTAINER\_INDEX value. It is allowed to send a PACKET SERVING CELL DATA message with the same CONTAINER\_INDEX value more than once.
- Whenever the MS receives a PACKET SERVING CELL DATA message instance with CONTAINER\_INDEX=0 or with a CONTAINER\_INDEX value that is less than the CONTAINER\_INDEX value of the last received PACKET SERVING CELL DATA message instance, it shall delete any PACKET SERVING CELL DATA message instances it may have stored but it shall keep the already extracted PSI/SI message instances.
- Whenever the MS leaves packet transfer mode, it shall delete any PACKET SERVING CELL DATA message instances it may have stored but it shall keep the already extracted PSI/SI message instances.

NOTE : In order to increase the probability that the MS receives the PACKET SERVING CELL DATA message instances (especially the one with CONTAINER\_INDEX =0), the network may poll the MS with a valid RRBP field in the RLC/MAC header of a PACKET SERVING CELL DATA message. Alternatively, the network may repeat the PACKET SERVING CELL DATA message instances one or more times.

#### 5.5.2.1.3b Rules for (P)SI distribution on PACCH of an MBMS radio bearer

If the network has indicated the use of in-band signalling for a given MBMS radio bearer, it shall broadcast on the PACCH the full system information provided on the (P)BCCH:

- In case PBCCH is allocated in the cell, the network shall broadcast the consistent set of PSI messages (it broadcasts on PBCCH), on the PACCH/D of the MBMS radio bearer.
- In case PBCCH is not allocated in the cell, the network shall broadcast the consistent set of SI messages (it broadcasts on the BCCH), on the PACCH/D of the MBMS radio bearer using PACKET SERVING CELL SI messages.

#### 5.5.2.1.4 Consistent sets of system information messages

Certain types of PSI and SI messages are sent on PBCCH and BCCH in a multiple number of instances. If such a PSI or SI message type is sent on (P)BCCH, the mobile station shall receive a consistent set of that type of PSI or SI message. In some cases, more than one type of PSI messages may be joined into one consistent set, see table 5.5.2.1.4.1.

Table 5.5.2.1.4.1: Consistent sets of system information messages

Consistent set / Message Type(s)	Broadcast Channel	Number of instances	PSI or SI change mark parameter	PSI or SI index parameter	PSI or SI count parameter
PSI2	PBCCH	1 - 8	PSI2_CHANGE_MARK (Note 3)	PSI2_INDEX	PSI2_COUNT
PSI3	PBCCH	1	PSI3_CHANGE_MARK		
PSI3 bis	PBCCH	1 - 16	PSI3_CHANGE_MARK	PSI3bis_INDEX	PSI3bis_COUNT
PSI3 ter	PBCCH	0 - 16	PSI3_CHANGE_MARK	PSI3ter_INDEX	PSI3ter_COUNT
PSI3 quater	PBCCH	0 - 16	PSI3_CHANGE_MARK	PSI3quater_INDEX	PSI3quater_COUNT
PSI5	PBCCH	0 - 8	PSI5_CHANGE_MARK	PSI5_INDEX	PSI5_COUNT
PSI6	PBCCH	0 - 8	PSI6_CHANGE_MARK	PSI6_INDEX	PSI6_COUNT
PSI7	PBCCH	0 - 8	PSI7_CHANGE_MARK	PSI7_INDEX	PSI7_COUNT
PSI8	PBCCH	0 - 8	PSI8_CHANGE_MARK	PSI8_INDEX	PSI8_COUNT
SI13 (Notes 1 and 2)	BCCH	1	SI13_CHANGE_MARK (Note 3)		
SI2 ter	BCCH	0 - 8	SI2ter_MP_CHANGE_MARK and SI2ter_3G_CHANGE_MARK	SI2ter_INDEX	SI2ter_COUNT
SI2 quater	BCCH	0 - 16	BA_IND, 3G_BA_IND and MP_CHANGE_MARK	SI2quater_INDEX	SI2quater_COUNT
SI2n	BCCH	0 - 16	SI2n_CHANGE_MARK	SI2n_INDEX	SI2n_COUNT
SI15	BCCH	0 - 4	DM_CHANGE_MARK	SI15_INDEX	SI15_COUNT
SI18	BCCH	0 - 8	SI18_CHANGE_MARK	SI18_INDEX	None (Note 4)
SI19	BCCH	0 - 8	SI19_CHANGE_MARK	SI19_INDEX	None (Note 4)
SI20	BCCH	0 - 8	SI20_CHANGE_MARK	SI20_INDEX	None (Note 4)
SI21	BCCH	0 - 8	SI21_CHANGE_MARK	SI21_INDEX	SI21_COUNT
SI22	BCCH	0 - 8	SI22_CHANGE_MARK	SI22_INDEX	SI22_COUNT
SI23	BCCH	0 - 8	SI23_CHANGE_MARK	SI23_INDEX	SI23_COUNT
<p>NOTE 1: If the SI13 message provides a GPRS mobile allocation, it shall also provide an SI13_CHANGE_MARK. The SI13_CHANGE_MARK shall be used if the indirect encoding of the frequency information is applied in a packet assignment, referring to the GPRS mobile allocation provided in the SI13 message. There is only one instance of the SI13 message.</p> <p>NOTE 2: The PSI13 message may be received on PACCH. It provides the same information as SI13, including the SI13_CHANGE_MARK.</p> <p>NOTE 3: If PSI2 and SI13 <i>change mark</i> values need to be distinguished, e.g. during an activation or release of PBCCH, the network should assign appropriate values to these parameters.</p> <p>NOTE 4: For SI18, SI19 and SI20 messages, there is no <i>count</i> parameter (see 3GPP TS 44.018).</p>					

A consistent set of system information messages is identified by a PSI or SI *change mark* parameter included in each message in the set. All messages within a consistent set shall have the same value of this parameter.

The total number of system information messages of a certain type within a consistent set is indicated by a PSI or SI *count* parameter included in each message in the set. The position of a certain message instance within the consistent set of system information messages is indicated by a PSI or SI *index* parameter.

The PSI or SI *count* parameter shall have the value N-1, where N is the number of instances of the particular message type present in the consistent set. The PSI or SI *index* parameter shall have a range from zero to N-1. Different instances of a particular message type in a consistent set shall have different values of the PSI or SI *index* parameter.

## 5.5.2.2 Paging

The network is required to send valid RLC data blocks or RLC/MAC control blocks continuously on all subchannels on PCCCH where paging can appear.

NOTE: If RLC data blocks are sent in the blocks on PCCCH where paging may appear, the network uses the coding schemes CS-1 to CS-4, in order to avoid the expiry of the downlink signalling counter for non-EGPRS capable mobile stations (see 3GPP TS 45.002).

### 5.5.2.3 Network Assisted Cell Change

A cell that supports GPRS (in *A/Gb mode*) and/or *Iu mode* shall indicate if CCN is enabled. This shall be indicated on BCCH and on PBCCH in the parameter CCN\_ACTIVE (see sub-clause 12.24). The network may also send a PACKET MEASUREMENT ORDER message with the parameter CCN\_ACTIVE set to order an individual mobile station to apply the CCN procedures in the serving cell or a PACKET CELL CHANGE ORDER or a PS HANDOVER COMMAND message to order an individual mobile station to apply the CCN procedures in the new cell. This parameter controls the overall enabling of CCN. The network may also indicate in system information messages sent on BCCH and PBCCH and individually in the PACKET MEASUREMENT ORDER or PACKET CELL CHANGE ORDER or PS HANDOVER COMMAND messages whether CCN mode shall be entered towards a particular cell (see sub-clause 8.8.2). A GSM cell that supports PS handover to *GAN mode* shall ensure that CCN is enabled for all GAN neighbour cells.

The network may also send neighbour cell system information on PACCH to be used by the mobile station at initial access after cell re-selection (see sub-clause 8.8.1).

When the network receives a PACKET CELL CHANGE NOTIFICATION message from the mobile station, the network may respond by sending neighbour cell system information for the proposed cell or another cell and also complete the transmission of ongoing data packets before sending a PACKET CELL CHANGE CONTINUE message (to confirm the proposed cell) or a PACKET CELL CHANGE ORDER message. The neighbour cell information is sent in PACKET NEIGHBOUR CELL DATA messages.

The ARFCN for BCCH and the BSIC identifying a GSM neighbour cell shall be included in the PACKET CELL CHANGE CONTINUE message in case a set of PACKET NEIGHBOUR CELL DATA messages referred by the corresponding CONTAINER\_ID value was sent for that cell without ARFCN and BSIC provided. If included by the network in the PACKET CELL CHANGE CONTINUE message, ARFCN and BSIC shall reflect the cell proposed in the PACKET CELL CHANGE NOTIFICATION message. Upon reception of the PACKET CELL CHANGE CONTINUE message the mobile station shall continue the cell reselection in NC0/NC1 mode irrespective of the cell indicated in the ARFCN and BSIC parameters.

### 5.5.2.4 Packet Switched Handover

Packet switched handover is applicable only in packet transfer mode.

If the network supports PS handover it may initiate the PS handover procedure for a mobile station that supports PS handover as a result of various trigger conditions such as, but not restricted to, the following:

- Upon reception of a PACKET CELL CHANGE NOTIFICATION message from a mobile station operating in NC0.
- Upon reception of a PACKET CELL CHANGE NOTIFICATION message or measurement reports from a mobile station operating in NC1.
- Upon reception of measurement reports from a mobile station operating in NC2.
- Upon determining that resource limitations exist for the serving cell.
- Upon receiving the *Service UTRAN CCO* IE from the SGSN indicating that a mobile station operating in *A/Gb mode* would be better served in a cell supporting a different RAT.

For PS handover to a GSM neighbour cell the NC mode applicable to the new cell shall be indicated by the PS HANDOVER COMMAND message sent to the mobile station in the old cell.

## 5.6 Measurement reports

### 5.6.0 General

The network may request measurement reports from the MS. The measurement reporting principles are specified in 3GPP TS 45.008. The measurement reports consists of

- Network Control (NC) measurement reports sent when the MS is in *A/Gb mode* and GMM Ready state (see 3GPP TS 24.008) or the MS is in *Iu mode* and in RRC-Cell\_Shared state; this may be performed with either the

PACKET MEASUREMENT REPORT message or the PACKET ENHANCED MEASUREMENT REPORT message.

## 5.6.1 Network Control (NC) measurement reporting

The behaviour of the mobile station is controlled by the parameter NETWORK\_CONTROL\_ORDER broadcast in the PSI5 message on PBCCH, in the SI13 and SI2quater messages on the BCCH and in the PSI13 message on PACCH. Alternatively, the network may send the NETWORK\_CONTROL\_ORDER parameters in a PACKET MEASUREMENT ORDER or in a PACKET CELL CHANGE ORDER message on PCCCH or PACCH to a particular mobile station or in a PS HANDOVER COMMAND message sent on PACCH to a particular mobile station. The parameter NETWORK\_CONTROL\_ORDER may have one of the values NC0, NC1, NC2 or RESET, see 3GPP TS 45.008.

When in mode NC1 or NC2, the mobile station shall perform the NC measurements as defined in 3GPP TS 45.008. The reporting periods are indicated in the NC\_REPORTING\_PERIOD\_I and NC\_REPORTING\_PERIOD\_T field of the PSI5, the SI2quater, the PACKET CELL CHANGE ORDER or the PACKET MEASUREMENT ORDER message. If NC\_NON\_DRX\_PERIOD, NC\_REPORTING\_PERIOD\_I or NC\_REPORTING\_PERIOD\_T have not been received by the mobile station the default values shall be used. The mobile station shall apply to the timer T3158 either the NC\_REPORTING\_PERIOD\_I when in packet idle mode or the NC\_REPORTING\_PERIOD\_T when in packet transfer mode. The measurement results shall be sent to the network using the procedures specified in sub-clause 7.3 for packet idle mode, and in sub-clause 8.3 for packet transfer mode.

On expiry of timer T3158, the mobile station shall restart timer T3158 with the indicated reporting period, perform the measurements and send either the PACKET MEASUREMENT REPORT message or the PACKET ENHANCED MEASUREMENT REPORT to the network. The condition for sending the PACKET ENHANCED MEASUREMENT REPORT message instead of the PACKET MEASUREMENT REPORT message is based on the REPORT\_TYPE parameter and if the MS has received BSIC information for all cells. For the detailed conditions see sub-clauses 11.2.23, 11.2.4 and 11.2.9b and also 3GPP TS 44.018 sub-clause 10.5.2.33b. A mobile station in packet idle mode (respectively packet transfer mode) in NC2 may transmit a PACKET CELL CHANGE NOTIFICATION message, instead of a PACKET MEASUREMENT REPORT message or PACKET ENHANCED MEASUREMENT REPORT message, if the conditions in sub-clause 5.6.3.9 are met, A mobile station shall send no more than one PACKET CELL CHANGE NOTIFICATION per  $([4] \times \text{NC\_REPORTING\_PERIOD\_I})$  seconds (respectively  $([4] \times \text{NC\_REPORTING\_PERIOD\_T})$  seconds).

A mobile station in mode NC1 or NC2 may receive a new indicated reporting period while timer T3158 is active. If the new indicated reporting period is less than the time to expiry of timer T3158, the mobile station shall immediately restart timer T3158 with the new indicated reporting period. Otherwise, the timer T3158 shall continue to run.

When changing from packet transfer mode to packet idle mode, a mobile station in mode NC1 or NC2 shall restart the timer T3158 with the reporting period determined by the NC\_REPORTING\_PERIOD\_I parameter if at least one PACKET MEASUREMENT REPORT or PACKET ENHANCED MEASUREMENT REPORT message was sent in packet transfer mode. Otherwise the timer T3158 shall continue to run.

When changing from packet idle mode to packet transfer mode, a mobile station in mode NC1 or NC2 shall restart the timer T3158 with the reporting period determined by the NC\_REPORTING\_PERIOD\_T parameter if the reporting period is less than the time to expiry of timer T3158. Otherwise the timer T3158 shall continue to run.

When a mobile station leaves the GMM Ready state, the timer T3158 shall be stopped and no more measurement reports shall be sent to the network.

A mobile station may reselect a new cell or may be ordered to reselect a new cell with mode NC1 or NC2 while timer T3158 is active. If time to expiry of timer T3158 is greater than the indicated reporting period for the new cell, the mobile station shall immediately restart timer T3158 with the indicated reporting period for the new cell. Otherwise, the timer T3158 shall continue to run.

At cell reselection the NC measurement parameters valid for the mobile station in the new cell (NETWORK\_CONTROL\_ORDER, NC\_NON\_DRX\_PERIOD, NC\_REPORTING\_PERIOD\_I and NC\_REPORTING\_PERIOD\_T) are either:

- brought from the old cell if received in a PACKET CELL CHANGE ORDER message sent in the old cell; or
- received in a broadcast PSI5, SI13, PSI13 or SI2quater message in the new cell. If no parameters have been brought from the old cell, and until individual measurement parameters are received in the new cell, the mobile

station shall use the broadcast measurement parameters from PSI5 if a PBCCH is allocated in the cell or SI2quater if a PBCCH is not allocated in the cell or use the default parameter values.

The default frequency list to be applied in the new cell following a cell reselection or the successful completion of the PS handover procedure shall be the BA(GPRS) list of that cell until a new PACKET MEASUREMENT ORDER message is received. For the case of cell reselection the BA(GPRS) list could also have been modified by frequency parameters received in a PACKET CELL CHANGE ORDER message in the old cell.

For (NC) measurements reporting, the Mobile Station shall use PACKET ENHANCED MEASUREMENT REPORT messages instead of PACKET MEASUREMENT REPORT messages if that is indicated by the parameter REPORT\_TYPE and if at least one BSIC is allocated to each frequency in the BA(GPRS) list.

For a mobile station supporting UTRAN, reports on 3G cells may also be included in the reporting. For a mobile station supporting "E-UTRAN Neighbour Cell measurements and MS autonomous cell reselection to E-UTRAN", reports on E-UTRAN cells may also be included in the reporting. For report with the PACKET MEASUREMENT REPORT message, reporting is performed on three separate lists: the BA(GPRS), the 3G Neighbour Cell List (for a multi-RAT MS supporting UTRAN) and the E-UTRAN Neighbour Cell List (for a MS supporting "E-UTRAN Neighbour Cell measurements and MS autonomous cell reselection to E-UTRAN"). For report with the PACKET ENHANCED MEASUREMENT REPORT message, reporting is performed on the Neighbour Cell List (defined in sub-clause 5.6.3.3) and the E-UTRAN Neighbour Cell List (for a multi-RAT MS supporting "E-UTRAN Neighbour Cell measurements and MS autonomous cell reselection to E-UTRAN").

A multi-RAT MS supporting UTRAN and/or E-UTRAN with no CSG Whitelist or an empty CSG Whitelist shall not send any measurement reports for cells that are known to be UTRAN/E-UTRAN CSG cells. A multi-RAT MS supporting UTRAN and/or E-UTRAN which is a member of at least one Closed Subscriber Group (i.e. at least one CSG ID is included in its CSG Whitelist) but does not support CSG Cells Reporting shall not send any measurement reports for cells that are known to be UTRAN/E-UTRAN CSG cells other than in a PACKET CELL CHANGE NOTIFICATION message for a CSG cell which is the proposed target cell (see sub-clause 8.8.3).

The reporting of CSG cells and hybrid cells is specified in sub-clause 5.6.3.9.

A mobile station involved in an RR connection (in class A mode of operation), shall not send Network Control measurement reports to the network during that period. The mobile station shall return to the previous reporting mode when the RR connection is released.

## 5.6.2 (void)

## 5.6.3 Additional measurement and reporting parameters

Some parameters from the PACKET MEASUREMENT ORDER, PACKET CELL CHANGE ORDER, SI2quater, SI23, PSI3bis, PSI3ter, PSI3quater or PSI5 messages allow to build GPRS Measurement Parameters, GPRS 3G Measurement Parameters, GPRS E-UTRAN Measurement Parameters and neighbour cell lists which are used for Network Control (NC) measurement reporting.

### 5.6.3.1 Deriving the 3G Neighbour Cell list from the 3G Neighbour Cell description

In a cell without a PBCCH allocated, the 3G Neighbour Cell list is given by one or more instances of the SI2quater message with the same 3G\_BA\_IND value. If the SI23 message is broadcast in the cell, for a UTRAN capable mobile station supporting network sharing the 3G neighbour Cell list is given by one or more instances of the PACKET MEASUREMENT ORDER message with the same 3G\_BA\_IND value.

In a cell with a PBCCH allocated, the 3G Neighbour Cell list is given by one or more instances of the PSI3quater message with the same PSI3\_CHANGE\_MARK value.

The 3G Neighbour cell list may be modified by a PACKET CELL CHANGE ORDER message (in which case the reference list is given on the new cell) or by one or more instances of the PACKET MEASUREMENT ORDER message with the same 3G\_BA\_IND value as in the SI2quater message or PSI3\_CHANGE\_MARK value as in the PSI3quater message. A UTRAN capable mobile station supporting network sharing shall build its 3G Neighbour Cell list from the information received in the PACKET CELL CHANGE ORDER message (in which case the 3G Neighbour Cell list is only used in the new cell if the SI23 message is broadcast in the new cell).

The 3G Neighbour Cell list may contain up to 96 3G Neighbour Cells and/or UTRAN frequencies for RSSI reporting.

Each *3G Neighbour Cell Description* received is added to the 3G Neighbour Cell list, starting with the index equal to the parameter `Index_Start_3G`. If this parameter is not present then the value 0 shall be used.

For each *3G Neighbour Cell Description* received, the cells / UTRAN frequencies are indexed in the following order:

- 1: UTRAN FDD cells / UTRAN FDD frequencies: FDD UARFCNs are indexed in the order of occurrence in the 3G Neighbour Cell description. For each FDD UARFCN indicating UTRAN FDD cells, the cells are indexed in the order of increasing values of the decoded `FDD_CELL_INFORMATION` parameters.
- 2: UTRAN TDD cells / UTRAN TDD frequencies: TDD UARFCNs are indexed in the order of occurrence in the 3G Neighbour Cell description. For each TDD UARFCN indicating UTRAN TDD cells, the cells are indexed in the order of increasing values of the decoded `TDD_CELL_INFORMATION` parameters.

If more than one cell / UTRAN frequency with the same index in the 3G Neighbour Cell list are provided by different instances of 3G Neighbour Cell descriptions, the cell / UTRAN frequency from the message instance with the highest index shall be used. In case the same 3G Cell / UTRAN frequency occurs more than once in the resulting 3G Neighbour Cell list, each occurrence shall be assigned an index but only the cell / UTRAN frequency with the highest index in the 3G Neighbour Cell list shall be referred to in measurement reports.

The *3G Neighbour Cell Description* may contain information on 3G Neighbour Cells / UTRAN frequencies to be removed (*REMOVED\_3GCELL\_Description*). The cells / UTRAN frequencies to be removed are identified by their indices in the 3G Neighbour Cell list. Removed cells / UTRAN frequencies shall keep their indices but no measurement shall be performed. If the index is higher than 95 or points to a 3G cell / UTRAN frequency that does not exist, this shall not be considered as an error.

In a cell without PBCCH allocated, the mobile station shall only combine 3G Neighbour cells / UTRAN frequencies from SI2quater (or PACKET MEASUREMENT ORDER, if the SI23 message is broadcast) message instances indicating the same value of the `3G_BA_IND` without any message instance indicating a different value of the `3G_BA_IND` received in between.

In a cell with a PBCCH allocated, the mobile station shall only combine 3G Neighbour cells / UTRAN frequencies from PSI3quater messages indicating the same `PSI3_CHANGE_MARK` value.

If a 3G Neighbour Cell Description includes non-supported frequencies or Radio Access Technologies or if the same cell / UTRAN frequency occurs more than once, this shall not be considered as an error; indices in the 3G neighbour Cell list shall be incremented accordingly. If a cell / UTRAN frequency is provided for an index higher than 95 in the 3G Neighbour Cell list, this shall not be considered as an error; the cell / UTRAN frequency shall not be included in the 3G Neighbour Cell list.

For a mobile station indicating support for UTRA Multiple Frequency Band Indicators (MFBI) in the MS Radio Access Capabilities IE (see 3GPP TS 24.008), the network may send different FDD ARFCN values corresponding to different frequency bands but designating the same physical UTRAN frequency in the PACKET CELL CHANGE ORDER message or in the PACKET MEASUREMENT ORDER message. The network may also broadcast different FDD ARFCN values corresponding to different frequency bands but designating the same physical UTRAN frequency in the SI2quater message; in such a case, a mobile station supporting UTRA Multiple Frequency Band Indicators (MFBI) shall consider a FDD ARFCN value belonging to frequency band it does not support as a non-supported frequency. When a PACKET CELL CHANGE ORDER message or a PACKET MEASUREMENT ORDER message or a SI2quater message is received by the MFBI capable MS, each occurrence of a FDD ARFCN corresponding to different frequency bands but designating the same physical UTRAN frequency shall be assigned an index in the 3G Neighbour Cell list. However, only the highest index in the list that corresponds to a supported frequency band shall be referred to in measurement reports.

The MS behaviour is not specified if the number of 3G frequencies or cells exceeds the MS monitoring capabilities as defined in 3GPP TS 45.008.

#### 5.6.3.1a Deriving the E-UTRAN Neighbour Cell list from the Repeated E-UTRAN Neighbour Cell information

The E-UTRAN Neighbour Cell list is given by one or more instances of the SI2quater message with the same `3G_BA_IND` value, or alternatively, if the SI23 message is broadcast in the cell and for a mobile station supporting network sharing, by one or more instances of the SI23 message with the same `SI_23_BA_IND` value, see 3GPP TS 44.018.

If the mobile station receives a full set of instances of the PACKET MEASUREMENT ORDER message (see sub-clause 11.2.9b) with the same 3G\_BA\_IND value as in the SI2quarter message, each *E-UTRAN Parameters Description* IE received therein shall be used to modify the E-UTRAN Neighbour Cell list received from SI2quarter. When a mobile station supporting network sharing builds its E-UTRAN Neighbour Cell list from the information received in the SI23 message, this list shall only be modified if the mobile station receives a full set of instances of the PACKET MEASUREMENT ORDER message with the same 3G\_BA\_IND value as the SI 23\_BA\_IND value in the SI23 message, in which case each *E-UTRAN Parameters Description* IE received therein shall be used to modify the E-UTRAN Neighbour Cell list received from SI23.

The E-UTRAN Neighbour Cell list may contain up to 8 E-UTRAN frequencies. Each frequency described by a *Repeated E-UTRAN Neighbour Cell* IE is added to the E-UTRAN Neighbour Cell list in the order in which they appear in the message. Different instances of the *Repeated E-UTRAN Neighbour Cells* IE shall be evaluated in ascending order of the PMO\_INDEX of the PACKET MEASUREMENT ORDER message that they are received in.

In case the same E-UTRAN frequency occurs more than once in the resulting E-UTRAN Neighbour Cell list, each occurrence shall be assigned an index but only the E-UTRAN frequency with the highest index in the E-UTRAN Neighbour Cell list shall be referred to in measurement reports.

For a mobile station indicating support for E-UTRA Multiple Frequency Band Indicators (MFBI) in the MS Radio Access Capabilities IE (see 3GPP TS 24.008), the network may send different EARFCN values corresponding to different frequency bands but designating the same physical E-UTRAN frequency in the PACKET MEASUREMENT ORDER message. The network may also broadcast different EARFCN values corresponding to different frequency bands but designating the same physical E-UTRAN frequency in the SI2quarter message or SI23 message; in such a case, a mobile station supporting E-UTRA Multiple Frequency Band Indicators (MFBI) shall consider an EARFCN value belonging to frequency band it does not support as a non-supported frequency. When a PACKET MEASUREMENT ORDER message or a SI2quarter message or a SI23 message is received by the MFBI capable MS, each occurrence of an EARFCN corresponding to different frequency bands but designating the same physical E-UTRAN frequency shall be assigned an index in the E-UTRAN Neighbour Cell list. However, only the highest index in the list that corresponds to a supported frequency band shall be referred to in measurement reports.

The mobile station behaviour is not specified if the number of E-UTRAN frequencies exceeds the MS monitoring capabilities as defined in 3GPP TS 45.008.

NOTE 1: Multiple instances of a PACKET MEASUREMENT ORDER message may be received as described in sub-clause 11.2.9b.

### 5.6.3.2 Deriving BA(GPRS) and the GSM Neighbour Cell list

In a cell without a PBCCH allocated, BA(GPRS) is equal to the BA (list) from the SI2/SI2bis/SI2ter messages. BSICs from the GPRS BSIC Description from one or more instances of the SI2quarter message (if broadcast) shall be associated with BA(GPRS) with the same BA\_IND value to create the GSM Neighbour Cell list, as described in 3GPP TS 44.018 (sub-clause 3.4.1.2.1.2). When the mobile station has acquired the GSM Neighbour Cell list, the mobile station shall include in the measurement reports only cells present in that list. If GPRS BSIC Description is not broadcast, the GSM Neighbour Cell list is equal to BA(GPRS) (only a frequency list).

In a cell with a PBCCH allocated, BA(GPRS) is derived from the neighbour cell parameters sent in PSI3 and ascending order of PSI3bis on PBCCH with the same PSI3\_CHANGE\_MARK value (see sub-clause 11.2.20). Each neighbour cell listed in PSI3 and in one or more instances of PSI3bis is assigned an ascending index used for measurement reports. The first neighbour cell in PSI3 has the lowest index (= 0), and the last neighbour cell in the highest indexed PSI3bis message has the highest index. The GSM Neighbour Cell list is equal to BA(GPRS).

The GSM Neighbour Cell list may contain up to 96 GSM Neighbour Cells. The total number of frequencies to measure shall not exceed 32. If the list includes more than 32 frequencies, the MS shall only measure the 32 frequencies with the lowest indices.

The GSM Neighbour Cell list may be modified by "NC Frequency List" in a PACKET CELL CHANGE ORDER message (in which case the reference list is given on the new cell) or one or more instances of the PACKET MEASUREMENT ORDER message with the same BA\_IND value or PSI3\_CHANGE\_MARK value.

The "NC Frequency List" may add cells to the GSM Neighbour Cell list (see sub-clauses 11.2.4 and 11.2.9b). These cells shall be added at the end of the GSM Neighbour Cell list and indexed in the order of occurrence within the PACKET CELL CHANGE ORDER message or ascending instances of the PACKET MEASUREMENT ORDER



message. The list of added cells may contain GPRS and optionally *Iu mode* cell re-selection parameters. The "NC Frequency List" does not impact the serving cell parameters.

The "NC *Iu Mode Only Capable Cell List*" may add cells to the GSM Neighbour Cell list (see sub-clauses 11.2.4 and 11.2.9b). These *Iu mode* only capable cells shall be added at the end of the GSM Neighbour Cell list after *A/Gb mode* or both *A/Gb* and *Iu mode* capable cells and indexed in the order of occurrence within the PACKET CELL CHANGE ORDER message or ascending instances of the PACKET MEASUREMENT ORDER message. The list of added cells may contain *Iu mode* only cell re-selection parameters.

In case the same cell (ARFCN+BSIC) or the same ARFCN without BSIC occur more than once in the resulting GSM Neighbour Cell list, each occurrence shall be assigned an index but only the cell with the highest index shall be used for cell re-selection and referred to in measurement reports.

The "NC Frequency List" may delete frequencies from the BA(GPRS) list (see sub-clause 11.2.9b). The frequencies to be removed are identified by their indices in the BA(GPRS). In this case all cells associated with the removed frequencies shall be removed from the GSM Neighbour Cell list. Removed cells/frequencies shall keep their indices but no measurements or reporting shall be performed. If the index points to a cell that does not exist, this shall not be considered as an error.

If the mobile station receives a PACKET MEASUREMENT ORDER message (full set of instances) with changed PMO\_IND parameter value, any old "NC frequency list" shall be deleted. If the last PACKET MEASUREMENT ORDER message (full set of instances) does not contain a "NC frequency list" (no added or deleted frequencies) the mobile station shall return to BA(GPRS).

In a cell without PBCCH allocated, if the BA\_IND parameter is changed, the mobile station shall re-read and rebuild the GSM Neighbour Cell list.

In a cell with a PBCCH allocated, if PSI3\_CHANGE\_MARK is changed, the mobile station shall re-read and rebuild the GSM Neighbour Cell list.

### 5.6.3.3 Deriving the Neighbour Cell list from the GSM Neighbour Cell list and the 3G Neighbour Cell list

The Neighbour Cell list may contain up to 96 Neighbour Cells. For report with the PACKET ENHANCED MEASUREMENT REPORT message, the Neighbour Cell list is the concatenation of the GSM Neighbour Cell list and the 3G Neighbour Cell list (if any). In this concatenation the value of the parameter Absolute\_Index\_Start\_EMER is added to the 3G Neighbour Cell list indices. If the same index occurs for a GSM Cell and a 3G Cell, the GSM Cell shall be used.

NOTE: For report with the PACKET MEASUREMENT REPORT message, the concatenated list is not used. Instead, the two lists are used separately, as defined in table 11.2.9.2 from sub-clause 11.2.9.

### 5.6.3.4 GPRS Real Time Differences

The GPRS Real Time Difference list may contain up to 96 Real Time Difference parameters.

In a cell without PBCCH allocated, GPRS Real Time Difference information may be received from the SI2quater message and associated with the BA (list) from the SI2/SI2bis/SI2ter messages with the same BA\_IND value, see 3GPP TS 44.018. Each frequency in the BA (list) may be associated to 0, 1 or more Real Time Difference parameters. The Real Time Difference parameters may be received before the corresponding BA (list). The parameter BA\_Index\_Start\_RTD in each structure indicates the index of the frequency in the BA (list) to be taken as a starting reference. A sub-structure is included for each frequency referenced. Each of those sub-structures indicates if 0, 1 or more RTD parameters are present for this frequency. If a frequency in the BA (list) is not provided with Real Time Difference information by any of the message instances with correct BA\_IND value, it shall be assumed that no information is available for that frequency. If the MP\_CHANGE\_MARK parameter is changed, the mobile station shall re-read the Real Time Difference parameters.

In a cell with a PBCCH allocated, GPRS Real Time Difference information may be received from the PSI3ter messages and associated with the GSM Neighbour Cell list with the same PSI3\_CHANGE\_MARK value. In this case each cell may be associated to 0 or 1 Real Time Difference parameter. The Real Time Difference parameters may be received before the corresponding GSM Neighbour Cell list. The parameter Cell\_Index\_Start\_RTD in each structure indicates the index of the cell in the GSM Neighbour Cell list to be taken as a starting reference. A sub-structure is included for each GSM Neighbour Cell referenced. Each of those sub-structures indicate if 0 or 1 RTD parameter is present for this GSM Neighbour Cell. If a cell in the GSM Neighbour Cell list is not provided with Real Time Difference information by any of the message instances with correct PSI3\_CHANGE\_MARK value, it shall be assumed that no information is available for that cell. If some Real Time Difference information are provided for a cell that does not exist, this shall not be considered as an error. See sub-clause 11.2.21.

### 5.6.3.5 GPRS Report Priority Descriptions

In a cell without PBCCH allocated, Report Priority information may be received from the SYSTEM INFORMATION TYPE 2 QUATER message and associated to the Neighbour Cell list with the same BA\_IND value and 3G\_BA\_IND value, see 3GPP TS 44.018. If the parameter MP\_CHANGE\_MARK is changed, the mobile shall re-read the GPRS Report Priority information. Each REP\_PRIORITY bit of this field relates to indices of the Neighbour Cell list starting with index 0.

In a cell with a PBCCH allocated, Report Priority information for GSM cells may be received from the PACKET SYSTEM INFORMATION TYPE 3 TER message and associated to the GSM Neighbour Cell list with the same PSI3\_CHANGE\_MARK value, see sub-clause 11.2.21a. Each REP\_PRIORITY bit of this field relates to indices of the GSM Neighbour Cell list starting with index 0.

In a cell with a PBCCH allocated, Report Priority information for 3G cells may be received from the PACKET SYSTEM INFORMATION TYPE 3 QUATER message and associated to the 3G Neighbour Cell list with the same PSI3\_CHANGE\_MARK value, see sub-clause 11.2.21b. Each REP\_PRIORITY bit of this field relates to indices of the 3G Neighbour Cell list starting with index 0.

If Report Priority information is received as part of a PACKET MEASUREMENT ORDER or PACKET CELL CHANGE ORDER message, it is associated to the Neighbour Cell list and may be received before the corresponding Neighbour Cell list. Each REP\_PRIORITY bit of this field relates to indices of the Neighbour cell list, starting with index 0.

Indices exceeding the value 95 shall be ignored. If there are fewer indices than the number of Neighbour Cells, the value 0 shall be assumed for the missing bits.

### 5.6.3.6 GPRS Measurement Parameters and GPRS 3G Measurement Parameters

In a cell without a PBCCH allocated, GPRS Measurement Parameters, GPRS 3G Measurement Parameters and 3G Priority Parameters may be received from SI2quater message, see 3GPP TS 44.018. When the parameter MP\_CHANGE\_MARK is changed, the mobile station shall re-read GPRS Measurement Parameters and GPRS 3G Measurement Parameters and 3G Priority Parameters.

In a cell with a PBCCH allocated, GPRS Measurement Parameters and GPRS 3G Measurement Parameters may be received from PSI3quater and PSI5 messages, see sub-clauses 11.2.21b and 11.2.23. Additionally, 3G Priority Parameters may also be received from PSI3quater messages. When the PSI5\_CHANGE\_MARK parameter is changed, the MS shall re-read the corresponding Measurement Parameters and 3G Measurement Parameters. When the PSI3\_CHANGE\_MARK parameter is changed, the MS shall re-read the corresponding Measurement Parameters, 3G Priority Parameters and 3G Measurement Parameters.

If different values are received for the same parameter in different instances of a message, only the value in the instance with the highest index shall be used.

#### 5.6.3.6a GPRS E-UTRAN Measurement Parameters

This sub-clause applies only to an E-UTRAN capable mobile station.

GPRS E-UTRAN Measurement Parameters may be received from SI2quater message, see 3GPP TS 44.018.

GPRS E-UTRAN Measurement Parameters may be modified by one or more instances of the PACKET MEASUREMENT ORDER message with the same 3G\_BA\_IND value as the SI2quater message.

If different values are received for the same parameter in different instances of the PACKET MEASUREMENT ORDER message, only the value in the instance with the highest index shall be used.

### 5.6.3.7 The GPRS 3G Cell Reselection list

This sub-clause applies only to a (3G) multi-RAT MS.

In a cell without a PBCCH allocated, the GPRS 3G Cell Reselection list is equal to the 3G Cell Reselection list that is defined in 3GPP TS 44.018.

In a cell with a PBCCH allocated, the GPRS 3G Cell Reselection list is the union of 3G Cells and/or 3G frequencies provided in one or more instances of the PSI3quarter message. The GPRS 3G Cell Reselection list may contain up to 96 3G Cells. 3G Cells not provided explicitly in the PSI3quarter message (frequencies on their own) are not included in these 96 cells. Up to 8 frequencies on their own can be added to these 96 cells.

The MS behaviour is not specified if the number of 3G frequencies or cells exceeds the MS monitoring capabilities as defined in 3GPP TS 45.008.

When the 3G Neighbour Cell list is modified by a PACKET CELL CHANGE ORDER message or by one or more instances of the PACKET MEASUREMENT ORDER message with the same 3G\_BA\_IND value as in the SI2quarter message, the GPRS 3G Cell Reselection list shall be updated according to the modified 3G Neighbour Cell list. A UTRAN capable mobile station supporting network sharing shall build its 3G Cell Reselection list from the information received in the PACKET CELL CHANGE ORDER message (in which case the 3G Cell Reselection list is only used in the new cell if the SI23 message is broadcast in the new cell). If SI23 is broadcast in the cell and for a mobile station supporting network sharing, the 3G Cell Reselection list shall only be modified by one or more instances of the PACKET MEASUREMENT ORDER message with the same 3G\_BA\_IND value as the SI 23\_BA\_IND value broadcast in the SI23 message.

NOTE: Frequencies for which the parameter NR\_OF\_FDD\_CELLS is set to 0 (and FDD\_Indic0 is set to 0) or NR\_OF\_TDD\_CELLS is set to 0 (and TDD\_Indic0 is set to 0) are not added to the GPRS 3G Cell Reselection list. They are added to the 3G Neighbour Cell list and are only used for RSSI reporting (subject to the restrictions given in 3GPP TS 45.008). Frequencies for which NR\_OF\_FDD\_CELLS is set to a value from 17 to 31 or NR\_OF\_TDD\_CELLS is set to a value from 21 to 31 are not added to the 3G Cell Reselection list (see sub-clause 11.2.9b).

#### 5.6.3.7a (void)

#### 5.6.3.7b The 3G Frequency list

The 3G Frequency list consists of the set of UTRAN frequencies contained in the GPRS 3G Cell Reselection list or in the 3G Neighbour Cell list, depending on which list is being used by the mobile station. The 3G Frequency list is constructed as specified in 3GPP TS 44.018.

When the 3G Neighbour cell list is modified (e.g. by a PACKET CELL CHANGE ORDER message or by one or more instances of the PACKET MEASUREMENT ORDER message), the 3G Frequency list shall be updated.

### 5.6.3.8 Closed Subscriber Group Information

This applies only to a multi-RAT MS supporting UTRAN and/or E-UTRAN. One or more instances of the SI2quarter or the PACKET MEASUREMENT ORDER message may provide the *E-UTRAN CSG Description* IE and/or the *3G CSG Description* IE. An MS supporting cell reselection to UTRAN and/or E-UTRAN shall use this information as described in 3GPP TS 45.008.

If an MS receives a *CSG\_PSC\_SPLIT* IE and/or a *CSG\_PCI\_SPLIT* IE it shall store this information and shall consider it as being valid for the specified frequencies for a period of up to 24 hours or until a new *CSG\_PSC\_SPLIT* IE and/or a new *CSG\_PCI\_SPLIT* IE is received, whichever occurs first.

Any valid "CSG PSC Split Information" received from a UTRAN frequency and stored by the mobile station shall take precedence over the information received from the *CSG\_PSC\_SPLIT* IE for that frequency. Any valid "CSG PCI Split Information" received from an E-UTRAN frequency and stored by the mobile station shall take precedence over the information received from the *CSG\_PCI\_SPLIT* IE for that frequency.

### 5.6.3.9 Reporting of CSG Cells and Hybrid Cells

A multi-RAT mobile station in packet transfer mode may report a CSG cell or a detected hybrid cell in a PACKET MEASUREMENT REPORT or PACKET ENHANCED MEASUREMENT REPORT message (see sub-clause 5.6.1) if all of the following conditions are met:

- the mobile station supports "UTRA (respectively E-UTRA) CSG Cells Reporting";
- the CSG Whitelist (see 3GPP TS 23.122) of the mobile station is not empty;
- the *UTRAN CSG Cells Reporting Description* IE (respectively *E-UTRAN CSG Cells Reporting Description* IE) has been received from the network (see subclause 5.6.1);
- the mobile station has determined that it is allowed to access the cell, i.e. the CSG ID and the PLMN ID of the CSG cell matches one of the CSG IDs with their associated PLMN IDs stored in its CSG Whitelist and the PLMN ID of the CSG cell matches the PLMN ID in the RAI received during latest registration or registration update with PS domain or that of an equivalent PLMN;
- the reporting criteria specified in 3GPP TS 45.008 are met.

Under these conditions, the mobile station may report a E-UTRAN or UTRAN CSG cell or detected hybrid cell by including the *E-UTRAN CSG Measurement Report* IE or the *UTRAN CSG Measurement Report* IE in the PACKET MEASUREMENT REPORT or the PACKET ENHANCED MEASUREMENT REPORT message.

If one or more of these conditions are not met the multi-RAT mobile station in packet transfer mode may only report a UTRAN or E-UTRAN cell detected as a hybrid cell in a PACKET MEASUREMENT REPORT message or PACKET ENHANCED MEASUREMENT REPORT message using the procedures for non-CSG cells defined in subclause 5.6.

A multi-RAT mobile station in NC2 mode may send a PACKET CELL CHANGE NOTIFICATION message on PACCH in place of a PACKET MEASUREMENT REPORT message or PACKET ENHANCED MEASUREMENT REPORT message (see sub-clause 5.6.1), indicating a target cell which is a CSG cell or detected hybrid cell whose CSG ID is in the CSG whitelist of the MS if all of the following conditions are met:

- the CSG Whitelist of the mobile station is not empty; and
- for a UTRAN cell, either the MS does not support "UTRA CSG Cells Reporting" or the *UTRAN CSG Cells Reporting Description* IE has not been received from the network (or both); and
- for an E-UTRAN cell, either the MS does not support "E-UTRA CSG Cells Reporting" or the *E-UTRAN CSG Cells Reporting Description* IE has not been received from the network (or both); and
- the cell reselection criteria for autonomous reselection towards a CSG cell in NC0/NC1 mode (see 3GPP TS 45.008) have been met and;
- the *NC2\_CSG\_PCCN\_permitted* field (see 3GPP TS 44.018) has been received in System Information Type 2quater and is equal to '1'.

NOTE: The sending of the PACKET CELL CHANGE NOTIFICATION message when these conditions are met is not conditional on the setting of 3G\_CCN\_ACTIVE or E-UTRAN\_CCN\_ACTIVE.

If these conditions are met and a mobile station sends a PACKET CELL CHANGE NOTIFICATION message, it shall indicate the CSG cell as the target cell in the PACKET CELL CHANGE NOTIFICATION message using the *3G Target Cell Struct* or *E-UTRAN Target Cell Struct* and shall include the CSG Discriminator bit. The remaining contents of the PACKET CELL CHANGE NOTIFICATION message shall be as specified for the case of entering CCN mode (see sub-clause 8.8.3). The network may respond to the PACKET CELL CHANGE NOTIFICATION with a PACKET CELL CHANGE ORDER message. The mobile station shall not enter CCN mode and shall not perform a cell change unless a PACKET CELL CHANGE ORDER message is received.

NOTE: The use of PACKET CELL CHANGE NOTIFICATION message to report a CSG cell by a mobile station in packet transfer mode in NC0/NC1 mode (including the case where the MS supports CSG Cells Reporting and the *CSG Cells Reporting Description* IE has been received from the network) is specified in sub-clause 8.8.3.

The CSG Discriminator shall be incremented by one modulo 2 whenever the mobile station reports a different CSG cell having the same physical layer parameters as the previously reported CSG cell. The initial value of the CSG

Discriminator is 0. The mobile station shall use individual sequences of CSG Discriminator for CSG cells with different physical layer parameters.

When the mobile station leaves NC2 mode or moves to a new cell, the mobile station shall delete all CSG Discriminator information.

#### 5.6.4 Measurement reporting in broadcast/multicast receive mode

The mobile station in broadcast/multicast receive mode shall report neighbouring cell measurements when polled for an MBMS DOWNLINK ACK/NACK message according to the procedures specified in sub-clause 8.1.4.2. Measurement reporting in broadcast/multicast receive mode shall not affect the procedure for NC measurement reporting defined in sub-clause 5.6.1.

For reporting neighbouring cells in the MBMS Neighbouring Cell Report struct, the following rules apply:

- the neighbouring cells shall belong to the six strongest non-serving and allowed (see 3GPP TS 45.008) carriers
- the cells for which cell reselection parameters have been acquired, shall be reported in decreasing order of the corresponding cell re-selection ranking (see 3GPP TS 45.008), i.e. the highest ranked first.
- the neighbouring cells for which cell reselection parameters have not been acquired, shall be reported in decreasing order of the received signal level average (see 3GPP TS 45.008), i.e. the neighbouring cell with highest received signal average first.
- in case there are cells for which cell reselection parameters have and cells for which cell reselection parameters have not been acquired to be included in the MBMS Neighbouring Cell Report struct, the cells shall be reported in alternating order, starting with the highest ranked cell for which cell reselection parameters have been acquired.
- the MBMS Neighbouring Cell Report struct shall include as many cells as possible but shall not exceed 6 cells.

EXAMPLE: there is space to report 4 neighbouring cells in the MBMS DOWNLINK ACK/NACK message.

In this case, the neighbouring cells in the MBMS Neighbouring Cell Report struct shall be reported in the following order :

y(1), n(1), y(2), y(3), cells y(4) and y(5) are not reported,

where

y(1) is the highest ranked cell for which cell reselection parameters have been acquired  
 y(2) is the 2<sup>nd</sup> highest ranked cell for which cell reselection parameters have been acquired  
 y(3) is the 3<sup>rd</sup> highest ranked cell for which cell reselection parameters have been acquired  
 y(4) is the 4<sup>th</sup> highest ranked cell for which cell reselection parameters have been acquired  
 y(5) is the 5<sup>th</sup> highest ranked cell for which cell reselection parameters have been acquired  
 n(1) is the highest ranked (and the only one within the 6 strongest) cell for which cell reselection parameters have not been acquired

If cell re-selection is triggered towards a neighbouring cell (see 3GPP TS 45.008), the mobile station shall indicate this to the network with the RESEL\_CRITERIA\_FULFILLED parameter when reporting measurement results for that cell. In this case, the mobile station shall not include any other measurement results for any other neighbouring cell in the MBMS Neighbouring Cell Report struct.

When reporting measurement results for a neighbouring cell, the mobile station shall indicate with the RESEL\_PARAMS\_ACQUIRED parameter whether it has acquired the reselection parameters for that cell. The mobile station shall also indicate whether it has received (as described in sub-clause 7.7.3) the MBMS bearer parameters in that cell for the MBMS session acknowledged in the MBMS DOWNLINK ACK/NACK message. If so the mobile station shall indicate the latest corresponding (i.e. for that cell and that session) MBMS\_PTM\_CHANGE\_MARK parameter received. The network may use this information to schedule MBMS NEIGHBOURING CELL INFORMATION messages accordingly. If for a given session the network has received from a mobile station an indication that no MBMS bearer parameters for that session in a neighbouring cell have been received, the network may establish that

session in that neighbouring cell, if not already established provided that that cell supports MBMS and belongs to the MBMS service area.

## 5.7 Dual transfer mode enhancements

The mobile station and the network may support enhanced DTM CS establishment and enhanced DTM CS release procedures, called DTM enhancements.

By using enhanced DTM CS establishment procedure, an RR connection can be initiated by either the mobile station or the network while the mobile station is in packet transfer mode. The procedure is specified in sub-clause 8.9.

By using enhanced DTM CS release, the network may delay the release of the RR connection until the mobile station in dual transfer mode has received the required system information, in order to maintain the radio resources (PDCH(s)) after the release of the RR connection while in dual transfer mode, as specified in sub-clause 5.5.1.1b.5.

The support of the DTM enhancements is optional for the mobile station and the network and is indicated in the *Mobile Station Classmark 3 IE*, the *MS Radio Access Capability IE* and the *GPRS Cell Options IE*. A mobile station supporting the DTM enhancements shall also support the extended RLC/MAC control message segmentation as defined in 9.1.12a. The DTM enhancements shall be used if the mobile station and the network support them.

## 5.8 DTM Handover

Mobile station and network support for DTM handover is optional. The mobile station shall indicate its support for DTM handover in the *Mobile Station Classmark 3 IE* and the *MS Radio Access Capabilities IE* (see 3GPP TS 24.008). A mobile station supporting DTM handover shall also support the extended RLC/MAC control message segmentation as defined in sub-clause 9.1.12a. The DTM handover procedure consists of the CS handover procedure (see 3GPP TS 44.018) and the PS handover procedure (see sub-clause 8.10) running in parallel with exceptions as outlined in 3GPP TS 48.008.

## 5.9 Downlink Dual Carrier

Mobile station and network support for Downlink Dual Carrier is optional. The mobile station shall indicate its support for Downlink Dual Carrier in the *MS Radio Access Capabilities IE* (see 3GPP TS 24.008). A mobile station and a network that support Downlink Dual Carrier shall also support EGPRS TBFs. A mobile station supporting Downlink Dual Carrier shall also support the extended RLC/MAC control message segmentation as defined in sub-clause 9.1.12a.

Downlink Dual Carrier enables downlink TBFs and uplink TBFs to use allocated resources on one or more assigned PDCHs on two different radio frequency channels. Uplink RLC/MAC blocks shall not be scheduled on both carriers of a downlink dual carrier configuration in the same radio block period. Downlink RLC/MAC blocks may be scheduled on both carriers of a downlink dual carrier configuration in the same radio block period.

If the network initially assigns a mobile station radio resources on only one carrier, it can extend this assignment to a downlink dual carrier configuration by sending a new single carrier assignment to the mobile station including assigned radio resources for the second carrier, without changing the resources already assigned for the initial carrier. Alternatively the network can include radio resources for two carriers in an initial or subsequent assignment message.

## 5.10 ETWS Primary Notification

Mobile station support for reception of Earthquake and Tsunami Warning System (ETWS) Primary Notification messages is optional. A mobile station supporting reception of ETWS Primary Notification shall also support the extended RLC/MAC control message segmentation as defined in sub-clause 9.1.12a.

## 5.11 Enhanced Multiplexing for Single TBF

Mobile station and network support for Enhanced Multiplexing for Single TBF (EMST) is optional. The mobile station shall indicate its support for EMST in the *MS Radio Access Capability IE* (see 3GPP TS 24.008). The mobile station supporting EMST and RLC non-persistent mode shall be able to operate up to three RLC entities on a single TBF concurrently. The mobile station supporting EMST and not supporting RLC non-persistent mode shall be able to

operate up to two RLC entities on a single TBF concurrently. A mobile station and a network that support EMST shall also support EGPRS. A network supporting EMST shall also support the delayed release of downlink TBF and extended uplink TBF mode (see sub-clauses 9.3.1a and 9.3.1b).

EMST enables the allocation and multiplexing of one or more RLC entities on a single TBF. In the uplink, each RLC entity allocated on the TBF shall operate according to radio parameters (radio priority and peak throughput) of the PFC currently being served, however different RLC entities allocated on the same uplink TBF may operate according to different radio parameters. The RLC entities allocated on the TBF shall operate in different RLC modes. The TBF shall be maintained when packet transfer switches between RLC entities using different RLC modes and/or radio priorities. The network shall not assign more than one RLC entity operating in a give RLC mode to a single TBF.

NOTE: It is for further study, whether a specific PFC multiplexing shall apply if EMST is used.

Each RLC entity allocated on a TBF using EMST shall be assigned a unique TFI as specified in sub-clause 5.2.2.

An uplink TBF using EMST shall be assigned a unique USF as specified in sub-clause 5.2.3. The use of USF for an uplink TBF using EMST is the same as specified for an uplink TBF not using EMST.

On an uplink TBF using EMST, the mobile station shall use the same rules for multiplexing LLC PDUs as specified for a single RLC entity case, i.e. use peak throughput and radio priority to decide how data from different PFCs are multiplexed.

## 5.12 Enhanced Multiplexing for a Single RLC Entity

Mobile station and network support for Enhanced Multiplexing for a Single RLC Entity (EMSR) is optional. The mobile station shall indicate its support for EMSR in the *MS Radio Access Capability* IE (see 3GPP TS 24.008). A network that supports EMSR shall also support the delayed release of a downlink TBF and extended uplink TBF mode (see sub-clauses 9.3.1a and 9.3.1b). A mobile station that supports EMSR shall support extended uplink TBF mode.

EMSR is enabled for a given RLC entity when the network allocates multiple PFCs with at least two of them having unique TFI values within the context of that RLC entity. EMSR is disabled for a given RLC entity if that RLC entity is no longer allocated multiple PFCs with at least two of them having unique TFI values.

If EMSR is enabled for a given RLC entity then uplink resource reallocation/downlink resource reassignment is not performed whenever RLC data block transmission priority decisions made in the MS or in the BSS result in switching between PFCs assigned to the same RLC entity but having different TFI values. If EMSR is enabled and a new upper layer PDU becomes available but is not associated with a PFC for which the MS has already sent a PACKET RESOURCE REQUEST message (and received a corresponding assignment message), then the MS shall proceed as described in sub-clause 8.1.1.1.2 regarding how the transmission of the new LLC PDU is to be managed. Similarly, if EMSR is enabled and a new upper layer PDU becomes available but is not associated with a PFC for which the MS has already received a downlink assignment message then the BSS shall perform downlink resource reassignment and the MS shall proceed as described in sub-clause 8.1.2.4. An uplink TBF using EMSR shall be assigned a unique USF as specified in sub-clause 5.2.3.

If EMSR is enabled for a given RLC entity, the determination of the relative transmission priority of upper layer PDUs is implementation specific. The transmission of upper layer PDUs may be suspended or resumed depending on their relative priorities as specified in sub-clauses 9.1.11 and 9.1.12.

If EMSR is enabled for a given RLC entity, the network may send the mobile station an assignment message (e.g. PACKET TIMESLOT RECONFIGURE, PACKET UPLINK ASSIGNMENT or PACKET DOWNLINK ASSIGNMENT message) that excludes a subset of the PFCs previously allocated to that RLC entity without releasing the RLC entity. In this case:

- Upon reception of the assignment message, the mobile station may discard all upper layer PDUs corresponding to an excluded PFC for which transmission has not yet started.
- Upon determining that there are no outstanding upper layer PDUs corresponding to an excluded PFC, the mobile station shall consider that PFC as no longer allocated to the corresponding RLC entity. The mobile station shall also consider the TFI value associated with such a PFC as no longer allocated to the corresponding RLC entity if there are no remaining PFCs allocated to that RLC entity still associated with that TFI value.
- If the mobile station has more upper layer PDUs to send for an excluded PFC then it shall send a PACKET RESOURCE REQUEST message requesting resources for that PFC as described in this sub-clause.

## 5.13 Downlink Multi Carrier

Mobile station and network support for Downlink Multi Carrier is optional. The mobile station shall indicate its support for DLMC configuration in the *MS Radio Access Capability* IE (see 3GPP TS 24.008). A mobile station and a network that support DLMC configuration shall support:

- the assignment of only one EGPRS TBF on the downlink where multiple PDCHs may be assigned on two or more different radio frequency channels.
- extended RLC/MAC control message segmentation as defined in sub-clause 9.1.12a.
- the optional assignment of one EGPRS TBF on the uplink. If assigned, one or more PDCHs may be assigned on one or more uplink radio frequency channels where each uplink radio frequency channel corresponds to an assigned downlink radio frequency channel.

A mobile station that supports DLMC configuration shall, within the *MS Radio Access Capability* IE (see 3GPP TS 24.008), indicate the maximum number of downlink carriers it supports, the maximum number of downlink timeslots it supports, the maximum bandwidth it supports, and whether or not it support non-contiguous intra-band reception and/or inter-band reception.

A mobile station that supports DLMC configuration may be assigned one or more UFPS (see 3GPP TS 45.008 [15]) where the assigned UFPS(s) and their associated carriers are numbered as described in sub-clause 8.1.1.1.3. For the case where a UFPS is defined by a mobile allocation (see sub-clause 12.10a) a mobile station in DLMC configuration will perform carrier selection to determine the set of downlink carriers it can receive during any given radio block period as described in 3GPP TS 45.002 [13].

In DLMC configuration RLC/MAC blocks shall not be scheduled on multiple uplink carriers in the same radio block period whereas RLC/MAC blocks may be scheduled on one or more downlink carriers in the same radio block period.

If the maximum number of downlink timeslots a mobile station supports in a DLMC configuration is greater than 20 then it shall, in addition to supporting the EGPRS sequence number space (SNS) and window size, support an extended SNS of 8192, an extended window size (see sub-clause 9.0, 10.4.12 and 9.19), the assignment of eTFI values (see sub-clause 10.0a.2 and 10.0a.3) and CS-3 coding of EGPRS PACKET DOWNLINK ACK/NACK DLMC messages. The sequence number space to be used and the assigned eTFI values are indicated in the assignment message (see sub-clause 11.2.7).

In DLMC configuration where eTFI values are assigned, the mobile station uses eTFI in combination with TFI to determine if the message (PACCH, PAN or a RLC data block) is addressed to it. See sub-clause 8.1.1.1.1, 8.1.1.2.2 and 8.1.2.1 for the use of eTFI.

A mobile station in DLMC configuration where the continuous timing advance procedure is used shall fall back to single carrier configuration for PTCCH reception during each PTCCH frame occurring on the corresponding radio frequency channel (see sub-clause 7.1.2.5). In addition, the mobile station shall fall back to single carrier configuration for radio block reception according to a regular pre-determined interval (see 3GPP TS 45.002 [13]) using the radio frequency channel of its assigned PTCCH or using the radio frequency channel of the lowest numbered carrier (see sub-clause 8.1.1.1.3) if it has not been assigned a PTCCH. When inter-band reception is used in DLMC configuration (see 3GPP TS 45.005 and 3GPP TS 45.002), fall back to single carrier configuration only applies to the frequency band where the PTCCH is assigned or where the lowest numbered carrier is assigned (if a PTCCH has not been assigned).

If a mobile station is using the continuous timing advance procedure, it shall, upon receiving an assignment message that causes it to enter DLMC configuration, continue to use the current PTCCH information for as long as the corresponding downlink carrier remains assigned unless one of the following occurs:

- the current assignment message provides it with new PTCCH information.
- a subsequent assignment message or a Packet Power Control/Timing Advance message provides it with new PTCCH information.
- a subsequent assignment message results in the mobile station no longer being in a DLMC configuration (but still in packet transfer mode) in which case it shall consider the PTCCH allocation to be on the remaining carrier.



## 6 Paging procedures

For a mobile station in packet idle mode, the network may use the paging procedures to initiate the establishment of an RR connection, to trigger a cell update from the mobile station prior to a downlink packet transfer, or to send MBMS notification. A number of mobile stations can be paged for either downlink packet transfer or RR connection establishment in the same paging message.

For a mobile station in packet transfer mode, the network may use the paging procedures to initiate the establishment of an RR connection. A number of mobile stations can be paged for RR connection establishment in the same paging message. After sending the mobile station a PS HANDOVER COMMAND message the network shall not use paging procedures to initiate the establishment of an RR connection for that mobile station until the PS handover procedure has been completed (see sub-clause 8.10).

Paging procedures for RR connection establishment are described in sub-clause 6.1. Paging procedures for downlink packet transfer are described in sub-clause 6.2.

### 6.1 Paging procedure for RR connection establishment

The network may initiate the establishment of an RR connection by the paging procedure for RR connection establishment.

The network initiates the paging procedure for RR connection establishment by sending a paging request message on the appropriate paging subchannel on CCCH or PCCCH, addressing the mobile station and indicating RR connection establishment.

The paging subchannels on CCCH and PCCCH are specified in 3GPP TS 45.002 and 3GPP TS 43.013. The paging request message for RR connection establishment is sent on the PCCCH if the mobile station is GPRS attached, PCCCH is present in the cell and the network operates in network mode of operation I (see 3GPP TS 23.060). Otherwise, the paging request message is sent on CCCH.

The network may also page the mobile station for RR connection establishment by sending a paging request message on PACCH if the mobile station is in packet transfer mode.

A mobile station in packet transfer mode is not required to decode the paging subchannels, on neither CCCH nor PCCCH, in the following two cases:

- the mobile station is not capable to handle an RR connection and a TBF simultaneously (GPRS class B mode of operation); or
- the mobile station requires that the BSS co-ordinates the allocation of radio resources for an RR connection and one or more simultaneous TBFs (GPRS class A mode of operation by means of DTM).

#### 6.1.1 Paging initiation using paging subchannel on CCCH

The paging initiation procedure and the paging request messages used on CCCH are specified in 3GPP TS 44.018.

#### 6.1.2 Paging initiation using paging subchannel on PCCCH

The network initiates the paging procedure by sending a PACKET PAGING REQUEST message on an appropriate paging subchannel on PCCCH, considering the DRX parameters valid for each targeted mobile station.

For each mobile station, that is paged for RR connection establishment, a channel needed field is included in the PACKET PAGING REQUEST message, see sub-clause 11.2.10. The channel needed field defines how the mobile stations shall use the establishment cause field in the CHANNEL REQUEST message, as specified in 3GPP TS 44.018.

#### 6.1.3 Paging initiation using PACCH

Paging initiation using PACCH applies when sending a paging request message to a mobile station that is GPRS attached, when the mobile station is in packet transfer mode or in broadcast/multicast receive mode, if so indicated for

that mobile by the network, and the network is able to co-ordinate the paging request with the radio resources allocated for the mobile station (or MBMS session) on a PDCH.

This kind of paging co-ordination shall be provided in network mode of operation I (see 3GPP TS 23.060). A mobile station in packet transfer mode in a cell indicating support of network mode of operation I in the NMOrelated fields broadcast on BCCH or PBCCH shall expect the paging messages to be received on the PACCH.

This kind of paging co-ordination shall be provided for mobile stations capable of DTM if the network supports DTM. A mobile station capable of DTM in packet transfer mode in a cell indicating support of DTM procedures in the *DTM\_SUPPORT* field broadcast on BCCH or PBCCH shall expect the paging messages to be received on the PACCH.

This kind of paging co-ordination may be provided also in network mode of operation II or III regardless of the DTM capability of the cell and of the mobile station and shall be indicated in that case by setting the *BSS\_PAGING\_COORDINATION* field to "The cell supports Circuit-Switched paging coordination" on BCCH or PBCCH. If such indication is received, a mobile station in packet transfer mode shall expect the paging messages to be received on the PACCH.

A mobile station in broadcast/multicast receive mode shall expect the paging messages to be received on the PACCH of an MBMS radio bearer if the network has indicated so with the *MBMS In-band Signalling Indicator* field in the MBMS ASSIGNMENT and/or MBMS NEIGHBOURING CELL INFORMATION messages, and if the mobile station has an MS\_ID on that MBMS radio bearer.

The network shall not send paging messages on the PACCH to a mobile station whose MS\_ID has been released because the mobile station has not responded when being polled (i.e. T3195 has started for that MS\_ID).

If a mobile station is receiving multiple MBMS radio bearers and the mobile station has an MS\_ID on at least one of the MBMS radio bearers where the network has indicated that system information for the serving cell and paging messages are sent on the PACCH/D then the mobile station shall not monitor its paging group on the (P)CCCH in parallel to the MBMS radio bearers. The network shall send the PACKET PAGING REQUEST message to the mobile station on the appropriate PACCH. The message includes the mobile station identification and the channel needed field which defines how the mobile station shall use the establishment cause field in the CHANNEL REQUEST message, as specified in 3GPP TS 44.018.

## 6.1.4 Paging response

Upon receipt of a Paging Request or Packet Paging Request message, for the purpose of triggering an RR connection establishment, a mobile station operating in GPRS class B mode of operation and in packet transfer mode shall either ignore or respond to the paging request according to 3GPP TS 22.060.

When the mobile station responds to a paging request for RR connection establishment, it shall follow the paging response procedures as specified in 3GPP TS 44.018. For that purpose, a mobile station in packet transfer mode or a mobile station that has initiated a packet access procedure may abort all ongoing TBFs or the packet access procedure in the following two cases:

- the mobile station is not capable to handle an RR connection and a TBF simultaneously (GPRS class B mode of operation or a mobile station in DLMC configuration); or
- the mobile station requires that the BSS co-ordinates the allocation of radio resources for an RR connection and one or more simultaneous TBFs (GPRS class A mode of operation by means of DTM).

## 6.2 Paging procedure for downlink packet transfer

The network may initiate the paging procedure for downlink packet transfer in order to obtain the mobile station cell location required for the downlink packet transfer. The procedure is triggered by a page request from the GMM sublayer on the network side, see 3GPP TS 24.007 and 3GPP TS 44.018. The procedure is initiated by sending a paging request message on the appropriate paging subchannel on CCCH or PCCCH. The paging subchannels on CCCH and PCCCH are specified in 3GPP TS 45.002 and 3GPP TS 43.013.

The paging request message is sent on PCCCH, if PCCCH is present in the cell. Otherwise, the paging request message is sent on CCCH.

A mobile station that indicates DTM support to the network is not required to decode the paging subchannels, on neither CCCH nor PCCCH, while it is in dedicated mode. If the cell location for a mobile station that has indicated

DTM support is required while the mobile station is in dedicated mode, the network may use the packet notification procedure defined in 3GPP TS 44.018.

### 6.2.1 Paging procedure using paging subchannel on CCCH

The packet paging procedure and the paging request messages used on CCCH are specified in 3GPP TS 44.018.

### 6.2.2 Paging using paging subchannel on PCCCH

The network initiates the paging procedure by sending a PACKET PAGING REQUEST message on an appropriate paging subchannel on PCCCH, considering the DRX parameters valid for each targeted mobile station.

### 6.2.3 Paging response

On receipt of a PACKET PAGING REQUEST message, the RR sublayer of addressed mobile station indicates the receipt the paging request to the GMM sublayer (see 3GPP TS 24.007 and 3GPP TS 44.018).

NOTE: The mobile station performs a pageresponse by sending an upper layer PDU to the network as defined in 3GPP TS 44.018 and 3GPP TS 44.064. The transfer of an upper layer PDU may serve as a cell update.

## 6.3 Paging Procedures for MBMS Notification

### 6.3.1 Notification to mobile station in packet idle mode

#### 6.3.1.1 General

The paging procedure for MBMS notification of an MBMS session is initiated by the reception of an MBMS-SESSION-START-REQUEST PDU or of an MBMS-SESSION-UPDATE-REQUEST PDU from the SGSN for this session, see 3GPP TS 48.018. The MBMS notification may be repeated during the session.

The network initiates the paging procedure for MBMS notification on PCCCH (sub-clause 6.3.1.3) if PCCCH is present in the cell, otherwise on CCCH (sub-clause 6.3.1.2). The paging procedure for MBMS notification is also initiated on PACCH when the mobile station is in broadcast/multicast receive mode, if so indicated for that mobile station by the network (sub-clause 6.3.1.3a).

The paging procedure for MBMS notification consists of the following steps:

optionally, the pre-notification of the MBMS session; and

the notification of the MBMS session.

A mobile station in broadcast/multicast receive mode shall remain in broadcast/multicast receive mode if a paging procedure for a new MBMS session is not completed for any reason.

#### 6.3.1.2 Paging procedure for MBMS notification using paging subchannel on CCCH

The paging procedure for MBMS notification and the paging request messages used on CCCH are specified in 3GPP TS 44.018.

#### 6.3.1.3 Paging procedure for MBMS notification using paging subchannel on PCCCH

##### 6.3.1.3.1 General

The network initiates the paging procedure for MBMS notification of an MBMS session by sending a PACKET PAGING REQUEST message including for that session either the MBMS pre-notification (see sub-clause 6.3.1.3.2) or

MBMS notification (see sub-clause 6.3.1.3.3) on one or more paging subchannels on PCCCH. The PACKET PAGING REQUEST message may also contain other MBMS (pre)notification(s) and/or pages as described in sub-clauses 6.1.2 and 6.2.2. The following requirements apply:

- If in the PACKET PAGING REQUEST message the mobile station is at the same time (pre)notified (see sub-clauses 6.3.1.3.2 and 6.3.1.3.3) and paged, the mobile station shall discard all (pre)notification(s) in that message and proceed as described in sub-clause 6.1 or 6.2, whichever applies.
- If in the PACKET PAGING REQUEST message the mobile station is at the same time pre-notified (see sub-clause 6.3.1.3.2) and notified (see sub-clause 6.3.1.3.3), the mobile station shall discard all pre-notifications in that message and proceed as described in sub-clause 6.3.1.3.3.

### 6.3.1.3.2 MBMS pre-notification

In order to pre-notify an MBMS session, the network shall send a PACKET PAGING REQUEST message by including for that session only the TMGI and, if available, the MBMS Session Identity of that session as contained in the MBMS-SESSION-START-REQUEST PDU or in the MBMS-SESSION-UPDATE-REQUEST PDU.

Upon reception of a PACKET PAGING REQUEST message including for an MBMS session only the TMGI and, if available, the MBMS Session Identity of that session, and if the mobile station requires reception of that session, the mobile station shall consider that session as being pre-notified (i.e. the mobile station is pre-notified). If the mobile station determines several pre-notified sessions in this message, the mobile station shall discard all pre-notifications but the pre-notification for the highest priority session. The mobile station in packet idle mode or MAC-Idle state shall then enter non-DRX mode, start timer T3220 and proceed as described in sub-clause 6.3.1.3.3.

**NOTE:** In case all pre-notified sessions have the same priority, the selection of the highest priority session is implementation-dependent.

While timer T3220 is running, the mobile station shall stop timer T3220 and discard the pre-notification if:

- Any other procedure on PCCCH not related to MBMS is triggered. The mobile station shall then proceed as per that procedure.
- A notification is received for a higher priority session. The mobile station shall then proceed as described in sub-clause 6.3.1.3.3.

If while timer T3220 is running the mobile station receives a pre-notification for a higher priority session, the mobile station shall discard the pre-notification for the lower priority session, remain in non-DRX mode, restart timer T3220 and proceed as described in sub-clause 6.3.1.3.3.

Upon expiry of timer T3220, the mobile station in packet idle mode or MAC-Idle state shall return to DRX mode and discard the pre-notification. The mobile station in broadcast/multicast receive mode shall discard the pre-notification and remain in broadcast/multicast receive mode.

A mobile station in broadcast/multicast receive mode that is receiving an MBMS session shall ignore repeated pre-notifications of that session.

### 6.3.1.3.3 MBMS notification

In order to notify an MBMS session, the network shall send a PACKET PAGING REQUEST message by including for that session:

- the TMGI and, if available, the MBMS Session Identity of that session;
- an indication whether counting shall be performed or not;
- optionally the MBMS p-t-m channel description allocated to that session and the estimated duration of the MBMS session or, if the MBMS session is ongoing, the estimated remaining duration of the MBMS session;
- optionally the MPRACH description.

NOTE 1: If the *MBMS Session Repetition Number* IE is included in the MBMS-SESSION-START-REQUEST PDU or in the MBMS-SESSION-UPDATE-REQUEST PDU (see 3GPP TS 48.018), the value part of this IE may be used by the network for e.g. deciding whether or not to perform the counting procedure or, in conjunction with the values of *Allocation/Retention Priority* IE (see 3GPP TS 48.018), whether or not to establish an MBMS radio bearer for the session.

Upon reception of a PACKET PAGING REQUEST message including the notification of an MBMS session and if the mobile station requires reception of this session, the mobile station shall consider that session as being notified (i.e. the mobile station is notified). If the mobile station determines several notified sessions in this message, the mobile station shall act upon the notification for the highest priority session. The mobile station shall then stop timer T3220, if running, and proceed as described in sub-clause 6.3.1.4.

NOTE 2: In case all notified sessions have the same priority, the selection of the highest priority session is implementation-dependent.

NOTE 3: Depending on its capabilities, the MS may act upon the notification for lower priority MBMS sessions provided it does not affect any of the following procedures for the highest priority MBMS session: response to MBMS notification (see sub-clause 6.3.1.4), establishment of MBMS bearer upon receipt of MBMS ASSIGNMENT message (see sub-clause 7.7.2.2), MBMS packet access procedure (see sub-clause 7.7.1).

A mobile station in broadcast/multicast receive mode that is receiving an MBMS session shall ignore repeated notifications of that session.

### 6.3.1.3a Paging procedure for MBMS notification using PACCH

A mobile station in broadcast/multicast receive mode shall expect the paging messages to be received on the PACCH of an MBMS radio bearer if the network has indicated so with the *MBMS In-band Signalling Indicator* field in the MBMS ASSIGNMENT and/or MBMS NEIGHBOURING CELL INFORMATION messages, and if the mobile station has an MS\_ID on that MBMS radio bearer.

Under the above circumstances, the network initiates the paging procedure for MBMS notification of an MBMS session not only on PCCCH (see sub-clause 6.3.1.3) if PCCCH is present in the cell, otherwise on CCCH (see sub-clause 6.3.1.2), but also by sending a PACKET PAGING REQUEST message including for that session either the MBMS pre-notification (see sub-clause 6.3.1.3.2) or MBMS notification (see sub-clause 6.3.1.3.3) on the appropriate PACCH. The PACKET PAGING REQUEST message may also contain other MBMS (pre-)notification(s) and/or pages as described in sub-clauses 6.1.2 and 6.2.2 (see sub-clause 6.3.1.3.1).

The network shall not send paging messages on the PACCH to a mobile station whose MS\_ID has been released because the mobile station has not responded when being polled (i.e. T3195 has started for that MS\_ID).

Upon reception of MBMS notification on PACCH, the mobile station in broadcast/multicast receive mode shall act according to sub-clause 8.1.5.2.

If the mobile station responds to the MBMS notification:

- it shall act as described in sub-clause 6.3.1.4 if PCCCH is present in the cell;
- otherwise it shall act as described in 3GPP TS 44.018 (sub-clause 3.5.1.3.4).

### 6.3.1.4 Response to MBMS Notification

If the MBMS notification indicates that no counting shall be performed and contains no MBMS p-t-m channel description, the mobile station shall remain in or enter non-DRX mode and start timer T3214. Upon expiry of timer T3214, a mobile station in packet idle mode or MAC-Idle state (respectively broadcast-multicast receive mode) shall enter DRX mode (respectively remain in broadcast-multicast receive mode) and discard the corresponding notification. Upon reception of an MBMS ASSIGNMENT message for that session, the mobile station shall stop timer T3214 and shall proceed as described in sub-clause 7.7.2.2.

While timer T3214 is running, the mobile station shall stop timer T3214 if:

- Any other procedure on PCCCH not related to MBMS is triggered. The mobile station shall then proceed as per that procedure;

- A notification is received for a higher priority session. The mobile station shall then proceed as per that notification. Depending on its capabilities, the MS may act upon the notification for the lower priority MBMS session provided it does not affect any of the following procedures for the higher priority MBMS session: response to MBMS notification (see present sub-clause), establishment of MBMS bearer upon receipt of MBMS ASSIGNMENT (see sub-clause 7.7.2.2), MBMS packet access procedure (see sub-clause 7.7.1).

If the MBMS notification indicates that counting shall be performed the mobile station shall perform an MBMS packet access procedure, as described in sub-clause 7.7.1.

If the MBMS notification includes an MBMS p-t-m channel description the mobile station shall set and start the session duration timer for this MBMS session with a value equal to the Estimated Session Duration (included in the MBMS Session Parameters List) and shall use information received on the PBCCH to decode the channel descriptions contained in the assignment. If frequency hopping is applied, the mobile station shall use the last CA (Cell Allocation) received on PBCCH to decode the Mobile Allocation. Alternatively, the network may provide a Mobile Allocation in the assignment. If an MBMS Radio Bearer Starting Time is indicated, the mobile station shall monitor PCCCH until the point in time denoted by the MBMS Radio Bearer Starting Time. The mobile station shall then switch to the assigned PDCHs and start timer T3190. If the MBMS Radio Bearer Starting Time has already elapsed or is not present, the mobile station shall switch to the assigned PDCHs and start timer T3190. The timer T3190 is restarted when receiving the first valid RLC data block for that session. In EGPRS TBF mode T3190 is also restarted when receiving an erroneous RLC data block for which the header is correctly received and which addresses the mobile station. The mobile station is not allowed to send normal bursts on the uplink unless it has a valid timing advance, and is assigned an MS\_ID for that session. If the mobile station receives more than one MBMS notification including an MBMS p-t-m channel description for that same session while it monitors PCCCH, it shall act upon the most recently received assignment for that session and shall ignore the previous assignment.

On expiry of timer T3190, the mobile station shall abort the procedure and return to packet idle mode or MAC-Idle state. The mobile station in broadcast/multicast receive mode shall abort the procedure and remain in broadcast/multicast receive mode.

## 6.3.2 Notification to mobile station in packet transfer mode or in dual transfer mode

### 6.3.2.1 General

MBMS notification initiation using PACCH applies when sending an MBMS notification to a mobile station or a group of mobile stations that is/are in packet transfer mode or in dual transfer mode.

### 6.3.2.2 MBMS Notification using the PACCH

The network may send the PACKET MBMS ANNOUNCEMENT message on any PDCH.

Upon receipt of a PACKET MBMS ANNOUNCEMENT message containing a TMGI and optionally an MBMS Session Identity corresponding to an MBMS session the mobile station is required to receive, the mobile station shall pass an indication including the TMGI, and when available the MBMS Session Identity, to the upper layers. If the Restriction Timer is included in the received PACKET MBMS ANNOUNCEMENT message, the mobile station shall set and start an instance of the T3222 to the value indicated in the Restriction Timer field, otherwise if the Estimated Session Duration is included in the received PACKET MBMS ANNOUNCEMENT message the mobile station shall set and start both an instance of the T3222 and the session duration timer for this MBMS session with a value equal to the Estimated Session Duration. The mobile station shall store the MBMS specific information contained in the PACKET MBMS ANNOUNCEMENT message.

If T3222 expires the mobile station shall discard the stored MBMS information associated with this instance of T3222.

### 6.3.2.3 Response to MBMS Notification received on PACCH

If the mobile station enters packet idle mode and completes the Transfer non-DRX mode period before the expiry of T3222 or where no instance of T3222 was set and the PACKET MBMS ANNOUNCEMENT message did not include the MBMS p-t-m channel description, the mobile station shall stop T3222, if started, and initiates the MBMS Packet Access Procedure on a PCCCH (sub-clause 7.7.1.2) or, if a packet control channel does not exist, on a CCCH (sub-clause 7.7.1.3) or, if the PACKET MBMS ANNOUNCEMENT message contained uplink resource description for an MPRACH, on that MPRACH (sub-clause 7.7.1.4).

Any MPRACH description or MBMS p-t-m channel description stored from a previously received PACKET MBMS ANNOUNCEMENT message shall be deleted after the mobile station completes cell reselection or after a handover procedure is completed.

If the mobile station enters packet idle mode before the expiry of T3222 and the PACKET MBMS ANNOUNCEMENT message included the MBMS p-t-m channel description, the mobile station shall stop T3222 and shall start listening to downlink RLC blocks identified by the assigned TFI on the defined PDCHs either at the point in time denoted by the MBMS Radio Bearer Starting Time, if present and not already elapsed, or immediately otherwise.

The mobile station shall follow the procedures described in sub-clause 6.3.1.4.

## 6.4 Paging Procedure for ETWS Primary Notification delivery

### 6.4.1 General

The network may initiate the paging procedure for delivery of an ETWS Primary Notification message (see 3GPP TS 23.041) on PCCCH (sub-clause 6.4.3) if PCCCH is present in the cell, otherwise on CCCH (sub-clause 6.4.2).

### 6.4.2 ETWS Primary Notification delivery using paging subchannel on CCCH

The paging procedure for ETWS Primary Notification delivery and the paging request messages used on CCCH are specified in 3GPP TS 44.018.

### 6.4.3 ETWS Primary Notification delivery using paging subchannel on PCCCH

The network initiates the paging procedure for delivery of an ETWS Primary Notification message (see 3GPP TS 23.041) by broadcasting the PACKET PAGING REQUEST message on all paging subchannels on PCCCH with the ETWS Primary Notification field present. These paging messages are sent continuously during the ETWS warning period.

Each paging message carries a segment of the actual ETWS Primary Notification message, i.e. segmentation is applicable if an ETWS Primary Notification message is too large to fit into a single PACKET PAGING REQUEST message. In order to allow a mobile station to receive the segments in any order, the size of a specific segment (retransmitted during the ETWS warning period) shall not be altered. Segments belonging to the same ETWS Primary Notification message shall be given the same Primary Notification Identifier (PNI) value.

### 6.4.4 Reception of ETWS Primary Notification message

Upon receipt of a PACKET PAGING REQUEST message carrying a segment of an ETWS Primary Notification message, the mobile station shall leave DRX mode, start timer T3232, start reading all paging groups corresponding to its PCCCH\_GROUP and attempt to acquire all segments of the ETWS Primary Notification message, having the same Primary Notification Identifier (PNI) value, before delivering the assembled message to the upper layers.

While attempting to acquire the ETWS Primary Notification message a mobile station shall continue to follow packet idle mode and connection establishment procedures. Upon initiating cell reselection or connection establishment procedures (RR connection establishment or TBF establishment) while attempting to acquire an ETWS Primary Notification message, a mobile station shall discard any partially received ETWS Primary Notification message and stop timer T3232. The mobile station shall not attempt to acquire an ETWS Primary Notification message while performing a connection establishment procedure or while performing cell reselection.

If the mobile station detects a change in the PNI value prior to acquiring a complete ETWS Primary Notification message, it shall abort the current message, restart timer T3232 and attempt to acquire the new message.

When the mobile station successfully acquires a complete ETWS Primary Notification message it shall stop timer T3232 and enter DRX mode. If timer T3232 expires the mobile station shall abort the current message and enter DRX mode.

## 7 Medium Access Control (MAC) procedures on PCCCH

### 7.0 General

The establishment of a Temporary Block Flow (TBF) can be initiated by either the mobile station or the network.

The request for establishment of a TBF on PCCCH, if allocated in the cell, is described in this sub-clause. If no PCCCH is allocated in the cell, the establishment of a TBF occurs on CCCH as described in 3GPP TS 44.018.

For mobile stations in packet idle mode on PCCCH, measurement reports messages are sent on temporary fixed allocations without the establishment of an uplink TBF (see sub-clause 7.3).

#### 7.0a Support of multiple TBF procedures

If the mobile station supports multiple TBF procedures, the mobile station shall indicate its support in the Multiple TBF Capability field in the *MS Radio Access Capability 2* IE. If the network supports multiple TBF procedures, the network shall indicate its support in the Multiple TBF Capability field in the *GPRS Cell Options* IE.

If both the network and the mobile station support multiple TBF procedures, and if more than one request is received from upper layers to transfer upper layer PDUs for more than one PFC before the packet access procedure can be initiated by the mobile station, then the mobile station may initiate a packet access procedure requesting multiple TBFs.

During multiple TBF procedures in sub-clause 7:

- The mobile station shall support the PACKET RESOURCE REQUEST message to request a single uplink TBF;
- The mobile station may send the PACKET RESOURCE REQUEST message to request multiple uplink TBFs in the second phase of a two-phase access;
- The network shall support the PACKET UPLINK ASSIGNMENT message to assign a single uplink TBF;
- The network may send the MULTIPLE TBF UPLINK ASSIGNMENT message to assign one or more uplink TBFs to a mobile station that requested multiple TBFs in the PACKET RESOURCE REQUEST message. In this sub-clause this message shall only be sent in response to a multiple uplink resource request in the second part of a two-phase access.

#### 7.0b (void)

### 7.1 TBF establishment initiated by the mobile station on PCCCH

The purpose of the packet access procedure is to establish a TBF to support the transfer of upper-layer PDUs in the direction from the mobile station to the network. Packet access shall be done on PCCCH, as defined in this sub-clause, if a PCCCH exists. Otherwise, packet access shall be done on CCCH, as defined in 3GPP TS 44.018. The packet access can be done in either one phase (sub-clause 7.1.2) or in two phases (sub-clauses 7.1.2 and 7.1.3).

TBF establishment can also be done on PACCH if a TBF for transfer of upper-layer PDUs in the direction from the network to the mobile station is already established (see sub-clause 8.1.2.5). TBF establishment can also be done on PACCH if the mobile station is releasing a TBF for transfer of upper-layer PDUs in the direction from the mobile station to the network and TBF for transfer of upper-layer PDUs in the direction from the network to the mobile station is not established (see sub-clause 9.3.2.4 and sub-clause 9.3.3.3).

If the mobile station is in dedicated mode and both the network and the mobile station support DTM, the establishment of a TBF shall be performed by the DTM assignment procedures on the main DCCH, as defined in 3GPP TS 44.018.



The packet access procedure is initiated by the mobile station. Initiation is triggered by a request from upper layers to transfer an upper-layer PDU. The request from upper layers specifies throughput, RLC mode, an optional PFI, and a Radio Priority to be associated with the packet transfer or indicates that the packet to be transferred contains signalling. If both the network and the mobile station support the extended uplink TBF mode, the request from upper layers may also specify that the upper-layer PDU is meant to pre-allocate an uplink TBF (early TBF establishment). In this case, the mobile station shall use the two phase access procedure, setting the `EARLY_TBF_ESTABLISHMENT` field in the `PACKET RESOURCE REQUEST` message to indicate pre-allocation is required (as described in sub-clause 7.1.3).

A mobile station indicates its support of RLC non-persistent mode in the *RLC non-persistent mode capability* bit of the MS Radio Access Capability information element (see 3GPP TS 24.008).

A packet access procedure requesting multiple TBFs may be initiated by the mobile station if multiple TBF procedures are supported in the network and the mobile station (see sub-clause 7.0). Initiation is triggered when the mobile station receives more than one request from upper layers to transfer upper-layer PDUs before the packet access procedure can be initiated. Each request from upper layers specifies a PFI, RLC mode, Radio Priority and optionally an LLC mode to be associated with the packet transfer or indicates that the packet to be transferred contains signalling.

Upon such a request:

- if access to the network is allowed (sub-clause 7.1.1), the mobile station shall initiate the packet access procedure as defined in sub-clause 7.1.2.1;
- otherwise, the RR sublayer in the mobile station shall reject the request.

If the request from upper layers indicates signalling, the highest Radio Priority shall be used at determination if access to the network is allowed, and the acknowledged RLC mode shall be requested.

If both the mobile station and the BSS support multiple TBF procedures, or if the mobile station supports RLC non-persistent mode, the BSS may order its preferred RLC mode when establishing uplink TBF(s), independently of the RLC mode requested by the mobile station. In particular, if the mobile station supports RLC non-persistent mode the network may allocate an EGPRS TBF that uses this RLC mode.

## 7.1.1 Permission to access the network

The network broadcasts on PBCCH and PCCCH the list of authorised access classes and authorised special access classes in the `ACC_CONTR_CLASS` parameter.

Access to the network is allowed if the mobile station is a member of at least one authorised access class or special access class as defined in 3GPP TS 22.011.

## 7.1.2 Initiation of a TBF establishment

### 7.1.2.1 Initiation of the packet access procedure

The mobile station shall initiate the packet access procedure by scheduling the sending of `PACKET CHANNEL REQUEST` messages on the PRACH corresponding to its `PCCCH_GROUP` and simultaneously leaving the packet idle mode. The mobile station shall use the last access parameters received on PBCCH. At sending of the first `PACKET CHANNEL REQUEST` message, the mobile station shall store the value for the Retry (R) bit to be transmitted in all the subsequent MAC headers as 'MS sent channel request message once'. If a second `PACKET CHANNEL REQUEST` message is sent, the mobile station shall change the value for the Retry (R) bit to 'MS sent channel request message twice or more'.

While waiting for a response to the `PACKET CHANNEL REQUEST` message, the mobile station shall monitor the full PCCCH corresponding to its `PCCCH_GROUP`. The mobile station shall perform signal strength measurements as they are defined for packet idle mode, see 3GPP TS 45.008.

While monitoring the full PCCCH, the mobile station shall decode any occurrence of the `PERSISTENCE_LEVEL` parameter included in a message received on PCCCH. When the mobile station receives the `PERSISTENCE_LEVEL` parameter, the value of the `PERSISTENCE_LEVEL` parameter shall be taken into account at the next `PACKET CHANNEL REQUEST` attempt that follows.

A mobile station that is IMSI attached (GPRS class A or B mode of operation) shall respond to a `PACKET PAGING REQUEST` message indicating an RR connection establishment. For that purpose, the mobile station may abort the

packet access procedure, according to the conditions stated in sub-clause 6.1.4. The mobile station shall not respond to a PACKET PAGING REQUEST message indicating TBF establishment.

A mobile station that is not IMSI attached (GPRS class C mode of operation) shall not respond to any type of PACKET PAGING REQUEST messages during the packet access procedure, it shall only decode the PERSISTENCE\_LEVEL parameter, if that is included in the message.

The PACKET CHANNEL REQUEST messages are sent on PRACH and contain an indication of the type of access and parameters required to indicate the mobile station's demand of radio resource.

There are two formats of the PACKET CHANNEL REQUEST message containing either 8 bits or 11 bits of information. The format to be applied on PRACH is controlled by the parameter ACCESS\_BURST\_TYPE which is broadcast on PBCCH. The access type to be used in the PACKET CHANNEL REQUEST message for a non-EGPRS TBF mode capable MS or an EGPRS TBF mode capable MS in a non-EGPRS capable cell depends on the purpose of the packet access procedure as follows:

- If the purpose of the packet access procedure is to request multiple TBFs, the mobile station shall indicate 'Two phase access' in the PACKET CHANNEL REQUEST message;
- If the purpose of the packet access procedure is to request a single TBF, the mobile station shall indicate one of the following access causes:
  - If the mobile station intends to use the TBF to send user data, it shall request two phase access if the requested RLC mode is unacknowledged mode. If the requested RLC mode is acknowledged mode, the mobile station shall request either one phase access or two phase access. In case of two phase access, if both the mobile station and the BSS support multiple TBF procedures, the BSS may order its preferred RLC mode when establishing an uplink TBF, overriding the mobile station request;
  - If the purpose of the packet access procedure is to send a Page Response, the mobile station shall indicate 'Page Response' in the PACKET CHANNEL REQUEST message;
  - If the purpose of the packet access procedure is to send a Cell update (the mobile station was in GMM READY state before the cell reselection) the mobile station shall indicate 'Cell Update' in the PACKET CHANNEL REQUEST message;
  - If the purpose of the packet access procedure is for any other Mobility Management procedure, the mobile station shall indicate 'MM Procedure' in the PACKET CHANNEL REQUEST message;
  - If the purpose of the packet access procedure is to send a Measurement Report, the mobile station shall indicate 'Single block without TBF establishment' in the PACKET CHANNEL REQUEST message;
  - If the purpose of the packet access procedure is to send a PACKET PAUSE message, the mobile station shall indicate 'Single block without TBF establishment' in the PACKET CHANNEL REQUEST message. Upon the first attempt to send a PACKET CHANNEL REQUEST message the mobile station shall start timer T3204. If the mobile station receives a PACKET DOWNLINK ASSIGNMENT message before expiry of timer T3204, the mobile station shall ignore the message;
  - If the purpose of the packet access procedure is to send an MBMS SERVICE REQUEST message to the network, the mobile station shall indicate 'Single block MBMS access' in the PACKET CHANNEL REQUEST message.

EGPRS TBF mode capable mobile stations shall monitor the GPRS Cell Options IE on the PBCCH (PSI1/PSI13) for the cell's EGPRS capability and, if the mobile station is also Reduced Latency capable, the cell's Reduced Latency Access capability. In the GPRS Cell Options IE it is also indicated if the EGPRS PACKET CHANNEL REQUEST message is supported in the cell and if Reduced Latency Access is supported in the cell. If the mobile station supports the IMMEDIATE PACKET ASSIGNMENT message, the mobile station shall monitor cell's capability for IMMEDIATE PACKET ASSIGNMENT message within paging messages received on its own paging sub-channel. The following table specifies which message and which access type shall be used by an EGPRS mobile station when accessing an EGPRS capable cell depending on the purpose of the packet access procedure, and mobile station's and cell's capabilities; this table covers the case where PBCCH is present in the cell (see 3GPP TS 44.018 for the case where PBCCH is not present in the cell). The network shall not indicate Reduced Latency Access is supported if the EGPRS PACKET CHANNEL REQUEST message is not indicated as supported. The network shall not indicate IMMEDIATE PACKET ASSIGNMENT message is supported if the EGPRS PACKET CHANNEL REQUEST message is not indicated as supported.

Table 7.1.2.1.1: EGPRS PACKET CHANNEL REQUEST support

Purpose of the packet access procedure	EGPRS PACKET CHANNEL REQUEST supported in the cell	EGPRS PACKET CHANNEL REQUEST not supported in the cell
User data transfer - requested RLC mode = unacknowledged	EGPRS PACKET CHANNEL REQUEST with access type = 'Two Phase Access Request'	PACKET CHANNEL REQUEST with access type = 'Two Phase Access Request' (NOTE 1)
User data transfer - requested RLC mode = acknowledged	EGPRS PACKET CHANNEL REQUEST with access type = 'One Phase Access Request' or 'Two Phase Access Request'	PACKET CHANNEL REQUEST with access type = 'Two Phase Access Request' (NOTE 1)
User data transfer - requested RLC mode = acknowledged (Reduced Latency supported by MS)	EGPRS PACKET CHANNEL REQUEST with access type = 'One Phase Access Request by Reduced Latency MS' (NOTE 3)	PACKET CHANNEL REQUEST with access type = 'Two Phase Access Request' (NOTE 1)
Upper layer signalling transfer (e.g. page response, cell update, MM signalling, etc)	EGPRS PACKET CHANNEL REQUEST with access type = 'Signalling'	PACKET CHANNEL REQUEST with access type = 'Two Phase Access Request'
Sending of a measurement report or of a PACKET CELL CHANGE FAILURE	PACKET CHANNEL REQUEST with access type = 'Single block without TBF establishment' (NOTE 1)	
Sending of a PACKET PAUSE message	PACKET CHANNEL REQUEST with access type = 'Single block without TBF establishment' (NOTE 1) (NOTE 2)	
Sending of an MBMS Service Request message	PACKET CHANNEL REQUEST with access type = 'Single block MBMS access' (NOTE 1)	
NOTE 1: The format to be used for the PACKET CHANNEL REQUEST message is defined by the parameter ACCESS_BURST_TYPE.		
NOTE 2: Upon the first attempt to send a PACKET CHANNEL REQUEST message the mobile station shall start timer T3204. If the mobile station receives a PACKET DOWNLINK ASSIGNMENT message before expiry of timer T3204, the mobile station shall ignore the message.		
NOTE 3: The 'One phase Access Request by Reduced Latency MS' shall be used by the mobile station supporting reduced latency if Reduced Latency Access is supported by the network.		

#### 7.1.2.1.1 Access persistence control on PRACH

The mobile station shall make maximally  $M + 1$  attempts to send a PACKET CHANNEL REQUEST (respectively EGPRS PACKET CHANNEL REQUEST) message.

After sending each PACKET CHANNEL REQUEST (respectively EGPRS PACKET CHANNEL REQUEST) message, the mobile station shall listen to the full PCCCH corresponding to its PCCCH\_GROUP.

The PRACH Control Parameters IE contains the access persistence control parameters and shall be broadcast on PBCCH and PCCCH. The parameters included in the PRACH Control Parameters IE are:

- MAX\_RETRANS, for each radio priority  $i$  ( $i = 1, 2, 3, 4$ );
- PERSISTENCE\_LEVEL, which consists of the PERSISTENCE\_LEVEL  $P(i)$  for each radio priority  $i$  ( $i = 1, 2, 3, 4$ ); where  $P(i) \in \{0, 1, \dots, 14, 16\}$ . If the PRACH Control Parameters IE does not contain the PERSISTENCE\_LEVEL parameter, this shall be interpreted as if  $P(i) = 0$  for all radio priorities;
- S;
- TX\_INT.

The mobile station shall start timer T3186 at the beginning of the packet access procedure. At expiry of timer T3186, the packet access procedure shall be aborted, and:

- if at least one PACKET CHANNEL REQUEST (respectively EGPRS PACKET CHANNEL REQUEST) message was transmitted by the mobile station, a random access failure shall be indicated to upper layers and the mobile station shall perform autonomous cell re-selection according to 3GPP TS 43.022;
- otherwise, a packet access failure shall be indicated to upper layers and the mobile station shall return to packet idle mode or MAC-Idle state.

The first attempt to send a PACKET CHANNEL REQUEST (respectively EGPRS PACKET CHANNEL REQUEST) message, may be initiated at the first available PRACH block on the PDCH defined by the PCCCH\_GROUP for the

mobile station (see 3GPP TS 45.002). The mobile station shall choose one of the four TDMA frames within the selected PRACH block randomly with a uniform probability distribution.

For each attempt, the mobile station shall draw a random value  $R$  with uniform probability distribution in the set  $\{0, 1, \dots, 15\}$ . The mobile station is allowed to transmit a PACKET CHANNEL REQUEST (respectively EGPRS PACKET CHANNEL REQUEST) message if  $P(i)$ , where  $i$  is the radio priority of the TBF being established, is less than or equal to  $R$ .

After each attempt, the  $S$  and  $T$  parameters are used to determine the next TDMA frame in which it may be allowed to make a successive attempt. The number of TDMA frames belonging to the PRACH on the PDCH defined by the PCCCH\_GROUP for the mobile station between two successive attempts to send a PACKET CHANNEL REQUEST (respectively EGPRS PACKET CHANNEL REQUEST) message excluding the TDMA frames potentially containing the messages themselves is a random value drawn for each transmission with uniform probability distribution in the set  $\{S, S + 1, \dots, S + T - 1\}$ .

Here:

$M$  is the value of the parameter MAX\_RETRANS, belonging to the Radio Priority of the access;

$T$  is the value of the parameter TX\_INT;

$S$  is the value of the parameter  $S$ .

Having made  $M + 1$  attempts to send a PACKET CHANNEL REQUEST (respectively EGPRS PACKET CHANNEL REQUEST) message, the mobile station shall stop timer T3186 and start timer T3170 if at least one PACKET CHANNEL REQUEST (respectively EGPRS PACKET CHANNEL REQUEST) message was transmitted by the mobile station. In this case, at expiry of timer T3170, the packet access procedure shall be aborted, a random access failure shall be indicated to upper layers and the mobile station shall perform autonomous cell re-selection according to 3GPP TS 43.022. Otherwise, the packet access procedure shall be aborted, a packet access failure shall be indicated to upper layers and the mobile station shall return to packet idle mode or MAC-Idle state.

If the mobile station receives a PACKET DOWNLINK ASSIGNMENT message while it is waiting for a response to a PACKET CHANNEL REQUEST (respectively EGPRS PACKET CHANNEL REQUEST) message, it shall abort the packet access procedure and respond to the PACKET DOWNLINK ASSIGNMENT message (see sub-clause 7.2.1). The mobile station shall then attempt establishment of an uplink TBF using the procedures defined in sub-clause 8.1.2.5.

## 7.1.2.2 Packet assignment procedure

### 7.1.2.2.1 On receipt of a PACKET CHANNEL REQUEST or EGPRS PACKET CHANNEL REQUEST message

On receipt of a PACKET CHANNEL REQUEST message, the network may assign a radio resource on one or more PDCHs to be used by the mobile station for the TBF in GPRS TBF mode. On receipt of an EGPRS PACKET CHANNEL REQUEST message, the network may assign a radio resource on one or more PDCHs to be used by the mobile station for the TBF in EGPRS TBF mode or GPRS TBF mode.

The allocated PDTCH and PACCH resource is assigned to the mobile station in a PACKET UPLINK ASSIGNMENT message, sent on any PAGCH block on the same PCCCH on which the network has received the PACKET CHANNEL REQUEST or EGPRS PACKET CHANNEL REQUEST message. The *Packet Request Reference* information element shall be used to address the mobile station and frequency parameters shall be included.

A mobile station supporting Downlink Dual Carrier may be sent a PACKET UPLINK ASSIGNMENT message to assign radio resources on two different radio frequency channels for a given uplink TBF. In such a configuration, uplink radio blocks shall not be allocated on both radio frequency channels during any given radio block period.

The mobile station may use information received on PBCCH, BCCH or a previous assignment message to decode the frequency parameters contained in the assignment message. If the mobile station detects an invalid *Frequency Parameters* information element or an invalid *Dual Carrier Frequency Parameters* information element in the assignment message, it shall abort the procedure, if required initiate a partial acquisition of PBCCH or BCCH information, and may then re-initiate this procedure.

If the dynamic allocation medium access mode is commanded, the network shall include the USF values allocated for PDCHs in the PACKET UPLINK ASSIGNMENT message.

Unless the mobile station has indicated a "Single Block Without TBF Establishment" or "Single block MBMS access" in a PACKET CHANNEL REQUEST message, the mobile station shall perform a two phase access if the PACKET UPLINK ASSIGNMENT message includes a Single Block Allocation struct or a Multi Block Allocation struct.

If the PACKET UPLINK ASSIGNMENT message includes Dynamic Allocation struct and the MS has not requested "Single Block Without TBF Establishment", "Two phase access", or "Single Block MBMS access", the mobile station shall perform a one phase access.

In case the MS requested two phase access, the procedures in sub-clause 7.1.3 shall apply.

A mobile station that has indicated "Single Block Without TBF Establishment" in the PACKET CHANNEL REQUEST message for the purpose of sending a measurement report shall send a measurement report according to sub-clause 7.3.1.

A mobile station that has indicated "Single Block Without TBF Establishment" in the PACKET CHANNEL REQUEST message for the purpose of sending a PACKET CELL CHANGE FAILURE message shall send that message according to sub-clause 8.4.2.

On receipt of a PACKET UPLINK ASSIGNMENT message corresponding to one of its 3 last PACKET CHANNEL REQUEST or EGPRS PACKET CHANNEL REQUEST messages the mobile station shall stop timers T3186 and T3170 if running and stop sending PACKET CHANNEL REQUEST or EGPRS PACKET CHANNEL REQUEST messages.

If the PACKET UPLINK ASSIGNMENT message does not specify a TBF starting time, the mobile station shall switch to the assigned PDCHs, start timer T3164 if dynamic or extended dynamic allocation is assigned and proceed with contention resolution of the one phase packet access procedure according to sub-clause 7.1.2.3 (*A/Gb mode*) or 3GPP TS 44.160 (*Iu-mode*) or in case of EGPRS, sub-clause 7.1.2.3a (*A/Gb mode*) or 3GPP TS 44.160 (*Iu-mode*).

Unless assigning resources for RTTI, dual carrier, BTTI with FANR activated or EGPRS2 configurations, a PACKET UPLINK ASSIGNMENT message may indicate an assignment starting time in the TBF Starting Time parameter. The mobile station shall monitor the full PCCCH until the point in time denoted by the TBF Starting Time. Thereafter it shall switch to the assigned PDCHs. If dynamic or extended dynamic allocation is assigned, the mobile station shall start timer T3164. Regardless of which allocation mode is used, the mobile station shall proceed with the contention resolution defined in sub-clause 7.1.2.3 (*A/Gb mode*) or 3GPP TS 44.160 (*Iu-mode*) or in case of EGPRS, sub-clause 7.1.2.3a (*A/Gb mode*) or 3GPP TS 44.160 (*Iu-mode*). If the mobile station receives more than one PACKET UPLINK ASSIGNMENT message, it shall act upon the most recently received message and shall ignore the previous message.

When the mobile station switches to the assigned PDCHs, it shall take the power control parameters received in the PACKET UPLINK ASSIGNMENT message into account, perform signal strength measurements and apply output power control procedures as they are defined for packet transfer mode or MAC-Shared state (see 3GPP TS 45.008).

On receipt of a PACKET CHANNEL REQUEST message with establishment cause indicating "Two Phase Access Request", "Single block without TBF establishment" or "Single block MBMS access", the network may allocate a single radio block on an uplink PDCH. In order to force the mobile station to make a two phase access, the network may allocate a single radio block on an uplink PDCH on receipt of a PACKET CHANNEL REQUEST message with any of the other access types.

On receipt of an EGPRS PACKET CHANNEL REQUEST message with establishment cause indicating "Two Phase Access Request", the network may allocate a Multi Block allocation on an uplink PDCH. In order to force the mobile station to make a two phase access, the network may allocate a Multi Block allocation on an uplink PDCH on receipt of a EGPRS PACKET CHANNEL REQUEST message with any of the other access types.

If the mobile station has been allocated a single block (respectively a Multi Block allocation) in the PACKET UPLINK ASSIGNMENT message and the mobile station has not indicated "Single block without TBF establishment" (respectively "Two phase access") in the PACKET CHANNEL REQUEST (respectively EGPRS PACKET CHANNEL REQUEST) message or "Single block MBMS access" in the PACKET CHANNEL REQUEST message, the mobile station shall proceed with the two phase packet access procedure according to sub-clause 7.1.3 (*A/Gb mode*) or 3GPP TS 44.160 (*Iu-mode*).

If the mobile station has been allocated a single block in the PACKET UPLINK ASSIGNMENT message and the purpose of the packet access procedure is to send a Measurement Report message and the mobile station has indicated "Single block without TBF establishment" in the PACKET CHANNEL REQUEST message, the mobile station shall proceed according to sub-clause 7.3.1.

If the mobile station has been allocated a single block in the PACKET UPLINK ASSIGNMENT message and the purpose of the packet access procedure is to send a PACKET PAUSE message and the mobile station has indicated "Single block without TBF establishment" in the PACKET CHANNEL REQUEST message, the mobile station shall proceed according to sub-clause 7.6.

If the mobile station has been allocated a single block in the PACKET UPLINK ASSIGNMENT message and the purpose of the packet access procedure is to send an MBMS SERVICE REQUEST message and the mobile station has indicated "Single block MBMS access" in the PACKET CHANNEL REQUEST message, the mobile station shall proceed according to sub-clause 7.7.1.2.2.

#### 7.1.2.2.1a Acquisition of MS Radio Access Capability information within EGPRS TBF establishment procedure

When assigning an EGPRS TBF, the network may request information about radio access capabilities of the mobile station on one or several frequency bands within the PACKET UPLINK ASSIGNMENT message; the list of frequency bands is ordered by the network starting with the most important and ending with the least important one. The mobile station shall provide the network with its radio access capabilities for the frequency bands it supports, in the same priority order as the one specified by the network, by sending a PACKET RESOURCE REQUEST message, and an ADDITIONAL MS RADIO ACCESS CAPABILITIES message if all the requested information does not fit in the PACKET RESOURCE REQUEST. If the mobile station does not support any frequency band requested by the network, it shall report its radio access capabilities for the BCCH frequency band. The mobile station shall indicate in the PACKET RESOURCE REQUEST if it will send more information about its radio access capabilities in the ADDITIONAL MS RADIO ACCESS CAPABILITIES message. The PACKET RESOURCE REQUEST and the ADDITIONAL MS RADIO ACCESS CAPABILITIES messages shall be sent within the one or two first radio blocks allocated for the mobile station on the assigned PDCH. The mobile station shall include the TLLI in these two messages until contention resolution. After that, the mobile station may use either the uplink TFI or the TLLI when these messages are repeated.

When constructing the PACKET RESOURCE REQUEST and ADDITIONAL MS RADIO ACCESS CAPABILITIES messages the mobile station shall take care that these messages fit in one UL radio block each. See sub-clause 12.30 for additional restrictions regarding how information for a given access technology type is to be provided using these messages.

The network may request a retransmission of the PACKET RESOURCE REQUEST and the ADDITIONAL MS RADIO ACCESS CAPABILITIES messages. A request for retransmission of one or both of these messages shall be indicated in the PACKET UPLINK ACK/NACK or the PACKET UPLINK ASSIGNMENT message. The mobile station has to indicate within the PACKET RESOURCE REQUEST message if the message is a retransmitted one. For the case of message retransmission the most recently sent instance of these messages shall be retransmitted. If these messages have not already been sent by the MS during the establishment (two phase access) or after the establishment (one phase access) of the corresponding uplink TBF then the request shall be ignored.

#### 7.1.2.2.2 Packet access queuing notification procedure

The network may send to the mobile station a PACKET QUEUING NOTIFICATION message. The PACKET QUEUING NOTIFICATION message shall be sent on the same PCCCH on which the network has received the PACKET CHANNEL REQUEST or EGPRS PACKET CHANNEL REQUEST message. It contains a Temporary Queuing Identity which is later used to identify the mobile station (either when polling or sending an assignment).

On receipt of a PACKET QUEUING NOTIFICATION message corresponding to one of its 3 last PACKET CHANNEL REQUEST or EGPRS PACKET CHANNEL REQUEST messages, the mobile station shall stop timers T3170 and T3186 if running, start timer T3162, and stop sending PACKET CHANNEL REQUEST or EGPRS PACKET CHANNEL REQUEST messages. It shall continue to listen to the full PCCCH corresponding to its PCCCH\_GROUP. If the mobile station receives a PACKET QUEUING NOTIFICATION message while waiting for the TBF Starting Time of a valid PACKET UPLINK ASSIGNMENT message, the mobile station shall ignore the PACKET QUEUING NOTIFICATION message.

The network may send to the mobile station a PACKET UPLINK ASSIGNMENT message following a PACKET QUEUING NOTIFICATION message. In this case, the reference address to the mobile station shall be the Temporary Queuing Identity received in the PACKET QUEUING NOTIFICATION message.

On receipt of a PACKET UPLINK ASSIGNMENT message following a PACKET QUEUING NOTIFICATION message, the mobile station shall stop timer T3162 and follow the procedures defined in sub-clause 7.1.2.2.1.

At expiry of timer T3162, the packet access procedure shall be aborted and a packet access failure shall be indicated to the upper layer and the mobile station shall return to packet idle mode or MAC-Idle state.

If the mobile station receives a PACKET DOWNLINK ASSIGNMENT message, it shall abort the packet access queuing notification procedure and respond to the PACKET DOWNLINK ASSIGNMENT message (see sub-clause 7.2.1). The mobile station shall then attempt establishment of an uplink TBF using the procedures defined in sub-clause 8.1.2.5.

#### 7.1.2.2.3 Packet polling procedure

The network may send to the mobile station a PACKET POLLING REQUEST message after having sent a PACKET QUEUING NOTIFICATION message. The PACKET POLLING REQUEST message shall be sent on the same PDCH on which the network has received the PACKET CHANNEL REQUEST or EGPRS PACKET CHANNEL REQUEST message. The mobile station shall be addressed by the Temporary Queuing Identity.

On receipt of a PACKET POLLING REQUEST message, the mobile station shall respond to the network with the PACKET CONTROL ACKNOWLEDGEMENT message in the reserved uplink radio block specified by the RRBP field. The reserved block is considered as a one block PACCH allocation.

#### 7.1.2.2.4 Packet access reject procedure

The network may, as response to a PACKET CHANNEL REQUEST or EGPRS PACKET CHANNEL REQUEST message, send to the mobile station a PACKET ACCESS REJECT message on any PAGCH block on the same PCCCH on which the channel request message was received. This message contains the request reference with time of reception of the PACKET CHANNEL REQUEST or EGPRS PACKET CHANNEL REQUEST message and optionally a WAIT\_INDICATION field in the Reject structure of the PACKET ACCESS REJECT message.

On receipt of a PACKET ACCESS REJECT message containing a Reject structure addressed to the mobile station, where the Packet Request Reference in the Reject structure corresponds to one of its 3 last PACKET CHANNEL REQUEST or EGPRS PACKET CHANNEL REQUEST messages:

- The mobile station shall stop timer T3186, stop sending PACKET CHANNEL REQUEST or EGPRS PACKET CHANNEL REQUEST messages, start timer T3172 with the value indicated in the WAIT\_INDICATION field, start timer T3170 if it has not already been started and listen to the downlink PCCCH until timer T3170 expires. During this time, the mobile station shall ignore additional PACKET ACCESS REJECT messages, but on reception of any PACKET UPLINK ASSIGNMENT message corresponding to any other of its 3 last PACKET CHANNEL REQUEST or EGPRS PACKET CHANNEL REQUEST messages the mobile station shall stop timers T3170 and T3172 if running, and follow the procedure defined in sub-clause 7.1.2.2.1;
- If no PACKET UPLINK ASSIGNMENT message is received before expiration of timer T3170, the mobile station shall indicate a packet access failure to upper layer and return to packet idle mode (listening to its paging channel). As an option the mobile station may stop timer T3170, indicate a packet access failure to upper layer and return to packet idle mode as soon as it has received responses from the network on all or, in case more than 3 were sent, the last 3 of its PACKET CHANNEL REQUEST or EGPRS PACKET CHANNEL REQUEST messages;
- If an erroneous PACKET UPLINK ASSIGNMENT message (e.g. the mobile station has been assigned more PDCHs than it supports according to the relevant multislot configuration as defined in 3GPP TS 45.002) addressed to the mobile station is received before expiration of timer T3170, the mobile station shall stop T3170 and act as stated in sub-clause 7.1.4;
- If the mobile station receives a PACKET DOWNLINK ASSIGNMENT message, it shall stop timer T3170 if running and respond to the PACKET DOWNLINK ASSIGNMENT message (see sub-clause 7.2.1);
- The mobile station is not allowed to make a new attempt for packet access in the same cell until timer T3172 expires, but may attempt packet access in another cell after successful cell reselection for radio conditions

reasons (see 3GPP TS 45.008). In *A/Gb mode*, a mobile station that is IMSI attached (GPRS class A or B mode of operation) may attempt to enter the dedicated mode in the same cell before timer T3172 has expired. During the time T3172 is running, the mobile station shall ignore all received PACKET PAGING REQUEST messages except paging requests sent to trigger RR connection establishment and paging requests sent to trigger the acquisition of an ETWS Primary Notification message;

- The value of the WAIT\_INDICATION field (i.e. timer T3172) relates to the cell from which it was received.

### 7.1.2.3 Contention resolution at one phase access

The TLLI is used to uniquely identify the mobile station when sending on uplink. Every RLC data block that is sent on the TBF shall include the TLLI of the mobile station, until the contention resolution is completed on the mobile station side. If MCS-7, MCS-8 or MCS-9 is used for the transmission of the TLLI in EGPRS TBF mode (i.e. the RLC/MAC block is carrying two RLC data blocks), the TLLI shall be inserted in both RLC data blocks. The TLLI shall also be included in the PACKET RESOURCE REQUEST and the ADDITIONAL MS RADIO ACCESS CAPABILITIES messages, if those are sent during the contention resolution.

The retransmission of an RLC data block shall include the TLLI (or the TLLI and the PFI field), if the RLC data block was originally transmitted including these fields, also if the retransmission occurs after the completion of the contention resolution.

At sending of the first RLC data block, the mobile station shall stop timer T3164, set counter N3104 to 1, and start timer T3166. The counter N3104 shall be stepped each time the mobile station sends an RLC/MAC block for data transfer.

The network shall respond by including the TLLI in the PACKET UPLINK ACK/NACK message after the first correctly received RLC data block that comprises the TLLI. In EGPRS TBF mode, the network may instead respond by addressing the mobile station with the TFI of the assigned TBF and including the TLLI (in the CONTENTION\_RESOLUTION\_TLLI field) in a PACKET UPLINK ASSIGNMENT message, if the resources allocated for the TBF need to be reallocated (see sub-clause 8.1.1.1.2).

The contention resolution is completed on the network side when the network receives an RLC data block that comprises the TLLI value that identifies the mobile station and the TFI value associated with the TBF.

The contention resolution is successfully completed on the mobile station side when the mobile station receives a PACKET UPLINK ACK/NACK message addressing the mobile station with the TFI value associated with the uplink TBF and including the same TLLI value that the mobile station has included in the RLC header of the first RLC data blocks, or alternatively, in EGPRS TBF mode, a PACKET UPLINK ASSIGNMENT message addressing the mobile station with the TFI value associated with the uplink TBF and including the same TLLI value that the mobile station included in the RLC header of the first RLC data blocks. The mobile shall then stop timer T3166 and counter N3104.

The contention resolution has failed on the mobile station side when the counter N3104 reaches its maximum value, or timer T3166 expires. The contention resolution also fails, if the mobile station receives a PACKET UPLINK ACK/NACK message or in EGPRS TBF mode alternatively a PACKET UPLINK ASSIGNMENT message addressing the mobile station with the TFI associated with the uplink TBF and including a TLLI value other than that the mobile station included in the RLC header of the first RLC data blocks; in such a case, the mobile station shall not transmit a PACKET CONTROL ACKNOWLEDGEMENT in the uplink radio block specified if a valid RRBP field is received as part of the PACKET UPLINK ACK/NACK message or in EGPRS TBF mode alternatively as part of the PACKET UPLINK ASSIGNMENT message.

In case of a contention resolution failure on the mobile station side, the mobile station shall reset the counter N3104 and stop timer T3166, if not expired. The mobile station shall stop transmitting on the TBF and reinitiate the packet access procedure, unless the packet access procedure has already been attempted four times. In that case, a TBF failure has occurred, see sub-clause 7.1.4.

#### 7.1.2.3a RLC/MAC procedures during contention resolution

During the contention resolution, the mobile station may receive a non-distribution RLC/MAC control message addressing the mobile station by TLLI, or the TFI value associated with the uplink TBF. The mobile station shall act on that message using the procedure defined for the message when it is received in packet transfer mode during operation on an uplink TBF (see clause 8), with the following restrictions:



- The mobile station shall not accept a PACKET MEASUREMENT ORDER message, a PACKET CELL CHANGE ORDER message and a PACKET POWER CONTROL/TIMING ADVANCE message addressing the mobile station with the TFI value associated with the uplink TBF;
- The mobile station shall not accept a PACKET DOWNLINK ASSIGNMENT or a PACKET TIMESLOT RECONFIGURE message.

If a valid RRBP field is received as part of the RLC/MAC control block, the mobile station shall transmit a PACKET CONTROL ACKNOWLEDGEMENT message in the uplink radio block specified (see sub-clause 10.4.5) if it acts on the message; the mobile station may transmit a PACKET CONTROL ACKNOWLEDGEMENT message in the uplink radio block specified if it does not act on the message.

If during the contention resolution, upper layers request the transfer of another upper layer PDU with a different PFI, a different Radio Priority, a different peak throughput class or a different RLC mode than the one which is in transfer, then the procedures as described in packet transfer mode (see sub-clause 8.1.1.1.2) shall be applied by the mobile station.

In either case, the mobile station shall continue with the contention resolution on the uplink TBF, till it either completes successfully or fails, or that the uplink TBF is released as a result of the procedure defined for the message that is received.

#### 7.1.2.4 One phase packet access completion

The one phase packet access procedure is completed upon a successful contention resolution. The mobile station has entered the packet transfer mode or MAC-Shared state.

#### 7.1.2.5 Timing Advance

Initial timing advance may be provided in the PACKET UPLINK ASSIGNMENT in the TIMING\_ADVANCE\_VALUE field.

Thereafter either the timing advance is updated with a PACKET POWER CONTROL/TIMING ADVANCE message or a continuous timing advance procedure is used. If a Timing Advance Index is included in the assignment message, the mobile station shall use the continuous timing advance procedure, using its allocation on PTCCH (see 3GPP TS 45.010). Otherwise, the continuous timing advance procedure shall not be used. For the case where a TIMING\_ADVANCE\_VALUE field is not provided in the assignment message, the mobile station is not allowed to send normal bursts on the uplink until it receives a valid timing advance either through the continuous timing advance procedure or in a PACKET POWER CONTROL/TIMING ADVANCE message.

In the case of a mobile station with a Downlink Dual Carrier configuration where the continuous timing advance procedure is used there is no explicit indication of the carrier on which the PTCCH is allocated, and the mobile station shall consider the PTCCH allocation to be on carrier 1 (see sub-clause 5.5.1.7). If a mobile station with a Downlink Dual Carrier configuration subsequently receives an assignment message which results in the mobile station no longer being in a Downlink Dual Carrier configuration (but still in packet transfer mode), the mobile station shall consider the PTCCH allocation to be on the carrier on which packet resources are assigned.

In the case of a mobile station in a DLMC configuration where the continuous timing advance procedure is used the assignment message indicates the carrier on which the PTCCH is allocated. If a mobile station in a DLMC configuration subsequently receives an assignment message that results in the mobile station no longer being in a DLMC configuration (but still in packet transfer mode), the mobile station shall consider the PTCCH allocation to be on the carrier on which packet resources are assigned.

#### 7.1.2.6 PFC procedure at one phase access

If the PFC\_FEATURE\_MODE field indicates that the network supports PFC procedures in the system information and if a PFC exists for the LLC data to be transferred then the PFI shall be transmitted along with the TLLI of the mobile station in the RLC extended header during contention resolution. If the PFC\_FEATURE\_MODE field indicates that the network does not support PFC procedures, the mobile station shall not indicate a PFI value. If no valid PFI is assigned, the default mapping defined in sub-clause 5.5.1.9 shall be used. The PFI is not used for contention resolution but is included to indicate to the network which PFC shall initially be associated with the uplink TBF.

### 7.1.3 TBF establishment using two phase access

The two phase access procedure defined in this sub-clause, is applicable also in the case when no PCCCH is provided in the cell. For that case, the first phase is defined in 3GPP TS 44.018.

#### 7.1.3.1 Initiation of the Packet resource request procedure

In the first phase of a two phase access in a cell provided with a PCCCH, the same procedures as for one phase access are used until the network sends a PACKET UPLINK ASSIGNMENT message including a Single Block Allocation struct or Multi Block Allocation struct, denoting two phase access to the mobile station. The Multi Block Allocation struct may be used only if the mobile station has EGPRS capability (i.e. the network received an EGPRS PACKET CHANNEL REQUEST message from the mobile station). In the PACKET UPLINK ASSIGNMENT message, the network reserves a limited resource on one PDCH to the mobile station where the mobile station may transmit a PACKET RESOURCE REQUEST message and optionally an ADDITIONAL MS RADIO ACCESS CAPABILITIES message.

If PCCCH is provided in the cell, a two phase access can be initiated:

- by the network by ordering the mobile station to send a PACKET RESOURCE REQUEST message. The order is sent implicitly to the mobile station in the PACKET UPLINK ASSIGNMENT message by including either the Single Block Allocation struct or Multi Block Allocation struct;
- by a mobile station, by requiring a two phase access in the PACKET CHANNEL REQUEST or EGPRS PACKET CHANNEL REQUEST message. In this case, if access is granted, the network shall order the mobile station to send a PACKET RESOURCE REQUEST message. The order is sent implicitly to the mobile station in the PACKET UPLINK ASSIGNMENT message by including the Single Block Allocation struct or Multi Block Allocation struct.

If no PCCCH is provided in the cell, a two phase access can be initiated by the network or by a mobile station, as defined in 3GPP TS 44.018.

When the mobile station has received the PACKET UPLINK ASSIGNMENT message it shall respond with a PACKET RESOURCE REQUEST message in the first allocated radio block.

A mobile station supporting EGPRS shall indicate the EGPRS capability in the MS Radio Access Capability 2 IE of the PACKET RESOURCE REQUEST message.

A mobile station supporting multiple TBF procedures shall set the Multiple TBF Capability flag in the *MS Radio Access Capability 2* IE of the PACKET RESOURCE REQUEST message.

A mobile station attempting a packet access for the purpose of *NAS signalling low priority* (see 3GPP TS 24.008) shall set the *Low Access Priority Signalling* field to "1" in the PACKET RESOURCE REQUEST message (see sub-clause 11.2.16). The *Low Access Priority Signalling* field shall be set to "0" if the PACKET RESOURCE REQUEST message is sent for any other reason and includes the *Low Access Priority Signalling* field.

When the mobile station switches to the assigned PDCH, it shall take the power control parameters received in the PACKET UPLINK ASSIGNMENT message into account, perform signal strength measurements and apply output power control procedures as they are defined for packet transfer mode (see 3GPP TS 45.008).

At sending of the PACKET RESOURCE REQUEST message requesting a single uplink TBF, the mobile station shall start timer T3168. At sending of the PACKET RESOURCE REQUEST message requesting multiple TBFs, the mobile station shall start contention resolution timer T3188 and additionally one instance of T3168 for each of the resource requests for the transfer of upper layer PDUs. Furthermore, the mobile station shall not respond to PACKET DOWNLINK ASSIGNMENT or MULTIPLE TBF DOWNLINK ASSIGNMENT messages before contention resolution is completed on the mobile station side - but may acknowledge such messages if they contain a valid RRB field.

The mobile station may indicate in the PACKET RESOURCE REQUEST message the number of octets of user data it has to transfer.

### 7.1.3.2 Packet resource assignment for uplink procedure

When assigning a Multi Block Allocation, the network may request information about radio access capabilities of the mobile station on one or several frequency bands within the PACKET UPLINK ASSIGNMENT message and allocate one or two radio blocks for uplink control messages accordingly; the list of frequency bands is ordered by the network starting with the most important and ending with the least important one. The mobile station shall provide the network with its radio access capabilities for the frequency bands it supports, in the same order of priority as specified by the network, by sending a PACKET RESOURCE REQUEST message in the first radio block on the assigned PDCH and an ADDITIONAL MS RADIO ACCESS CAPABILITIES message in the next radio block on the assigned PDCH, if the requested information does not fit in the PACKET RESOURCE REQUEST and two radio blocks have been allocated by the network. If the network does not provide an Access Technologies Request in the PACKET UPLINK ASSIGNMENT message or the mobile station does not support any frequency band requested by the network, it shall report its radio access capabilities for the frequency band of the BCCH carrier in the PACKET RESOURCE REQUEST message.

The mobile station shall indicate in the PACKET RESOURCE REQUEST message, by setting the ADDITIONAL MS RAC INFORMATION AVAILABLE bit, if it will send more information about its radio access capabilities in the ADDITIONAL MS RADIO ACCESS CAPABILITIES message if it has been allocated two radio blocks, or if it would have sent more information but has been allocated only one radio block. If the mobile station has been allocated two radio blocks and the requested information fit in the PACKET RESOURCE REQUEST message, no ADDITIONAL MS RADIO ACCESS CAPABILITIES message shall be sent. Instead, some uplink control block (e.g. packet measurement report, packet uplink dummy control block) may be sent by the mobile station.

The network may indicate in the next PACKET UPLINK ASSIGNMENT or MULTIPLE TBF UPLINK ASSIGNMENT message a request for retransmission of the ADDITIONAL MS RADIO ACCESS CAPABILITIES message (see sub-clause 7.1.3.2.1).

When constructing the PACKET RESOURCE REQUEST and ADDITIONAL MS RADIO ACCESS CAPABILITIES messages the mobile station shall take care that these messages fit in one uplink radio block each (see sub-clause 7.1.2.2.1a).

If the network indicates that it supports packet flow procedures via the PFC\_FEATURE\_MODE in the system information, then the mobile station supporting PFC procedures shall indicate the initial PFI to be associated with the TBF in the PACKET RESOURCE REQUEST message. If the PFC\_FEATURE\_MODE field indicates that the network does not support PFC procedures, the mobile station shall not indicate a PFI value. If no valid PFI is assigned, the default mapping defined in sub-clause 5.5.1.9 shall be used. If the mobile station requests multiple TBFs in the PACKET RESOURCE REQUEST message, it shall indicate the PFI to be associated with each TBF.

Whenever the mobile station wants to pre-allocate an uplink TBF, it shall send a PACKET RESOURCE REQUEST message with the EARLY\_TBF\_ESTABLISHMENT field set to indicate pre-allocation is required.

#### 7.1.3.2.1 On receipt of a PACKET RESOURCE REQUEST message

On receipt of a PACKET RESOURCE REQUEST message requesting a single uplink TBF scheduled with a Single Block or a Multi Block allocation, the network shall respond by sending a PACKET UPLINK ASSIGNMENT message (radio resources assignment on one or more PDCHs to be used by the mobile station for the TBF in EGPRS or GPRS TBF mode) or a PACKET ACCESS REJECT message to the mobile station on PACCH on the same PDCH on which the mobile station has sent the PACKET RESOURCE REQUEST message. If the mobile station supports RLC non-persistent mode the network may allocate an EGPRS TBF that uses this RLC mode.

On receipt of a PACKET RESOURCE REQUEST message requesting multiple uplink TBFs, the network shall respond by sending either a MULTIPLE TBF UPLINK ASSIGNMENT message or a PACKET ACCESS REJECT message to the mobile station on PACCH on the same PDCH on which the mobile station has sent the PACKET RESOURCE REQUEST message. These messages shall address (assign or reject) some or all of the resource requests in the PACKET RESOURCE REQUEST message. For the resource requests that have not been addressed by the first assignment or reject message, additional MULTIPLE TBF UPLINK ASSIGNMENT or PACKET ACCESS REJECT messages may be sent to the mobile station on the PACCH to which the mobile station has been assigned. If the mobile station supports RLC non-persistent mode the network may allocate one or more EGPRS TBFs that use this RLC mode.

If the received PACKET RESOURCE REQUEST message is indicating additional MS Radio Access Capabilities information available, the following additional requirements apply:

- If the PACKET RESOURCE REQUEST message was scheduled with a Multi Block allocation of two blocks, the network shall respond by sending a PACKET UPLINK ASSIGNMENT or MULTIPLE TBF UPLINK ASSIGNMENT message after reception of the ADDITIONAL MS RADIO ACCESS CAPABILITIES message;
- If the PACKET RESOURCE REQUEST message was scheduled with a Single Block allocation or with a Multi Block allocation of only one block, the network shall respond upon receipt by sending a PACKET UPLINK ASSIGNMENT or MULTIPLE TBF UPLINK ASSIGNMENT message. When assigning one or more EGPRS TBFs, the network may request additional information about radio access capabilities of the mobile station on one or several frequency bands within the PACKET UPLINK ASSIGNMENT or MULTIPLE TBF UPLINK ASSIGNMENT message; the list of frequency bands is ordered by the network starting with the most important and ending with the least important one. The mobile station shall provide the network with its radio access capabilities for the frequency bands it supports, in the same priority order as the one specified by the network, by sending an ADDITIONAL MS RADIO ACCESS CAPABILITIES message within the first radio block allocated to the mobile station on the assigned PDCH(s). When constructing the ADDITIONAL MS RADIO ACCESS CAPABILITIES message, the mobile station shall take care that this message fits in one uplink radio block (see sub-clause 7.1.2.2.1a). If the mobile station does not support any frequency band requested by the network, it shall report its radio access capabilities for the BCCH frequency band.

In case the ADDITIONAL MS RADIO ACCESS CAPABILITIES message is not received correctly, the network may either:

- send a PACKET UPLINK ASSIGNMENT or MULTIPLE TBF UPLINK ASSIGNMENT message assigning radio resources on one or more PDCHs to be used by the mobile station for the TBF(s) in EGPRS or GPRS TBF mode, based on the information the network has got, or let unchanged the already assigned PDCH(s);
- send a PACKET UPLINK ASSIGNMENT message assigning (or reassigning) radio resources on one or more PDCHs to be used by the mobile station for the TBF(s) in EGPRS TBF mode and request a retransmission of the ADDITIONAL MS RADIO ACCESS CAPABILITIES message.

In addition, in case the ADDITIONAL MS RADIO ACCESS CAPABILITIES message scheduled with a Multi Block allocation of two blocks is not received correctly, the network may either:

- send a PACKET UPLINK ASSIGNMENT or MULTIPLE TBF UPLINK ASSIGNMENT message including a Multi Block allocation struct (allocating only one block) requesting a retransmission of the ADDITIONAL MS RADIO ACCESS CAPABILITIES message;
- send a PACKET ACCESS REJECT message to the mobile station.

On receipt of a PACKET UPLINK ASSIGNMENT or MULTIPLE TBF UPLINK ASSIGNMENT message where no TBF starting time is specified, the mobile station shall switch to the assigned PDCHs, stop T3168 for each resource request that is assigned a TBF in the PACKET UPLINK ASSIGNMENT or MULTIPLE TBF UPLINK ASSIGNMENT message, and start timer T3164 for each allocated TBF if dynamic or extended dynamic allocation is assigned. If a TBF starting time is specified the mobile station shall stop T3168 for each resource request assigned a TBF and wait until the indicated TBF starting time before switching to the assigned PDCHs and starting T3164 for each allocated TBF.

At sending of the first RLC data block on a TBF, the mobile station shall stop timer T3164 for that TBF.

The mobile station may use information received on PBCCH, BCCH or a previous assignment message to decode the frequency parameters contained in the assignment message. If the mobile station detects an invalid Frequency Parameters information element in the assignment message, it shall abort the procedure, if required initiate a *partial acquisition* of PBCCH or BCCH information, and may then re-initiate the access on the PRACH.

On receipt of a PACKET ACCESS REJECT message that contains a Reject structure addressed to the mobile station, the mobile station shall stop timer T3168 and indicate a packet access failure to upper layer for each resource request which is rejected in the Reject structure.

If the PACKET ACCESS REJECT message contains a WAIT\_INDICATION field in a Reject structure addressed to the mobile station, the mobile station shall start timer T3172 with the indicated value (Wait Indication). The mobile station is not allowed to make a new attempt for packet access in the same cell until timer T3172 expires, but may attempt packet access in another cell after successful cell reselection.

When the network receives a Packet Flow Identifier (PFI) from the mobile then the network should handle the uplink transfer according to the associated aggregate BSS QoS profile (ABQP). The Peak Throughput specified in the associated ABQP, available in the network, supersedes the Peak Throughput specified by the Channel Request Description IE.

When an uplink TBF is established in response to a PACKET RESOURCE REQUEST message with the EARLY\_TBF\_ESTABLISHMENT field set to indicate pre-allocation is required, a network supporting early TBF establishment should keep the uplink TBF open by means of the extended uplink TBF mode operation (see sub-clause 9.3.1b.2).

### 7.1.3.3 Contention resolution at two phase access

The contention resolution is completed on the network side when the network receives a TLLI value identifying the mobile station, as part of the contention resolution procedure on the TBF.

The contention resolution is completed on the mobile station side when the mobile station receives a PACKET UPLINK ASSIGNMENT, MULTIPLE TBF UPLINK ASSIGNMENT or PACKET ACCESS REJECT message with the same TLLI as the mobile station has included in the PACKET RESOURCE REQUEST and ADDITIONAL MS RADIO ACCESS CAPABILITIES messages that addresses at least one TBF for which resources were requested in the PACKET RESOURCE REQUEST message.

- If the mobile station receives an assignment for its single uplink TBF request, it shall then stop timer T3168. It does not include its TLLI in any RLC data block;
- If the mobile station receives an assignment for at least one TBF of a multiple uplink TBF request, it shall then stop timer T3188 and the instance of T3168 which was started for the assigned TBF. It does not include its TLLI in any RLC data block.

After contention resolution is successfully completed on the mobile station side, if the mobile station requested multiple uplink TBFs and an instance of timer T3168 expires, TBF establishment for the corresponding upper layer PDU has failed. The mobile station shall reinitiate a resource request for that upper layer PDU using the procedures described in sub-clauses 8.1.1.1.2a and 8.1.1.1.2b.

The contention resolution has failed on the mobile station side when the mobile station does not receive a PACKET UPLINK ASSIGNMENT or MULTIPLE TBF UPLINK ASSIGNMENT message with its TLLI assigning at least one TBF for which resources were requested before expiry of timer T3168 (single uplink TBF requested) or T3188 (multiple uplink TBFs requested). The mobile station shall then reinitiate the packet access procedure unless the packet access procedure has already been attempted four times. In that case, TBF failure has occurred and an RLC/MAC error should be reported to the higher layer for each of the TBFs for which resources were requested.

### 7.1.3.4 Two phase packet access completion

The two phase packet access procedure is completed upon a successful contention resolution. The mobile station has entered the packet transfer mode or MAC-Shared state.

### 7.1.3.5 Timing Advance

If a Timing Advance Index is included in the PACKET UPLINK ASSIGNMENT message, the mobile station shall use the continuous timing advance procedure, using its allocation on PTCCH (see 3GPP TS 45.010). Otherwise, the continuous timing advance procedure shall not be used.

For the case where a TIMING\_ADVANCE\_VALUE field is not provided in the assignment message, the mobile station shall use its previous timing advance (either assigned in the previous IMMEDIATE ASSIGNMENT or IMMEDIATE PACKET ASSIGNMENT message received on AGCH or in the previous PACKET UPLINK ASSIGNMENT message received on PAGCH or got through the continuous timing advance procedure).

Otherwise, the mobile station is not allowed to send normal bursts on the uplink until it receives a valid timing advance either through the continuous timing advance procedure or in a PACKET POWER CONTROL/TIMING ADVANCE message.

In the case of a mobile station with a Dual Carrier configuration where the continuous timing advance procedure is used there is no explicit indication of the carrier on which the PTCCH is allocated, and the mobile station shall consider the PTCCH allocation to be on carrier 1 (see sub-clause 5.5.1.7). If a mobile station with a Dual Carrier configuration

subsequently receives an assignment message which results in the mobile station no longer being in a Dual Carrier configuration (but still in packet transfer mode), the mobile station shall consider the PTCCH allocation to be on the carrier on which packet resources are assigned.

### 7.1.3.6 RTTI Assignments

If assigned resources are for an RTTI configuration, then the assignment message (e.g. PACKET DOWNLINK ASSIGNMENT, PACKET UPLINK ASSIGNMENT, etc.) specifies a set of PDCH pairs for both the uplink and downlink.

If the default single carrier PDCH pair configuration is indicated, then the assignment is for resources on a subset of the PDCH pairs consisting of the ordered sequence of timeslots pairs 0 and 1 (pair 1), 2 and 3 (pair 2), 4 and 5 (pair 3), and 6 and 7 (pair 4) in both the uplink and on the downlink. If the default dual carrier PDCH pair configuration is indicated, then the assignment is for resources on a subset of the PDCH pairs consisting of the ordered sequence of timeslots pairs 0 and 1, 2 and 3, 4 and 5, and 6 and 7 on both carriers (respectively numbered as pairs 1 to 4 on the first carrier and pairs 5 to 8 on the second carrier) in both the uplink and on the downlink. Otherwise, the assignment is for resources on a subset of the PDCH pairs as specified in the DOWNLINK\_PDCH\_PAIRS\_C1, DOWNLINK\_PDCH\_PAIRS\_C2, UPLINK\_PDCH\_PAIRS\_C1 and UPLINK\_PDCH\_PAIRS\_C2 bitmaps.

If the mobile station is currently in packet transfer mode with one or more ongoing TBFs operating in RTTI configuration, then the network may indicate in the assignment message that the PDCH pair configuration is 'Unchanged'. In this case, the PDCH pair configuration described in the most recently received assignment message (for this mobile station) previous to this message applies.

The *Uplink Assignment PDCH Pairs Description* IE shall be included in a PACKET CS RELEASE INDICATION, PS HANDOVER COMMAND or DTM HANDOVER COMMAND message assigning an RTTI configuration for uplink TBF(s) if and only if no RTTI configuration description for downlink TBF(s) is provided in these messages.

For the purposes of interpreting the RTTI\_DOWNLINK\_PDCH\_PAIR\_ASSIGNMENT\_SC and RTTI\_DOWNLINK\_PDCH\_PAIR\_ASSIGNMENT\_DC bitmaps and the repeated USF structures in the Dynamic Allocation 2 struct and Uplink TBF Assignment 2 struct, PDCH pairs are ordered starting with the PDCH pair on carrier 1 using the lowest numbered timeslots, followed by the PDCH pair on carrier 1 using the next lowest numbered timeslots and so on, followed by the PDCH pair on carrier 2 using the lowest numbered timeslots (if present), etc.

For an uplink PDCH pair using timeslots  $i$  and  $j$ , where  $j > i$ , the corresponding downlink PDCH pair is:

- the one using timeslots  $i$  and  $j$ ; else, if no such PDCH pair is specified
- the one using timeslots  $i-1$  and  $i$ ; else, if no such PDCH pair is specified
- the one using timeslots  $i-2$  and  $i$ ; else, if no such PDCH pair is specified
- the one using timeslots  $i-3$  and  $i$  if such a PDCH pair exists.

NOTE: It may be the case that there is no downlink PDCH pair which corresponds to a given uplink PDCH pair.

For a downlink PDCH pair, the corresponding uplink PDCH pair is the uplink PDCH pair (if it exists) for which the downlink PDCH pair is the corresponding downlink PDCH pair.

NOTE: It may be the case that there is no uplink PDCH pair which corresponds to a given downlink PDCH pair.

The network shall activate FANR for any assigned TBF which uses an RTTI configuration (see sub-clause 9.1.14).

### 7.1.3.7 MTTI Configurations

If the mobile station supports MTTI configurations, the network may assign a mobile station a TBF comprising a combination of both RTTI and BTTI resources (i.e. MTTI resources). In this case the assigned MTTI resources consist of one PDCH and one or more PDCH-pairs where the PDCH is always assigned the timeslot adjacent to either the lowest or highest numbered timeslot of the assigned PDCH-pairs on that carrier. In a downlink dual carrier configuration, a TBF operating in MTTI configuration shall be assigned MTTI resources on one or both carriers. If MTTI resources are only assigned on one carrier then the remaining carrier may be assigned either BTTI or RTTI resources.

NOTE: Examples of valid and invalid MTTI configurations are illustrated in Annex M.

The specification of the following MAC procedures includes aspects which are specific to MTTI configurations:

- Selection of RLC data blocks for transmission on RTTI and BTTI resources (see sub-clause 8.1.1);
- Uplink transfer and PACCH operation when using Extended Dynamic Allocation (see sub-clauses 8.1.1.2.1 and 8.1.1.2.2).

Other MAC procedures applicable to the RTTI and BTTI resources assigned as part of an MTTI configuration apply as if they were separate TBFs, and therefore references to a "TBF operating in RTTI configuration" (respectively "TBF operating in BTTI configuration") shall also refer to "resources operating in RTTI configuration within an MTTI configuration" (respectively "resources operating in BTTI configuration within an MTTI configuration").

The specification of the following RLC procedures includes aspects which are specific to MTTI configurations:

- Encoding and interpretation of Piggy-backed Ack/Nack fields encoded using Time-based encoding (see sub-clauses 9.1.15 and 11.2.29);
- Countdown procedure: definition of MTS parameter (see sub-clause 9.3.1.1).

The network shall activate FANR for any assigned TBF which uses an MTTI configuration.

Reaction times applicable to TBFs operating in MTTI configurations shall be those specified for TBFs operating in RTTI configurations (see 3GPP TS 45.010)

## 7.1.4 Abnormal cases

If a failure occurs on the mobile station side of the new TBF before mobile station has successfully entered the packet transfer mode, the newly reserved resources are released; the subsequent behaviour of the mobile station depends on the type of failure and previous actions.

- If the failure is due to a TLLI mismatch, or to the expiry of timers T3166 or T3168, or to the fact that the counter N3104 reaches its maximum value in the contention resolution procedure, and repetition as described in sub-clauses 7.1.2.3, 7.1.3.2.1 or 7.1.3.3 has been performed, the mobile station shall remain in packet idle mode, notify higher layer (TBF establishment failure), transactions in progress shall be aborted and cell reselection continued, unless the failure takes place during a RR-cell change order procedure, in which case the mobile behaviour shall be as described in the Abnormal cases of the RR-Network Commanded Cell Change Order Procedure in 3GPP TS 44.018;
- If the mobile station has been assigned more PDCHs than it supports according to the relevant multislot configuration as defined in 3GPP TS 45.002, the mobile station shall reinitiate the packet access procedure unless the packet access procedure has already been attempted four times. In that case, TBF failure has occurred;
- If the information in the PACKET UPLINK ASSIGNMENT message does not properly specify an uplink PDCH or specifies a multislot configuration that the mobile station does not support (see 3GPP TS 45.002), the mobile station shall reinitiate the packet access procedure unless the packet access procedure has already been attempted four times. In that case, TBF failure has occurred;
- If the information in the MULTIPLE TBF UPLINK ASSIGNMENT message does not properly specify an uplink PDCH or specifies a multislot configuration that the mobile station does not support (see 3GPP TS 45.002), the mobile station shall reinitiate the packet access procedure for each of the TBFs for which there is an error unless the procedure has already been attempted 4 times for the TBF. In that case, TBF failure has occurred;
- If the MULTIPLE TBF UPLINK ASSIGNMENT message contains assignments including PFI values for which no TBF was requested, the mobile station shall not act upon these assignments. The mobile station shall act upon the valid assignments contained in the received message;
- If the MULTIPLE TBF UPLINK ASSIGNMENT message contains assignments such that more than one PFI value has been assigned to the same TFI, then TBF failure has occurred for the requests containing each of those PFI values;
- If the PACKET UPLINK ASSIGNMENT message contains an assignment including a PFI value for which no resources were requested, the mobile station shall not act upon the assignment. The mobile station shall reinitiate

the packet access procedure unless the packet access procedure has already been attempted four times. In that case, TBF failure has occurred;

- If the PACKET ACCESS REJECT message incorrectly specifies a *Reject structure* and *A/Gb mode Reject structure* for this mobile station, or contains one or more PFIs in the *A/Gb mode Reject structure* for which no TBF was requested, the mobile station shall ignore this message;
- If the mobile station has been assigned a TBF in EGPRS mode and the MS does not support EGPRS, or has been assigned an MCS (e.g. 8-PSK in the Uplink) that the MS does not support, the MS shall return to packet idle mode and notify higher layers (TBF establishment failure);
- On expiry of timer T3164, the mobile station shall reinitiate the packet access procedure for the corresponding TBF unless the packet access procedure has already been attempted four times for this TBF, in which case the mobile station shall notify higher layers of TBF establishment failure. If the mobile station has no remaining TBFs allocated it shall return to packet idle mode and notify higher layers (TBF establishment failure);
- If the failure is due to any other reason, the mobile station shall return to packet idle mode, notify higher layer (TBF establishment failure), transactions in progress shall be aborted and cell reselection continues.

## 7.2 TBF establishment initiated by the network on PCCCH

The purpose of network initiated TBF establishment is to establish a TBF to support the transfer of upper layer PDUs in the direction from the network to the mobile station. The procedure may be entered when the mobile station is in packet idle mode. Network initiated TBF establishment can also be done on PACCH if a TBF for transfer of upper layer PDUs in the direction from the mobile station to the network is already established (sub-clause 8.1.1.1.3).

If the mobile station is in dedicated mode and both the network and the mobile station support DTM, the establishment of a TBF shall be performed by the DTM assignment procedures on the main DCCH, as defined in 3GPP TS 44.018.

### 7.2.1 Entering the packet transfer mode

The procedure is triggered by a request from upper layers on the network side to transfer an upper layer PDU to a mobile station in packet idle mode. The request from upper layers specifies an optional priority level, a QoS profile including the requested RLC mode, optional DRX parameters, an optional IMSI and an optional MS Radio Access Capability, multislot class and mobile classmark to be associated with the packet transfer. The request is implicit when receiving an upper layer PDU to a mobile station not already having any assigned radio resources. Upon such a request, the network shall initiate a packet downlink assignment procedure as defined in sub-clause 7.2.1.1. The BSS may order its preferred RLC mode when establishing a downlink TBF, independently of the RLC mode signalled from upper layers. If the mobile station supports RLC non-persistent mode the network may allocate a downlink EGPRS TBF that uses this RLC mode.

#### 7.2.1.1 Packet downlink assignment procedure

The network may assign a radio resource on one or more PDCHs to be used for the TBF. The amount of radio resource to be reserved is a network dependent choice. If the network and mobile station both support Downlink Dual Carrier, the network may assign radio resources on one or more PDCHs on two different radio frequency channels to be used for the TBF.

The allocated radio resource is assigned to the mobile station in a PACKET DOWNLINK ASSIGNMENT message to the mobile station. The PACKET DOWNLINK ASSIGNMENT message is transmitted on the PCCCH timeslot corresponding to the PCCCH group the mobile station belongs to. The appropriate PCCCH group is calculated from the IMSI (see 3GPP TS 45.002). The behaviour of the network when the IMSI is not provided by the upper layers is implementation dependent for the calculation of the PCCCH group where the PACKET DOWNLINK ASSIGNMENT message has to be sent. If the mobile station is in non-DRX mode or if the IMSI or the DRX parameters are not provided by the upper layers, there is no further restriction on what part of the downlink PCCCH timeslot this PACKET DOWNLINK ASSIGNMENT message can be sent, provided that this part corresponds to one or more blocks where paging may appear. If the mobile station applies DRX, this message shall be sent in one or more PCCCH block(s) corresponding to a paging group determined for the mobile station in packet idle mode or MAC-Idle state (see 3GPP TS 45.002). The multislot capabilities of the mobile station shall be considered.



Initial timing advance can be provided in the PACKET DOWNLINK ASSIGNMENT message as Timing Advance Value field. In case valid timing advance for the mobile station is not available, the network may use one of the following two methods to trigger the mobile station to transmit a PACKET CONTROL ACKNOWLEDGEMENT message:

- if the PACKET DOWNLINK ASSIGNMENT message is not segmented and the CONTROL\_ACK\_TYPE parameter in the System Information indicates acknowledgement is access bursts, the network may set the poll bit in the PACKET DOWNLINK ASSIGNMENT message.
- if the PACKET DOWNLINK ASSIGNMENT message is segmented or the CONTROL\_ACK\_TYPE parameter in the System Information does not indicate acknowledgement is access bursts, the network may send PACKET POLLING REQUEST message with TYPE\_OF\_ACK parameter set to access bursts (see sub-clause 11.2.12).

The mobile station shall then send the PACKET CONTROL ACKNOWLEDGEMENT message as four access bursts in the reserved uplink radio block specified by the RRBP field as defined in sub-clause 10.4.5. The reserved block is considered as a one block PACCH allocation. The PACKET CONTROL ACKNOWLEDGEMENT message is used to derive the timing advance.

Thereafter, either the timing advance in the mobile station is updated with a PACKET POWER CONTROL /TIMING ADVANCE message or a continuous timing advance procedure is used. If a Timing Advance Index is included in the assignment message, the mobile station shall use the continuous timing advance procedure, using its allocation on PTCCH (see 3GPP TS 45.010). Otherwise the continuous timing advance procedure shall not be used. For the case where Timing Advance Value is not provided in the assignment message, the mobile station is not allowed to send normal bursts (e.g. PACKET DOWNLINK ACK/NACK message) on the uplink until it receives a valid timing advance either through the continuous timing advance procedure or in a PACKET POWER CONTROL /TIMING ADVANCE message.

In the case of a mobile station with a Downlink Dual Carrier configuration where the continuous timing advance procedure is used there is no explicit indication of the carrier on which the PTCCH is allocated, and the mobile station shall consider the PTCCH allocation to be on carrier 1 (see sub-clause 5.5.1.7). If a mobile station with a Downlink Dual Carrier configuration receives an assignment message which results in the mobile station no longer being in a Downlink Dual Carrier configuration (but still in packet transfer mode), the mobile station shall consider the PTCCH allocation to be on the carrier on which packet resources are assigned.

The mobile station shall use information received on the PBCCH to decode the channel descriptions contained in the assignment. If frequency hopping is applied, the mobile station shall use the last CA received on PBCCH to decode the Mobile Allocation. Alternatively, the network may provide a Mobile Allocation in the assignment. The radio resource is assigned to the mobile station in a PACKET DOWNLINK ASSIGNMENT message. On receipt of a PACKET DOWNLINK ASSIGNMENT message, the mobile station shall switch to the assigned PDCHs.

A PACKET DOWNLINK ASSIGNMENT message may indicate an assignment starting time in the TBF Starting Time parameter. The mobile station shall monitor PCCCH until the point in time denoted by the TBF Starting Time. If the mobile station receives more than one PACKET DOWNLINK ASSIGNMENT message while it monitors the PCCCH, it shall act upon the most recently received message and shall ignore the previous message.

When the PACKET DOWNLINK ASSIGNMENT message is received and after awaiting the point in time denoted by the TBF Starting Time, if such is indicated, the mobile station shall switch to the assigned PDCHs and start timer T3190. The timer T3190 is restarted when receiving the first valid RLC data block addressed to the mobile station. In EGPRS TBF mode T3190 is also restarted when receiving an erroneous RLC data block for which the header is correctly received and which addresses the mobile station.

When the mobile station switches to the assigned PDCHs, it shall take the power control parameters received in the PACKET DOWNLINK ASSIGNMENT message into account, perform signal strength measurements and apply output power control procedures as they are defined for packet transfer mode or MAC-Shared state (see 3GPP TS 45.008). In the case of a mobile station with a Downlink Dual Carrier configuration, the power control parameters may be different for each of the two carriers.

On expiry of timer T3190, the mobile station shall abort the procedure and return to packet idle mode or MAC-Idle state.

### 7.2.1.2 Packet downlink assignment procedure completion

The packet downlink assignment procedure is completed when the mobile station receives a valid RLC/MAC block. The mobile station has entered the packet transfer mode or MAC-Shared state.

### 7.2.1.3 Packet polling procedure

The network may send to the mobile station a PACKET POLLING REQUEST message. If the MS has received a PACKET DOWNLINK ASSIGNMENT message with no starting time or with a starting time that has already elapsed, the PACKET POLLING REQUEST message shall be sent on PACCH. Otherwise the PACKET POLLING REQUEST message shall be sent on PAGCH. The mobile station shall be addressed by its TLLI (*A/Gb mode*), G-RNTI (*Iu mode*) or TFI.

On receipt of a PACKET POLLING REQUEST message, the mobile station shall respond to the network with the PACKET CONTROL ACKNOWLEDGEMENT message in the reserved uplink radio block specified by the RRBP field as defined in sub-clause 10.4.5. The reserved block is considered as a one block PACCH allocation.

### 7.2.2 Abnormal cases

If a failure occurs on the mobile station side of the new TBF before mobile station has successfully entered the packet transfer mode or MAC-Shared state, the newly reserved resources are released; the subsequent behaviour of the mobile station depends on the type of failure and previous actions.

- If the mobile station has been assigned more PDCHs than it supports according to the relevant multislot configuration as defined in 3GPP TS 45.002, the mobile station shall return to packet idle mode or MAC-Idle state;
- If the mobile station has been assigned a TBF in EGPRS TBF mode and the MS does not support EGPRS, the MS shall return to packet idle mode or MAC-Idle state and notify higher layers (TBF establishment failure);
- On expiry of timer T3190, the mobile station shall return to packet idle mode or MAC-Idle state;
- If the failure is due to any other reason, the mobile station shall return to packet idle mode or MAC-Idle state and cell reselection continues.

## 7.3 Procedure for measurement report sending in packet idle mode

The procedure for measurement report sending shall be initiated by the mobile station at expiry of the NC measurement report interval timer T3158. At expiry of the timer T3158 the mobile station shall restart the expired timer T3158, perform the measurements and initiate the packet access.

The procedure for measurement report sending is initiated by the mobile station either on PCCCH (sub-clause 7.3.1) or, if a packet control channel not exists, on CCCH (sub-clause 7.3.2).

If the mobile station initiates the establishment of an RR connection, the timer T3158 shall be stopped and no measurement reports shall be sent. When the RR connection is released and if the mobile station has not changed cell, the measurement reporting procedure shall be restarted.

If a cell change has occurred during the RR connection, the measurements shall be cancelled until new NC orders have been received (see sub-clause 5.6).

### 7.3.1 Measurement report sending procedure initiated on PCCCH

The packet access procedure is initiated by the RR entity in the mobile station as specified in sub-clauses 7.1.2.1 and 7.1.2.2 but with access type "Single block without TBF establishment" indicated in the PACKET CHANNEL REQUEST message. In the following sub-clauses the procedure is only briefly summarised and special requirements are indicated.

#### 7.3.1.1 On receipt of a PACKET CHANNEL REQUEST message

On receipt of a PACKET CHANNEL REQUEST message with access type indicating 'Single block without TBF establishment', the network may allocate one radio block on an uplink PDCH.

If uplink resources are not available, the network may reject the access request by sending a PACKET ACCESS REJECT message (see sub-clause 7.3.1.3). The network shall not respond to a packet access for measurement reporting by sending a PACKET QUEUING NOTIFICATION message.

The radio resource is assigned to the mobile station in a PACKET UPLINK ASSIGNMENT message sent on any PAGCH on the same PCCCH on which the network has received the PACKET CHANNEL REQUEST message. The PACKET UPLINK ASSIGNMENT message shall include the following optional parameters:

- Power Control Parameters with timeslot allocation;
- Frequency parameters;
- TBF\_STARTING\_TIME indicating the frame number of the allocated block;
- TIMING\_ADVANCE\_VALUE;
- Packet Request Reference.

### 7.3.1.2 On receipt of a PACKET UPLINK ASSIGNMENT message

When receiving a PACKET UPLINK ASSIGNMENT message the mobile station shall send either the PACKET MEASUREMENT REPORT message or the PACKET ENHANCED MEASUREMENT REPORT message in the allocated radio block on the assigned PDCH and immediately switch back to the PCCCH in non-DRX mode (see sub-clause 5.5.1.5). No TBF is established and the network shall not acknowledge the reception of the PACKET MEASUREMENT REPORT message or the PACKET ENHANCED MEASUREMENT REPORT message.

The PACKET MEASUREMENT REPORT message shall contain the NC Measurement Report struct.

If timer T3170 expires before a PACKET UPLINK ASSIGNMENT message is received, the packet access procedure is aborted, the transmission of the measurement report for that measurement period is cancelled, and the mobile station shall indicate a random access failure to upper layer and perform autonomous cell re-selection.

### 7.3.1.3 On receipt of a PACKET ACCESS REJECT message

The network may send to the mobile station a PACKET ACCESS REJECT message.

The mobile station shall react to this as described in sub-clause 7.1.2.2.4 with the exception of the actions taken when either of the timers T3172 or T3162 expires. In this case, the measurement report initiating the packet access shall be discarded and the mobile station shall return to packet idle mode or MAC-Idle state.

If the measurement report interval timer T3158 expires before any of the timers T3172 or T3162 expires, no new measurement shall be initiated but the timer T3158 shall be restarted.

### 7.3.1.4 Abnormal cases

If the PACKET UPLINK ASSIGNMENT message contains faulty parameters, the mobile station shall abort the packet access procedure and return to packet idle mode or MAC-Idle state. The measurement report initiating the packet access shall be discarded.

If the mobile station receives either a PACKET QUEUING NOTIFICATION message or a PACKET POLLING REQUEST message, the mobile station shall abort the packet access procedure and return to packet idle mode or MAC-Idle state. The measurement report initiating the packet access shall be discarded.

## 7.3.2 Measurement report sending procedure initiated on CCCH

For detailed description of the procedures following in this sub-clause, see 3GPP TS 44.018. The procedure is here only briefly summarised and special requirements are indicated.

The packet access procedure is initiated by the RR entity in the mobile station. The mobile station sends a CHANNEL REQUEST message indicating "Single block packet access" on RACH. The network shall then respond with either an IMMEDIATE ASSIGNMENT message granting a "single block access" on a PDCH or an IMMEDIATE ASSIGNMENT REJECT message (see 3GPP TS 44.018).

If a PDCH block is assigned, the mobile station shall send either the PACKET MEASUREMENT REPORT message or the PACKET ENHANCED MEASUREMENT REPORT message in the allocated radio block on the assigned PDCH and then immediately switch back to the CCCH in non-DRX mode (see sub-clause 5.5.1.5). No TBF is established and the network shall not acknowledge the reception of the PACKET MEASUREMENT REPORT message or the PACKET ENHANCED MEASUREMENT REPORT message.

The PACKET MEASUREMENT REPORT message shall contain the NC Measurement Report struct.

On receipt of an IMMEDIATE ASSIGNMENT REJECT message the mobile station shall follow the procedure specified in 3GPP TS 44.018 sub-clause "Packet access rejection" with the exception of the actions taken when either of the 3GPP TS 44.018 timers T3142 or T3146 expires. In this case, the measurement report initiating the packet access shall be discarded and the mobile station shall return to packet idle mode.

If the measurement report interval timer T3158 expires before any of the 3GPP TS 44.018 timers T3142 or T3146 expires, no new measurement shall be initiated but the timer T3158 shall be restarted.

## 7.4 Cell Change Order procedures in Packet Idle mode

For an individual mobile station in packet idle mode, the network may initiate the cell change order procedure either on PCCCH or, if a packet control channel does not exist, on CCCH.

### 7.4.1 Cell Change Order procedure initiated on PCCCH

The network may initiate the cell change order procedure by sending a PACKET CELL CHANGE ORDER message in a PCCCH block monitored by the mobile station. No TBF shall be established.

The PACKET CELL CHANGE ORDER message contains:

- The characteristics of the new cell that are necessary to identify it (i.e. BSIC + BCCH frequency);
- The NC measurement parameters valid for the mobile station in the new cell (NETWORK\_CONTROL\_ORDER and optionally: NC\_NON\_DRX\_PERIOD, NC\_REPORTING\_PERIOD\_I and NC\_REPORTING\_PERIOD\_T).

For a multi-RAT mobile station supporting UTRAN, the PACKET CELL CHANGE ORDER message may contain information on a UTRAN target cell; in this case, the establishment of channel(s) and subsequent measurement reporting are defined in 3GPP TS 25.331.

For a multi-RAT mobile station supporting "CCN towards E-UTRAN, E-UTRAN Neighbour Cell measurement reporting and Network controlled cell reselection to E-UTRAN", the PACKET CELL CHANGE ORDER message may contain information on an E-UTRAN target cell; in this case, the establishment of channel(s) and subsequent measurement reporting are defined in 3GPP TS 36.331.

If the mobile station is not involved in an RR connection, upon receipt of the PACKET CELL CHANGE ORDER message, the mobile station shall stop all relevant RLC/MAC timers except for timers related to measurement reporting and start timer T3174. The mobile station shall then switch to the specified new cell and obey the relevant RLC/MAC procedures on this new cell. If a valid RRBP field was received in the PACKET CELL CHANGE ORDER message then the MS shall send a PACKET CONTROL ACKNOWLEDGMENT message in the reserved uplink radio block specified by the RRBP field before switching to the new cell. If the timers related to measurement reporting expire while the reselection procedure has not yet been completed, these timers shall be restarted so that the mobile station resumes the measurement reporting procedures once camped on the new cell. A UTRAN capable mobile station ordered to a UTRAN cell shall obey the PACKET CELL CHANGE ORDER message irrespective of whether the target cell is known or not known (see 3GPP TS 25.133 and 3GPP TS 25.123); an E-UTRAN capable mobile station ordered to an E-UTRAN cell shall obey the PACKET CELL CHANGE ORDER message irrespective of whether the target cell is known or not known (see 3GPP TS 36.133).

If the mobile station is involved in an RR connection, the mobile station shall ignore the PACKET CELL CHANGE ORDER message.

The procedure for completion of the cell change order is defined in sub-clause 8.4.1 and abnormal procedures are defined in sub-clause 8.4.2.

## 7.4.2 Cell Change Order procedure initiated on CCCH

The network may initiate the cell change order procedure by sending an IMMEDIATE ASSIGNMENT message for single block assignment in a CCCH block monitored by the mobile station. No TBF shall be established. The single block assignment procedure is specified in 3GPP TS 44.018.

The network shall then send the PACKET CELL CHANGE ORDER message in the assigned downlink block to the mobile station. The PACKET CELL CHANGE ORDER message contains:

- the characteristics of the new cell that are necessary to identify it (i.e. BSIC + BCCH frequency);
- the NC measurement parameters valid for the mobile station in the new cell (NETWORK\_CONTROL\_ORDER and optionally: NC\_NON\_DRX\_PERIOD, NC\_REPORTING\_PERIOD\_I and NC\_REPORTING\_PERIOD\_T).

For a multi-RAT mobile station supporting UTRAN, the PACKET CELL CHANGE ORDER message may contain information on a UTRAN target cell; in this case, the establishment of channel(s) and subsequent measurement reporting are defined in 3GPP TS 25.331.

For a multi-RAT mobile station supporting "CCN towards E-UTRAN, E-UTRAN Neighbour Cell measurement reporting and Network controlled cell reselection to E-UTRAN", the PACKET CELL CHANGE ORDER message may contain information on an E-UTRAN target cell; in this case, the establishment of channel(s) and subsequent measurement reporting are defined in 3GPP TS 36.331.

Upon receipt of the PACKET CELL CHANGE ORDER message, the mobile station shall stop all relevant RLC/MAC timers except for timers related to measurement reporting and start timer T3174. The mobile station shall then switch to the specified new cell and obey the relevant RLC/MAC procedures on this new cell. If a valid RRBP field was received in the PACKET CELL CHANGE ORDER message then the MS shall send a PACKET CONTROL ACKNOWLEDGMENT message in the reserved uplink radio block specified by the RRBP field before switching to the new cell. If the timers related to measurement reporting expire while the reselection procedure has not yet been completed, these timers shall be restarted so that the mobile station resumes the measurement reporting procedures once camped on the new cell. A UTRAN capable mobile station ordered to a UTRAN cell shall obey the PACKET CELL CHANGE ORDER message irrespective of whether or not the target cell is known (see 3GPP TS 25.133 and 3GPP TS 25.123); an E-UTRAN capable mobile station ordered to an E-UTRAN cell shall obey the PACKET CELL CHANGE ORDER message irrespective of whether the target cell is known or not known (see 3GPP TS 36.133).

The procedure for completion of the cell change order is defined in sub-clause 8.4.1 and abnormal procedures are defined in sub-clause 8.4.2.

## 7.5 Measurement Order procedures in Packet Idle mode

To send the NC Measurement order to an individual mobile station in packet idle mode, the network may establish a connection either on PCCCH or, if a packet control channel does not exist, on CCCH.

### 7.5.1 Measurement Order procedures initiated on PCCCH

The network may initiate the measurement order procedure by sending a PACKET MEASUREMENT ORDER message in a PCCCH block monitored by the mobile station. The PACKET MEASUREMENT ORDER message overrides a broadcast PSI5 message. If the PACKET MEASUREMENT ORDER message contains multiple instances, the network shall send all instances to the mobile station.

The PACKET MEASUREMENT ORDER message may contain the following optional Measurement order parameters:- TLLI (shall be included in *A/Gb mode*);

- G-RNTI (shall be included in *Iu mode*);
- Enhanced measurement parameters.

Upon receipt of the PACKET MEASUREMENT ORDER message, the mobile station shall store the Measurement order parameters. The mobile station shall obey the NETWORK\_CONTROL\_ORDER as specified in 3GPP TS 45.008 and in sub-clause 5.6.

## 7.5.2 Measurement Order procedures initiated on CCCH

The network may initiate the measurement order procedure by allocating a single block in an IMMEDIATE ASSIGNMENT message sent to the mobile station on a CCCH block in the same way as specified in sub-clause 7.4.2.

The network shall then send the PACKET MEASUREMENT ORDER message in the assigned downlink block to the mobile station. The PACKET MEASUREMENT ORDER message overrides a broadcast PSI5 message. If the PACKET MEASUREMENT ORDER message contains multiple instances, the network has to repeat the complete procedure with new assignment for each instance of the message.

The PACKET MEASUREMENT ORDER message may contain the following optional Measurement order parameters:

- TLLI (shall be included);
- NC Measurement Parameters (NETWORK\_CONTROL\_ORDER; NC\_NON\_DRX\_PERIOD; NC\_REPORTING\_PERIOD\_I; NC\_REPORTING\_PERIOD\_T; NC\_FREQUENCY\_LIST);
- Enhanced measurement parameters.

Upon receipt of the PACKET MEASUREMENT ORDER message, the mobile station shall store the Measurement order parameters. The mobile station shall obey the NETWORK\_CONTROL\_ORDER as specified in 3GPP TS 45.008 and in sub-clause 5.6.

## 7.6 Packet Pause procedure

This procedure enables the network to pause GPRS services packet flow for a mobile station with non-GSM capabilities in the downlink direction. The procedure is initiated by the mobile station either on a PCCCH (sub-clause 7.6.1) or, if a packet control channel does not exist, on a CCCH (sub-clause 7.6.2).

### 7.6.1 Packet pause procedure initiated on PCCCH

The packet access procedure is initiated by the RR entity in the mobile station as specified in sub-clauses 7.1.2.1 and 7.1.2.2 but with access type "Single block without TBF establishment" indicated in the PACKET CHANNEL REQUEST message.

#### 7.6.1.1 On receipt of a PACKET CHANNEL REQUEST message

On receipt of a PACKET CHANNEL REQUEST message with access type indicating "Single block without TBF establishment", the network may allocate one radio block on an uplink PDCH.

If uplink resources are not available, the network may reject the access request by sending a PACKET ACCESS REJECT message (see sub-clause 7.6.1.3). The network shall not respond by sending a PACKET QUEUING NOTIFICATION message.

The radio resource is assigned to the mobile station in a PACKET UPLINK ASSIGNMENT message sent on any PAGCH on the same PCCCH on which the network has received the PACKET CHANNEL REQUEST message. The PACKET UPLINK ASSIGNMENT message shall include the following optional parameters:

- Power Control Parameters with timeslot allocation;
- Frequency parameters;
- TBF\_STARTING\_TIME indicating the frame number of the allocated block;
- TIMING\_ADVANCE\_VALUE;
- Packet Request Reference.

### 7.6.1.2 On receipt of a PACKET UPLINK ASSIGNMENT message

When receiving a PACKET UPLINK ASSIGNMENT message the mobile station shall send PACKET PAUSE in the allocated radio block on the assigned PDCH. The mobile station shall stop timer T3204. No TBF is established and the network shall not acknowledge the reception of the PACKET PAUSE message.

If timer T3204 expires before a PACKET UPLINK ASSIGNMENT message is received, the packet pause procedure is aborted.

### 7.6.1.3 On receipt of a PACKET ACCESS REJECT message

The network may send to the mobile station a PACKET ACCESS REJECT message. The mobile station shall react by aborting the packet pause procedure and stopping timer T3204.

### 7.6.1.4 Abnormal cases

If on the mobile station side timer T3204 expires indicating unsuccessful channel request procedure or if the PACKET UPLINK ASSIGNMENT message contains faulty parameters, the mobile station shall abort the packet pause procedure.

If the mobile station receives either a PACKET QUEUING NOTIFICATION message or a PACKET POLLING REQUEST message, the mobile station shall abort the packet pause procedure.

## 7.6.2 Packet pause procedure initiated on CCCH

For a description of the procedure, see 3GPP TS 44.018.

## 7.7 MBMS packet access and establishment procedures

### 7.7.1 MBMS packet access procedure

#### 7.7.1.1 General

This procedure enables the network to count the number of mobile stations in a cell that want to receive an MBMS session. If the procedure is initiated by the mobile station as a response to an MBMS notification, which contains uplink resource description for an MPRACH, or after cell reselection during an ongoing MBMS session, if the mobile station is in DRX mode (e.g. it is not involved in a *routing area update* procedure) and has received in the old serving cell the indication that in the new cell an MPRACH is allocated for that MBMS session, the procedure shall be initiated on that MPRACH (sub-clause 7.7.1.4). Otherwise the procedure is initiated by the mobile station either on a PCCCH (sub-clause 7.7.1.2) or, if a packet control channel is not allocated in the cell, on a CCCH (sub-clause 7.7.1.3).

The procedure may be initiated by the mobile station either:

- as a response to an MBMS notification where counting is requested; or
- in the new cell after cell reselection during an ongoing MBMS session, if MBMS is supported by the network in the new cell; or
- when a request is received from upper layer in the mobile station, if MBMS is supported by the network in the cell; or
- after timeout when waiting for an RLC block for this session.

**NOTE:** The mobile station shall not initiate an MBMS packet access procedure in a new cell after cell reselection if the mobile station already has information about the location and identifier of the MBMS radio bearer relevant to the ongoing MBMS session in that new cell and it contains no uplink feedback channel.

A mobile station that is IMSI attached (GPRS class A or B mode of operation) shall respond to a PACKET PAGING REQUEST message indicating an RR connection establishment or TBF establishment. For that purpose, the mobile station shall abort the MBMS packet access procedure, according to the conditions stated in sub-clause 6.1.4.

If the mobile station receives a PACKET DOWNLINK ASSIGNMENT message, it shall abort the MBMS packet access procedure and respond to the PACKET DOWNLINK ASSIGNMENT message (see sub-clause 7.2.1)

## 7.7.1.2 MBMS packet access procedure on PCCCH

### 7.7.1.2.0 Initiation of the MBMS packet access procedure

The packet access procedure for an MBMS session is initiated by the mobile station on PCCCH, as specified in sub-clauses 7.1.2.1 with access type "Single block MBMS access" indicated in the PACKET CHANNEL REQUEST message.

#### 7.7.1.2.1 On receipt of a PACKET CHANNEL REQUEST message

On receipt of a PACKET CHANNEL REQUEST message with access type indicating "Single block MBMS access", the network may either allocate one radio block on an uplink PDCH, as specified in sub-clause 7.1.2.1 or, if uplink resources are not available, reject the access request by sending a PACKET ACCESS REJECT message (see sub-clause 7.7.1.2.3).

The radio resource is assigned to the mobile station in a PACKET UPLINK ASSIGNMENT message sent on any PAGCH on the same PCCCH on which the network has received the PACKET CHANNEL REQUEST message. The PACKET UPLINK ASSIGNMENT message shall include the following optional parameters:

- Power Control Parameters with timeslot allocation;
- Frequency parameters;
- TBF\_STARTING\_TIME indicating the frame number of the allocated block;
- TIMING\_ADVANCE\_VALUE;
- Packet Request Reference.

#### 7.7.1.2.2 On receipt of a PACKET UPLINK ASSIGNMENT message

When receiving a PACKET UPLINK ASSIGNMENT message, corresponding to one of its 3 last PACKET CHANNEL REQUEST messages, the mobile station shall send the MBMS SERVICE REQUEST message in the allocated radio block on the assigned PDCH and then start timer T3214. While timer T3214 is running the mobile station shall accept reception of repeated PACKET UPLINK ASSIGNMENT messages, on any PAGCH on the same PCCCH on which the mobile station has sent the PACKET CHANNEL REQUEST message, and re-send the MBMS SERVICE REQUEST in the allocated block on the assigned PDCH and restart the timer T3214.

At expiry of timer T3214, a mobile station in packet idle mode or MAC-Idle state shall return to DRX mode. No radio bearer will be established in the cell for the concerned MBMS session. A mobile station in broadcast/multicast receive mode shall remain in broadcast/multicast receive mode.

#### 7.7.1.2.3 On receipt of a PACKET ACCESS REJECT message

The network may send a PACKET ACCESS REJECT message to the mobile station in response to a PACKET CHANNEL REQUEST message. The mobile station shall then react as described in sub-clause 7.1.2.2.4.

#### 7.7.1.2.4 On receipt of an MBMS ASSIGNMENT message

When the mobile station receives an MBMS ASSIGNMENT message for an MBMS session, it shall stop any ongoing packet access procedure for that MBMS session and proceed according to sub-clause 7.7.2.2.

#### 7.7.1.2.5 Abnormal cases

If the mobile station receives a PACKET UPLINK ASSIGNMENT message that contains faulty parameters, the mobile station shall abort the MBMS packet access procedure.



### 7.7.1.3 MBMS packet access procedure on CCCH

For a description of the procedure, see 3GPP TS 44.018.

### 7.7.1.4 MBMS packet access procedure on MPRACH

#### 7.7.1.4.1 Initiation of the MBMS packet access procedure on MPRACH

The mobile station initiates the MBMS packet access procedure on MPRACH by sending an MPRACH PACKET CHANNEL REQUEST message (see sub-clause 11.2.5c) with access type "Single block MBMS access" on the MPRACH.

The mobile station shall determine the control parameters from the MPRACH control parameters included in the MBMS notification or in the MBMS NEIGHBOURING CELL INFORMATION message transmitted in the old serving cell, if present. If an MPRACH control parameter is not available, the last received corresponding control parameter for the PRACH, if PCCCH is present, shall be used; otherwise the last received corresponding control parameter for the RACH shall be used.

At sending of the first MPRACH PACKET CHANNEL REQUEST message, the mobile station shall store the value for the Retry (R) bit to be transmitted in all the subsequent MAC headers as 'MS sent channel request message once'. If a second MPRACH PACKET CHANNEL REQUEST message is sent, the mobile station shall change the value for the Retry (R) bit to 'MS sent channel request message twice or more'.

While waiting for a response to the MPRACH PACKET CHANNEL REQUEST message the mobile station shall continue to monitor the CCCH/PCCCH (whichever is applicable) corresponding to its CCCH\_GROUP/PCCCH\_GROUP. The mobile station shall perform signal strength measurements as they are defined for packet idle mode, see 3GPP TS 45.008.

A mobile station that is IMSI attached (GPRS class A or B mode of operation) shall respond to a PACKET PAGING REQUEST message indicating an RR connection establishment. For that purpose, the mobile station may abort the packet access procedure, according to the conditions stated in sub-clause 6.1.4. The mobile station shall not respond to a PACKET PAGING REQUEST message indicating TBF establishment.

A mobile station that is not IMSI attached (GPRS class C mode of operation) shall not respond to any type of PACKET PAGING REQUEST messages during the packet access procedure, it shall only decode the PERSISTENCE\_LEVEL parameter, if that is included in the message.

#### 7.7.1.4.1.1 Access persistence control on MPRACH

The mobile station shall make maximally  $M + 1$  attempts to send an MPRACH PACKET CHANNEL REQUEST message.

The mobile station shall use the control parameters determined by the procedure described in sub-clause 7.7.1.4.1:

- MAX\_RETRANS;
- PERSISTENCE\_LEVEL, which consists of the PERSISTENCE\_LEVEL  $P \in \{0, 1, \dots, 14, 16\}$ . If the control parameters do not contain the PERSISTENCE\_LEVEL parameter, this shall be interpreted as if  $P = 0$ ;
- S;
- TX\_INT.

The mobile station shall start timer T3186 at the beginning of the MPRACH packet access procedure. At expiry of timer T3186, the MPRACH packet access procedure shall be aborted, and:

- if at least one MPRACH PACKET CHANNEL REQUEST message was transmitted by the mobile station, a random access failure shall be indicated to upper layers and the mobile station shall perform autonomous cell re-selection according to 3GPP TS 43.022;
- otherwise, a packet access failure shall be indicated to upper layers and the mobile station shall return to packet idle mode or MAC-Idle state.

The first attempt to send an MPRACH PACKET CHANNEL REQUEST message may be initiated at the first available MPRACH block on the indicated PDCH. The mobile station shall choose one of the four TDMA frames within the selected MPRACH block randomly with a uniform probability distribution.

For each attempt, the mobile station shall draw a random value  $R$  with uniform probability distribution in the set  $\{0, 1, \dots, 15\}$ . The mobile station is allowed to transmit an MPRACH PACKET CHANNEL REQUEST message if  $P$  is less than or equal to  $R$ .

After each attempt, the  $S$  and  $T$  parameters are used to determine the next TDMA frame in which it may be allowed to make a successive attempt. The number of TDMA frames, belonging to the MPRACH on the indicated PDCH, between two successive attempts to send an MPRACH PACKET CHANNEL REQUEST message, excluding the TDMA frames potentially containing the messages themselves, is a random value drawn for each transmission, with uniform probability distribution, in the set  $\{S, S + 1, \dots, S + T - 1\}$ ;

Here:

$M$  is the value of the parameter MAX\_RETRANS;

$T$  is the value of the parameter TX\_INT;

$S$  is the value of the parameter  $S$ .

Having made  $M + 1$  attempts to send an MPRACH PACKET CHANNEL REQUEST message, the mobile station shall stop timer T3186 and start timer T3170 if at least one MPRACH PACKET CHANNEL REQUEST message was transmitted by the mobile station. In this case, at expiry of timer T3170, the packet access procedure shall be aborted, a random access failure shall be indicated to upper layers and the mobile station shall perform autonomous cell re-selection according to 3GPP TS 43.022. Otherwise, the packet access procedure shall be aborted, a packet access failure shall be indicated to upper layers and the mobile station shall return to packet idle mode or MAC-Idle state.

If the mobile station receives a PACKET DOWNLINK ASSIGNMENT message while it is waiting for a response to an MPRACH PACKET CHANNEL REQUEST message, it shall abort the MBMS packet access procedure on MPRACH and respond to the PACKET DOWNLINK ASSIGNMENT message (see sub-clause 7.2.1).

#### 7.7.1.4.2 On receipt of an MPRACH PACKET CHANNEL REQUEST

On receipt of an MPRACH PACKET CHANNEL REQUEST message with access type indicating "Single block MBMS access", the network shall either allocate one radio block on an uplink PDCH by sending a PACKET UPLINK ASSIGNMENT message on the downlink PDCH corresponding to the uplink PDCH where the MPRACH is allocated or, if uplink resources are not available, reject the access request by sending a PACKET ACCESS REJECT message on the same downlink PDCH (see sub-clause 7.7.1.4.3).

The PACKET UPLINK ASSIGNMENT message shall include the optional parameters:

- Power Control Parameters with timeslot allocation;
- Frequency parameters;
- TBF\_STARTING\_TIME indicating the frame number of the allocated block;
- TIMING\_ADVANCE\_VALUE;
- Packet Request Reference.

#### 7.7.1.4.3 On receipt of a PACKET ACCESS REJECT message

The network may, as response to an MPRACH PACKET CHANNEL REQUEST message, send to the mobile station a PACKET ACCESS REJECT message on the downlink PDCH corresponding to the uplink PDCH where the MPRACH is allocated. This message contains the request reference with time of reception of the MPRACH PACKET CHANNEL REQUEST message and optionally a WAIT\_INDICATION field in the Reject structure of the PACKET ACCESS REJECT message.

On receipt of a PACKET ACCESS REJECT message containing a Reject structure addressed to the mobile station, where the Packet Request Reference in the Reject structure corresponds to one of its 3 last MPRACH PACKET CHANNEL REQUEST messages:

- The mobile station shall stop timer T3186, stop sending MPRACH PACKET CHANNEL REQUEST messages, start timer T3172 with the value indicated in the WAIT\_INDICATION field, start timer T3170 if it has not already been started and listen to the downlink PCCCH until timer T3170 expires. During this time, the mobile station shall ignore additional PACKET ACCESS REJECT messages. During this time, on reception of any PACKET UPLINK ASSIGNMENT message corresponding to any other of its 3 last MPRACH PACKET CHANNEL REQUEST messages, the mobile station shall stop timers T3170 and T3172 if running, and follow the procedure defined in sub-clause 7.1.2.2.1b;
- If no PACKET UPLINK ASSIGNMENT message is received before expiration of timer T3170, the mobile station shall indicate a packet access failure to upper layer and return to packet idle mode (listening to its paging channel). As an option the mobile station may stop timer T3170, indicate a packet access failure to upper layer and return to packet idle mode as soon as it has received responses from the network on all or, in case more than 3 were sent, the last 3 of its MPRACH PACKET CHANNEL REQUEST messages. If the mobile station is already engaged in a parallel broadcast/multicast session the mobile station shall remain in broadcast/multicast receive mode;
- If an erroneous PACKET UPLINK ASSIGNMENT message (e.g. the mobile station has been assigned more PDCHs than it supports according to the relevant multislot configuration as defined in 3GPP TS 45.002) addressed to the mobile station is received before expiration of timer T3170, the mobile station shall stop T3170 and act as stated in sub-clause 7.1.4;
- If the mobile station receives a PACKET DOWNLINK ASSIGNMENT message, it shall stop timer T3170 if running and respond to the PACKET DOWNLINK ASSIGNMENT message (see sub-clause 7.2.1);
- The mobile station is not allowed to make a new attempt for packet access in the same cell until timer T3172 expires, but may attempt packet access in another cell after successful cell reselection for radio conditions reasons (see 3GPP TS 45.008). In *A/Gb mode*, a mobile station that is IMSI attached (GPRS class A or B mode of operation) may attempt to enter the dedicated mode in the same cell before timer T3172 has expired. During the time T3172 is running, the mobile station shall ignore all received PACKET PAGING REQUEST messages except paging requests sent to trigger RR connection establishment and paging requests sent to trigger the acquisition of an ETWS Primary Notification message;
- The value of the WAIT\_INDICATION field (i.e. timer T3172) relates to the cell from which it was received.

#### 7.7.1.4.4 On receipt of a PACKET UPLINK ASSIGNMENT message

On receipt of a PACKET UPLINK ASSIGNMENT message corresponding to one of its 3 last MPRACH PACKET CHANNEL REQUEST messages the mobile station shall stop timers T3186 and T3170 if running and stop sending MPRACH PACKET CHANNEL REQUEST messages. The mobile station shall send the MBMS SERVICE REQUEST message in the allocated radio block on the assigned PDCH and then start timer T3214. While timer T3214 is running the mobile station shall accept reception of repeated PACKET UPLINK ASSIGNMENT messages, on the downlink PDCH corresponding to the uplink PDCH where the MPRACH is allocated, and re-send the MBMS SERVICE REQUEST in the allocated block on the assigned PDCH and restart the timer T3214.

At expiry of timer T3214, a mobile station in packet idle mode or MAC-Idle state shall return to DRX mode and shall consider the MBMS radio bearer as not established in the cell for the concerned MBMS session. A mobile station in broadcast/multicast receive mode shall remain in broadcast/multicast receive mode.

#### 7.7.1.4.5 On receipt of an MBMS ASSIGNMENT message

When the mobile station receives an MBMS ASSIGNMENT message for an MBMS session, it shall stop any ongoing packet access procedure for that MBMS session and proceed according to sub-clause 7.7.2.2.

### 7.7.2 Establishment of MBMS bearer

#### 7.7.2.1 General

The network may send an MBMS ASSIGNMENT message to the mobile station(s) in order to inform about the establishment of a radio bearer for an MBMS session in the cell or to notify the mobile station(s) that a radio bearer for that MBMS session is not established in the cell. The decision of whether to establish a radio bearer for an MBMS session in a cell is a network dependent choice.

If the network sends the MBMS ASSIGNMENT message subsequent to an MBMS Notification for the same MBMS session, the MBMS ASSIGNMENT message shall be sent on any PAGCH on the same PCCCH on which the network has sent the MBMS Notification or, if a packet control channel does not exist, the IMMEDIATE ASSIGNMENT message including the *Multiple Blocks Packet Downlink Assignment* construction shall be sent on any AGCH on the same CCCH on which the network has sent the MBMS Notification, followed by the MBMS ASSIGNMENT message sent on the PDCH specified by the *Packet Channel Description* IE in the IMMEDIATE ASSIGNMENT message (see 3GPP TS 44.018).

In case the network sends the MBMS ASSIGNMENT message in response to an MBMS SERVICE REQUEST message which is not sent as a response to an MBMS Notification, the MBMS ASSIGNMENT message shall be sent either:

- on the PCCCH corresponding to the mobile station PCCCH\_GROUP, if the mobile station initiated the MBMS packet access procedure on the MPRACH, or
- on any PAGCH on the same PCCCH on which the mobile station sent the PACKET CHANNEL REQUEST message with access type "Single block MBMS access" or,
- if a packet control channel does not exist, the IMMEDIATE ASSIGNMENT message including the *Multiple Blocks Packet Downlink Assignment* construction shall be sent on the CCCH corresponding to the mobile station CCCH\_GROUP, if the mobile station initiated the MBMS packet access procedure on the MPRACH, or on any AGCH on the same CCCH on which the mobile station sent the CHANNEL REQUEST message with access type "Single block MBMS access", followed by the MBMS ASSIGNMENT message sent on the PDCH specified by the *Packet Channel Description* IE in the IMMEDIATE ASSIGNMENT message (see 3GPP TS 44.018).

### 7.7.2.2 On receipt of an MBMS ASSIGNMENT message

On reception of the MBMS ASSIGNMENT message the mobile station shall stop timer T3214 if running and enters broadcast/multicast receive mode.

If the MBMS ASSIGNMENT message indicates that a radio bearer is established for the MBMS session in the cell, and thus contains an MBMS bearer description, the mobile station shall set and start the session duration timer for this MBMS session with a value equal to the Estimated Session Duration and shall listen to downlink RLC blocks identified by the assigned MBMS Bearer Identity value on the defined PDCHs. The network may assign a radio resource on one or more PDCHs to be used for the radio bearer. The amount of radio resource to be reserved is a network dependent choice and shall not exceed the multislot capability of an MBMS capable mobile station (see 3GPP TS 45.002). The MBMS In-band Signalling Indicator information element included in the MBMS ASSIGNMENT message indicates whether or not the network shall send system information messages and (for mobile stations with an assigned MS\_ID on that MBMS radio bearer) paging messages on the PACCH of the MBMS radio bearer.

The MBMS bearer description may indicate an MBMS radio bearer starting time. If the mobile station receives the MBMS ASSIGNMENT message before the MBMS radio bearer starting time has expired, it shall wait until the point in time denoted by the MBMS radio bearer starting time, leave non-DRX mode, switch to the assigned PDCHs and start timer T3190. If the mobile station receives the MBMS ASSIGNMENT message after the MBMS radio bearer starting time has expired, it shall ignore the indicated MBMS radio bearer starting time, leave non-DRX mode, immediately switch to the assigned PDCHs and start timer T3190. If the mobile station receives an MBMS ASSIGNMENT message including an MBMS bearer description without an MBMS radio bearer starting time, it shall leave non-DRX mode, immediately switch to the assigned PDCHs and start timer T3190. The timer T3190 is restarted when receiving the first valid RLC data block including the assigned MBMS Bearer Identity. On expiry of timer T3190, the mobile station shall abort the procedure and repeat the MBMS packet access procedure for the MBMS session.

If the mobile station receives more than one MBMS ASSIGNMENT message while it monitors the PCCCH or, if a packet control channel does not exist, the CCCH (see 3GPP TS 44.018), it shall act upon the most recently received message and shall ignore the previous message.

If the MBMS ASSIGNMENT message indicates that no radio bearer is established for the MBMS session in the cell, the mobile station shall act according to the indication in the Reject cause.

- If the cause value indicates that further MBMS packet accesses are allowed for this MBMS session in the same cell, as long as the session duration timer for this MBMS session in the mobile station is still running, the mobile station may perform more access attempts for the current MBMS session in this cell or in any other cell where MBMS is supported by the network;

- If the cause value indicates that no further MBMS packet accesses are allowed for this MBMS session in the same cell, the mobile station shall not perform any further access attempts for the current MBMS session in this cell. As long as the session duration timer for this MBMS session in the mobile station is still running, the mobile station may perform access attempts for the MBMS session in any other cell to which the mobile station has performed cell reselection, if MBMS is supported by the network in that cell;
- If the cause value indicates that no further MBMS packet accesses are allowed for this MBMS session in the same Routing Area, the mobile station shall not perform any further access attempts for the current MBMS session in this Routing Area. As long as the session duration timer for this MBMS session in the mobile station is still running, the mobile station may perform access attempts for the MBMS session in any other cell, in any other Routing Area, to which the mobile station has performed cell reselection, if MBMS is supported by the network in that cell;
- If the cause value indicates that no further MBMS packet accesses are allowed for this MBMS session in this PLMN, the mobile station shall not perform any further access attempts for the MBMS session.

When the session duration timer for the MBMS session in the mobile station expires, the mobile station shall no longer perform access attempts for that MBMS session in any cell and shall indicate to the upper layers the end of the MBMS session.

Independent on the Reject cause value received and on the expiry of the session duration timer for the MBMS session, the mobile station may always perform new MBMS packet accesses for the MBMS session if a new MBMS Notification addressing that MBMS session, and indicating that counting shall be performed, is received.

In case the network sends the MBMS ASSIGNMENT message in response to an MBMS SERVICE REQUEST message which is not sent as a response to an MBMS Notification, and the MBMS ASSIGNMENT message contains the MBMS bearer description and an uplink feedback channel is used, then the network may include the TLLI of the mobile station, the MS\_ID and the timing advance parameters in the MBMS ASSIGNMENT message. If no MS\_ID identifier is available on the network side, the network notifies the mobile station of the lack of an MS\_ID identifier, preventing the mobile station from repeating the MBMS packet access procedure in this cell.

### 7.7.2.3 Abnormal cases

If on the mobile station side timer T3214 expires indicating that no MBMS bearer will be established for the specific MBMS session in the cell or if the MBMS ASSIGNMENT message contains faulty parameters, the mobile station shall abort the MBMS packet access procedure.

### 7.7.2.4 MBMS address assignment procedure

In case an uplink feedback channel is associated to an established MBMS radio bearer, then the network may assign an MS\_ID to a given mobile station receiving this MBMS radio bearer by sending an MBMS MS\_ID ASSIGNMENT message including the MS\_ID and the timing advance parameters assigned to the mobile station. The mobile station shall be addressed by its TLLI. This message shall not be sent before the point in time denoted by the MBMS radio bearer starting time, if present in the previous MBMS ASSIGNMENT message.

On a given PDCH a mobile station having been assigned an MS\_ID is identified with a TFI value including the MBMS Bearer Identity (in the most significant bit(s) of the TFI field) and the MS\_ID (in the remaining least significant bit(s) of the TFI field).

The mobile station shall respond with a PACKET CONTROL ACKNOWLEDGEMENT message in the uplink radio block specified if a valid RRBP field is received as part of the MBMS MS\_ID ASSIGNMENT message. The network shall reset counter N3109 for that MS\_ID on that MBMS radio bearer when transmitting for the first time the MBMS MS\_ID ASSIGNMENT message including a polling request. If the network does not receive the PACKET CONTROL ACKNOWLEDGEMENT message in the specified radio block, it shall increment counter N3109 for that MS\_ID and may retransmit the MBMS MS\_ID ASSIGNMENT message. If  $N3109 = N3109\_MAX$ , the network shall start timer T3199 for that MS\_ID. While T3199 is running for a given MS\_ID and MBMS radio bearer, the network shall not use that MS\_ID in any RLC/MAC block belonging to that MBMS radio bearer. When timer T3199 expires, the network may reuse the corresponding MS\_ID value for that MBMS radio bearer.

An initial timing advance value may be provided in the MBMS ASSIGNMENT message or in the MBMS MS\_ID ASSIGNMENT message in the *Packet Timing Advance* IE. Thereafter either the timing advance is updated with a PACKET POWER CONTROL/TIMING ADVANCE message or the continuous timing advance procedure is used. If timing advance timeslot number and index are provided in the MBMS ASSIGNMENT message or in the MBMS

MS\_ID ASSIGNMENT message, the mobile station shall use the continuous timing advance procedure, using its allocation on PTCCH (see 3GPP TS 45.010). Otherwise, the continuous timing advance procedure shall not be used. For the case where the timing advance value is not provided in the MBMS ASSIGNMENT message or in the MBMS MS\_ID ASSIGNMENT message, the mobile station is not allowed to send normal bursts (e.g. (EGPRS) PACKET DOWNLINK ACK/NACK message) on the uplink until it has received a valid timing advance either through the continuous timing advance procedure or in a PACKET POWER CONTROL/TIMING ADVANCE message.

If the mobile station has been assigned an MS\_ID in the MBMS ASSIGNMENT message before the point in time denoted by the MBMS radio bearer starting time, if present in the MBMS ASSIGNMENT message, the mobile station shall switch to the assigned PDCH(s) at the point in time denoted by the MBMS radio bearer starting time and start timers T3190 and T3290. If the MBMS radio bearer starting time has already expired or has not been included in the MBMS ASSIGNMENT message including the MS\_ID, the mobile station shall switch to the assigned PDCH(s) within the reaction time defined in 3GPP TS 45.010 and start timers T3190 and T3290. If the mobile station is assigned an MS\_ID in the MBMS MS\_ID ASSIGNMENT message, the mobile station shall start timer T3290 within the reaction time defined in 3GPP TS 45.010. The mobile station shall restart timer T3190 whenever receiving an RLC/MAC block including the assigned MBMS Bearer Identity. In EGPRS TBF mode T3190 is also restarted when receiving an erroneous RLC data block for which the header is correctly received and which addresses the mobile station. The mobile station with an assigned MS\_ID value shall restart timer T3290 whenever receiving an RLC/MAC block including the corresponding MBMS Bearer Identity and the MS\_ID in the TFI field.

### 7.7.3 MBMS Neighbour Cell Information Distribution

The network shall indicate in GPRS Cell Options IE whether it supports the distribution of MBMS NEIGHBOURING CELL INFORMATION messages (see sub-clause 12.24).

The network may send MBMS neighbour cell information to a mobile station during MBMS reception using the MBMS NEIGHBOURING CELL INFORMATION message on the PACCH. A mobile station, which receives this information, shall store the MBMS data channel information until refreshing or until the end of the MBMS session. During that period the information can be used for fast resumption of the MBMS reception in the neighbour cell (see sub-clause 8.1.6.2).

The MS shall only combine information received in several instances of the MBMS NEIGHBOURING CELL INFORMATION messages that have the same value of the MBMS\_PTM\_CHANGE\_MARK specified for a neighbouring cell.

In case the target cell has PBCCH allocated, this information shall be included in the MBMS NEIGHBOURING CELL INFORMATION message, if the PBCCH parameters can be encoded via the means provided in the message. If present, the MS shall use this information in order to avoid BCCH decoding, if not otherwise necessary unless the PBCCH location is known via PSI3 and PSI3bis messages, in the target cell.

In case in the target cell an MPRACH is allocated on the uplink feedback channel of an MBMS radio bearer, this information shall be included in the MBMS NEIGHBOURING CELL INFORMATION message.

# 8 Medium Access Control (MAC) Procedures in Packet Transfer Mode

## 8.0 General

The MAC procedures defined in this sub-clause are applicable in packet transfer mode. They are applicable in dual transfer mode, if both the network and the mobile station support DTM.

The procedures in this sub-clause (clause 8) shall not be used to change the frequency allocation of the carrier supporting the dedicated resources for the mobile station in dual transfer mode. None of the PACKET DOWNLINK ASSIGNMENT, the MULTIPLE TBF DOWNLINK ASSIGNMENT, the PACKET UPLINK ASSIGNMENT, the MULTIPLE TBF UPLINK ASSIGNMENT, the PACKET TIMESLOT RECONFIGURE or the MULTIPLE TBF TIMESLOT RECONFIGURE messages shall include frequency parameters for the carrier supporting the dedicated resources when they are sent to a mobile station in dual transfer mode.

NOTE: The network may use the DTM procedures on the main DCCH (the DTM ASSIGNMENT COMMAND message), if the radio resources for the RR connection and one or more TBF(s) need to be changed (see 3GPP TS 44.018).

## 8.1 Transfer of RLC data blocks

### 8.1.0 Medium access mode

The transfer of RLC data blocks is governed by different principles on both uplink and downlink for each of the defined medium access modes: dynamic allocation, extended dynamic allocation, and exclusive allocation.

The exclusive allocation is applicable only in dual transfer mode and MAC-DTM state and shall be used on a half-rate PDCH.

### 8.1.1 Uplink RLC data block transfer

For a TBF operating in BTTI configuration, prior to the initiation of RLC data block transfer on the uplink, the network assigns the following parameters to characterise the uplink TBF in the uplink assignment (e.g. PACKET UPLINK ASSIGNMENT, MULTIPLE TBF UPLINK ASSIGNMENT, PACKET TIMESLOT RECONFIGURE, MULTIPLE TBF TIMESLOT RECONFIGURE or PACKET CS RELEASE INDICATION) message:

- a Temporary Flow Identity (TFI). The mobile station shall set the TFI field of each uplink RLC data block to the TFI value assigned:
  - to the mobile station for that uplink TBF,
  - or in case EMST is used, to the TFI value assigned to the corresponding RLC entity on that uplink TBF,
  - or in case EMSR is enabled for an RLC entity, to each PFC supported by that RLC entity on the uplink TBF;
- a set of PDCHs to be used for the uplink transfer;
- a TBF Starting Time indication (optional in case of a dynamic or extended dynamic allocation and not applicable for dual carrier, multi carrier, BTTI with FANR activated, and EGPRS2 configurations);
- the PFI associated with each allocated TBF if the network and the mobile station both support multiple TBF procedures, or in case EMST is used, the PFI associated with each RLC entity on the allocated TBF, or in case EMSR is enabled for one or more RLC entities of the allocated TBF, the PFI associated with each PFC supported by these RLC entities.

In case the RTTI configuration is supported by the network and the mobile station and an uplink TBF operating in RTTI configuration is assigned, the following parameters shall be provided by the network in the assignment message (e.g.

PACKET UPLINK ASSIGNMENT, MULTIPLE TBF UPLINK ASSIGNMENT, PACKET TIMESLOT RECONFIGURE, MULTIPLE TBF TIMESLOT RECONFIGURE or PACKET CS RELEASE INDICATION).

- a Temporary Flow Identity (TFI). The mobile station shall set the TFI field of each uplink RLC data block to the TFI value assigned:
  - to the mobile station for that uplink TBF,
  - or in case EMST is used, to the TFI value assigned to the corresponding RLC entity on that uplink TBF,
  - or in case EMSR is enabled for an RLC entity, to each PFC supported by that RLC entity on the uplink TBF;
- one or more PDCH-pairs to be used for the uplink transfer;
- the PFI associated with each allocated TBF if the network and the mobile station both support multiple TBF procedures, or in case EMST is used, the PFI associated with each RLC entity on the allocated TBF, or in case EMSR is enabled for one or more RLC entities of the allocated TBF, the PFI associated with each PFC supported by these RLC entities;
- BTTI USF or RTTI USF mode to be used when receiving USFs.

For each PDCH-pair forming part of an assignment for an uplink TBF operating in RTTI configuration, the network may additionally assign a corresponding downlink PDCH-pair which shall be monitored by the mobile station for the USF (see sub-clause 7.1.3.6).

The network may, at any time during uplink packet transfer, change the TTI configuration or USF mode (BTTI USF mode or RTTI USF mode) as well as the corresponding downlink PDCH-pairs of an already established uplink TBF by sending on the downlink PACCH, an uplink TBF assignment message (e.g. PACKET UPLINK ASSIGNMENT, MULTIPLE TBF UPLINK ASSIGNMENT, PACKET TIMESLOT RECONFIGURE, MULTIPLE TBF TIMESLOT RECONFIGURE or PACKET CS RELEASE INDICATION). The mobile station shall begin using the new parameters within the reaction time defined in 3GPP TS 45.010.

In a Downlink Dual Carrier configuration, one or more PDCHs are assigned to a single mobile station on each of two different radio frequency channels. In a DLMC configuration, one or more PDCHs are assigned to a single mobile station on one or more of the uplink radio frequency channels that correspond to the downlink radio frequency channels assigned for the DLMC configuration. A mobile station with a Downlink Dual Carrier configuration or a DLMC configuration shall not be allocated radio blocks on multiple radio frequency channels during any given radio block period.

All the RLC data blocks of an uplink TBF initiated by one phase access shall each contain a TLLI (in *A/Gb mode*) or a G-RNTI (in *Iu mode*) field in the RLC data block header until the contention resolution is completed on the mobile station side (see sub-clause 7.1.2.3 and 3GPP TS 44.160). After the reaction time specified in 3GPP TS 45.010 no other RLC data blocks shall contain a TLLI field (in *A/Gb mode*) or a G-RNTI (in *Iu mode*), except for those retransmitted RLC data blocks that originally contained a TLLI (in *A/Gb mode*) or a G-RNTI (in *Iu mode*), which will be repeated including the same TLLI (in *A/Gb mode*) or G-RNTI (in *Iu mode*) (see sub-clause 7.1.2.3a and 3GPP TS 44.160). The TLLI\_BLOCK\_CHANNEL\_CODING parameter in the PACKET UPLINK ASSIGNMENT or in the MULTIPLE TBF UPLINK ASSIGNMENT message indicates whether a RLC data block containing a TLLI (in *A/Gb mode*) or a G-RNTI (in *Iu mode*) field in the RLC data block header shall be encoded using CS-1 in GPRS TBF mode, or MCS-1 in EGPRS TBF mode, or using the commanded modulation and channel coding scheme (see 3GPP TS 45.003). In GPRS TBF mode, the mobile station shall send all other RLC data blocks using the commanded channel coding scheme.

In EGPRS TBF mode, RLC data blocks that are transmitted for the first time shall be transmitted with the commanded MCS, except if the commanded mode is MCS-5-7, in which case the data block shall be transmitted with MCS-5, or if the commanded mode is MCS-6-9, in which case the data block shall be transmitted with MCS-6. In the case of a Downlink Dual Carrier configuration or a DLMC configuration the commanded MCS shall apply to all of the uplink carriers for which PDCH resources have been assigned. In EGPRS TBF mode, a MS may choose an alternate MCS than the one commanded, for the initial transmission of the last RLC data blocks of the TBF under the following conditions:

- the alternate MCS is more robust than the commanded MCS;
- the alternate MCS has already been commanded by the network during the TBF or was available for selection by the MS during the TBF according to the MCS selection rules for retransmissions; and
- the TBF requires no more radio blocks for initial transmission of the RLC data blocks using the alternate MCS than would be required when using the commanded MCS.



For a TBF with FANR activated, if the commanded MCS is MCS-9 (respectively MCS-4), the initial transmission of the RLC data block(s) shall be done with MCS-8 (respectively MCS-3) if a PAN field is included in the radio block.

When EMST is used, the commanded MCS shall apply to the RLC entity on the TBF identified by the TFI included in the header of the RLC/MAC block.

A RESEGMENT bit is included within each PACKET UPLINK ACK/NACK, PACKET UPLINK ASSIGNMENT, MULTIPLE TBF UPLINK ASSIGNMENT, PACKET TIMESLOT RECONFIGURE, MULTIPLE TBF TIMESLOT RECONFIGURE or PACKET CS RELEASE INDICATION messages. For initial transmissions of new RLC blocks the channel coding commanded is applied. The RESEGMENT bit is used to set the ARQ mode to type I or type II (incremental redundancy) for uplink TBFs. For retransmissions, setting the RESEGMENT bit to '1' (type I ARQ) requires the mobile station to use an MCS within the same family as the initial transmission and the payload may be split (refer to table 8.1.1.1). For retransmissions, setting the RESEGMENT bit to '0' (type II ARQ) requires the mobile station to use an MCS within the same family as the initial transmission without splitting the payload even if the network has commanded it to use MCS-1, MCS-2 or MCS-3 for subsequent RLC blocks (refer to table 8.1.1.2), see note. In RLC unacknowledged mode, RESEGMENT bit shall be ignored and default value 0 should be used.

NOTE: This bit is particularly useful for networks with uplink IR capability since it allows combining on retransmissions.

**Table 8.1.1.1: Choice of MCS for retransmissions with re-segmentation (EGPRS)**

Scheme used for initial transmission	Scheme to use for retransmissions after switching to a different MCS										
	MCS-9 Commanded	MCS-8 Commanded	MCS-7 Commanded	MCS-6-9 Commanded	MCS-6 Commanded	MCS-5-7 Commanded	MCS-5 Commanded	MCS-4 Commanded	MCS-3 Commanded	MCS-2 Commanded	MCS-1 Commanded
MCS-9	MCS-9	MCS-6	MCS-6	MCS-6	MCS-6	MCS-3	MCS-3	MCS-3	MCS-3	MCS-3	MCS-3
MCS-8	MCS-8	MCS-8	MCS-6 (pad)	MCS-6 (pad)	MCS-6 (pad)	MCS-3 (pad)	MCS-3 (pad)	MCS-3 (pad)	MCS-3 (pad)	MCS-3 (pad)	MCS-3 (pad)
MCS-7	MCS-7	MCS-7	MCS-7	MCS-5	MCS-5	MCS-5	MCS-5	MCS-2	MCS-2	MCS-2	MCS-2
MCS-6	MCS-9	MCS-6	MCS-6	MCS-9	MCS-6	MCS-3	MCS-3	MCS-3	MCS-3	MCS-3	MCS-3
MCS-5	MCS-7	MCS-7	MCS-7	MCS-5	MCS-5	MCS-3	MCS-5	MCS-2	MCS-2	MCS-2	MCS-2
MCS-4	MCS-4	MCS-4	MCS-4	MCS-4	MCS-4	MCS-4	MCS-4	MCS-4	MCS-1	MCS-1	MCS-1
MCS-3	MCS-3	MCS-3	MCS-3	MCS-3	MCS-3	MCS-3	MCS-3	MCS-3	MCS-3	MCS-3	MCS-3
MCS-2	MCS-2	MCS-2	MCS-2	MCS-2	MCS-2	MCS-2	MCS-2	MCS-2	MCS-2	MCS-2	MCS-2
MCS-1	MCS-1	MCS-1	MCS-1	MCS-1	MCS-1	MCS-1	MCS-1	MCS-1	MCS-1	MCS-1	MCS-1
NOTE:	MCS to use for retransmissions when re-segmentation (RESEGMENT bit set to "1") is carried out (specified as a function of the scheme used for the initial transmission).										

**Table 8.1.1.2: Choice of MCS for retransmissions without re-segmentation (EGPRS)**

Scheme used for Initial transmission	Scheme to use for retransmissions after switching to a different MCS										
	MCS-9 Commanded	MCS-8 Commanded	MCS-7 Commanded	MCS-6-9 Commanded	MCS-6 Commanded	MCS-5-7 Commanded	MCS-5 Commanded	MCS-4 Commanded	MCS-3 Commanded	MCS-2 Commanded	MCS-1 Commanded
	MCS-9 Commanded	MCS-8 Commanded	MCS-7 Commanded	MCS-6-9 Commanded	MCS-6 Commanded	MCS-5-7 Commanded	MCS-5 Commanded	MCS-4 Commanded	MCS-3 Commanded	MCS-2 Commanded	MCS-1 Commanded

MCS-9	MCS-9	MCS-6	MCS-6	MCS-6	MCS-6	MCS-6	MCS-6	MCS-6	MCS-6	MCS-6	MCS-6
MCS-8	MCS-8	MCS-8	MCS-6 (pad)	MCS-6 (pad)	MCS-6 (pad)	MCS-6 (pad)	MCS-6 (pad)	MCS-6 (pad)	MCS-6 (pad)	MCS-6 (pad)	MCS-6 (pad)
MCS-7	MCS-7	MCS-7	MCS-7	MCS-5	MCS-5	MCS-5	MCS-5	MCS-5	MCS-5	MCS-5	MCS-5
MCS-6	MCS-9	MCS-6	MCS-6	MCS-9	MCS-6	MCS-6	MCS-6	MCS-6	MCS-6	MCS-6	MCS-6
MCS-5	MCS-7	MCS-7	MCS-7	MCS-5	MCS-5	MCS-5	MCS-5	MCS-5	MCS-5	MCS-5	MCS-5
MCS-4	MCS-4	MCS-4	MCS-4	MCS-4	MCS-4	MCS-4	MCS-4	MCS-4	MCS-4	MCS-4	MCS-4
MCS-3	MCS-3	MCS-3	MCS-3	MCS-3	MCS-3	MCS-3	MCS-3	MCS-3	MCS-3	MCS-3	MCS-3
MCS-2	MCS-2	MCS-2	MCS-2	MCS-2	MCS-2	MCS-2	MCS-2	MCS-2	MCS-2	MCS-2	MCS-2
MCS-1	MCS-1	MCS-1	MCS-1	MCS-1	MCS-1	MCS-1	MCS-1	MCS-1	MCS-1	MCS-1	MCS-1
NOTE:	MCS to use for retransmissions when re-segmentation is not (RESEGMENT bit set to "0") allowed (specified as a function of the scheme used for the initial transmission).										

**Table 8.1.1.3: Choice of modulation and coding scheme for retransmissions with re-segmentation (EGPRS2-A)**

Scheme used for Initial transmission	Scheme to use for retransmissions after switching to a different modulation and coding scheme (MCS or UAS)										
	UAS-11 Commanded	UAS-10 Commanded	UAS-9 Commanded	UAS-8 Commanded	UAS-7 Commanded	MCS-6 Commanded	MCS-5 Commanded	MCS-4 Commanded	MCS-3 Commanded	MCS-2 Commanded	MCS-1 Commanded
UAS-11	UAS-11	UAS-8	UAS-8	UAS-8	MCS-6 (pad)	MCS-6 (pad)	MCS-3 (pad)	MCS-3 (pad)	MCS-3 (pad)	MCS-3 (pad)	MCS-3 (pad)
UAS-10	UAS-10	UAS-10	UAS-7	UAS-7	UAS-7	MCS-5	MCS-5	MCS-2	MCS-2	MCS-2	MCS-2
UAS-9	UAS-9	UAS-9	UAS-9	MCS-6	MCS-6	MCS-6	MCS-3	MCS-3	MCS-3	MCS-3	MCS-3
UAS-8	UAS-11	UAS-8	UAS-8	UAS-8	MCS-6 (pad)	MCS-6 (pad)	MCS-3 (pad)	MCS-3 (pad)	MCS-3 (pad)	MCS-3 (pad)	MCS-3 (pad)
UAS-7	UAS-10	UAS-10	UAS-7	UAS-7	UAS-7	MCS-5	MCS-5	MCS-2	MCS-2	MCS-2	MCS-2
MCS-6	UAS-9	UAS-9	UAS-9	MCS-6	MCS-6	MCS-6	MCS-3	MCS-3	MCS-3	MCS-3	MCS-3
MCS-5	UAS-10	UAS-10	UAS-7	UAS-7	UAS-7	MCS-5	MCS-5	MCS-2	MCS-2	MCS-2	MCS-2
MCS-4	MCS-4	MCS-4	MCS-4	MCS-4	MCS-4	MCS-4	MCS-4	MCS-4	MCS-1	MCS-1	MCS-1
MCS-3	MCS-3	MCS-3	MCS-3	MCS-3	MCS-3	MCS-3	MCS-3	MCS-3	MCS-3	MCS-3	MCS-3
MCS-2	MCS-2	MCS-2	MCS-2	MCS-2	MCS-2	MCS-2	MCS-2	MCS-2	MCS-2	MCS-2	MCS-2
MCS-1	MCS-1	MCS-1	MCS-1	MCS-1	MCS-1	MCS-1	MCS-1	MCS-1	MCS-1	MCS-1	MCS-1

**Table 8.1.1.4: Choice of modulation and coding scheme for retransmissions without re-segmentation (EGPRS2-A)**

Scheme used for Initial transmission	Scheme to use for retransmissions after switching to a different modulation and coding scheme (MCS or UAS)										
	UAS-11 Commanded	UAS-10 Commanded	UAS-9 Commanded	UAS-8 Commanded	UAS-7 Commanded	MCS-6 Commanded	MCS-5 Commanded	MCS-4 Commanded	MCS-3 Commanded	MCS-2 Commanded	MCS-1 Commanded
UAS-11	UAS-11	UAS-8	UAS-8	UAS-8	MCS-6 (pad)	MCS-6 (pad)	MCS-6 (pad)	MCS-6 (pad)	MCS-6 (pad)	MCS-6 (pad)	MCS-6 (pad)
UAS-10	UAS-10	UAS-10	UAS-7	UAS-7	UAS-7	MCS-5	MCS-5	MCS-5	MCS-5	MCS-5	MCS-5
UAS-9	UAS-9	UAS-9	UAS-9	MCS-6	MCS-6	MCS-6	MCS-6	MCS-6	MCS-6	MCS-6	MCS-6
UAS-8	UAS-11	UAS-8	UAS-8	UAS-8	MCS-6 (pad)	MCS-6 (pad)	MCS-6 (pad)	MCS-6 (pad)	MCS-6 (pad)	MCS-6 (pad)	MCS-6 (pad)
UAS-7	UAS-10	UAS-10	UAS-7	UAS-7	UAS-7	MCS-5	MCS-5	MCS-5	MCS-5	MCS-5	MCS-5
MCS-6	UAS-9	UAS-9	UAS-9	MCS-6	MCS-6	MCS-6	MCS-6	MCS-6	MCS-6	MCS-6	MCS-6
MCS-5	UAS-10	UAS-10	UAS-7	UAS-7	UAS-7	MCS-5	MCS-5	MCS-5	MCS-5	MCS-5	MCS-5
MCS-4	MCS-4	MCS-4	MCS-4	MCS-4	MCS-4	MCS-4	MCS-4	MCS-4	MCS-4	MCS-4	MCS-4
MCS-3	MCS-3	MCS-3	MCS-3	MCS-3	MCS-3	MCS-3	MCS-3	MCS-3	MCS-3	MCS-3	MCS-3
MCS-2	MCS-2	MCS-2	MCS-2	MCS-2	MCS-2	MCS-2	MCS-2	MCS-2	MCS-2	MCS-2	MCS-2
MCS-1	MCS-1	MCS-1	MCS-1	MCS-1	MCS-1	MCS-1	MCS-1	MCS-1	MCS-1	MCS-1	MCS-1

**Table 8.1.1.5: Choice of modulation and coding scheme for retransmissions with re-segmentation (EGPRS2-B)**

Scheme used for Initial transmission	Scheme to use for retransmissions after switching to a different modulation and coding scheme (MCS or UBS)											
	UBS-12 Commanded	UBS-11 Commanded	UBS-10 Commanded	UBS-9 Commanded	UBS-8 Commanded	UBS-7 Commanded	UBS-6 Commanded	UBS-5 Commanded	MCS-4 Commanded	MCS-3 Commanded	MCS-2 Commanded	MCS-1 Commanded
UBS-12	UBS-12	UBS-10	UBS-10	UBS-8	UBS-8	UBS-6	UBS-6	MCS-3	MCS-3	MCS-3	MCS-3	MCS-3
UBS-11	UBS-11	UBS-11	UBS-10 (pad)	UBS-8 (pad)	UBS-8 (pad)	UBS-6 (pad)	UBS-6 (pad)	MCS-3 (pad)	MCS-3 (pad)	MCS-3 (pad)	MCS-3 (pad)	MCS-3 (pad)
UBS-10	UBS-12	UBS-10	UBS-10	UBS-8	UBS-8	UBS-6	UBS-6	MCS-3	MCS-3	MCS-3	MCS-3	MCS-3
UBS-9	UBS-9	UBS-9	UBS-9	UBS-9	UBS-7	UBS-7	UBS-5	UBS-5	MCS-2	MCS-2	MCS-2	MCS-2
UBS-8	UBS-12	UBS-10	UBS-10	UBS-8	UBS-8	UBS-6	UBS-6	MCS-3	MCS-3	MCS-3	MCS-3	MCS-3
UBS-7	UBS-9	UBS-9	UBS-9	UBS-9	UBS-7	UBS-7	UBS-5	UBS-5	MCS-2	MCS-2	MCS-2	MCS-2
UBS-6	UBS-12	UBS-10	UBS-10	UBS-8	UBS-8	UBS-6	UBS-6	MCS-3	MCS-3	MCS-3	MCS-3	MCS-3
UBS-5	UBS-9	UBS-9	UBS-9	UBS-9	UBS-7	UBS-7	UBS-5	UBS-5	MCS-2	MCS-2	MCS-2	MCS-2
MCS-4	MCS-4	MCS-4	MCS-4	MCS-4	MCS-4	MCS-4	MCS-4	MCS-4	MCS-4	MCS-4	MCS-4	MCS-4
MCS-3	MCS-3	MCS-3	MCS-3	MCS-3	MCS-3	MCS-3	MCS-3	MCS-3	MCS-3	MCS-3	MCS-3	MCS-3
MCS-2	MCS-2	MCS-2	MCS-2	MCS-2	MCS-2	MCS-2	MCS-2	MCS-2	MCS-2	MCS-2	MCS-2	MCS-2
MCS-1	MCS-1	MCS-1	MCS-1	MCS-1	MCS-1	MCS-1	MCS-1	MCS-1	MCS-1	MCS-1	MCS-1	MCS-1

**Table 8.1.1.6: Choice of modulation and coding scheme for retransmissions without re-segmentation (EGPRS2-B)**

Scheme used for Initial transmission	Scheme to use for retransmissions after switching to a different modulation and coding scheme (MCS or UBS)											
	UBS-12 Commanded	UBS-11 Commanded	UBS-10 Commanded	UBS-9 Commanded	UBS-8 Commanded	UBS-7 Commanded	UBS-6 Commanded	UBS-5 Commanded	MCS-4 Commanded	MCS-3 Commanded	MCS-2 Commanded	MCS-1 Commanded
UBS-12	UBS-12	UBS-10	UBS-10	UBS-8	UBS-8	UBS-6	UBS-6	UBS-6	UBS-6	UBS-6	UBS-6	UBS-6
UBS-11	UBS-11	UBS-11	UBS-10 (pad)	UBS-8 (pad)	UBS-8 (pad)	UBS-6 (pad)	UBS-6 (pad)	UBS-6 (pad)	UBS-6 (pad)	UBS-6 (pad)	UBS-6 (pad)	UBS-6 (pad)
UBS-10	UBS-12	UBS-10	UBS-10	UBS-8	UBS-8	UBS-6	UBS-6	UBS-6	UBS-6	UBS-6	UBS-6	UBS-6
UBS-9	UBS-9	UBS-9	UBS-9	UBS-9	UBS-7	UBS-7	UBS-5	UBS-5	UBS-5	UBS-5	UBS-5	UBS-5
UBS-8	UBS-12	UBS-10	UBS-10	UBS-8	UBS-8	UBS-6	UBS-6	UBS-6	UBS-6	UBS-6	UBS-6	UBS-6
UBS-7	UBS-9	UBS-9	UBS-9	UBS-9	UBS-7	UBS-7	UBS-5	UBS-5	UBS-5	UBS-5	UBS-5	UBS-5
UBS-6	UBS-12	UBS-10	UBS-10	UBS-8	UBS-8	UBS-6	UBS-6	UBS-6	UBS-6	UBS-6	UBS-6	UBS-6
UBS-5	UBS-9	UBS-9	UBS-9	UBS-9	UBS-7	UBS-7	UBS-5	UBS-5	UBS-5	UBS-5	UBS-5	UBS-5
MCS-4	MCS-4	MCS-4	MCS-4	MCS-4	MCS-4	MCS-4	MCS-4	MCS-4	MCS-4	MCS-4	MCS-4	MCS-4
MCS-3	MCS-3	MCS-3	MCS-3	MCS-3	MCS-3	MCS-3	MCS-3	MCS-3	MCS-3	MCS-3	MCS-3	MCS-3
MCS-2	MCS-2	MCS-2	MCS-2	MCS-2	MCS-2	MCS-2	MCS-2	MCS-2	MCS-2	MCS-2	MCS-2	MCS-2
MCS-1	MCS-1	MCS-1	MCS-1	MCS-1	MCS-1	MCS-1	MCS-1	MCS-1	MCS-1	MCS-1	MCS-1	MCS-1

In EGPRS, if these rules require a transmission (either original transmission or retransmission) in a) MCS-7 or b) MCS-8 or c) MCS-9, but there is only one RLC block that can be transmitted in that MCS, the MS shall send that block in either MCS-5 for case a) or MCS-6 for case b) or case c). In case b), padding is permitted.

In EGPRS2, if these rules require a transmission (either original transmission or retransmission) in a modulation and coding scheme where there are fewer than the maximum number of RLC blocks that can be transmitted, the mobile station shall use the modulation and coding scheme specified in tables 8.1.1.7 and 8.1.1.8.

**Table 8.1.1.7: Retransmissions with fewer RLC blocks (EGPRS2-A)**

Modulation and Coding Scheme specified	Modulation/Coding scheme to be used (only 1 block can be transmitted)	Modulation/Coding scheme to be used (only 2 blocks can be transmitted)
UAS-7	MCS-5	n/a
UAS-8	MCS-6 (with padding)	n/a
UAS-9	MCS-6	n/a
UAS-10	MCS-5	UAS-7
UAS-11	MCS-6 (with padding)	UAS-8

**Table 8.1.1.8: Retransmissions with fewer RLC blocks (EGPRS2-B)**

Modulation and Coding Scheme Specified	Modulation/Coding scheme to be used (only 1 block can be transmitted)	Modulation/Coding scheme to be used (only 2 blocks can be transmitted)	Modulation/Coding scheme to be used (only 3 blocks can be transmitted)
UBS-7	UBS-5	n/a	n/a
UBS-8	UBS-6	n/a	n/a
UBS-9	UBS-5	UBS-7	n/a
UBS-10	UBS-6	UBS-8	n/a
UBS-11	UBS-6 (with padding)	UBS-8 (with padding)	UBS-10 (with padding)
UBS-12	UBS-6	UBS-8	UBS-10

Modulation and coding schemes to be used for retransmissions after a transition from EGPRS to EGPRS2-A or EGPRS2-B or from EGPRS2-A or EGPRS2-B to EGPRS are specified in sub-clause 8.1.1.7.2.

For a TBF with FANR activated, if these rules require a retransmission in MCS-9 and a PAN field is included in an EGPRS RLC/MAC block for data transfer, the mobile station shall use MCS-6. If these rules require a retransmission in MCS-4, a PAN field is to be included in an EGPRS RLC/MAC block for data transfer and re-segmentation is allowed, the mobile station shall use MCS-1. If these rules require a retransmission in MCS-4 and re-segmentation is not allowed, the mobile station shall use MCS-4 and shall not include a PAN field in this retransmission.

Upon receipt of a command from the network to change channel coding scheme, the mobile station shall react in accordance with the time specified in 3GPP TS 45.010.

Upon receipt of any message containing an uplink assignment (e.g. PACKET UPLINK ASSIGNMENT, MULTIPLE TBF UPLINK ASSIGNMENT, PACKET TIMESLOT RECONFIGURE, MULTIPLE TBF TIMESLOT RECONFIGURE, PACKET UPLINK ACK/NACK or PACKET CS RELEASE INDICATION message), the mobile station shall be ready to transmit in accordance with the requirements given in 3GPP TS 45.010.

The mobile station shall transmit RLC/MAC blocks with the following priority:

- RLC/MAC control blocks containing a PACKET CS REQUEST message;
- RLC/MAC control blocks containing a PACKET CELL CHANGE NOTIFICATION message;
- Other RLC/MAC control blocks, except
  - Packet Uplink Dummy Control Blocks; and
  - RLC/MAC control block containing an EGPRS PACKET DOWNLINK ACK/NACK or EGPRS PACKET DOWNLINK ACK/NACK TYPE 2 or EGPRS PACKET DOWNLINK ACK/NACK TYPE 3 or EGPRS PACKET DOWNLINK ACK/NACK DLMC message, when the mobile station is polled for a PAN (see sub-clause 10.4.4a);
- RLC data blocks (including a PAN field if required. See sub-clauses 8.1.2.2, 9.1.8.2.1 and 9.1.14.3.) except RLC data blocks including a PAN which is sent in response to a poll where all the element(s) of V(B) have the value TENTATIVE\_ACK or ACKED;
- when the mobile station is polled for a PAN (see sub-clause 10.4.4a), RLC/MAC control block containing an EGPRS PACKET DOWNLINK ACK/NACK or EGPRS PACKET DOWNLINK ACK/NACK TYPE 2 or

EGPRS PACKET DOWNLINK ACK/NACK TYPE 3 or EGPRS PACKET DOWNLINK ACK/NACK DLMC message;

- RLC data block including a PAN which is sent in response to a poll where all the elements of V(B) have the value TENTATIVE\_ACK or ACKED;
- RLC/MAC control blocks containing Packet Uplink Dummy Control Blocks.

If an uplink TBF operating in MTTI configuration and operating in EGPRS RLC acknowledged mode is allocated RTTI and BTTI radio blocks whose transmissions start in the same TDMA frame, the mobile station shall determine which (if any) RLC data blocks to transmit on the RTTI resources according to the above rules and those in sub-clause 9.1.3.2.1 before determining which (if any) RLC data blocks to transmit on the BTTI resources, regardless of the relative numbering of the timeslots used for the RTTI and BTTI resources.

NOTE: Within the respective reaction times specified in 3GPP TS 45.010 at uplink assignment, change of coding scheme and completion of the contention resolution at one phase access, the mobile station may send RLC/MAC control blocks containing Packet Uplink Dummy Control Blocks, if there is no other block ready to be transmitted.

In *A/Gb mode*, during the TBF, if the countdown procedure has not started or the TBF is operated in the extended uplink TBF mode (see sub-clause 9.3.1b) and multiple TBF procedures are not supported (i.e. the mobile station or the network does not support multiple TBF procedures) the mobile station shall ask for new or different radio resources, by sending a PACKET RESOURCE REQUEST message (sub-clauses 8.1.1.1.2), in the following cases;

- When the mobile station has indicated Page Response, Cell update or Mobility Management procedure as access type in the PACKET CHANNEL REQUEST message and it has data to send;
- When the mobile station has data to send with a lower priority than indicated in the PACKET CHANNEL REQUEST or EGPRS PACKET CHANNEL REQUEST message;
- When the mobile station has indicated 'Signalling' as access type in the EGPRS PACKET CHANNEL REQUEST message and it has data to send.

In *A/Gb mode* or *Iu mode*, a mobile station that supports multiple TBF procedures shall send a PACKET RESOURCE REQUEST message to a network supporting multiple TBF procedures (see sub-clause 8.1.1.1.2), if it has data to send for one or more PFCs (*A/Gb mode*) or RBs (*Iu mode*) for which no uplink TBFs are established.

### 8.1.1.1 Dynamic allocation uplink RLC data block transfer

This sub-clause specifies mobile station behaviour for dynamic allocation uplink RLC data block transfer while in packet transfer mode, MAC-Shared State, dual transfer mode or MAC-DTM state.

When the mobile station receives an uplink assignment (e.g. PACKET UPLINK ASSIGNMENT, MULTIPLE TBF UPLINK ASSIGNMENT, PACKET TIMESLOT RECONFIGURE, MULTIPLE TBF TIMESLOT RECONFIGURE or PACKET CS RELEASE INDICATION message) that does not contain a TBF starting time, if the uplink TBF is assigned in BTTI configuration the mobile station shall begin monitoring the downlink PDCHs corresponding to (i.e. with the same timeslot number as) the assigned uplink PDCHs for the assigned USF value for each assigned uplink PDCH within the reaction time defined in 3GPP TS 45.010. Alternatively, if the uplink TBF is assigned in RTTI configuration, the mobile station shall begin monitoring the downlink PDCH-pairs corresponding to the assigned uplink PDCH-pairs for the assigned USF value within the reaction time defined in 3GPP TS 45.010. If a TBF starting time information element is present and no uplink TBFs are in progress, but one or more downlink TBFs are in progress, the mobile station shall wait until the starting time before beginning to monitor the USFs and using the newly assigned uplink TBF parameters. While waiting for the starting time, the mobile station shall monitor the assigned downlink PDCHs. If a TBF starting time information element is present and one or more uplink TBFs are already in progress, the mobile station shall continue to use the assigned parameters of the ongoing uplink TBFs until the TDMA frame number indicated by the TBF starting time occurs, at which time the mobile station shall immediately begin to use the newly assigned uplink TBF parameters. The mobile station shall continue to use the newly assigned parameters of each uplink TBF until the TBF is either released or reconfigured. If while waiting for the frame number indicated by the TBF starting time the mobile station receives another uplink assignment, the mobile station shall act upon the most recently received uplink assignment and shall ignore the previous uplink assignment.

If a mobile station has requested multiple uplink TBFs in a PACKET RESOURCE REQUEST message, the network may allocate resources for these TBFs by sending one or more uplink assignment messages in response (see sub-clause 8.1.1.1.2). The mobile station shall act upon each successive uplink assignment message as it is received.

A mobile station that has a TBF operating in BTTI configuration shall monitor all the downlink PDCHs corresponding to the assigned uplink PDCHs except if the mobile station is in DTR mode (see sub-clause 8.1.8). When operating a TBF in RTTI configuration, the mobile station shall monitor the corresponding downlink PDCH-pairs associated with the assigned uplink PDCH-pairs that can be monitored according to the number of allocated uplink PDCH-pairs and its multislot capabilities except if the mobile station is in DTR mode (see sub-clause 8.1.8).

Whenever the mobile station detects an assigned USF value on a monitored downlink PDCH or PDCH-pair, the mobile station shall transmit either a single RLC/MAC block or a sequence of four RLC/MAC blocks on the same PDCH or corresponding PDCH-pair for that TBF except if that TBF is running in extended uplink TBF mode, in which case the mobile station may transmit RLC/MAC block(s) for other TBFs assigned on the same PDCH or corresponding PDCH-pair (see sub-clause 9.3.1b.2). The time relation between an uplink block, which the mobile station shall use for transmission, and the occurrence of the USF value is defined in 3GPP TS 45.002. The number of RLC/MAC blocks to transmit is controlled by the USF\_GRANULARITY parameter characterising the uplink TBF.

For a mobile station with an uplink TBF for which EFTA is used transmissions shall be performed on the uplink PDCHs or PDCH-pairs allocated by the USF as specified in Annex N. In case the mobile station also has one or more concurrent downlink TBF(s), but does not have enough RLC/MAC blocks ready for transmission to fully utilize the total number of allocated resources for uplink radio block transmission during the corresponding radio block period(s), then it shall immediately begin monitoring its assigned downlink PDCHs or PDCH-pairs after transmitting its last available RLC/MAC block taking into account the switching requirements of its multislot class (see 3GPP TS 45.002).

An uplink TBF operating in RTTI configuration may receive the assigned USFs either in RTTI USF mode or BTTI USF mode. The USF mode is indicated during the assignment of the corresponding uplink TBF.

For an uplink TBF in RTTI configuration that receives the USFs in BTTI USF mode:

- An assigned USF received on the first PDCH of a monitored downlink PDCH-pair allocates resources for one or four uplink RTTI radio blocks in the first two TDMA frames of the following basic radio block period(s) on the corresponding uplink PDCH-pair, depending on the value of USF\_GRANULARITY.
- An assigned USF received on the second PDCH of a monitored downlink PDCH-pair allocates resources for one or four uplink RTTI radio blocks in the second two TDMA frames of the following basic radio block period(s) on the corresponding uplink PDCH-pair, depending on the value of USF\_GRANULARITY.

For an uplink TBF in RTTI configuration that receives the USFs in RTTI USF mode:

- An assigned USF received on a monitored downlink PDCH-pair in the first reduced radio block period of a given basic radio block period allocates resources for one or four uplink RTTI radio blocks in the second reduced radio block period starting in the same basic radio block period and continuing with the second reduced radio block period in the following basic radio block periods on the corresponding uplink PDCH-pair, depending on the value of USF\_GRANULARITY.
- An assigned USF received on a monitored downlink PDCH-pair in the second reduced radio block period of a given basic radio block period allocates resources for one or four uplink RTTI radio blocks in the first reduced radio block period starting in the next basic radio block period and continuing with the first reduced radio block period in the following basic radio block periods on the corresponding uplink PDCH-pair, depending on the value of USF\_GRANULARITY.

The time relation between the uplink radio block(s) which the mobile station shall use for transmission and the occurrence of the USF value is further defined in 3GPP TS 45.002

In a Downlink Dual Carrier configuration, one or more PDCHs are assigned to a single mobile station on each of two different radio frequency channels. In a DLMC configuration, one or more PDCHs are assigned to a single mobile station on one or more of the uplink radio frequency channels that correspond to the downlink radio frequency channels assigned for the DLMC configuration. A mobile station with a Downlink Dual Carrier configuration or a DLMC configuration shall not be allocated radio blocks on more than one radio frequency channel during any given radio block period.

When the mobile station transmits an RLC/MAC block to the network, it shall start timer T3180 for the uplink TBF on which the block was sent. When the mobile station detects an assigned USF value on a downlink PDCH corresponding to an assigned uplink PDCH for that TBF, the mobile station shall restart timer T3180. If any given timer T3180 expires, the mobile station shall perform an abnormal release with access retry (see sub-clause 8.7.2 (*A/Gb mode*) or 3GPP TS 44.160 (*Iu mode*)).

Whenever the network receives a valid RLC/MAC block for any given TBF, it shall reset counter N3101 for that TBF. The network shall increment counter N3101 for each radio block, allocated to that TBF, for which no data is received. If  $N3101 = N3101_{max}$ , the network shall stop the scheduling of RLC/MAC blocks for that TBF and start timer T3169. When T3169 expires, the network may reuse the USF and TFI(s) assigned to that TBF. If PS Handover is ongoing it is optional for the network to increment N3101.

#### 8.1.1.1.1 PACCH operation

The mobile station shall attempt to decode every downlink RLC/MAC block on all the downlink PDCHs corresponding to (i.e. with the same timeslot number as) the assigned uplink PDCHs when the uplink TBF operates in BTTI configuration except if the mobile station is in DTR mode (see sub-clause 8.1.8).

In case the uplink TBF operates in RTTI configuration the mobile station shall attempt to decode every downlink RLC/MAC block on the corresponding downlink PDCH-pairs being monitored (see subclause 8.1.1.1) except if the mobile station is in DTR mode (see sub-clause 8.1.8).

Downlink PACCH blocks shall be received in the same TTI configuration as the assigned uplink TBF.

Whenever the mobile station receives an RLC/MAC block containing an RLC/MAC control block, the mobile station shall attempt to interpret the message contained therein. If the message addresses the mobile station, the mobile station shall act on the message.

Whenever a mobile station, that has an assigned uplink TBF operating in BTTI configuration, detects an assigned USF value on any downlink PDCH corresponding to an assigned uplink PDCH, the mobile station may transmit a PACCH block on the same PDCH in the next block period (see 3GPP TS 45.002). Whenever a mobile station, that has an assigned uplink TBF operating in RTTI configuration, detects an assigned USF value on any corresponding downlink PDCH-pair associated with an assigned uplink PDCH-pair, the mobile station may transmit a PACCH block on the PDCH-pair. The PACCH block shall be transmitted according to the USF scheduling in sub-clause 8.1.1.1. The mobile station shall not transmit an RLC data block in any uplink radio block allocated via the polling mechanism (see sub-clauses 10.4.4, 10.4.4a, 10.4.4b) unless the uplink TBF operates in either RTTI configuration, or in BTTI configuration with FANR activated, and the mobile station is polled for a Piggy-backed Ack/Nack (see sub-clause 10.4.4b).

In the case of a Downlink Dual Carrier configuration or a DLMC configuration, all segments belonging to each RLC/MAC control message shall be sent on PACCH blocks belonging to the same carrier.

When a mobile station in a DLMC configuration supporting more than 20 downlink timeslots sends an EGPRS Packet Downlink Ack/Nack DLMC message (see sub-clause 11.2.48) it shall be coded using CS-1 or CS-3 as indicated by the most recently received assignment message. Otherwise, if it supports 20 or less downlink timeslots, EGPRS Packet Downlink Ack/Nack DLMC messages shall be coded using CS-1.

#### 8.1.1.1.2 Resource Reallocation for Uplink

The mobile station and the network are not allowed to change the RLC mode nor TBF mode of an already established TBF during resource reallocation. Change of RLC mode or TBF mode shall be achieved through release of on-going TBF and establishment of a new TBF with the newly requested RLC mode or TBF mode. If a new mode is assigned by the network for an already established TBF, the MS shall ignore the new assigned mode and shall maintain the TBF in the old mode.

During an uplink packet transfer, upper layers may request to transfer another upper layer PDU with a different PFI, a different Radio Priority, a different peak throughput class or a different RLC mode than the one which is in transfer. An upper layer PDU containing signalling shall be treated as having the highest Radio Priority, an implementation specific peak throughput class and the acknowledged RLC mode shall be requested.

If the mobile station or the network does not support multiple TBF procedures the following procedures apply unless resource reallocation is not needed when EMSR is enabled (see sub-clause 5.12):

- If the mobile station has not started the countdown procedure or the TBF is operated in the extended uplink TBF mode (see sub-clause 9.3.1b) and the new upper layer PDU has the same RLC mode as the current uplink TBF, or in case EMST is used, the new upper layer PDU has the same RLC mode as any of the RLC entities allocated on the ongoing uplink TBF, and either a higher radio priority or the same radio priority but a higher peak throughput class, the mobile station shall immediately request a resource reallocation for uplink according to the new Radio Priority and peak throughput class of the new upper layer PDU by sending a PACKET RESOURCE REQUEST message on the PACCH and starting timer T3168 for the uplink TBF requested in the PACKET RESOURCE REQUEST message. Then the mobile station shall complete the transmission of the current upper layer PDU;
- If the new upper layer PDU has the same RLC mode as the current uplink TBF, or in case EMST is used, the new upper layer PDU has the same RLC mode as any of the RLC entities allocated to the ongoing uplink TBF, and either a lower Radio Priority or the same radio priority but a lower peak throughput class, the mobile station shall first complete the sending of the upper layer PDU in transfer. When the sending of upper layer PDUs at the higher Radio Priority or the same radio priority but higher peak throughput class stops, without waiting for the acknowledgement from the network if in RLC acknowledged mode, the mobile station shall then perform the request of a resource reallocation for uplink for any remaining upper layer PDU(s) by sending a PACKET RESOURCE REQUEST message on the PACCH and start timer T3168 for the uplink TBF requested in the PACKET RESOURCE REQUEST message. However if the upper layer PDUs at the higher Radio Priority does not completely fill the RLC data block the MS shall fill this RLC data block with payload from the new upper layer PDUs and then either transmit first the PACKET RESOURCE REQUEST message and subsequently the RLC data block or vice versa.
- If the mobile station or the network does not support EMST, and if the new upper layer PDU does not have the same RLC mode as the current uplink TBF but has a higher radio priority, the mobile station shall complete the transmission of the current upper layer PDU using the countdown procedure including acknowledgement from the network, if in RLC acknowledged mode. If the TBF is operated in non-extended uplink TBF mode, the mobile station shall then release the TBF and establish a new uplink TBF for transmission of the new upper layer PDU. If the TBF is operated in extended uplink TBF mode (see sub-clause 9.3.1b), the mobile station shall use the procedure in sub-clause 8.1.1.6 for changing the RLC mode. When the sending of upper layer PDUs with a higher radio priority is completed using the countdown procedure, including acknowledgement from the network if in RLC acknowledged mode, the mobile station shall try to establish an uplink TBF for the transmission of any remaining upper layer PDU(s);
- If both the mobile station and the network support EMST, the TBF is operated in extended uplink TBF mode, and the new upper layer PDU does not have the same RLC mode as any of the RLC entities allocated to the ongoing uplink TBF, the mobile station shall immediately request a resource reallocation for uplink according to the Radio Priority and peak throughput class of the new upper layer PDU by sending a PACKET RESOURCE REQUEST message on the PACCH and starting timer T3168 for the uplink TBF requested in the PACKET RESOURCE REQUEST message. Then the mobile station shall continue the transmission of the current upper layer PDU;



- If the mobile station has not started the countdown procedure or the TBF is operated in the extended uplink TBF mode (see sub-clause 9.3.1b) and the new upper layer PDU does not have the same PFI but has the same radio priority and the same peak throughput class as the current uplink TBF, or if EMST is used, as one of the current RLC entities, the mobile station shall immediately request a resource reallocation for uplink with the new PFI by sending a PACKET RESOURCE REQUEST message on the PACCH and starting timer T3168 for the uplink TBF requested in the PACKET RESOURCE REQUEST message. Then the mobile station shall complete the transmission of the current upper layer PDU.

If both the mobile station and the network support multiple TBF procedures the following procedures apply:

- The mobile station shall initiate a request for one or more new uplink TBFs when it has upper layer PDUs associated with one or more PFIs for which there are no ongoing uplink TBFs. In this case it sends a PACKET RESOURCE REQUEST message on the PACCH and starts an instance of timer T3168 for each uplink TBF requested;
- All ongoing uplink TBFs shall continue to operate using their currently allocated resources.

If both the network and the mobile station support the extended uplink TBF mode, the request from upper layers may indicate that the new upper-layer PDU is meant to pre-allocate an uplink TBF (early TBF establishment). In this case, the EARLY\_TBF\_ESTABLISHMENT field in the PACKET RESOURCE REQUEST message shall indicate pre-allocation is required.

On receipt of the PACKET RESOURCE REQUEST message the network shall respond by sending either an uplink assignment message (e.g. PACKET UPLINK ASSIGNMENT, MULTIPLE TBF UPLINK ASSIGNMENT, PACKET TIMESLOT RECONFIGURE or MULTIPLE TBF TIMESLOT RECONFIGURE) or a PACKET ACCESS REJECT message to the mobile station on the downlink PACCH. If the mobile station supports RLC non-persistent mode the network may allocate one or more EGPRS TBFs that use this RLC mode.

If the mobile station or the network does not support multiple TBF procedures, then after the transmission of the PACKET RESOURCE REQUEST message with the reason for changing PFI, the radio priority or peak throughput class of an assigned uplink TBF the mobile station shall continue to use the currently assigned uplink TBF assuming that the requested radio priority or peak throughput class is already assigned to that TBF.

If both the mobile station and the network support multiple TBF procedures, then after transmission of a PACKET RESOURCE REQUEST message the mobile station shall maintain its ongoing uplink TBFs using their currently allocated TBF parameters.

On receipt of an uplink assignment message (e.g. PACKET UPLINK ASSIGNMENT, MULTIPLE TBF UPLINK ASSIGNMENT, PACKET TIMESLOT RECONFIGURE or MULTIPLE TBF TIMESLOT RECONFIGURE message) sent in response to a PACKET RESOURCE REQUEST message the mobile station shall stop timer T3168 for each uplink TBF assigned in the assignment message and switch to the assigned PDCHs. A mobile station that supports multiple TBF procedures shall act on the uplink assignment message as defined in sub-clause 8.1.2.5.

If the mobile station or the network does not support multiple TBF procedures, the mobile station is then not allowed to send new PACKET RESOURCE REQUEST messages until either a new packet transfer request is received from the upper layers or when sending of upper layer PDU(s) at a lower Radio Priority has to be continued.

If the mobile station or the network does not support multiple TBF procedures, upon expiry of timer T3168 the mobile station shall retransmit the PACKET RESOURCE REQUEST message unless the PACKET RESOURCE REQUEST message has already been transmitted four times in which case the mobile station shall perform an abnormal release with access retry (see sub-clause 8.7.2).

If both the mobile station and the network support multiple TBF procedures, then upon expiry of all instances of timer T3168 the mobile station shall retransmit the PACKET RESOURCE REQUEST message to request resources for those uplink TBFs that did not receive an uplink assignment unless the PACKET RESOURCE REQUEST message has already been transmitted four times without receiving any uplink assignment in response. In this case the mobile station shall perform an abnormal release with access retry (see sub-clause 8.7.2).

If no assignment message (e.g. PACKET UPLINK ASSIGNMENT, MULTIPLE TBF UPLINK ASSIGNMENT, PACKET TIMESLOT RECONFIGURE or MULTIPLE TBF TIMESLOT RECONFIGURE message) addressing any requested uplink TBF is received before the mobile station has completed its currently assigned TBFs the mobile station shall stop all instances of timer T3168.

The network may at any time during uplink packet transfer initiate a change of resources by sending on the downlink PACCH monitored by the MS, an unsolicited uplink assignment message (e.g. PACKET UPLINK ASSIGNMENT, MULTIPLE TBF UPLINK ASSIGNMENT, PACKET TIMESLOT RECONFIGURE, MULTIPLE TBF TIMESLOT RECONFIGURE or PACKET CS RELEASE INDICATION message) to the mobile station. During the reallocation, TFI is allowed to be changed. A mobile station that supports multiple TBF procedures shall act on the uplink assignment message as defined in sub-clause 8.1.2.5.

When an uplink TBF is established in response to a PACKET RESOURCE REQUEST message with the EARLY\_TBF\_ESTABLISHMENT field set to indicate pre-allocation is required, a network supporting early TBF establishment should keep the uplink TBF open by means of the extended uplink TBF mode operation (see sub-clause 9.3.1b.2).

On receipt of a PACKET ACCESS REJECT message, the mobile station shall stop timer T3168, if running, for the TBFs rejected in the PACKET ACCESS REJECT message, abort the uplink TBFs and indicate a packet access failure to the upper layer associated with each rejected TBF. If no more uplink or downlink TBFs exist, the mobile station in packet transfer mode shall return to packet idle mode; the mobile station in dual transfer mode shall return to dedicated mode. The DRX mode procedures shall be applied, as specified in sub-clause 5.5.1.5.

If the PACKET ACCESS REJECT message contains a WAIT\_INDICATION field in a Reject structure addressed to the mobile station, the mobile station shall:

- If the mobile station or the network does not support multiple TBF procedures, start timer T3172 and if the mobile station has additional RLC data blocks to transmit, it shall initiate a new uplink TBF establishment, but the mobile station is not allowed to make a new attempt for an uplink TBF establishment in the same cell until timer T3172 expires, it may, however, attempt an uplink TBF establishment in an other cell after successful cell reselection. The mobile station may attempt to enter the dedicated mode in the same cell before timer T3172 has expired. During the time T3172 is running, the mobile station shall ignore all received PACKET PAGING REQUEST messages except paging request to trigger RR connection establishment;
- If both the mobile station and the network support multiple TBF procedures the mobile station shall start one instance of timer T3172 for each uplink TBF that was rejected. All TBFs in progress that are not rejected shall be maintained. The mobile station is not allowed to attempt re-establishment of a rejected uplink TBF in the same cell until its associated instance of timer T3172 expires. It may, however, attempt re-establishment of a rejected uplink TBF in another cell after successful cell reselection. The mobile station may attempt to enter the dedicated mode in the same cell before all instances of timer T3172 have expired. During the time one or more instances of T3172 are running, the mobile station shall ignore all received PACKET PAGING REQUEST messages except paging request to trigger RR connection establishment.

The value of the WAIT\_INDICATION field (i.e. timer T3172) relates to the cell from which it was received.

#### 8.1.1.1.2.1 Abnormal cases

The following abnormal cases apply:

- If the mobile station receives an uplink assignment message (e.g. PACKET UPLINK ASSIGNMENT, MULTIPLE TBF UPLINK ASSIGNMENT, PACKET TIMESLOT RECONFIGURE, MULTIPLE TBF TIMESLOT RECONFIGURE or PACKET CS RELEASE INDICATION message) and detects an invalid Frequency Parameters information element in the message, the mobile station shall perform an abnormal release with system information (see sub-clause 8.7.3), performing a partial acquisition of system information messages containing frequency information;
- If the mobile station receives an uplink assignment message (e.g. PACKET UPLINK ASSIGNMENT, MULTIPLE TBF UPLINK ASSIGNMENT, PACKET TIMESLOT RECONFIGURE, MULTIPLE TBF TIMESLOT RECONFIGURE or PACKET CS RELEASE INDICATION message) specifying frequencies that are not all in one frequency band then the mobile station shall perform an abnormal release with access retry (see sub-clause 8.7.2);
- If the information in the PACKET UPLINK ASSIGNMENT or the MULTIPLE TBF UPLINK ASSIGNMENT message does not properly specify an uplink PDCH or specifies a multislot configuration that the mobile station does not support (see 3GPP TS 45.002), the mobile station shall perform an abnormal release with access retry (see sub-clause 8.7.2);
- If the information in the PACKET TIMESLOT RECONFIGURE, MULTIPLE TBF TIMESLOT RECONFIGURE or PACKET CS RELEASE INDICATION message does not properly specify an uplink and

downlink PDCH or specifies a multislot configuration that the mobile station does not support (see 3GPP TS 45.002), the mobile station shall perform an abnormal release with access retry (see sub-clause 8.7.2);

- If the mobile station receives a PACKET UPLINK ASSIGNMENT or a MULTIPLE TBF UPLINK ASSIGNMENT message containing a Frequency Parameters information element specifying a frequency that is in a frequency band not supported by the mobile station then the mobile station shall perform an abnormal release with access retry (see sub-clause 8.7.2);
- If a mobile station in dual transfer mode receives a PACKET UPLINK ASSIGNMENT, MULTIPLE TBF UPLINK ASSIGNMENT, PACKET TIMESLOT RECONFIGURE or MULTIPLE TBF TIMESLOT RECONFIGURE message including frequency parameters for the carrier supporting the dedicated resources, the mobile station shall perform an abnormal release with access retry (see sub-clause 8.7.2);
- If a mobile station receives a PACKET UPLINK ASSIGNMENT, MULTIPLE TBF UPLINK ASSIGNMENT, PACKET TIMESLOT RECONFIGURE or MULTIPLE TBF TIMESLOT RECONFIGURE message indicating a change of EGPRS level which is forbidden (see sub-clause 8.1.1.7), the mobile station shall perform an abnormal release with access retry (see sub-clause 8.7.2);
- If both the mobile station and the network support multiple TBF procedures and if any given uplink assignment message provides an uplink TBF allocation for a PFI not indicated in the PACKET RESOURCE REQUEST message and not associated with any ongoing uplink TBF, the mobile station shall abort the procedure and perform an abnormal release with access retry (see sub-clause 8.7.2);
- If both the mobile station and the network support EMST or EMSR and if any given uplink assignment message provides an allocation of an RLC entity for a PFI not indicated in the PACKET RESOURCE REQUEST message and not associated with any already allocated RLC entity on the uplink TBF, the mobile station shall abort the procedure and perform an abnormal release with access retry (see sub-clause 8.7.2);
- If both the mobile station and the network support EMST and if any given uplink assignment message includes an assignment for more RLC entities than the mobile station supports or more than one RLC entity is assigned to use same RLC mode to a TBF, the mobile station shall abort the procedure and perform abnormal release with access retry (see sub-clause 8.7.2);
- If a failure in the uplink assignment message (e.g. PACKET UPLINK ASSIGNMENT, MULTIPLE TBF UPLINK ASSIGNMENT, PACKET TIMESLOT RECONFIGURE, MULTIPLE TBF TIMESLOT RECONFIGURE or PACKET CS RELEASE INDICATION message) is due to any other reason (including frequency parameters which do not comply with the requirements specified in sub-clause 5.5.1.7), the mobile station shall perform an abnormal release with access retry (see sub-clause 8.7.2).

**NOTE:** An uplink assignment message (e.g. PACKET UPLINK ASSIGNMENT, MULTIPLE TBF UPLINK ASSIGNMENT, PACKET TIMESLOT RECONFIGURE, MULTIPLE TBF TIMESLOT RECONFIGURE or PACKET CS RELEASE INDICATION message) received by a multi-band mobile station shall not be considered invalid if it indicates new frequencies that are all in a different frequency band to that of the PDCH(s) on which the assignment was received. The assignment may however be rendered invalid for some other reason.

#### 8.1.1.1.3 Establishment of Downlink TBF

During uplink transfer, the network may initiate the establishment of one or more downlink TBFs by sending a downlink assignment message (e.g. PACKET DOWNLINK ASSIGNMENT, MULTIPLE TBF DOWNLINK ASSIGNMENT, PACKET TIMESLOT RECONFIGURE, MULTIPLE TBF TIMESLOT RECONFIGURE, PACKET CS RELEASE INDICATION) to the mobile station on the PACCH. If a PACKET TIMESLOT RECONFIGURE or a PACKET DOWNLINK ASSIGNMENT message is sent, then the message shall contain the DOWNLINK\_TFI\_ASSIGNMENT field for the downlink TBF being established. If multiple TBF procedures are supported by the mobile station and the network, the network shall indicate the PFI associated with each TBF it allocates or reallocates in the downlink assignment message. The network shall not attempt to establish multiple downlink TBFs for a mobile station with only one uplink TBF unless the mobile station's radio access capabilities are known. If EMST is used, the network shall indicate the PFI associated with each RLC entity in the downlink assignment message (i.e. PACKET DOWNLINK ASSIGNMENT, PACKET TIMESLOT RECONFIGURE or PACKET CS RELEASE INDICATION). The multislot restrictions of the mobile station shall be observed.

A mobile station that supports multiple TBF procedures shall act on the downlink assignment message as follows:

- Upon reception of a PACKET DOWNLINK ASSIGNMENT message the mobile station shall release all ongoing downlink TBFs not addressed by this message and shall act on the message. All ongoing uplink TBFs shall be maintained;
- Upon reception of a PACKET TIMESLOT RECONFIGURE message the mobile station shall release all ongoing uplink and downlink TBFs not addressed by this message and shall act on the message;
- Upon reception of a MULTIPLE TBF DOWNLINK ASSIGNMENT message the mobile station shall maintain all ongoing TBFs not addressed by this message using its currently allocated TBF parameters and shall act on the message;
- Upon reception of a MULTIPLE TBF TIMESLOT RECONFIGURE message the mobile station shall release all ongoing uplink and downlink TBFs not addressed by this message and shall act on the message;
- Upon reception of a PACKET CS RELEASE INDICATION message the mobile station shall release all ongoing uplink and/or downlink TBFs not addressed by this message and shall act on the message.

A mobile allocation or reference frequency list, received as part of a downlink assignment, replaces the previous parameters and shall be used until a new assignment is received or the mobile station has released all TBFs.

If the network and mobile station both support Downlink Dual Carrier, the network may send a downlink assignment message (e.g. PACKET DOWNLINK ASSIGNMENT, MULTIPLE TBF DOWNLINK ASSIGNMENT, PACKET TIMESLOT RECONFIGURE, MULTIPLE TBF TIMESLOT RECONFIGURE or PACKET CS RELEASE INDICATION) to a mobile station assigning one or more TBFs with packet resources on two carriers (referred to as carrier 1 and carrier 2) and thereby establish a Downlink Dual Carrier configuration.

If the assignment message contains the *Assignment Info* IE indicating an assignment type other than 'Dual Carrier assignment', then the packet resources specified in this message replace any existing assignment for the addressed TBFs on the carrier identified by the Carrier ID field. In this case, if the assignment message addresses TBFs that currently have packet resources assigned on the other carrier (i.e. the carrier not identified by the Carrier ID field) then these packet resources shall be treated as follows:

- these resources are implicitly released, if the ASSIGNMENT TYPE field (carried in the *Assignment Info IE*) indicates that the assignment is an "Assignment on single carrier only";
- these resources are unchanged, if the ASSIGNMENT TYPE field indicates that the assignment is a "Modification of existing assignment".

If the assignment message contains the *Assignment Info* IE indicating an assignment type of 'Dual Carrier assignment', then the packet resources specified in this message replace any existing assignment for the addressed TBFs.

If the network and mobile station both support Downlink Multi Carrier, the network may send a downlink assignment message (PACKET DOWNLINK ASSIGNMENT, PACKET TIMESLOT RECONFIGURE) to a mobile station assigning a downlink TBF with packet resources on multiple downlink carriers and thereby establish a DLMC configuration. In this case a mobile station is assigned a set of one or more UFPSs (see 3GPP TS 45.008 [15]) that in total provide up to 16 carriers. The carriers assigned to a given UFPS shall belong to the same frequency band and Mobile Allocation. If the MS has indicated it supports inter-band reception (see 3GPP TS 24.008) the set of provided carriers shall belong to a maximum of two of the supported frequency bands. The set of UFPS in a DLMC configuration are numbered UFPS<sub>1</sub>, UFPS<sub>2</sub>, and so on, ending with UFPS<sub>M</sub> where UFPS numbering is managed as follows:

- If an assignment message is sent to a mobile station with an ongoing downlink TBF for which only a single carrier is assigned then that carrier shall be considered as UFPS<sub>1</sub> for the case where the assignment message establishes a DLMC configuration information.
- An assignment message that assigns one or more new UFPS results in each new UFPS being numbered according to the order in which it was assigned. For example, if UFPS<sub>1</sub> and UFPS<sub>2</sub> are currently assigned and two new UFPS are added then the first new UFPS becomes UFPS<sub>3</sub> and the second new UFPS becomes UFPS<sub>4</sub>.
- An assignment message that deletes one or more existing UFPS results in the remaining UFPS being renumbered to ensure sequential UFPS numbering. For example, if UFPS<sub>1</sub>, UFPS<sub>2</sub> ... UFPS<sub>5</sub> are currently assigned and UFPS<sub>3</sub> is deleted then UFPS<sub>4</sub> becomes UFPS<sub>3</sub> and UFPS<sub>5</sub> becomes UFPS<sub>4</sub>.

The carriers associated with a DLMC configuration are numbered in ascending order beginning with C<sub>1</sub>, followed by C<sub>2</sub>, and so on, ending with C<sub>N</sub> where the carriers are sequentially numbered beginning with those in UFPS<sub>1</sub>, followed by

those in UFPS<sub>2</sub> and so on, ending with those in UFPS<sub>M</sub>. The ordering of carriers within a given UFPS reflects the order in which they have been assigned for that UFPS (i.e. C<sub>1</sub> is first carrier assigned for UFPS<sub>1</sub>).

If PDCH-pairs are assigned for a DLMC configuration they are numbered in ascending order starting with the lowest numbered PDCH-pair on C<sub>1</sub> and ending with the highest numbered PDCH-pair on C<sub>N</sub>:

- The RTTI\_DOWNLINK\_PDCH\_PAIR\_ASSIGNMENT\_DLMC bitmap indicates which of the PDCH pairs available on a given downlink carrier (indicated by the DOWNLINK\_PDCH\_PAIRS\_DLMC bitmap) are assigned for DLMC configuration.
- The PDCH pairs identified by the UPLINK\_PDCH\_PAIRS\_DLMC bitmap (if any) indicate the PDCH-pairs assigned for the uplink carrier corresponding to a given downlink carrier assigned for a DLMC configuration.
- When downlink PDCH pairs are assigned they are numbered in ascending order starting with the first PDCH-pair (PDCH-pair 1) consisting of the two lowest numbered timeslots assigned on C<sub>1</sub>, followed by the PDCH-pair consisting of the next two lowest numbered timeslots assigned on C<sub>1</sub> (PDCH-pair 2), and so on for the remaining timeslot pairs assigned on C<sub>1</sub> and for the assigned timeslot pairs on C<sub>2</sub>... C<sub>N</sub>.
- The highest numbered PDCH-pair consists of the two highest numbered timeslots on carrier C<sub>N</sub>.

A mobile station in a DLMC configuration may receive subsequent assignment messages (PACKET DOWNLINK ASSIGNMENT, PACKET UPLINK ASSIGNMENT or PACKET TIMESLOT RECONFIGURE) as follows:

- A PACKET UPLINK ASSIGNMENT message may be used to assign packet resources on one or more of the uplink carriers corresponding to the assigned downlink carriers (see sub-clause 8.1.1.2.1) for the case where the ongoing downlink TBF does not need to be modified.
- A PACKET DOWNLINK ASSIGNMENT message may be used for the case where there is either no uplink TBF or the ongoing uplink TBF does not need to be modified. For the case of an ongoing uplink TBF, this message is only used if all carriers on which USF is currently monitored remain assigned.
- Otherwise, the PACKET TIMESLOT RECONFIGURE message is used.

On receipt of a downlink assignment message, and after the TBF starting time, if present, the mobile station shall switch to the assigned PDCHs, and start timer T3190 for each of the TBFs assigned. The operation of the downlink TBFs follows the procedures in sub-clause 8.1.2 and 3GPP TS 44.160 with the following additions:

- the mobile station shall prioritise transmission of RLC/MAC control blocks associated with a downlink TBF over RLC/MAC control blocks associated with an uplink TBF;
- if a timer or counter expiry causes an uplink TBF to be aborted in the mobile station, the mobile station shall perform an abnormal release with access retry as specified in sub-clause 8.7.2 (*A/Gb mode*) or 3GPP TS 44.160 (*Iu mode*);
- If one uplink and one downlink TBF are already established, then the network may send a PACKET TIMESLOT RECONFIGURE message without DOWNLINK\_TFI\_ASSIGNMENT or, for a DLMC configuration, without DOWNLINK\_eTFI\_ASSIGNMENT. The mobile station shall interpret this as a reassignment of the timeslot allocations of the concurrent uplink and downlink TBFs and the downlink TFI is not changed.

#### 8.1.1.1.3.1 Abnormal cases

If a failure occurs on the mobile station side before the new TBF(s) has been successfully established, the newly reserved resources are released. The subsequent behaviour of the mobile station depends on the type of failure and previous actions:

- If the information in the PACKET TIMESLOT RECONFIGURE or MULTIPLE TBF TIMESLOT RECONFIGURE message does not properly specify an uplink and downlink PDCH or specifies a multislot configuration that the mobile station does not support (see 3GPP TS 45.002), the mobile station shall perform an abnormal release with access retry (see sub-clause 8.7.2 and 3GPP TS 44.160);
- If one uplink and one downlink TBF are not already established and the PACKET TIMESLOT RECONFIGURE message does not include a DOWNLINK\_TFI\_ASSIGNMENT field, then the mobile station shall perform an abnormal release with access retry (see sub-clause 8.7.2 and 3GPP TS 44.160);

- If a mobile station in dual transfer mode or MAC-DTM state receives a downlink assignment message (e.g. PACKET DOWNLINK ASSIGNMENT, MULTIPLE TBF DOWNLINK ASSIGNMENT, PACKET TIMESLOT RECONFIGURE, MULTIPLE TBF TIMESLOT RECONFIGURE or PACKET CS RELEASE INDICATION message) including frequency parameters for the carrier supporting the dedicated resources, the mobile station shall perform an abnormal release with access retry (see sub-clause 8.7.2 and 3GPP TS 44.160);
- If a failure in the PACKET TIMESLOT RECONFIGURE or MULTIPLE TBF TIMESLOT RECONFIGURE message is due to any other reason, the mobile station shall abort the procedure and perform an abnormal release with access retry (see sub-clause 8.7.2 and 3GPP TS 44.160);
- If both the mobile station and the network support multiple TBF procedures and if any given downlink assignment message provides an uplink TBF allocation for a PFI not associated with any ongoing uplink TBF, the mobile station shall abort the procedure and perform an abnormal release with access retry (see sub-clause 8.7.2 and 3GPP TS 44.160);
- If a mobile station that does not support Downlink Dual Carrier receives a PACKET DOWNLINK ASSIGNMENT message, PACKET TIMESLOT RECONFIGURE message, MULTIPLE TBF DOWNLINK ASSIGNMENT message or a MULTIPLE TBF TIMESLOT RECONFIGURE message that assigns resources on more than one carrier or includes the *Assignment Info* IE which indicates that the assignment is a 'Modification of an existing assignment' or a 'Dual Carrier assignment', the mobile station shall perform an abnormal release with access retry (see sub-clause 8.7.2 and 3GPP TS 44.160);
- If a mobile which supports Downlink Dual Carrier receives a PACKET DOWNLINK ASSIGNMENT message, PACKET TIMESLOT RECONFIGURE message, MULTIPLE TBF DOWNLINK ASSIGNMENT message or a MULTIPLE TBF TIMESLOT RECONFIGURE message that assigns resources on two carriers and those two carriers are not within the same frequency band, the mobile station shall perform an abnormal release with access retry (see sub-clause 8.7.2 and 3GPP TS 44.160);
- If a mobile station that supports Downlink Multi Carrier receives a PACKET DOWNLINK ASSIGNMENT message or PACKET TIMESLOT RECONFIGURE message that establishes or modifies a DLMC configuration wherein resources are assigned on carriers in different frequency bands but does not support inter-band reception, the mobile station shall perform an abnormal release with access retry (see sub-clause 8.7.2);
- If a mobile station that supports Downlink Multi Carrier receives a PACKET DOWNLINK ASSIGNMENT message or PACKET TIMESLOT RECONFIGURE message that establishes or modifies a DLMC configuration with more carriers or more downlink timeslots than it supports, or assigns eTFIs or a SNS of 8192 or CS-3 for PDAN coding when the mobile station supports 20 or fewer time slots, or assigns carriers in a frequency band it does not support, the mobile station shall perform an abnormal release with access retry (see sub-clause 8.7.2);
- If a mobile station that supports Downlink Multi Carrier receives a PACKET DOWNLINK ASSIGNMENT message that modifies a DLMC configuration that releases carriers on which USF is being monitored, the mobile station shall perform an abnormal release with access retry (see sub-clause 8.7.2);
- If a mobile station that supports Downlink Multi Carrier receives a PACKET DOWNLINK ASSIGNMENT message or PACKET TIMESLOT RECONFIGURE message that assigns two or more UFPSs to the same Mobile Allocation (as defined by the *DLMC Frequency Parameter* IE), the mobile station shall perform an abnormal release with access retry (see sub-clause 8.7.2);
- If a mobile station that supports Downlink Multi Carrier receives a PACKET UPLINK ASSIGNMENT message that modifies a DLMC configuration by assigning an uplink carrier that does not correspond to an existing downlink carrier, the mobile station shall perform an abnormal release with access retry (see sub-clause 8.7.2);
- If a failure in the PACKET DOWNLINK ASSIGNMENT, MULTIPLE TBF DOWNLINK ASSIGNMENT or PACKET CS RELEASE INDICATION message is due to any other reason (including the presence of frequency parameters which do not comply with the requirements specified in sub-clause 5.5.1.7), the mobile station shall abort the procedure and continue the normal operation of the ongoing uplink TBFs and ongoing downlink TBFs.

### 8.1.1.2 Extended Dynamic Allocation uplink RLC data block transfer

The Extended Dynamic Allocation medium access method extends the Dynamic Allocation medium access method to allow higher uplink throughput.

This sub-clause defines the extensions to the Dynamic Allocation medium access method. All procedures defined in sub-clause 8.1.1.1 apply, except where this sub-clause defines a new procedure. In cases where this sub-clause conflicts with sub-clause 8.1.1.1, this sub-clause takes precedence.

#### 8.1.1.2.1 Uplink PDCH Allocation

The PACKET UPLINK ASSIGNMENT and MULTIPLE TBF UPLINK ASSIGNMENT messages assign to the mobile station a subset of 1 to N uplink PDCHs (when the uplink TBF operates in BTTI configuration) or uplink PDCH-pairs (when the uplink TBF operates in RTTI configuration), where N depends on the mobile station multislot class.

An uplink TBF that operates in RTTI configuration may receive the assigned USFs either in BTTI USF mode or in RTTI USF mode. The indication of whether BTTI USF mode or RTTI USF mode is to be used is provided during the assignment of the corresponding uplink TBF.

If a mobile station supports Downlink Dual Carrier, the PACKET UPLINK ASSIGNMENT or MULTIPLE TBF UPLINK ASSIGNMENT message may assign PDCHs (corresponding to any given uplink TBF) on more than one carrier frequency. If this occurs, the Extended Dynamic Allocation procedures shall operate independently on each of the two carriers.

A mobile station with a DL MC configuration shall only act on a PACKET UPLINK ASSIGNMENT message if it includes the *DL MC UL Carrier Info* IE (see sub-clause 11.2.29). In this case the message may reference one or more of the uplink carriers corresponding to the set of downlink carriers and indicate the following:

- The referenced uplink carrier is not part of the uplink TBF in which case all resources for that uplink carrier (if any) are released.
- The referenced uplink carrier is part of the uplink TBF. If the message assigns no resources for that carrier then its existing resources remain unchanged. Otherwise, the assigned resources shall replace the existing resources (if any) for that carrier.
- If the message does not reference an uplink carrier then all resources for that uplink carrier (if any) are released.

A mobile station that has an uplink TBF operating in BTTI configuration shall monitor the downlink PDCHs corresponding to (i.e. with the same timeslot number as) its assigned uplink PDCHs starting with the lowest numbered PDCH, then the next lowest numbered PDCH, etc., up to the one corresponding to the highest numbered assigned uplink PDCH except if the mobile station is in DTR mode. A mobile station in DTR mode shall only monitor the timeslot indicated in the DTR information (see sub-clause 8.1.8). A mobile station that has an uplink TBF operating in RTTI configuration shall monitor the downlink PDCH-pairs starting with the one corresponding to the uplink PDCH-pair with the lowest numbered timeslots, then the next uplink PDCH-pair, etc., up to the downlink PDCH-pair corresponding to the uplink PDCH-pair with the highest numbered timeslots assigned to the mobile station except if the mobile station is in DTR mode. A mobile station in DTR mode shall only monitor the downlink PDCH-pair indicated in the DTR information (see sub-clause 8.1.8). When in dual transfer mode, the network shall not assign uplink PDCHs whose corresponding downlink PDCH cannot be monitored by the mobile station because of the presence of the uplink dedicated channel. As an exception, in the case of dual transfer mode, if the mobile station indicates support of DTM high multislot class capability, the network may also assign uplink PDCHs whose corresponding downlink PDCH cannot be monitored by the mobile station. In this case, the mobile station shall monitor only those downlink PDCHs that are feasible when taking into account the position of the uplink dedicated channel and the switching requirements of its multislot class (see 3GPP TS 45.002).

Whenever a mobile station with an uplink TBF operating in BTTI configuration detects an assigned USF value on a monitored PDCH, the mobile station shall transmit either a single RLC/MAC block or a sequence of four RLC/MAC blocks on the corresponding uplink PDCH (i.e. with the same timeslot number as the downlink PDCH on which the USF was detected) and on all higher numbered assigned uplink PDCHs except if it is in DTR mode. A mobile station in DTR mode shall perform any necessary uplink transmissions upon the detection of its assigned USF(s) using Dynamic Allocation procedures as specified in sub-clause 8.1.1.1.

The following applies for an uplink TBF in RTTI configuration that receives USFs in BTTI USF mode:

- An assigned USF received on the first PDCH of a monitored downlink PDCH-pair allocates resources for one or four uplink RTTI radio blocks in the first two TDMA frames of the following basic radio block period(s) on the corresponding uplink PDCH-pair and all assigned uplink PDCH-pairs with higher numbered timeslots.

- An assigned USF received on the second PDCH of a monitored downlink PDCH-pair allocates resources for one or four uplink RTTI radio blocks in the second two TDMA frames of the following basic radio block period(s) on the corresponding uplink PDCH-pair and all assigned uplink PDCH-pairs with higher numbered timeslots.

The following applies for an uplink TBF in RTTI configuration that receives USFs in RTTI USF mode:

- An assigned USF received in the first reduced radio block period of a given basic radio block period on a monitored downlink PDCH-pair allocates resources for one or four uplink RTTI radio blocks in the second reduced radio block period starting in the same basic radio block period and continuing with the second reduced radio block period in the following basic radio block periods, depending on the USF granularity, on the corresponding uplink PDCH-pair and all assigned uplink PDCH-pairs with higher numbered timeslots.
- An assigned USF received in the second reduced radio block period of a given basic radio block period on a monitored downlink PDCH-pair allocates resources for one or four uplink RTTI radio blocks in the first reduced radio block period starting in the next basic radio block period and continuing with the first reduced radio block period in the following basic radio block periods, depending on the USF granularity, on the corresponding uplink PDCH-pair and all assigned uplink PDCH-pairs with higher numbered timeslots.

The following applies for an uplink TBF operating in an MTTI configuration when BTTI USF mode is used (i.e. RTTI\_USF\_MODE is set to '0'):

- An assigned USF received on the first or second PDCH of a monitored downlink PDCH-pair allocates resources as specified above for the case of an uplink TBF in RTTI configuration where USFs are received in BTTI USF mode. In addition, if, within the MTTI configuration, the uplink BTTI resource uses a higher numbered timeslot number than the RTTI resources, an assigned USF received on the first PDCH of a monitored downlink PDCH-pair (i.e. a PDCH-pair that corresponds to an uplink PDCH-pair that is part of the uplink MTTI configuration) allocates resources for one or four uplink BTTI radio blocks using the BTTI resources within the MTTI configuration.
- An assigned USF received on the downlink PDCH that corresponds to the uplink BTTI PDCH resource allocates resources for one or four uplink BTTI radio blocks using the BTTI resources within the MTTI configuration and, if the uplink RTTI resources use higher numbered timeslots than the uplink BTTI resource, two or eight uplink RTTI radio blocks (i.e. in both the first and second reduced radio block periods in the subsequent basic radio block period(s)) for each assigned RTTI PDCH-pair within the MTTI configuration.

NOTE: Examples of allocations of MTTI resources are given in Annex M.

The following applies for an uplink TBF operating in an MTTI configuration when RTTI USF mode is used (i.e. RTTI\_USF\_MODE is set to '1'):

- An assigned USF received in RTTI USF mode (i.e. on a downlink PDCH-pair corresponding to an assigned uplink PDCH-pair) allocates resources only for the assigned uplink RTTI resources, in accordance with the specifications for RTTI-only assignments. RTTI USFs do not allocate the uplink BTTI PDCH within an MTTI configuration.
- An assigned USF received on the downlink PDCH corresponding to the uplink BTTI PDCH resource allocates resources for one or four uplink BTTI radio blocks using the BTTI resources within the MTTI configuration. In addition, if, within the MTTI configuration, the uplink BTTI resource uses a lower numbered timeslot number than the RTTI resources, then an assigned USF received on the downlink PDCH corresponding to the uplink BTTI PDCH resource allocates resources for two or eight uplink RTTI radio blocks (i.e. in both the first and second reduced radio block periods in the subsequent basic radio block period(s)) for each assigned RTTI PDCH-pair within the MTTI configuration.

For a mobile station with an uplink TBF for which EFTA is used transmissions shall be performed on the uplink PDCHs or PDCH-pairs allocated by the USF as specified in Annex N. In case the mobile station also has one or more concurrent downlink TBF(s), but does not have enough RLC/MAC blocks ready for transmission to fully utilize the total number of allocated resources for uplink radio block transmission during the corresponding radio block period(s), then it shall immediately begin monitoring its assigned downlink PDCHs or PDCH-pairs after transmitting its last available RLC/MAC block taking into account the switching time requirements of its multislot class (see 3GPP TS 45.002).

The time relation between an uplink block which the mobile station shall use for transmission and the occurrence of the USF value is defined in 3GPP TS 45.002. The number of RLC/MAC blocks to transmit on each allocated uplink PDCH/PDCH-pair is controlled by the USF\_GRANULARITY parameter characterising the uplink TBF. The mobile



station shall, in either BTTI or RTTI configuration, ignore the USF on those higher numbered PDCHs or PDCH-pairs with higher numbered timeslots during the block period where the assigned USF value is detected. In addition, if USF\_GRANULARITY is set to four blocks allocation, it may ignore the USF on all other PDCHs/PDCH-pairs during the first three block periods in which the mobile station has been granted permission to transmit. As specified in 3GPP TS 45.002, the USF corresponding to the last three blocks of a four blocks allocation shall be set to an unused value for each PDCH/PDCH-pair on which the mobile station has been granted permission to transmit.

The mobile station shall, during a basic or reduced radio block period in which it has been granted permission to transmit, monitor the assigned USF on the downlink PDCHs/PDCH-pairs corresponding to its assigned uplink PDCHs/PDCH-pairs starting with the lowest numbered PDCH or PDCH-pair with the lowest numbered timeslots up to the highest numbered PDCH or PDCH-pair with the highest numbered timeslots which the mobile is able to monitor, taking into account the PDCHs/PDCH-pairs allocated for transmission in the basic or reduced radio block period and the switching requirements of the mobile station multislot class (see 3GPP TS 45.002). A mobile station in DTR mode shall only monitor the assigned USF on the downlink PDCH/PDCH-pair indicated in DTR information (see sub-clause 8.1.8).

If the network wishes to reduce the number of PDCHs/PDCH-pairs allocated to a mobile station per basic/reduced radio block period, the network may do so, provided that this is compatible with the mobile station's ability to monitor the assigned USF in the downlink PDCH/PDCH-pairs corresponding to the lowest numbered uplink PDCH or PDCH-pair with the lowest numbered timeslots in the new allocation. Otherwise, the network shall not allocate any resources to that mobile station for one basic/reduced radio block period following the basic/reduced radio block period with the higher number of PDCHs/PDCH-pairs allocated.

During the downlink block period where an uplink basic/reduced TTI radio block is allocated on a PDCH/PDCH-pair via the polling mechanism (see sub-clause 10.4.4), the mobile station shall monitor the assigned USF on the downlink PDCHs/PDCH-pairs corresponding to its assigned uplink PDCHs/PDCH-pairs starting with the lowest numbered PDCH or PDCH-pair with the lowest numbered timeslots up to the highest numbered PDCH or PDCH-pair with the highest numbered timeslots which is feasible when taking into account the PDCHs/PDCH-pairs allocated for transmission in the basic/reduced radio block period and the switching requirements of the mobile station multislot class (see 3GPP TS 45.002).

#### 8.1.1.2.2 PACCH operation

The mobile station shall attempt to decode every downlink RLC/MAC block on the downlink PDCH corresponding to (i.e. with the same timeslot number as) the lowest numbered timeslot in the PDCH assignment when the uplink TBF operates in the BTTI configuration. A mobile station operating in DTR mode (see sub-clause 8.1.8) shall attempt to decode every RLC/MAC block on a downlink PDCH which the mobile station is required to monitor for the assigned USF as indicated in the DTR information as specified in sub-clause 8.1.1.2.1.

In case the uplink TBF operates in RTTI configuration the mobile station shall attempt to decode every downlink RLC/MAC block on the corresponding downlink PDCH-pair associated with the lowest numbered assigned uplink PDCH-pair (i.e. with lowest time slot numbers) in the set of assigned uplink PDCH-pairs (i.e. downlink PACCH blocks are received in the same mode as the assigned uplink TBF). A mobile station operating in DTR mode (see sub-clause 8.1.8) shall attempt to decode every RLC/MAC block on a downlink PDCH-pair which the mobile station is required to monitor for the assigned USF as indicated in the DTR information as specified in sub-clause 8.1.1.2.1.

Whenever the mobile station receives an RLC/MAC block containing an RLC/MAC control block, the mobile station shall attempt to interpret the message contained therein. If the message addresses the mobile station, the mobile station shall act on the message.

In case the uplink TBF operates in BTTI configuration then the network shall transmit all PACCH messages on the PDCH carried on the downlink timeslot corresponding to the lowest numbered timeslot in the assignment. Additionally for the concurrent TBF case, the network may transmit PACCH messages on any of the common timeslots assigned to the downlink and uplink PDCH assignment.

In case the uplink TBF operates in RTTI configuration then the network shall transmit all PACCH messages on the corresponding downlink PDCH-pair associated with the lowest numbered assigned uplink PDCH-pair. Additionally, for the concurrent TBF case, the network may transmit PACCH messages on any of the PDCH-pairs assigned that are common to the downlink and uplink PDCH-pair assignments.

In case the uplink TBF operates in MTTI configuration, then the network shall transmit all PACCH messages on the PDCH or PDCH-pair that uses the lowest numbered timeslot in the MTTI configuration. Additionally, for the case of

concurrent uplink and downlink TBFs, the network may transmit PACCH messages on any PDCH or PDCH-pair which is common to the uplink and downlink resource assignments.

Whenever a mobile station, that has an assigned uplink TBF that operates in BTTI configuration, detects an assigned USF value on any monitored PDCH, the mobile station may transmit a PACCH block on the same PDCH in the next block period. Whenever a mobile station, that has an assigned uplink TBF that operates in RTTI configuration, detects an assigned USF value on any corresponding downlink PDCH-pair associated with an assigned uplink PDCH-pair, the mobile station may transmit a PACCH block on the PDCH-pair. The PACCH block shall be transmitted according to the USF scheduling in 8.1.1.2.1. The mobile station shall not transmit an RLC data block in any uplink radio block allocated via the polling mechanism (see sub-clauses 10.4.4, 10.4.4a, 10.4.4b) unless the uplink TBF operates in either RTTI configuration, or in BTTI configuration with FANR activated, and the mobile station is polled for a Piggy-backed Ack/Nack (see sub-clause 10.4.4b).

In the case of a Downlink Dual Carrier configuration or a DLMC configuration, all segments belonging to each RLC/MAC control message shall be sent on PACCH blocks belonging to the same carrier.

When a mobile station in a DLMC configuration supporting more than 20 downlink timeslots sends an EGPRS Packet Downlink Ack/Nack DLMC message (see sub-clause 11.2.48) it shall be coded using CS-1 or CS-3 as indicated by the most recently received assignment message. Otherwise, if it supports 20 or less downlink timeslots, EGPRS Packet Downlink Ack/Nack DLMC messages shall be coded using CS-1.

#### 8.1.1.2.3 Neighbour cell power measurements

The mobile station shall perform neighbour cell measurements during any unused PDCH or group of unused PDCHs where the MS's Measurement Capabilities indicate that the mobile station is capable of making a neighbour cell measurement.

The network shall ensure that there are sufficient gaps as to allow the necessary number of measurements based upon the MS's Measurement Capabilities.

#### 8.1.1.2.4 Shifted USF operation

In some instances (see 3GPP TS 45.002), Shifted USF operation shall apply.

When Shifted USF operation is used, the USF for the first assigned uplink PDCH shall be sent on the downlink PDCH corresponding to (i.e. with the same timeslot number as) the second assigned uplink PDCH. The MS shall monitor this downlink PDCH for the USF corresponding to both the first assigned uplink PDCH and the second assigned uplink PDCH. If the USF corresponding to the first assigned uplink PDCH is detected then operation shall be as described in sub-clause 8.1.1.2.1. for the case where the assigned USF was received on the downlink PDCH corresponding to the first assigned uplink PDCH. Otherwise, operation shall be as described in sub-clause 8.1.1.2.1.

The USF value corresponding to the first assigned uplink PDCH shall be different from the USF value corresponding to the second assigned uplink PDCH.

When Shifted USF operation is used, PACCH operation shall be as described in sub-clause 8.1.1.2.2 except that the network shall transmit all PACCH messages on the PDCH carried on the downlink timeslot corresponding to the second lowest numbered timeslot in the uplink assignment, and the mobile station shall attempt to decode every downlink RLC/MAC block on that downlink PDCH.

If a PACKET PDCH RELEASE message releases the second uplink PDCH in the current timeslot configuration of a mobile station using Shifted USF operation then the first uplink timeslot shall also be considered released. If any PDCHs remain in the new timeslot configuration then normal USF operation shall continue starting on the lowest available timeslot.

### 8.1.1.3 (void)

### 8.1.1.3a Exclusive allocation RLC data block transfer

#### 8.1.1.3a.1 General

This sub-clause specifies mobile station behaviour for *exclusive allocation* of radio resources for uplink RLC data block transfer. The exclusive allocation is applicable only in dual transfer mode (for half-rate PDCHs only) and MAC-DTM state (for half-rate PDCHs only). The conditions for using exclusive allocation are specified in sub-clause 8.1.0.

When the mobile station receives an uplink assignment (e.g. PACKET UPLINK ASSIGNMENT, MULTIPLE TBF UPLINK ASSIGNMENT, PACKET TIMESLOT RECONFIGURE or MULTIPLE TBF TIMESLOT RECONFIGURE) that does not contain a TBF starting time, the mobile station shall switch to the assigned PDCHs and be ready to transmit within the reaction time defined in 3GPP TS 45.010. If a TBF starting time is present, the mobile station shall wait until the starting time before it switches to the assigned PDCHs and starts to transmit. If a TBF starting time is present and an uplink TBF or one or more downlink TBFs are already in progress, the mobile station shall continue to use the previously assigned resources for the uplink TBF until the TBF starting time occurs. If the mobile station receives another uplink assignment, while waiting for the TBF starting time, the mobile station shall act upon the most recently received uplink assignment and shall ignore the previous one.

When mobile station has received the uplink assignment and been granted the right to transmit using exclusive allocation, the mobile station shall start timer T3184 and transmit an RLC/MAC block in every uplink radio block on the PDCHs assigned for the TBF. The timer T3184 shall be restarted every time the mobile station receives a PACKET UPLINK ACK/NACK message.

The timer T3184 shall be stopped at the release of the TBF. The timer T3184 shall also be stopped if the resources for the TBF are reallocated, such that the conditions for exclusive allocation are no longer fulfilled and the TBF continues using dynamic or extended dynamic allocation (see sub-clause 8.1.0).

A mobile station supporting multiple TBF procedures and operating in DTM mode with exclusive allocation may only establish a single uplink TBF. However, one or more downlink TBFs may still be established when exclusive allocation is used for the uplink TBF. In this case the network may allocate the radio resources for the uplink TBF by sending the mobile station one of the following messages:

- A PACKET UPLINK ASSIGNMENT message if there is no more than one concurrent downlink TBF;
- A MULTIPLE TBF UPLINK ASSIGNMENT message if there are multiple concurrent downlink TBFs;
- A PACKET TIMESLOT RECONFIGURE message if there is one concurrent downlink TBF that is also being reallocated;
- A MULTIPLE TIMESLOT RECONFIGURE message if there are multiple concurrent downlink TBFs and at least one of them is being reallocated or there are multiple concurrent downlink TBFs and resources for at least one new downlink TBF are being allocated.

#### 8.1.1.3a.2 Radio link failure

If timer T3184 expires (see sub-clause 8.1.1.3a.1), the mobile station shall regard that as a radio link failure and perform an abnormal release with access retry (see sub-clause 8.7.2 and 3GPP TS 44.160).

The network shall increment counter N3101 for each radio block allocated to the TBF for which no RLC/MAC block is received. Whenever the network receives an RLC/MAC block from the mobile station, it shall reset counter N3101 for that TBF. If N3101 reaches the value N3101max, the network shall stop sending PACKET UPLINK ACK/NACK messages to the mobile station for that TBF and shall start timer T3169 for the TBF. If an RLC/MAC block is received from the TBF when timer T3169 is running, the network shall stop timer T3169 and resume sending PACKET UPLINK ACK/NACK messages to the TBF. When T3169 expires, the network may consider the TBF as released and reuse the TFI value(s). If PS Handover is ongoing, it is optional for the network to increment N3101.

### 8.1.1.3a.3 (void)

### 8.1.1.3a.4 PACCH operation

The mobile station shall attempt to decode every downlink RLC/MAC block on the PDCH with the lowest timeslot number assigned for an uplink TBF operating in BTTI configuration and shall attempt to decode every downlink RLC/MAC block on the PDCH-pair with the lowest timeslot numbers assigned for an uplink TBF operating in RTTI configuration. Whenever the mobile station receives an RLC/MAC block containing an RLC/MAC control block, the mobile station shall attempt to interpret the message contained therein. If the message is a distribution message or a non-distribution message that addresses the mobile station, the mobile station shall act on the message.

During the transmission on the uplink TBF, the mobile station may use any uplink RLC/MAC block, assigned for the uplink TBF, for the transmission of an RLC/MAC control block (PACCH). The mobile station shall not transmit an RLC data block in any uplink RLC/MAC block allocated to the mobile station via the polling mechanism (see sub-clause 10.4.4).

### 8.1.1.3a.5 Resource Reallocation for Uplink

#### 8.1.1.3a.5.1 General

The reallocation of radio resources may take place during an uplink TBF, due to a change of service demand from the mobile station, or due to reasons determined by the network. This procedure shall not be used to change neither the RLC mode nor the TBF mode of the uplink TBF. A change of RLC mode or TBF mode shall be achieved through the release of the uplink TBF and establishment of a new TBF.

#### 8.1.1.3a.5.2 Change of service demand

During an uplink packet transfer, upper layers may request the transfer an upper layer PDU with a different PFI, a different radio priority, a different peak throughput class or a different RLC mode than the one, which is in transfer. In case of an upper layer PDU containing signalling information, it shall be transferred with the highest radio priority and requesting acknowledged RLC mode.

If upper layers request the transfer of another upper layer PDU with a different PFI, a different Radio Priority, a different peak throughput class or a different RLC mode than the one which is in transfer, then the procedures as described in packet transfer mode (see sub-clause 8.1.1.2) shall be applied by the mobile station.

If the mobile station, at the change of service demand, has started the countdown procedure (see sub-clause 9.3.1) in order to release the uplink TBF, the mobile station shall perform the release of the uplink TBF as normal. The mobile station may then establish a new uplink TBF, according to the new service demand.

If the countdown procedure has not been started or the TBF is operated in the extended uplink TBF mode (see sub-clause 9.3.1b) and the new upper layer PDU shall be transferred with the same RLC mode as the current uplink TBF, the mobile station shall indicate a change of service demand to the network by sending a PACKET RESOURCE REQUEST message on PACCH.

When the PACKET RESOURCE REQUEST message is sent, the mobile station shall start timer T3168.

If the new upper layer PDU shall be transmitted with a different RLC mode than the current uplink TBF, the mobile station may complete the transmission of the preceding upper layer PDUs and shall then release the TBF and establish a new uplink TBF for transmission of the new upper layer PDU. If the TBF is operated in extended TBF mode (see sub-clause 9.3.1b), the mobile station shall use the procedure in sub-clause 8.1.1.6 for changing the RLC mode.

After the transmission of the PACKET RESOURCE REQUEST message, the mobile station shall continue to use the currently assigned uplink TBF, assuming that the network grants the requested service demand.

On receipt of the PACKET RESOURCE REQUEST message the network shall respond by either the reallocation of radio resources for an uplink TBF (sub-clause 8.1.1.3a.5.3) or the rejection of service demand (sub-clause 8.1.1.3a.5.4).

The mobile station shall stop timer T3168 at the receipt of a PACKET UPLINK ASSIGNMENT, a MULTIPLE TBF UPLINK ASSIGNMENT, PACKET TIMESLOT RECONFIGURE or a MULTIPLE TBF TIMESLOT RECONFIGURE message, or when the mobile station has completed its currently assigned TBFs. If timer T3168 expires, the mobile station shall retransmit the PACKET RESOURCE REQUEST message and again start timer T3168.

#### 8.1.1.3a.5.3 Reallocation of radio resources for an uplink TBF

The network may reallocate the radio resources for an uplink TBF by sending the mobile station a PACKET UPLINK ASSIGNMENT or a PACKET CS RELEASE INDICATION message if there is no more than one concurrent downlink TBF or a MULTIPLE TBF UPLINK ASSIGNMENT or a PACKET CS RELEASE INDICATION message if there are multiple concurrent downlink TBFs. If there is a concurrent downlink TBF and the radio resources for the downlink TBF are also affected, the network shall use a PACKET TIMESLOT RECONFIGURE or a PACKET CS RELEASE INDICATION message for the reallocation. If there are multiple concurrent downlink TBFs and the radio resources for at least one downlink TBF are also affected, the network shall use a MULTIPLE TBF TIMESLOT RECONFIGURE or a PACKET CS RELEASE INDICATION message for the reallocation.

On receipt of the PACKET UPLINK ASSIGNMENT, the MULTIPLE TBF UPLINK ASSIGNMENT, the PACKET TIMESLOT RECONFIGURE, MULTIPLE TBF TIMESLOT RECONFIGURE or the PACKET CS RELEASE INDICATION message, the mobile station shall treat the message as an uplink assignment, as defined in sub-clause 8.1.1.1.2. On receipt of the PACKET TIMESLOT RECONFIGURE, MULTIPLE TBF TIMESLOT RECONFIGURE or the PACKET CS RELEASE INDICATION message, the mobile station shall, in addition, treat the message as a downlink assignment, as defined in sub-clause 8.1.2.1.

#### 8.1.1.3a.5.4 Rejection of new service demand

On the receipt of a PACKET RESOURCE REQUEST message from the mobile station indicating a change of service demand, the network may reject the service demand by sending a PACKET ACCESS REJECT message to the mobile station.

On receipt of the PACKET ACCESS REJECT message, the mobile station shall stop timer T3168 if running, abort the uplink TBF and indicate a packet access failure to upper layers. If no downlink TBF exists, the mobile station in dual transfer mode shall return to dedicated mode. The DRX mode procedures shall be applied, as specified in sub-clause 5.5.1.5.

The PACKET ACCESS REJECT message may contain a wait indication (i.e. the WAIT\_INDICATION field) in the Reject structure addressed to the mobile station. In that case, the mobile station shall start timer T3172 with the indicated value. The mobile station shall not attempt to establish a new uplink TBF in the same cell while timer T3172 is running. If a successful cell reselection is performed, the mobile station shall stop timer T3172 and may establish an uplink TBF in the new cell.

While timer T3172 is running, the mobile station shall ignore any PACKET PAGING REQUEST message that may be received, except paging requests to trigger RR connection establishment and paging request including MBMS notification.

#### 8.1.1.3a.5.5 Abnormal cases

The following abnormal cases apply:

- If timer T3168 expires and the PACKET RESOURCE REQUEST message has already been transmitted four times, the mobile station shall perform an abnormal release with access retry (see sub-clause 8.7.2 and 3GPP TS 44.160);
- If the mobile station receives an uplink assignment (e.g. PACKET UPLINK ASSIGNMENT, MULTIPLE TBF UPLINK ASSIGNMENT, PACKET TIMESLOT RECONFIGURE, MULTIPLE TBF TIMESLOT RECONFIGURE or PACKET CS RELEASE INDICATION message) including frequency parameters for the carrier supporting the dedicated resources, the mobile station shall perform an abnormal release with access retry (see sub-clause 8.7.2 and 3GPP TS 44.160);
- If a failure in the uplink assignment (e.g. PACKET UPLINK ASSIGNMENT, MULTIPLE TBF UPLINK ASSIGNMENT, PACKET TIMESLOT RECONFIGURE, MULTIPLE TBF TIMESLOT RECONFIGURE or PACKET CS RELEASE INDICATION message) is due to any other reason, the mobile station shall perform an abnormal release with access retry (see sub-clause 8.7.2 and 3GPP TS 44.160).

### 8.1.1.3a.6 Establishment of Downlink TBF

#### 8.1.1.3a.6.1 General

During an uplink TBF using exclusive allocation, the network may initiate the establishment of one or more downlink TBFs by sending a downlink assignment message (e.g. PACKET DOWNLINK ASSIGNMENT, MULTIPLE TBF DOWNLINK ASSIGNMENT, PACKET TIMESLOT RECONFIGURE or MULTIPLE TBF TIMESLOT RECONFIGURE message) to the mobile station on the PACCH. If multiple TBF procedures are not supported the PACKET TIMESLOT RECONFIGURE message shall be used if the timeslot allocation for the on-going uplink TBF needs to be changed. If the mobile station and network support multiple TBF procedures the PACKET DOWNLINK ASSIGNMENT, MULTIPLE TBF DOWNLINK ASSIGNMENT, PACKET TIMESLOT RECONFIGURE and MULTIPLE TBF TIMESLOT RECONFIGURE messages shall be used as described in sub-clause 8.1.1.1.3.

On receipt of the downlink assignment message (e.g. PACKET DOWNLINK ASSIGNMENT, MULTIPLE TBF DOWNLINK ASSIGNMENT, PACKET TIMESLOT RECONFIGURE, MULTIPLE TBF TIMESLOT RECONFIGURE or PACKET CS RELEASE INDICATION message) the mobile station shall switch to the assigned PDCHs. If the assignment message includes a TBF starting time, the mobile station shall first wait until the indicated starting time and then switch to the assigned PDCHs. If the assigning message does not include a TBF starting time, or the TBF starting time has already passed when the assigning message is received, the mobile station shall switch to the assigned PDCHs within the reaction time specified in 3GPP TS 45.010.

When the mobile station switches to the assigned PDCHs, it starts timer T3190 for each downlink TBF assigned. The operation of the downlink TBFs then follows the procedures defined in sub-clause 8.1.2 and 3GPP TS 44.160, with the following additions:

- The mobile station shall prioritise transmission of RLC/MAC control blocks associated with a downlink TBF over RLC/MAC control blocks associated with the uplink TBF;
- If a timer or counter expiry causes the uplink TBF to be aborted in the mobile station, the mobile station shall perform an abnormal release according to the procedure defined for the uplink TBF, which may cause also the downlink TBF to be aborted;
- If one uplink and one downlink TBF are established, the network may send a PACKET TIMESLOT RECONFIGURE or PACKET CS RELEASE INDICATION message without the UPLINK\_TFI\_ASSIGNMENT field. The mobile station shall interpret this as a reassignment of the concurrent uplink and downlink TBFs. The TFI of the uplink TBF is not changed.

#### 8.1.1.3a.6.2 Abnormal cases

If a failure occurs on the mobile station side before the downlink TBF has been successfully established, the newly reserved resources are released. The subsequent behaviour of the mobile station depends on the type of failure and previous actions:

- If the information in the PACKET TIMESLOT RECONFIGURE, MULTIPLE TBF TIMESLOT RECONFIGURE or PACKET CS RELEASE INDICATION message does not properly specify an uplink and downlink PDCH or specifies a multislot configuration that the mobile station does not support (see 3GPP TS 45.002), the mobile station shall perform an abnormal release with access retry (see sub-clause 8.7.2 and 3GPP TS 44.160);
- If a downlink TBF is not already established and the PACKET TIMESLOT RECONFIGURE message does not include a DOWNLINK\_TFI\_ASSIGNMENT field, then the mobile station shall perform an abnormal release with access retry (see sub-clause 8.7.2 and 3GPP TS 44.160);
- If a mobile station in dual transfer mode receives a PACKET DOWNLINK ASSIGNMENT, MULTIPLE TBF DOWNLINK ASSIGNMENT, PACKET TIMESLOT RECONFIGURE or MULTIPLE TBF TIMESLOT RECONFIGURE message including frequency parameters for the carrier supporting the dedicated resources, the mobile station shall perform an abnormal release with access retry (see sub-clause 8.7.2 and 3GPP TS 44.160);
- If a failure in the PACKET TIMESLOT RECONFIGURE, MULTIPLE TBF TIMESLOT RECONFIGURE or PACKET CS RELEASE INDICATION message is due to any other reason, the mobile station shall abort the procedure and perform an abnormal release with access retry (see sub-clause 8.7.2 and 3GPP TS 44.160);

- If a failure in the PACKET DOWNLINK ASSIGNMENT, MULTIPLE TBF DOWNLINK ASSIGNMENT message is due to any other reason, the mobile station shall abort the procedure and continue the normal operation of the ongoing uplink and downlink TBFs.

#### 8.1.1.4 Network initiated release of uplink TBF

The network may initiate release of an uplink TBF by transmitting a PACKET TBF RELEASE message to the mobile station on the PACCH. A cause value indicates the reason for release.

If the cause value is "Normal release" the mobile station shall continue to the next upper layer PDU boundary, starting the count down procedure (see sub-clause 9.3.1) at whatever value of CV is appropriate to count down to zero at the upper layer PDU boundary, and then release the uplink TBF according to the procedures in sub-clause 9.3.2.3 or 9.3.3.3. If multiple TBF procedures are not supported and the mobile station has more upper layer PDU(s) to send, the mobile station may initiate the establishment of a new uplink TBF as defined in sub-clause 7.1, 8.1.1 and 3GPP TS 44.160. If the mobile station and network support multiple TBF procedures the mobile station may initiate the establishment of one or more new uplink TBFs as defined in sub-clause 8.1.1 and 8.1.1.2. If the uplink TBF is using EMST, the mobile station shall release the uplink TBF by releasing each RLC entity allocated to this TBF as specified in sub-clause 9.3.2.3 or 9.3.3.3.

If the cause value is "Abnormal Release", the mobile station shall abort the uplink TBF and perform an abnormal release with access retry (see sub-clause 8.7.2 and 3GPP TS 44.160). If a valid RRBP field is received as part of the PACKET TBF RELEASE message, the mobile station shall transmit a PACKET CONTROL ACKNOWLEDGEMENT message in the uplink radio block specified.

#### 8.1.1.5 Abnormal cases

The following abnormal cases apply:

- if the mobile station receives a PACKET UPLINK ASSIGNMENT, MULTIPLE TBF UPLINK ASSIGNMENT, PACKET TIMESLOT RECONFIGURE, MULTIPLE TBF TIMESLOT RECONFIGURE, PACKET DOWNLINK ASSIGNMENT, MULTIPLE TBF DOWNLINK ASSIGNMENT or PACKET CS RELEASE INDICATION message with an invalid Frequency Parameters information element, the mobile station shall perform an abnormal release with system information (see sub-clause 8.7.3), performing a partial acquisition of system information messages containing frequency information;
- if the mobile station receives a PACKET UPLINK ASSIGNMENT, MULTIPLE TBF UPLINK ASSIGNMENT, PACKET TIMESLOT RECONFIGURE, MULTIPLE TBF TIMESLOT RECONFIGURE, PACKET DOWNLINK ASSIGNMENT, MULTIPLE TBF DOWNLINK ASSIGNMENT or PACKET CS RELEASE INDICATION message specifying frequencies that are not all in one band then the mobile shall perform an abnormal release with access retry (see sub-clause 8.7.2 and 3GPP TS 44.160);
- if a mobile station in dual transfer mode receives a PACKET UPLINK ASSIGNMENT, MULTIPLE TBF UPLINK ASSIGNMENT, PACKET DOWNLINK ASSIGNMENT, MULTIPLE TBF DOWNLINK ASSIGNMENT, PACKET TIMESLOT RECONFIGURE or a MULTIPLE TBF TIMESLOT RECONFIGURE message including frequency parameters for the carrier supporting the dedicated resources, the mobile station shall perform an abnormal release with access retry (see sub-clause 8.7.2 and 3GPP TS 44.160);
- if the mobile station receives a PACKET UPLINK ACK/NACK message with missing mandatory fields, the MS shall perform an abnormal release with access retry (see sub-clause 8.7.2 and 3GPP TS 44.160);
- if the mobile station is operating in the non-extended uplink TBF mode (see sub-clause 9.3.1b) and the mobile station has not started, or has started but not completed the countdown procedure for a given TBF and it receives a PACKET UPLINK ACK/NACK message with the Final Ack Indicator set for that TBF, it shall perform an abnormal release with access retry (see sub-clause 8.7.2 and 3GPP TS 44.160).

NOTE: A PACKET UPLINK ASSIGNMENT, MULTIPLE TBF UPLINK ASSIGNMENT, PACKET TIMESLOT RECONFIGURE, MULTIPLE TBF TIMESLOT RECONFIGURE, PACKET DOWNLINK ASSIGNMENT, MULTIPLE TBF DOWNLINK ASSIGNMENT or PACKET CS RELEASE INDICATION message sent to a multi-band mobile station shall not be considered invalid if it indicates new frequencies that are all in a different frequency band to that of the ARFCN of the serving cell.

### 8.1.1.6 Change of RLC mode in extended uplink TBF mode

#### 8.1.1.6.1 General

This procedure applies to a mobile station having an uplink TBF in extended uplink TBF mode. The procedure shall be used to release the ongoing uplink TBF and to setup a new TBF in another RLC mode.

#### 8.1.1.6.2 Change of RLC mode

The mobile station shall send a PACKET RESOURCE REQUEST message on PACCH indicating the new RLC mode and start timer T3168.

If timer T3168 expires, the mobile station shall retransmit the PACKET RESOURCE REQUEST message and restart timer T3168.

On receipt of a PACKET RESOURCE REQUEST message, indicating a change of RLC mode, the network shall release the uplink TBF at a point determined by the network, using the procedure defined in sub-clause 9.5.

On receipt of PACKET UPLINK ACK/NACK with Final Ack Indicator set to '1' the mobile station shall stop timer T3168 and after sending the PACKET CONTROL ACKNOWLEDGEMENT message perform the change of RLC mode by establishing a new TBF.

#### 8.1.1.6.3 Abnormal cases

The following abnormal cases apply:

- If timer T3168 expires and the PACKET RESOURCE REQUEST message has already been transmitted four times, the mobile station shall perform an abnormal release with access retry (see sub-clause 8.7.2).

### 8.1.1.7 Change of EGPRS level

#### 8.1.1.7.1 Change of EGPRS level for downlink TBFs

The network may indicate to the mobile station that the EGPRS level applicable to a downlink TBF shall be changed. The mobile station shall not consider any transition (to or from any EGPRS level) to be an error, provided that the mobile station supports the new EGPRS level in the downlink.

#### 8.1.1.7.2 Change of EGPRS level for uplink TBFs

The network may indicate to the mobile station that the EGPRS level applicable to an uplink TBF shall be changed. The transitions which can be performed are shown in table 8.1.1.7.2.1.

**Table 8.1.1.7.2.1: Permitted EGPRS level changes**

Current EGPRS level	New EGPRS Level
EGPRS	EGPRS2-A
EGPRS	EGPRS2-B
EGPRS2-B	EGPRS
EGPRS2-A	EGPRS

Transitions not listed in Table 8.1.1.7.2.1 are not permitted.

The modulation and coding scheme to be used for retransmissions in case of a transition from EGPRS to EGPRS2-A (respectively EGPRS2-B) is shown in Table 8.1.1.7.2.2 (respectively Table 8.1.1.7.2.3) below.



**Table 8.1.1.7.2.2: Choice of modulation and coding scheme for retransmissions (initial transmission EGPRS, level changed to EGPRS2-A)**

Scheme used for Initial transmission	Scheme to use for retransmissions after switching to EGPRS2-A (MCS or UAS)				
	UAS-11 Commanded	UAS-10 Commanded	UAS-9 Commanded	UAS-8 Commanded	UAS-7 Commanded
MCS-9	UAS-9	UAS-9	UAS-9	MCS-6	MCS-6
MCS-8	MCS-6 (NOTE 2)				
MCS-7	UAS-10	UAS-10	UAS-7	UAS-7	UAS-7
MCS-6	UAS-9	UAS-9	UAS-9	MCS-6	MCS-6
MCS-5	UAS-10	UAS-10	UAS-7	UAS-7	UAS-7
MCS-4	MCS-4	MCS-4	MCS-4	MCS-4	MCS-4
MCS-3	MCS-3	MCS-3	MCS-3	MCS-3	MCS-3
MCS-2	MCS-2	MCS-2	MCS-2	MCS-2	MCS-2
MCS-1	MCS-1	MCS-1	MCS-1	MCS-1	MCS-1

NOTE 1: If MCS-1 to MCS-6 is commanded, see Table 8.1.1.1 or Table 8.1.1.2 as appropriate.  
 NOTE 2: In this case, 6 octets of padding are used.

**Table 8.1.1.7.2.3: Choice of modulation and coding scheme for retransmissions (initial transmission EGPRS, level changed to EGPRS2-B) with re-segmentation**

Scheme used for Initial transmission	Scheme to use for retransmissions after switching to EGPRS2-B (MCS or UBS)							
	UBS-12 Commanded	UBS-11 Commanded	UBS-10 Commanded	UBS-9 Commanded	UBS-8 Commanded	UBS-7 Commanded	UBS-6 Commanded	UBS-5 Commanded
MCS-9	UBS-12	UBS-10	UBS-10	UBS-8	UBS-8	UBS-6	UBS-6	UBS-6
MCS-8	UBS-11	UBS-11	UBS-10	UBS-8	UBS-8	UBS-6	UBS-6	UBS-6
MCS-7	UBS-9	UBS-9	UBS-9	UBS-9	UBS-7	UBS-7	UBS-5	UBS-5
MCS-6	UBS-12	UBS-10	UBS-10	UBS-8	UBS-8	UBS-6	UBS-6	UBS-6
MCS-5	UBS-9	UBS-9	UBS-9	UBS-9	UBS-7	UBS-7	UBS-5	UBS-5
MCS-4	MCS-4	MCS-4	MCS-4	MCS-4	MCS-4	MCS-4	MCS-4	MCS-4
MCS-3	MCS-3	MCS-3	MCS-3	MCS-3	MCS-3	MCS-3	MCS-3	MCS-3
MCS-2	MCS-2	MCS-2	MCS-2	MCS-2	MCS-2	MCS-2	MCS-2	MCS-2
MCS-1	MCS-1	MCS-1	MCS-1	MCS-1	MCS-1	MCS-1	MCS-1	MCS-1

NOTE 1: If MCS-1 to MCS-4 is commanded, see Table 8.1.1.1.

**Table 8.1.1.7.2.4a: Choice of modulation and coding scheme for retransmissions (initial transmission EGPRS, level changed to EGPRS2-B) without re-segmentation**

Scheme used for Initial transmission	Scheme to use for retransmissions after switching to EGPRS2-B (MCS or UBS)							
	UBS-12 Commanded	UBS-11 Commanded	UBS-10 Commanded	UBS-9 Commanded	UBS-8 Commanded	UBS-7 Commanded	UBS-6 Commanded	UBS-5 Commanded
MCS-9	UBS-12	UBS-10	UBS-10	UBS-8	UBS-8	UBS-6	UBS-6	UBS-6
MCS-8	UBS-11	UBS-11	UBS-10	UBS-8	UBS-8	UBS-6	UBS-6	UBS-6
MCS-7	UBS-9	UBS-9	UBS-9	UBS-9	UBS-7	UBS-7	UBS-5	UBS-5
MCS-6	UBS-12	UBS-10	UBS-10	UBS-8	UBS-8	UBS-6	UBS-6	UBS-6
MCS-5	UBS-9	UBS-9	UBS-9	UBS-9	UBS-7	UBS-7	UBS-5	UBS-5
MCS-4	MCS-4	MCS-4	MCS-4	MCS-4	MCS-4	MCS-4	MCS-4	MCS-4
MCS-3	MCS-3	MCS-3	MCS-3	MCS-3	MCS-3	MCS-3	MCS-3	MCS-3
MCS-2	MCS-2	MCS-2	MCS-2	MCS-2	MCS-2	MCS-2	MCS-2	MCS-2
MCS-1	MCS-1	MCS-1	MCS-1	MCS-1	MCS-1	MCS-1	MCS-1	MCS-1

**Table 8.1.1.7.2.4b: Choice of modulation and coding scheme for retransmissions (initial transmission EGPRS, level changed to EGPRS2-B) without re-segmentation**

Scheme used for Initial transmission	Scheme to use for retransmissions after switching to EGPRS2-B (MCS or UBS)			
	MCS-4 Commanded	MCS-3 Commanded	MCS-2 Commanded	MCS-1 Commanded
MCS-9	UBS-6	UBS-6	UBS-6	UBS-6
MCS-8	UBS-6	UBS-6	UBS-6	UBS-6
MCS-7	UBS-5	UBS-5	UBS-5	UBS-5
MCS-6	UBS-6	UBS-6	UBS-6	UBS-6
MCS-5	UBS-5	UBS-5	UBS-5	UBS-5
MCS-4	MCS-4	MCS-4	MCS-4	MCS-4
MCS-3	MCS-3	MCS-3	MCS-3	MCS-3
MCS-2	MCS-2	MCS-2	MCS-2	MCS-2
MCS-1	MCS-1	MCS-1	MCS-1	MCS-1

The modulation and coding scheme to be used for retransmissions in case of a transition from EGPRS2-A (respectively EGPRS2-B) to EGPRS is shown in Tables 8.1.1.7.2.5 and 8.1.1.7.2.6 (respectively Tables 8.1.1.7.2.7 and 8.1.1.7.2.8) below.

**Table 8.1.1.7.2.5: Choice of modulation and coding scheme for retransmissions (initial transmission EGPRS2-A, level changed to EGPRS) with re-segmentation**

Scheme used for Initial transmission	Scheme to use for retransmissions after switching to EGPRS (MCS)						
	MCS-9 Commanded	MCS-8 Commanded	MCS-7 Commanded	MCS-6-9 Commanded	MCS-6 Commanded	MCS-5-7 Commanded	MCS-5 Commanded
UAS-11	MCS-6 (NOTE 2)	MCS-6 (NOTE 2)	MCS-6 (NOTE 2)	MCS-6 (NOTE 2)	MCS-6 (NOTE 2)	MCS-3 (NOTE 2)	MCS-3 (NOTE 2)
UAS-10	MCS-7	MCS-7	MCS-7	MCS-5	MCS-5	MCS-7	MCS-5
UAS-9	MCS-9	MCS-6	MCS-6	MCS-9	MCS-6	MCS-3	MCS-3
UAS-8	MCS-6 (NOTE 2)	MCS-6 (NOTE 2)	MCS-6 (NOTE 2)	MCS-6 (NOTE 2)	MCS-6 (NOTE 2)	MCS-3 (NOTE 2)	MCS-3 (NOTE 2)
UAS-7	MCS-7	MCS-7	MCS-7	MCS-5	MCS-5	MCS-7	MCS-5
MCS-6	MCS-9	MCS-6	MCS-6	MCS-9	MCS-6	MCS-3	MCS-3
MCS-5	MCS-7	MCS-7	MCS-7	MCS-5	MCS-5	MCS-7	MCS-5
MCS-4	MCS-4	MCS-4	MCS-4	MCS-4	MCS-4	MCS-4	MCS-4
MCS-3	MCS-3	MCS-3	MCS-3	MCS-3	MCS-3	MCS-3	MCS-3
MCS-2	MCS-2	MCS-2	MCS-2	MCS-2	MCS-2	MCS-2	MCS-2
MCS-1	MCS-1	MCS-1	MCS-1	MCS-1	MCS-1	MCS-1	MCS-1

NOTE 1: If MCS-1 to MCS-4 is commanded, see Table 8.1.1.3.  
 NOTE 2: In this case, 10 octets of padding are used.

**Table 8.1.1.7.2.6: Choice of modulation and coding scheme for retransmissions (initial transmission EGPRS2-A, level changed to EGPRS) without re-segmentation**

Scheme used for Initial transmission	Scheme to use for retransmissions after switching to EGPRS (MCS)						
	MCS-9 Commanded	MCS-8 Commanded	MCS-7 Commanded	MCS-6-9 Commanded	MCS-6 Commanded	MCS-5-7 Commanded	MCS-5 Commanded

UAS-11	MCS-6 (NOTE 2)	MCS-6 (NOTE 2)	MCS-6 (NOTE 2)	MCS-6 (NOTE 2)	MCS-6 (NOTE 2)	MCS-6 (NOTE 2)	MCS-6 (NOTE 2)
UAS-10	MCS-7	MCS-7	MCS-7	MCS-5	MCS-5	MCS-7	MCS-5
UAS-9	MCS-9	MCS-6	MCS-6	MCS-9	MCS-6	MCS-6	MCS-6
UAS-8	MCS-6 (NOTE 2)	MCS-6 (NOTE 2)	MCS-6 (NOTE 2)	MCS-6 (NOTE 2)	MCS-6 (NOTE 2)	MCS-6 (NOTE 2)	MCS-6 (NOTE 2)
UAS-7	MCS-7	MCS-7	MCS-7	MCS-5	MCS-5	MCS-7	MCS-5
MCS-6	MCS-9	MCS-6	MCS-6	MCS-9	MCS-6	MCS-6	MCS-6
MCS-5	MCS-7	MCS-7	MCS-7	MCS-5	MCS-5	MCS-7	MCS-5
MCS-4	MCS-4	MCS-4	MCS-4	MCS-4	MCS-4	MCS-4	MCS-4
MCS-3	MCS-3	MCS-3	MCS-3	MCS-3	MCS-3	MCS-3	MCS-3
MCS-2	MCS-2	MCS-2	MCS-2	MCS-2	MCS-2	MCS-2	MCS-2
MCS-1	MCS-1	MCS-1	MCS-1	MCS-1	MCS-1	MCS-1	MCS-1

NOTE 1: If MCS-1 to MCS-4 is commanded, see Table 8.1.1.4.  
NOTE 2: In this case, 10 octets of padding are used.

**Table 8.1.1.7.2.7: Choice of modulation and coding scheme for retransmissions (initial transmission EGPRS2-B, level changed to EGPRS) with re-segmentation**

Scheme used for Initial transmission	Scheme to use for retransmissions after switching to EGPRS (MCS)						
	MCS-9 Commanded	MCS-8 Commanded	MCS-7 Commanded	MCS-6-9 Commanded	MCS-6 Commanded	MCS-5-7 Commanded	MCS-5 Commanded
UBS-12	MCS-9	MCS-6	MCS-6	MCS-9	MCS-6	MCS-3	MCS-3
UBS-11	MCS-8	MCS-8	MCS-6	MCS-6	MCS-6	MCS-3	MCS-3
UBS-10	MCS-8 / MCS-9 (NOTE 2)	MCS-8 / MCS-6 (NOTE 2)	MCS-6	MCS-9	MCS-6	MCS-3	MCS-3
UBS-9	MCS-7	MCS-7	MCS-7	MCS-5	MCS-5	MCS-7	MCS-5
UBS-8	MCS-8 / MCS-9 (NOTE 2)	MCS-8 / MCS-6 (NOTE 2)	MCS-6	MCS-9	MCS-6	MCS-3	MCS-3
UBS-7	MCS-7	MCS-7	MCS-7	MCS-5	MCS-5	MCS-7	MCS-5
UBS-6	MCS-8 / MCS-9 (NOTE 2)	MCS-8 / MCS-6 (NOTE 2)	MCS-6	MCS-6	MCS-6	MCS-3	MCS-3
UBS-5	MCS-7	MCS-7	MCS-7	MCS-5	MCS-5	MCS-7	MCS-5
MCS-4	MCS-4	MCS-4	MCS-4	MCS-4	MCS-4	MCS-4	MCS-4
MCS-3	MCS-3	MCS-3	MCS-3	MCS-3	MCS-3	MCS-3	MCS-3
MCS-2	MCS-2	MCS-2	MCS-2	MCS-2	MCS-2	MCS-2	MCS-2
MCS-1	MCS-1	MCS-1	MCS-1	MCS-1	MCS-1	MCS-1	MCS-1

NOTE 1: If MCS-1 to MCS-4 is commanded, see Table 8.1.1.5.  
NOTE 2: If the last transmission was with padding, then MCS-8 is used; otherwise, the alternative coding scheme specified above is used.

**Table 8.1.1.7.2.8: Choice of modulation and coding scheme for retransmissions (initial transmission EGPRS2-B, level changed to EGPRS) without re-segmentation**

Scheme used for Initial transmission	Scheme to use for retransmissions after switching to EGPRS (MCS)						
	MCS-9 or MCS-8 or MCS-7 or MCS-6-9 or MCS-6 Commanded	MCS-5-7 Commanded	MCS-5 Commanded	MCS-4 Commanded	MCS-3 Commanded	MCS-2 Commanded	MCS-1 Commanded

UBS-12	MCSs defined in Table 8.1.1.7.2.7	MCS-6	MCS-6	MCS-6	MCS-6	MCS-6	MCS-6
UBS-11	MCSs defined in Table 8.1.1.7.2.7	MCS-6	MCS-6	MCS-6	MCS-6	MCS-6	MCS-6
UBS-10	MCSs defined in Table 8.1.1.7.2.7	MCS-6	MCS-6	MCS-6	MCS-6	MCS-6	MCS-6
UBS-9	MCSs defined in Table 8.1.1.7.2.7	MCS-7	MCS-5	MCS-5	MCS-5	MCS-5	MCS-5
UBS-8	MCSs defined in Table 8.1.1.7.2.7	MCS-6	MCS-6	MCS-6	MCS-6	MCS-6	MCS-6
UBS-7	MCSs defined in Table 8.1.1.7.2.7	MCS-7	MCS-5	MCS-5	MCS-5	MCS-5	MCS-5
UBS-6	MCSs defined in Table 8.1.1.7.2.7	MCS-6	MCS-6	MCS-6	MCS-6	MCS-6	MCS-6
UBS-5	MCSs defined in Table 8.1.1.7.2.7	MCS-7	MCS-5	MCS-5	MCS-5	MCS-5	MCS-5
MCS-4	MCSs defined in Table 8.1.1.7.2.7	MCS-4	MCS-4	MCS-4	MCS-4	MCS-4	MCS-4
MCS-3	MCSs defined in Table 8.1.1.7.2.7	MCS-3	MCS-3	MCS-3	MCS-3	MCS-3	MCS-3
MCS-2	MCSs defined in Table 8.1.1.7.2.7	MCS-2	MCS-2	MCS-2	MCS-2	MCS-2	MCS-2
MCS-1	MCSs defined in Table 8.1.1.7.2.7	MCS-1	MCS-1	MCS-1	MCS-1	MCS-1	MCS-1

## 8.1.2 Downlink RLC data block transfer

For a TBF in BTTI configuration, prior to the initiation of RLC data block transfer on the downlink, the network assigns the following parameters in a downlink assignment (e.g. PACKET DOWNLINK ASSIGNMENT, MULTIPLE TBF DOWNLINK ASSIGNMENT, PACKET TIMESLOT RECONFIGURE, MULTIPLE TBF TIMESLOT RECONFIGURE or PACKET CS RELEASE INDICATION) message:

- a Temporary Flow Identity (TFI). The TFI applies to all radio blocks transferred in regards to:
  - the downlink Temporary Block Flow (TBF) ,
  - or in case EMST is used, to the RLC entity allocated on the downlink TBF,
  - or in case EMSR is enabled for an RLC entity, to each PFC supported by that RLC entity on the downlink TBF;
  - or for a DLMC configuration, to a downlink carrier assigned to the downlink TBF where different TFIs may be assigned for each carrier of the TBF;
- an eTFI, optionally assigned in case of a downlink TBF assigned to a MS supporting eTFI (see sub-clause 5.13);
- a set of PDCHs to be used for the downlink transfer;
- optionally, a TBF starting time indication (not applicable for dual carrier, multi carrier, BTTI with FANR activated, and EGPRS2 configurations);
- a PFI associated with each allocated TBF if the network and the mobile station both support multiple TBF procedures. In case EMST is supported by the network and the mobile station, the PFI associated with each allocated RLC entity. In case EMSR is enabled for one or more RLC entities of the allocated TBF, the assignment message indicates the PFI associated with each PFC supported by these RLC entities.

In case RTTI configuration is supported by the network and the mobile station and a downlink TBF operating in RTTI configuration is assigned, the following parameters shall be provided by the network in the assignment message (e.g. PACKET DOWNLINK ASSIGNMENT, MULTIPLE TBF DOWNLINK ASSIGNMENT, PACKET TIMESLOT RECONFIGURE, MULTIPLE TBF TIMESLOT RECONFIGURE or PACKET CS RELEASE INDICATION).

- a Temporary Flow Identity (TFI). The TFI applies to all radio blocks transferred in regards to:
  - the downlink Temporary Block Flow (TBF) ,

- or in case EMST is used, to the RLC entity allocated on the downlink TBF,
- or in case EMSR is enabled for an RLC entity, to each PFC supported by that RLC entity on the downlink TBF;
- or for a DLMC configuration, to a downlink carrier assigned to the downlink TBF where different TFIs may be assigned for each carrier of the TBF;
- an eTFI, optionally assigned in case of a downlink TBF assigned to a MS supporting eTFI (see sub-clause 5.13);
- one or more downlink PDCH-pairs to be used for the downlink transfer;
- a PFI associated with each allocated TBF if the network and the mobile station both support multiple TBF procedures. In case EMST is supported by the network and the mobile station, the PFI associated with each allocated RLC entity. In case EMSR is enabled for one or more RLC entities of the allocated TBF, the assignment message indicates the PFI associated with each PFC supported by these RLC entities.

The network may, at any time during downlink packet transfer, change the TTI configuration of an already established downlink TBF by sending on the downlink PACCH a downlink TBF assignment message (e.g. PACKET DOWNLINK ASSIGNMENT, MULTIPLE TBF DOWNLINK ASSIGNMENT, PACKET TIMESLOT RECONFIGURE, MULTIPLE TBF TIMESLOT RECONFIGURE or PACKET CS RELEASE INDICATION). In case of a TTI configuration change the mobile station shall begin using the new TTI configuration within the reaction time defined in 3GPP TS 45.010.

For each TBF, the network shall prioritise RLC/MAC control blocks, not containing a PACKET DOWNLINK DUMMY CONTROL BLOCK message, to be transmitted ahead of RLC data blocks for that TBF. If the network has no other RLC/MAC block to transmit, but wishes to transmit on the downlink, the network shall transmit an RLC/MAC control block containing a PACKET DOWNLINK DUMMY CONTROL BLOCK message.

For the case where EMST is used for a downlink TBF where eTFI values have been assigned, when a corresponding PAN is sent on the uplink applicable TFI and eTFI values are those associated with the RLC entity for which the PAN is sent.

A mobile station shall only attempt to decode downlink radio blocks transmitted using a TSC it has been assigned. A mobile station that supports the extended TSC sets (see 3GPP TS 45.002 [32]) can have up to two TSCs assigned for a given PDCH and shall attempt to decode a downlink radio block it receives on that PDCH using its assigned TSC(s).

### 8.1.2.1 Downlink RLC data block transfer

A network may send an unsolicited downlink assignment message to a mobile station. A mobile station that supports multiple TBF procedures shall act on the uplink assignment message as defined in sub-clause 8.1.1.1.3.

Upon reception of a downlink assignment that does not contain a TBF starting time the mobile station shall start timer T3190 for each downlink TBF assigned in the downlink assignment message and within the reaction time defined in 3GPP TS 45.010, it shall attempt to decode every downlink block on its assigned PDCHs. If the downlink assignment message (e.g. PACKET DOWNLINK ASSIGNMENT, MULTIPLE TBF DOWNLINK ASSIGNMENT, PACKET TIMESLOT RECONFIGURE, MULTIPLE TBF TIMESLOT RECONFIGURE or PACKET CS RELEASE INDICATION message) contains a TBF starting time information element and there is no downlink TBF in progress, but one or more uplink TBFs are in progress, the mobile station shall remain on the assigned PDCHs until the TDMA frame number indicated by the TBF starting time, at which time the mobile station shall start timer T3190 for each downlink TBF assigned in the downlink assignment message and immediately begin decoding the assigned downlink PDCH(s). If the downlink assignment message (e.g. PACKET DOWNLINK ASSIGNMENT, MULTIPLE TBF DOWNLINK ASSIGNMENT, PACKET TIMESLOT RECONFIGURE, MULTIPLE TBF TIMESLOT RECONFIGURE or PACKET CS RELEASE INDICATION message) contains a TBF starting time and there are one or more downlink TBFs already in progress, the mobile station shall continue to use the parameters of the downlink TBFs in progress until the TDMA frame number indicated in the TBF starting time occurs, at which time the mobile station shall immediately begin to use the new assigned downlink TBF parameters. The mobile station shall continue to use the newly assigned parameters of each downlink TBF until the TBF is either released or reconfigured. If while waiting for the frame number indicated by the TBF starting time the mobile station receives another downlink assignment for the TBF, the mobile station shall act upon the most recently received downlink assignment and shall ignore the previous downlink assignment. Procedures on receipt of a downlink assignment message (e.g. PACKET DOWNLINK ASSIGNMENT or MULTIPLE TBF DOWNLINK ASSIGNMENT message) while no TBF is in progress are specified in sub-clause 7.2.1.1 and 3GPP TS 44.160.

Subsequent assignment messages may be sent to a mobile station operating in a Downlink Dual Carrier configuration or DLMC configuration as described in sub-clause 8.1.1.1.3.

A mobile station in DTR mode with a downlink TBF assigned shall monitor only one of the assigned PDCHs/PDCH-pairs, as specified in sub-clause 8.1.8.

If the mobile station receives a valid RLC data block addressed to one of its TBFs, the mobile station shall restart timer T3190 for that TBF. In EGPRS TBF mode T3190 is also restarted when receiving an erroneous RLC data block for which the header is correctly received and which addresses the mobile station.

If any given timer T3190 expires, the mobile station shall release that downlink TBF. If there are one or more uplink TBFs in progress, the mobile station shall perform an abnormal release with access retry (see sub-clause 8.7.2 and 3GPP TS 44.160). If any given timer T3190 expires and there are no other ongoing uplink TBFs in progress, the mobile station shall perform an abnormal release without retry (see sub-clause 8.7.1).

Upon receipt of a PACKET TBF RELEASE message referring to a downlink TBF, the mobile station shall follow the procedure in sub-clause 8.1.2.8.

#### 8.1.2.1.1 Abnormal cases

If a failure occurs on the mobile station side before one or more new TBFs have been successfully established, the newly reserved resources are released. The subsequent behaviour of the mobile station depends on the type of failure and previous actions:

- If a mobile station receives a downlink assignment message (e.g. PACKET DOWNLINK ASSIGNMENT, MULTIPLE TBF DOWNLINK ASSIGNMENT, PACKET TIMESLOT RECONFIGURE, MULTIPLE TBF TIMESLOT RECONFIGURE or PACKET CS RELEASE INDICATION message) and detects an invalid Frequency Parameters information element in the message, it shall perform an abnormal release with system information (see sub-clause 8.7.3), performing a partial acquisition of system information messages containing frequency information;
- If a mobile station in dual transfer mode receives a PACKET DOWNLINK ASSIGNMENT, a MULTIPLE TBF DOWNLINK ASSIGNMENT, a PACKET TIMESLOT RECONFIGURE or a MULTIPLE TBF TIMESLOT RECONFIGURE message including frequency parameters for the carrier supporting the dedicated resources, the mobile station shall perform an abnormal release with access retry if there is at least one ongoing uplink TBF (see sub-clause 8.7.2 and 3GPP TS 44.160), otherwise it shall perform an abnormal release without retry (see sub-clause 8.7.1 and 3GPP TS 44.160);
- If the information in the PACKET TIMESLOT RECONFIGURE, MULTIPLE TBF TIMESLOT RECONFIGURE or PACKET CS RELEASE INDICATION message does not properly specify an uplink and downlink PDCH or specifies a multislot configuration that the mobile station does not support (see 3GPP TS 45.002), the mobile station shall perform an abnormal release with access retry (see sub-clause 8.7.2 and 3GPP TS 44.160);
- If the PACKET TIMESLOT RECONFIGURE message does not include a DOWNLINK\_TFI\_ASSIGNMENT field, then the mobile station shall perform an abnormal release with access retry (see sub-clause 8.7.2 and 3GPP TS 44.160);
- If a failure in the PACKET TIMESLOT RECONFIGURE, MULTIPLE TBF TIMESLOT RECONFIGURE or PACKET CS RELEASE INDICATION message is due to any other reason, the mobile station shall abort the procedure and perform an abnormal release with access retry (see sub-clause 8.7.2 and 3GPP TS 44.160);
- If the information available in the mobile station, after the reception of a PACKET DOWNLINK ASSIGNMENT or MULTIPLE TBF DOWNLINK ASSIGNMENT message does not satisfactorily define a PDCH, the mobile station shall ignore the PACKET DOWNLINK ASSIGNMENT/MULTIPLE TBF DOWNLINK ASSIGNMENT message;
- If the mobile station does not support Downlink Dual Carrier but receives a PACKET DOWNLINK ASSIGNMENT or MULTIPLE TBF DOWNLINK ASSIGNMENT message specifying different frequency parameters than those currently in effect for the uplink TBF (see sub-clause 5.5.1.7), the mobile station shall ignore the PACKET DOWNLINK ASSIGNMENT/ MULTIPLE TBF DOWNLINK ASSIGNMENT message and continue normal operation of the uplink TBF;

- If the mobile station supports Downlink Dual Carrier, has one or more ongoing uplink TBFs and is not in a Downlink Dual Carrier configuration, but receives a PACKET DOWNLINK ASSIGNMENT or MULTIPLE TBF DOWNLINK ASSIGNMENT message specifying frequency parameters for carrier 1 that are different from those currently in effect for the uplink TBF, the mobile station shall ignore the PACKET DOWNLINK ASSIGNMENT/ MULTIPLE TBF DOWNLINK ASSIGNMENT message and continue normal operation of the uplink TBF;
- If both the mobile station and the network support multiple TBF procedures and if any given downlink assignment message provides an uplink TBF allocation for a PFI not associated with any ongoing uplink TBF, the mobile station shall abort the procedure and perform an abnormal release with access retry (see sub-clause 8.7.2 and 3GPP TS 44.160);
- If both the mobile station and the network support EMST or EMSR and if any given downlink assignment message provides an uplink resource allocation for a PFI not associated with any RLC entity allocated on the ongoing uplink TBF, the mobile station shall abort the procedure and perform an abnormal release with access retry (see sub-clause 8.7.2);
- If both the mobile station and the network support EMST and if any given uplink assignment message includes an assignment for more RLC entities than the mobile station supports or more than one RLC entity is assigned to use same RLC mode to a TBF, the mobile station shall abort the procedure and perform abnormal release with access retry (see sub-clause 8.7.2);
- If a mobile station that does not support Downlink Dual Carrier receives a downlink assignment message (e.g. PACKET DOWNLINK ASSIGNMENT, MULTIPLE TBF DOWNLINK ASSIGNMENT, PACKET TIMESLOT RECONFIGURE, MULTIPLE TBF TIMESLOT RECONFIGURE or PACKET CS RELEASE INDICATION message) that assigns resources on two carriers or includes the *Assignment Info* IE which indicates that the assignment is a 'Modification of an existing assignment' or a 'Dual Carrier assignment', the mobile station shall perform an abnormal release with access retry if there is at least one ongoing uplink TBF (see sub-clause 8.7.2 and 3GPP TS 44.160), otherwise it shall perform an abnormal release without retry (see sub-clause 8.7.1 and 3GPP TS 44.160);
- If a mobile which supports Downlink Dual Carrier receives a downlink assignment message (e.g. PACKET DOWNLINK ASSIGNMENT, MULTIPLE TBF DOWNLINK ASSIGNMENT, PACKET TIMESLOT RECONFIGURE, MULTIPLE TBF TIMESLOT RECONFIGURE or PACKET CS RELEASE INDICATION message) that assigns resources on two carriers and those two carriers are not within the same frequency band, the mobile station shall perform an abnormal release with access retry (see sub-clause 8.7.2 and 3GPP TS 44.160);
- If a mobile station that supports Downlink Multi Carrier receives a PACKET DOWNLINK ASSIGNMENT message or PACKET TIMESLOT RECONFIGURE message that establishes or modifies a DLMC configuration wherein resources are assigned on carriers in different frequency bands but does not support inter-band reception, the mobile station shall perform an abnormal release with access retry (see sub-clause 8.7.2);
- If a mobile station that supports Downlink Multi Carrier receives a PACKET DOWNLINK ASSIGNMENT message or PACKET TIMESLOT RECONFIGURE message that establishes or modifies a DLMC configuration with more carriers or more downlink timeslots than it supports, or assigns eTFIs or a SNS of 8192 or CS-3 for PDAN coding when the mobile station supports 20 or fewer time slots, or assigns carriers in a frequency band it does not support, the mobile station shall perform an abnormal release with access retry (see sub-clause 8.7.2);
- If a mobile station that supports Downlink Multi Carrier receives a PACKET DOWNLINK ASSIGNMENT message that modifies a DLMC configuration that releases carriers on which USF is being monitored, the mobile station shall perform an abnormal release with access retry (see sub-clause 8.7.2);
- If a mobile station that supports Downlink Multi Carrier receives a PACKET DOWNLINK ASSIGNMENT message or PACKET TIMESLOT RECONFIGURE message that assigns two or more UFPS to the same Mobile Allocation (as defined by the *DLMC Frequency Parameter* IE), the mobile station shall perform an abnormal release with access retry (see sub-clause 8.7.2);
- If a mobile station that supports Downlink Multi Carrier receives a PACKET UPLINK ASSIGNMENT message that modifies a DLMC configuration by assigning an uplink carrier that does not correspond to an existing downlink carrier, the mobile station shall perform an abnormal release with access retry (see sub-clause 8.7.2);
- If a failure in the PACKET DOWNLINK ASSIGNMENT or MULTIPLE TBF DOWNLINK ASSIGNMENT message is due to any other reason, the mobile station shall abort the establishment of the downlink TBFs

indicated in the downlink assignment message. If one or more ongoing uplink or downlink TBFs exist, the mobile station shall continue the normal operation of all the ongoing uplink TBFs. If no ongoing uplink or downlink TBFs exist, the mobile station shall perform an abnormal release without retry (see sub-clause 8.7.1).

### 8.1.2.2 Polling for Packet Downlink Ack/Nack

Whenever the mobile station receives an RLC data block addressed to one of its TBFs and with a valid RRB P field or with a valid CES/P field in the RLC data block header (i.e. is polled), the mobile station shall transmit one of the following replies in the uplink radio block specified by the RRB P field or CES/P field, whatever the BSN value of the received RLC data block, according to the subsequent decreasing order of priority:

- 1) a (EGPRS) PACKET DOWNLINK ACK/NACK message or EGPRS PACKET DOWNLINK ACK/NACK TYPE 2 message or EGPRS PACKET DOWNLINK ACK/NACK TYPE 3 message or EGPRS PACKET DOWNLINK ACK/NACK DLMC message containing a Final Ack Indicator;
- 2) a PACKET CS REQUEST message, if such a message is waiting to be transmitted;
- 3) a PACKET CELL CHANGE NOTIFICATION message, if such a message is waiting to be transmitted;
- 4) a (EGPRS) PACKET DOWNLINK ACK/NACK message or a EGPRS PACKET DOWNLINK ACK/NACK TYPE 2 message or a EGPRS PACKET DOWNLINK ACK/NACK DLMC message containing a Channel Request Description IE;
- 5) any other RLC/MAC control message, if such a message is waiting to be transmitted, other than a (EGPRS) PACKET DOWNLINK ACK/NACK message or EGPRS PACKET DOWNLINK ACK/NACK TYPE 2 message or EGPRS PACKET DOWNLINK ACK/NACK TYPE 3 message or EGPRS PACKET DOWNLINK ACK/NACK DLMC message;
- 6) when FANR is activated and the mobile station is polled for a PAN (see sub-clause 10.4.4b) , a PAN field corresponding to this TBF included in an EGPRS RLC/MAC block for data transfer from one of the concurrent TBFs in uplink (see sub-clause 8.1.1.);
- 7) a (EGPRS) PACKET DOWNLINK ACK/NACK message or EGPRS PACKET DOWNLINK ACK/NACK TYPE 2 message or EGPRS PACKET DOWNLINK ACK/NACK TYPE 3 message or EGPRS PACKET DOWNLINK ACK/NACK DLMC message not containing a Final Ack Indicator or a Channel Request Description IE.

However, the mobile station shall transmit an RLC/MAC control message other than a (EGPRS) PACKET DOWNLINK ACK/NACK message or EGPRS PACKET DOWNLINK ACK/NACK TYPE 2 message or EGPRS PACKET DOWNLINK ACK/NACK TYPE 3 message or EGPRS PACKET DOWNLINK ACK/NACK DLMC message at most every second time it is polled for the TBF. For a TBF with FANR activated, the mobile station may transmit an RLC/MAC control message other than a (EGPRS) PACKET DOWNLINK ACK/NACK message or EGPRS PACKET DOWNLINK ACK/NACK TYPE 2 message or EGPRS PACKET DOWNLINK ACK/NACK TYPE 3 message or EGPRS PACKET DOWNLINK ACK/NACK DLMC message only if a (EGPRS) PACKET DOWNLINK ACK/NACK message or EGPRS PACKET DOWNLINK ACK/NACK TYPE 2 message or EGPRS PACKET DOWNLINK ACK/NACK TYPE 3 message or EGPRS PACKET DOWNLINK ACK/NACK DLMC message or EGPRS RLC/MAC block for data transfer including a PAN field was transmitted as the response to the last poll.

The mobile station shall not send an EGPRS PACKET DOWNLINK ACK/NACK TYPE 3 message if not indicated as supported by the network according to the value of the *EGPRS Packet Downlink Ack/Nack Type 3 Support* field in assignment messages.

The mobile station shall not send a PACKET CONTROL ACKNOWLEDGEMENT message unless otherwise specified.

A mobile station in packet transfer mode in a Downlink Dual Carrier configuration or a DLMC configuration shall respond in the uplink radio block indicated by the RRB P field or by the CES/P field, on the same radio frequency channel as the one where the poll was received. A mobile station in dual transfer mode in a Downlink Dual Carrier configuration shall respond in the uplink radio block on the timeslot or on the PDCH pair indicated by the RRB P field or by the CES/P field, on the uplink radio frequency channel where the dedicated resource is assigned regardless of which downlink radio frequency channel the poll was received on. The network shall not poll the mobile station in a manner which would require the mobile station to respond on the same timeslot as that on which the dedicated resource is assigned.



In EGPRS TBF mode the mobile station shall react on a poll inside an erroneously received RLC data block for which the header is correctly received and which addresses the mobile station.

If EMST is used and the mobile station responds to the poll with a (EGPRS) PACKET DOWNLINK ACK/NACK message, an EGPRS PACKET DOWNLINK ACK/NACK TYPE 2 message, an EGPRS PACKET DOWNLINK ACK/NACK TYPE 3 message or an EGPRS PACKET DOWNLINK ACK/NACK DLMC message or an EGPRS RLC/MAC block for data transfer with a PAN field, then the message or the PAN field shall correspond to the RLC entity identified by the TFI in the header of the downlink RLC/MAC block containing the poll.

Whenever the network receives a valid RLC/MAC control message from a TBF, it shall reset counter N3105 for that TBF. The network shall increment counter N3105 for each radio block, allocated to that TBF with the RRB field or with the CES/P field, for which no RLC/MAC control message is received. If  $N3105 = N3105_{max}$ , the network shall release the downlink TBF internally and start timer T3195 for that TBF. When T3195 expires, the network may reuse the TFI(s).

The PACKET DOWNLINK ACK/NACK message contains a Channel Quality Report (see 3GPP TS 45.008). The optional I\_LEVEL measurement results shall be included in at least every other PACKET DOWNLINK ACK/NACK message.

The EGPRS PACKET DOWNLINK ACK/NACK message may contain an EGPRS Channel Quality Report (see 3GPP TS 45.008).

The EGPRS PACKET DOWNLINK ACK/NACK TYPE 2 message and the EGPRS PACKET DOWNLINK ACK/NACK TYPE 3 message may contain an EGPRS Channel Quality Report Type 2 (see 3GPP TS 45.008). The EGPRS PACKET DOWNLINK ACK/NACK DLMC message may contain the *DLMC Channel Quality Report* IE (see sub-clause 12.66).

In the case of simultaneous uplink and downlink TBFs, the transmission of the polling response takes precedence over the transmission of allocated uplink radio blocks.

A mobile station of multislot class 1 to 12 or multislot class 30 to 45 need not respond to the poll if it is not compliant with the multislot class of the mobile station (see 3GPP TS 45.002).

A mobile station of multislot class 13 to 18 shall always respond to the poll.

A mobile station of multislot class 19 to 29 may omit the allocated downlink PDCHs with timeslot numbers greater than  $n+1$ , while transmitting the polling response on timeslot number  $n$ . If the remaining configuration is not compliant with the multislot class of the mobile station (see 3GPP TS 45.002), the mobile station need not respond to the poll.

NOTE: The mobile station is required to make neighbour cell measurements while transmitting the polling response (see 3GPP TS 45.008).

In case of simultaneous uplink and downlink TBFs and extended dynamic allocation (see sub-clause 8.1.1.2), the network may apply polling in downlink RLC data blocks only when sent on a PDCH common for both reception and transmission (see 3GPP TS 45.002). A mobile station operating with extended dynamic allocation need to respond to polling in downlink RLC data blocks only when received on a PDCH common for both reception and transmission.

The mobile station shall not send a poll response using a TTI configuration that is different from that with which the poll was received.

### 8.1.2.3 (void)

### 8.1.2.4 Resource Reassignment for Downlink

The network initiates resource reassignment by sending a downlink assignment message (e.g. PACKET DOWNLINK ASSIGNMENT, MULTIPLE TBF DOWNLINK ASSIGNMENT, PACKET TIMESLOT RECONFIGURE, MULTIPLE TBF TIMESLOT RECONFIGURE or PACKET CS RELEASE INDICATION message) on the downlink PACCH. These messages indicate a change in resources in the same TBF. The Control Ack bit in the message shall be set to '0'. If multiple TBF procedures are supported by the mobile station and the network, the network shall indicate the PFI associated with each TBF it allocates or reallocates in the downlink assignment message. If EMST is supported by the mobile station and the network, the network shall indicate the PFI associated with each RLC entity in the downlink assignment message (i.e. PACKET DOWNLINK ASSIGNMENT, PACKET TIMESLOT RECONFIGURE or PACKET CS RELEASE INDICATION). During the reassignment of any given TBF

its associated TFI is allowed to be changed. Mobile shall use the TFI indicated in the PACKET DOWNLINK ASSIGNMENT/ MULTIPLE TBF DOWNLINK ASSIGNMENT when using the resource indicated in the message.

The network is not allowed to change the RLC mode nor TBF mode of an already established TBF during resource reallocation. Change of RLC mode or TBF mode shall be achieved through release of on-going TBF and establishment of a new TBF with the newly requested RLC mode or TBF mode using the procedures described in sub-clause 9.3.2.5 or sub-clause 9.3.3.5.

On receipt of a downlink assignment message (e.g. PACKET DOWNLINK ASSIGNMENT, MULTIPLE TBF DOWNLINK ASSIGNMENT, PACKET TIMESLOT RECONFIGURE, MULTIPLE TBF TIMESLOT RECONFIGURE or PACKET CS RELEASE INDICATION message) and after the TBF starting time, if present, the mobile station shall switch to the assigned PDCHs. Upon switching to the new PDCHs the mobile station shall restart timer T3190 for each newly assigned downlink TBF. A mobile station that supports multiple TBF procedures shall act on the uplink assignment message as defined in sub-clause 8.1.1.1.3.

When the mobile station receives an RLC/MAC block addressed to (one of) its downlink TBF(s) on any of the new assigned resources it shall restart timer T3190 for that TBF. If any given timer T3190 expires, and if one or more uplink TBF is in progress, the mobile station shall perform an abnormal release with access retry (see sub-clause 8.7.2 and 3GPP TS 44.160). If any given timer T3190 expires and there are no uplink TBFs in progress, the mobile station shall perform an abnormal release without retry (see sub-clause 8.7.1).

#### 8.1.2.4.1 Abnormal cases

These abnormal cases apply during establishment of downlink TBF after downlink TBF release (see sub-clause 9.3.2.6).

If a failure occurs on the mobile station side before the new TBF has been successfully established, the newly reserved resources are released. The subsequent behaviour of the mobile station depends on the type of failure and previous actions:

- If a mobile station receives a downlink assignment message (e.g. PACKET DOWNLINK ASSIGNMENT, MULTIPLE TBF DOWNLINK ASSIGNMENT, PACKET TIMESLOT RECONFIGURE, MULTIPLE TBF TIMESLOT RECONFIGURE or PACKET CS RELEASE INDICATION message) and detects an invalid Frequency Parameters information element in the message, the mobile station shall perform an abnormal release with system information (see sub-clause 8.7.3), performing a partial acquisition of system information messages containing frequency information;
- If a mobile station in dual transfer mode or MAC-DTM state receives a PACKET DOWNLINK ASSIGNMENT, a MULTIPLE TBF DOWNLINK ASSIGNMENT, a PACKET TIMESLOT RECONFIGURE or a MULTIPLE TBF TIMESLOT RECONFIGURE message including frequency parameters for the carrier supporting the dedicated resources, the mobile station shall perform an abnormal release with access retry if there is at least one ongoing uplink TBF (see sub-clause 8.7.2 and 3GPP TS 44.160), otherwise it shall perform an abnormal release without retry (see sub-clause 8.7.1 and 3GPP TS 44.160);
- If the information in the PACKET TIMESLOT RECONFIGURE, MULTIPLE TBF TIMESLOT RECONFIGURE or PACKET CS RELEASE INDICATION message does not properly specify an uplink and downlink PDCH or specifies a multislot configuration that the mobile station does not support (see 3GPP TS 45.002), the mobile station shall perform an abnormal release with access retry (see sub-clause 8.7.2 and 3GPP TS 44.160);
- If a failure in the PACKET TIMESLOT RECONFIGURE, MULTIPLE TBF TIMESLOT RECONFIGURE or PACKET CS RELEASE INDICATION message is due to any other reason, the mobile station shall abort the procedure and perform an abnormal release with access retry (see sub-clause 8.7.2 and 3GPP TS 44.160);
- If the information available in the mobile station, after the reception of a PACKET DOWNLINK ASSIGNMENT or MULTIPLE TBF DOWNLINK ASSIGNMENT message does not satisfactorily define a PDCH, the mobile station shall ignore the PACKET DOWNLINK ASSIGNMENT / MULTIPLE TBF DOWNLINK ASSIGNMENT message and maintain its ongoing TBFs;
- If the mobile station receives a PACKET DOWNLINK ASSIGNMENT or MULTIPLE TBF DOWNLINK ASSIGNMENT message specifying different frequency parameters than those currently in effect for its ongoing TBFs (see sub-clause 5.5.1.7), the mobile station shall ignore the PACKET DOWNLINK ASSIGNMENT message and continue normal operation of its ongoing TBFs;

- If a failure in the PACKET DOWNLINK ASSIGNMENT or MULTIPLE TBF DOWNLINK ASSIGNMENT message is due to any other reason, the mobile station shall abort the establishment of the downlink TBFs indicated in the downlink assignment message. If one or more ongoing uplink or downlink TBFs exist, the mobile station shall continue the normal operation of all ongoing uplink TBFs. If no ongoing uplink or downlink TBFs exist, the mobile station shall perform an abnormal release without retry (see sub-clause 8.7.1);
- If both the mobile station and the network support multiple TBF procedures and if any given downlink assignment message provides an uplink TBF allocation for a PFI not associated with any ongoing uplink TBF, the mobile station shall abort the procedure and perform an abnormal release with access retry (see sub-clause 8.7.2 and 3GPP TS 44.160);
- If both the mobile station and the network support EMST or EMSR and if any given downlink assignment message provides an uplink resource allocation for a PFI not associated with any RLC entity allocated on the ongoing uplink TBF, the mobile station shall abort the procedure and perform an abnormal release with access retry (see sub-clause 8.7.2);
- If both the mobile station and the network support EMST and if any given uplink assignment message includes an assignment for more RLC entities than the mobile station supports or more than one RLC entity is assigned to use same RLC mode to a TBF, the mobile station shall abort the procedure and perform abnormal release with access retry (see sub-clause 8.7.2).

### 8.1.2.5 Establishment of uplink TBF

The mobile station may request establishment of one or more uplink TBFs when there are one or more ongoing downlink TBFs by including a Channel Request Description or the Extended Channel Request Description information element in the (EGPRS) PACKET DOWNLINK ACK/NACK message or EGPRS PACKET DOWNLINK ACK/NACK TYPE 2 message, or by including a Channel Request Description information element in an EGPRS PACKET DOWNLINK ACK/NACK DLMC message. Initiation is triggered by a request from upper layers to transfer an upper layer PDU. The request from upper layers specifies a Radio Priority to be associated with the packet transfer.

When multiple TBF procedures are not supported, the mobile station initiates the packet access procedure by sending the Channel Request Description information element in the (EGPRS) PACKET DOWNLINK ACK/NACK message or EGPRS PACKET DOWNLINK ACK/NACK TYPE 2 message or EGPRS PACKET DOWNLINK ACK/NACK DLMC message on the PACCH and starting timer T3168.

When the mobile station and the network support multiple TBF procedures the mobile station may request one or more uplink TBFs by including the Extended Channel Request Description information element in the (EGPRS) PACKET DOWNLINK ACK/NACK message or EGPRS PACKET DOWNLINK ACK/NACK TYPE 2 message and starting one instance of timer T3168 for each uplink TBF it requests. Each requested uplink TBF is associated with a different PFI. A mobile station shall continue to use its ongoing downlink TBFs unless re-allocated or released as a result of the uplink assignment message(s) sent in response by the network.

If both the network and the mobile station support the extended uplink TBF mode, the request from upper layers may indicate that the new upper-layer PDU is meant to pre-allocate an uplink TBF (early TBF establishment). In this case, the EARLY\_TBF\_ESTABLISHMENT field in the (EGPRS) PACKET DOWNLINK ACK/NACK message or EGPRS PACKET DOWNLINK ACK/NACK TYPE 2 message shall indicate pre-allocation is required.

On receipt of an (Extended) Channel Request Description information element in the (EGPRS) PACKET DOWNLINK ACK/NACK message or EGPRS PACKET DOWNLINK ACK/NACK TYPE 2 message or a Channel Request Description information element in the EGPRS PACKET DOWNLINK ACK/NACK DLMC message, the network may assign radio resources to the mobile station on one or more PDCHs by transmitting an uplink assignment message (e.g. PACKET UPLINK ASSIGNMENT, MULTIPLE TBF UPLINK ASSIGNMENT, PACKET TIMESLOT RECONFIGURE or MULTIPLE TBF TIMESLOT RECONFIGURE message) on the PACCH, or may reject one or more of the requests by sending a PACKET ACCESS REJECT message on the PACCH. If the PACKET TIMESLOT RECONFIGURE message is sent, then the message shall contain the UPLINK\_TFI\_ASSIGNMENT field. If the mobile station supports RLC non-persistent mode the network may allocate one or more EGPRS TBFs that use this RLC mode.

If multiple TBF procedures are supported by the mobile station and the network, the network shall indicate the PFI associated with each TBF it allocates or reallocates in the uplink assignment message.

A mobile allocation or reference frequency list, when received in the Frequency Parameters IE, as part of an uplink assignment, replaces the previous parameters and shall be used until a new assignment is received or the mobile station has released all TBFs.

If the network and mobile station both support Downlink Dual Carrier, the network may send an uplink assignment message (e.g. PACKET UPLINK ASSIGNMENT, MULTIPLE TBF UPLINK ASSIGNMENT, PACKET TIMESLOT RECONFIGURE or MULTIPLE TBF TIMESLOT RECONFIGURE message) to a mobile station specifying one or more TBFs with packet resources on two carriers (referred to as carrier 1 and carrier 2) and thereby establish a Downlink Dual Carrier configuration. Subsequent assignment messages may be sent to a mobile station in a Downlink Dual Carrier configuration as described in sub-clause 8.1.1.1.3.

If the network and mobile station both support Downlink Multi Carrier, the network may send a PACKET TIMESLOT RECONFIGURE message to a mobile station assigning an uplink TBF and thereby establish a DLMC configuration. Subsequent assignment messages may be sent to a mobile station in a DLMC configuration as described in sub-clause 8.1.1.1.3.

On receipt of an uplink assignment message (e.g. PACKET UPLINK ASSIGNMENT, MULTIPLE TBF UPLINK ASSIGNMENT, PACKET TIMESLOT RECONFIGURE or MULTIPLE TBF TIMESLOT RECONFIGURE message) the mobile station shall proceed as follows:

- On reception of an uplink assignment message the mobile station shall stop the instance of timer T3168 associated with the TBF receiving a resource allocation;
- The mobile station shall, after expiry of the TBF starting time, if present, act upon the uplink assignment received for that TBF;
- The mobile station shall then switch to the assigned uplink PDCHs and begin to send RLC data blocks on the assigned PDCH(s). Neither the TLLI (in *A/Gb mode*) nor the G-RNTI (in *Iu mode*) shall be included in any of the uplink RLC data blocks in that case.

A mobile station that supports multiple TBF procedures shall act on the uplink assignment message as follows:

- Upon reception of a PACKET UPLINK ASSIGNMENT message the mobile station shall release all ongoing uplink TBFs not addressed by this message and shall act on the message. If multiple uplink TBFs were requested then the mobile station shall consider those not addressed by this message as rejected and shall stop the corresponding T3168 timer instances. All ongoing downlink TBFs shall be maintained;
- Upon reception of a PACKET TIMESLOT RECONFIGURE message the mobile station shall release all ongoing uplink and downlink TBFs not addressed by this message and shall act on the message. If multiple uplink TBFs were requested then the mobile station shall consider those not addressed by this message as rejected and shall stop the corresponding T3168 timer instances;
- Upon reception of a MULTIPLE TBF UPLINK ASSIGNMENT message the mobile station shall maintain all ongoing TBFs not addressed by this message using its currently allocated TBF parameters and shall act on the message. If a requested uplink TBF is not addressed by this message and the associated timer T3168 is still running the mobile station shall wait for another instance of this message;
- Upon reception of a MULTIPLE TBF TIMESLOT RECONFIGURE message the mobile station shall release all ongoing uplink and downlink TBFs not addressed by this message and shall act on the message. If multiple uplink TBFs were requested then the mobile station shall consider those not addressed by this message as rejected and shall stop the corresponding T3168 timer instances.

When an uplink TBF is established in response to a (EGPRS) PACKET DOWNLINK ACK/NACK message or EGPRS PACKET DOWNLINK ACK/NACK TYPE 2 message with the EARLY\_TBF\_ESTABLISHMENT field set to indicate pre-allocation is required, a network supporting early TBF establishment should keep the uplink TBF open by means of the extended uplink TBF mode operation (see sub-clause 9.3.1b.2).

On receipt of a PACKET ACCESS REJECT message that contains a Reject structure addressed to the mobile station, the mobile station shall stop the instance of timer T3168 associated with each uplink TBF being rejected and indicate a packet access failure to the corresponding upper layers.

If the PACKET ACCESS REJECT message contains a WAIT\_INDICATION field in a Reject structure addressed to the mobile station, it shall proceed as follows:

- If multiple TBF procedures are not supported the mobile station shall start timer T3172 with the indicated value (Wait Indication). The mobile station is not allowed to make a new attempt for uplink TBF establishment in the same cell until timer T3172 expires, but it may attempt uplink TBF establishment in an other cell after successful cell reselection;
- If both the mobile station and the network support multiple TBF procedures the mobile station shall start one instance of timer T3172 for each uplink TBF that was rejected. All ongoing TBFs shall be maintained. The mobile station is not allowed to attempt re-establishment of a rejected uplink TBF in the same cell until its associated instance of timer T3172 expires. It may, however, attempt re-establishment of a rejected uplink TBF in another cell after successful cell reselection. The mobile station may attempt to enter the dedicated mode in the same cell before all instances of timer T3172 have expired. During the time one or more instances of T3172 are running, the mobile station shall ignore all received PACKET PAGING REQUEST messages except paging request to trigger RR connection establishment and paging request including MBMS notification.

If all instances of timer T3168 have expired, the mobile station shall retransmit the (Extended) Channel Request Description information element in the next (EGPRS) PACKET DOWNLINK ACK/NACK message or EGPRS PACKET DOWNLINK ACK/NACK TYPE 2 message or the Channel Request Description information element in the next EGPRS PACKET DOWNLINK ACK/NACK DLMC message unless the (Extended) Channel Request Description has already been transmitted four times in which case the mobile station shall perform an abnormal release with access retry (see sub-clause 8.7.2 and 3GPP TS 44.160). If all the ongoing downlink TBFs are released, including expiry of timer T3192, before expiry of all instances of timer T3168 and no uplink TBFs are either ongoing or have received an uplink assignment with a TBF starting time, the mobile station shall stop all remaining instances of timer T3168 and perform an abnormal release with access retry (see sub-clause 8.7.2 and 3GPP TS 44.160).

#### 8.1.2.5.1 Abnormal cases

If a failure occurs on the mobile station side before a new TBF has been successfully established, the newly reserved resources are released. The subsequent behaviour of the mobile station depends on the type of failure and previous actions:

- If the information in the PACKET UPLINK ASSIGNMENT or MULTIPLE TBF UPLINK ASSIGNMENT message specifies a multislot configuration that the mobile station does not support (see 3GPP TS 45.002), the mobile station shall perform an abnormal release with access retry (see sub-clause 8.7.2 and 3GPP TS 44.160);
- If the mobile station does not support Downlink Dual Carrier but receives a PACKET UPLINK ASSIGNMENT or a MULTIPLE TBF UPLINK ASSIGNMENT message specifying different frequency parameters than those currently in effect for the downlink TBF(s) (see sub-clause 5.5.1.7), the mobile station shall ignore the PACKET UPLINK ASSIGNMENT/ MULTIPLE TBF UPLINK ASSIGNMENT message, continue normal operation of the ongoing downlink TBF(s), and reinitiate the establishment of the uplink TBF(s) unless the establishment of the uplink TBF(s) has already been attempted four times, in which case, the mobile station shall perform the abnormal release with access retry (see sub-clause 8.7.2 and 3GPP TS 44.160);
- If a mobile station in dual transfer mode or MAC-DTM state receives a PACKET UPLINK ASSIGNMENT or a MULTIPLE TBF UPLINK ASSIGNMENT message including frequency parameters for the carrier supporting the dedicated resources, the mobile station shall perform an abnormal release with access retry (see sub-clause 8.7.2 and 3GPP TS 44.160);
- If a failure in the PACKET UPLINK ASSIGNMENT or in the MULTIPLE TBF UPLINK ASSIGNMENT message is due to any other reason, the mobile station shall perform an abnormal release with access retry (see sub-clause 8.7.2);
- If the information in the PACKET TIMESLOT RECONFIGURE or in the MULTIPLE TBF TIMESLOT RECONFIGURE message does not properly specify a set of uplink and downlink PDCH(s) or specifies a multislot configuration that the mobile station does not support (see 3GPP TS 45.002), the mobile station shall perform an abnormal release with access retry (see sub-clause 8.7.2 and 3GPP TS 44.160);
- If the PACKET TIMESLOT RECONFIGURE or the MULTIPLE TBF TIMESLOT RECONFIGURE message does not include a correct UPLINK\_TFI\_ASSIGNMENT field, then the mobile station shall perform an abnormal release with access retry (see sub-clause 8.7.2 and 3GPP TS 44.160);

- If a mobile station in dual transfer mode receives a PACKET TIMESLOT RECONFIGURE or a MULTIPLE TBF TIMESLOT RECONFIGURE message including frequency parameters for the carrier supporting the dedicated resources, the mobile station shall perform an abnormal release with access retry (see sub-clause 8.7.2 and 3GPP TS 44.160);
- If a failure in the PACKET TIMESLOT RECONFIGURE or in the MULTIPLE TBF TIMESLOT RECONFIGURE message is due to any other reason, the mobile station shall perform an abnormal release with access retry (see sub-clause 8.7.2 and 3GPP TS 44.160);
- If both the mobile station and the network support multiple TBF procedures and if any given uplink assignment message provides an uplink TBF allocation for a PFI not indicated in the request for uplink TBF sent by the mobile station, the mobile station shall abort the procedure and perform an abnormal release with access retry (see sub-clause 8.7.2 and 3GPP TS 44.160);
- If both the mobile station and the network support EMST and if any given uplink assignment message provides an uplink resource allocation for a PFI not indicated in the request for uplink resource sent by the mobile station, the mobile station shall abort the procedure and perform an abnormal release with access retry (see sub-clause 8.7.2);
- If both the mobile station and the network support EMST and if any given uplink assignment message includes an assignment for more RLC entities than the mobile station supports or more than one RLC entity is assigned to use same RLC mode to a TBF, the mobile station shall abort the procedure and perform abnormal release with access retry (see sub-clause 8.7.2);
- If a mobile station that does not support Downlink Dual Carrier receives a PACKET UPLINK ASSIGNMENT message, PACKET TIMESLOT RECONFIGURE message, MULTIPLE TBF UPLINK ASSIGNMENT message or a MULTIPLE TBF TIMESLOT RECONFIGURE message that assigns resources on two carriers, the mobile station shall perform an abnormal release with access retry (see sub-clause 8.7.2 and 3GPP TS 44.160);
- If a mobile which supports Downlink Dual Carrier receives a PACKET DOWNLINK ASSIGNMENT message, PACKET TIMESLOT RECONFIGURE message, MULTIPLE TBF DOWNLINK ASSIGNMENT message or a MULTIPLE TBF TIMESLOT RECONFIGURE message that assigns resources on two carriers and those two carriers are not within the same frequency band, the mobile station shall perform an abnormal release with access retry (see sub-clause 8.7.2 and 3GPP TS 44.160);
- If the failure is due to any other reason, the mobile station shall abort the procedure and perform an abnormal release with access retry (see sub-clause 8.7.2 and 3GPP TS 44.160).

8.1.2.6 (void)

8.1.2.7 (void)

### 8.1.2.8 Network initiated abnormal release of downlink TBF

The network may initiate immediate abnormal release of a downlink TBF by transmitting a PACKET TBF RELEASE message to the mobile station on the PACCH.

The mobile station shall immediately stop monitoring its assigned downlink PDCHs. If a valid RRBP field is received as part of the PACKET TBF RELEASE message, the mobile station shall transmit a PACKET CONTROL ACKNOWLEDGMENT message in the uplink radio block specified.

In *A/Gb mode*, if there are no other on-going TBFs, the mobile station in packet transfer mode shall enter packet idle mode; the mobile station in dual transfer mode shall enter dedicated mode. If there is one or more on-going TBFs, the mobile station shall remain in its current mode i.e. packet transfer mode or dual transfer mode. The DRX mode procedures shall be applied, as specified in sub-clause 5.5.1.5.

In *Iu mode*, if no on-going TBFs on SBPSCH exist, the mobile station in MAC-Shared state shall enter the MAC-Idle State; the mobile station in MAC-DTM state shall enter the MAC-Dedicated state. If any on-going TBFs on SBPSCH exist, the mobile station shall remain in its current state, i.e. either MAC-Shared state or MAC-DTM state. The DRX mode procedures shall be applied, as specified in 3GPP TS 44.160.

### 8.1.3 (void)

## 8.1.4 RLC data block transfer during an MBMS radio bearer

### 8.1.4.0 General

For each MBMS radio bearer, the network shall prioritise RLC/MAC control blocks not containing a PACKET DOWNLINK DUMMY CONTROL BLOCK message to be transmitted ahead of RLC data blocks for that MBMS radio bearer. If the network has no other RLC/MAC block to transmit, but wishes to transmit on the downlink, the network may either follow the procedure specified in sub-clause 9.3.1a, to keep the MBMS radio bearer alive or transmit an RLC/MAC control block containing a PACKET DOWNLINK DUMMY CONTROL BLOCK message.

### 8.1.4.1 RLC data block transfer during an MBMS radio bearer

Procedures on receipt of a downlink assignment message (e.g. MBMS ASSIGNMENT message) are specified in sub-clause 7.7.2.2. After switching to the assigned PDCHs, the mobile station shall start a T3190 timer instance for the corresponding MBMS radio bearer and shall attempt to decode every downlink block on the assigned PDCHs.

Additionally, upon reception of an MBMS ASSIGNMENT or MBMS MS\_ID ASSIGNMENT message assigning a specific MS\_ID value to a mobile station, this mobile station shall start a T3290 timer instance for the corresponding MBMS radio bearer, as specified in sub-clause 7.7.2.4.

The mobile station shall restart the related T3190 timer instance whenever receiving a valid RLC/MAC block including the assigned MBMS Bearer Identity. In EGPRS TBF mode T3190 is also restarted when receiving an erroneous RLC data block for which the header is correctly received and which addresses the mobile station. A mobile station with an assigned MS\_ID value shall restart the related T3290 timer instance whenever receiving a valid RLC/MAC block including the corresponding MBMS Bearer Identity and the MS\_ID in the TFI field.

On expiry of a T3290 timer instance, the mobile station shall consider the MS\_ID as released, i.e. it shall no longer answer when polled according to sub-clause 8.1.4.2 below. On expiry of a T3190 timer instance, the mobile station shall consider the related MBMS radio bearer as released and proceed as specified in sub-clause 7.7.1.

### 8.1.4.2 Polling for MBMS Downlink Ack/Nack

If an uplink feedback channel is established, the network may poll any mobile station with an assigned MS\_ID value by setting the (E)S/P bit and a valid RRBP field in the RLC/MAC header of an RLC/MAC block for data transfer containing both the MBMS Bearer Identity and the corresponding MS\_ID value in the TFI field. Whenever a given mobile station is polled, the mobile station shall transmit an MBMS DOWNLINK ACK/NACK message in the uplink radio block specified by the RRBP field, whatever the BSN value of the received RLC data block. In GPRS TBF mode (respectively EGPRS TBF mode), the mobile station shall include the Ack/Nack Description IE (respectively the EGPRS Ack/Nack Description IE) in the message.

The mobile station shall include in the MBMS DOWNLINK ACK/NACK message neighbouring cells measurement results as described in sub-clause 5.6.4. In EGPRS TBF mode, the number of measurement reports included is specified in sub-clause 9.1.8.2.1. In GPRS TBF mode where cell reselection criteria are not fulfilled three measurement reports shall be included.

In EGPRS TBF mode, the mobile station shall react to a poll within an RLC/MAC block for data transfer if the RLC/MAC header is correctly received and addresses the mobile station (i.e. contains both the MBMS Bearer Identity and the corresponding MS\_ID value in the TFI field) regardless whether the RLC data block(s) is(are) correctly received or not.

The mobile station shall notify, whenever possible, the network of the release of the MS\_ID (see note), for that MBMS radio bearer, on the mobile station side, by setting the MS\_ID Release Indication bit to "1" in the MBMS DOWNLINK ACK/NACK message. Any procedure triggering the release of the MS\_ID on the mobile station side shall not be delayed by such release indication (otherwise such release indication shall not be sent).

**NOTE:** The mobile station may need to release the related MBMS session for whatever reason (e.g. due to cell reselection, start of the reception of a higher priority MBMS session whose MBMS radio bearer description does not allow the mobile station to receive it in parallel with the current MBMS session, start of a CS connection).

Whenever the network receives a valid RLC/MAC control message containing an assigned MS\_ID value, it shall reset the counter N3105 for that MS\_ID. The network shall increment the counter N3105 for a given MS\_ID for each radio block, allocated via the polling procedure to the mobile station identified by that MS\_ID value, for which no RLC/MAC control message is received. If  $N3105 = N3105\_MBMS\_MAX$ , the network shall release the MS\_ID (i.e. shall internally remove the association between the MS\_ID value and the mobile station identified during the MBMS address assignment procedure) and start timer T3195 for that MS\_ID. When T3195 elapses, the network may reuse the corresponding MS\_ID value.

### 8.1.4.3 Reconfiguration of an MBMS radio bearer

#### 8.1.4.3.1 Individual reassignment of an MS\_ID

The network may modify or delete the MS\_ID previously assigned to a given mobile station by sending an MBMS MS\_ID ASSIGNMENT message on the PACCH/D, containing the current and, in case of a reassignment, the new MS\_ID value.

The mobile station shall be addressed with the Global TFI, containing the DOWNLINK\_TFI field, which includes the MBMS Bearer Identity of the MBMS radio bearer and the current MS\_ID of the mobile station the message relates to. The size of the new MS\_ID, if present, shall be equal to the one of the current MS\_ID. If the new MS\_ID is present, the network may include the *Packet Timing Advance IE*.

When modifying or deleting the current MS\_ID, the MBMS MS\_ID ASSIGNMENT message shall include a current MS\_ID expiry time.

In response to an MBMS DOWNLINK ACK/NACK message with the MS\_ID Release Indication bit set to "1" (see sub-clause 8.1.4.2), the network may send an MBMS MS\_ID ASSIGNMENT message to the mobile station, deleting the MS\_ID previously assigned to that mobile station on that MBMS radio bearer and setting the current MS\_ID expiry time to the point in time when the message is transmitted to the mobile station, without further polling the mobile station on that MBMS radio bearer. The network shall then start timer T3199 for the current MS\_ID.

Upon reception of an MBMS MS\_ID ASSIGNMENT message, modifying or deleting the current MS\_ID, the addressed mobile station shall consider the current MS\_ID as released at the point in time denoted by the current MS\_ID expiry time. If a new MS\_ID is included in the message, the mobile station shall consider the new MS\_ID as valid and restart timer T3290 at the point in time denoted by the current MS\_ID expiry time and react when polled with the new MS\_ID, according to sub-clause 8.1.4.2.

If a valid RRBP field is received as part of the MBMS MS\_ID ASSIGNMENT message, the mobile station shall respond with a PACKET CONTROL ACKNOWLEDGEMENT message in the specified uplink radio block.

If the network does not receive the PACKET CONTROL ACKNOWLEDGEMENT message in the specified radio block, it shall increment counter N3109 for the current MS\_ID and may retransmit the MBMS MS\_ID ASSIGNMENT message addressing the mobile station with the current MS\_ID. If counter  $N3109 = N3109\_MAX$  or at the point in time denoted by the current MS\_ID expiry time without receiving a PACKET CONTROL ACKNOWLEDGEMENT message, whatever occurs first, the network shall start timer T3199 for the current MS\_ID. While timer T3199 is running for the current MS\_ID, the network shall not include the current MS\_ID in any RLC/MAC block belonging to that MBMS radio bearer. When timer T3199 expires for the current MS\_ID, the network may reuse the current MS\_ID resource. At the point in time denoted by the current MS\_ID expiry time the network shall start timer T3199 for the new MS\_ID, if present. While timer T3199 is running for the new MS\_ID, the network shall not include the new MS\_ID in any RLC/MAC block belonging to that MBMS radio bearer. When timer T3199 expires for the new MS\_ID, the network may reuse the new MS\_ID resource.

When modifying the current MS\_ID, after the point in time denoted by the current MS\_ID expiry time, the network shall address the mobile station with the new MS\_ID, unless counter N3109 for the current MS\_ID equals  $N3109\_MAX$  or within the point in time denoted by the current MS\_ID expiry time the network has not received a PACKET CONTROL ACKNOWLEDGEMENT message from the polled mobile station.

#### 8.1.4.3.2 Reassignment of the MBMS Bearer Identity

The network may reassign the MBMS Bearer Identity previously assigned to a given MBMS radio bearer by sending an MBMS ASSIGNMENT (NON-DISTRIBUTION) message on the PACCH/D, including the current MBMS Bearer Identity (in the most significant bit(s) of the DOWNLINK\_TFI field contained in the Global TFI), explicitly redefining



(i.e. modifying the length and/or value of) such MBMS Bearer Identity and implicitly deleting or redefining MS\_IDs assigned to that MBMS radio bearer as described below.

When reassigning the MBMS Bearer Identity the network shall not reuse the TFI values including the old MBMS Bearer Identity in the most significant bit(s) of the TFI field.

If the mobile station receives more than one MBMS ASSIGNMENT (NON-DISTRIBUTION) message for a given MBMS radio bearer, it shall act upon the most recently received message and shall ignore the previous message.

If a valid RRBP field is received as part of the MBMS ASSIGNMENT (NON-DISTRIBUTION) message, the mobile station identified by the corresponding MS\_ID shall respond with a PACKET CONTROL ACKNOWLEDGEMENT message in the specified uplink radio block.

Any redefinition of an MBMS Bearer Identity and any deletion or redefinition of MS\_IDs shall apply at the point in time denoted by the MBMS radio bearer starting time, if present, and immediately otherwise:

- if the new MBMS Bearer Identity field has the same length as the current one all previously assigned MS\_ID values shall be considered still valid;
- if the new MBMS Bearer Identity field is x bits shorter than the current one, all previously assigned MS\_ID values shall be implicitly redefined by adding x most significant bits set to zero and shall be considered all valid;
- if the new MBMS Bearer Identity field is x bits longer than the current one, all previously assigned MS\_ID values characterized by their x most significant bits equal to zero shall be implicitly redefined by removing these x most significant bits and still considered valid. All other assigned MS\_ID values shall be considered as invalid and discarded.

At the point in time denoted by the MBMS radio bearer starting time, if present, and immediately otherwise, a mobile station shall restart timer T3190 for the newly assigned MBMS Bearer Identity. The mobile station shall restart timer T3190 whenever receiving an RLC/MAC block including the new MBMS Bearer Identity. If timer T3190 expires, the mobile station shall consider the MBMS radio bearer as released and proceed as specified in sub-clause 7.7.1. At the point in time denoted by the MBMS radio bearer starting time, if present, and immediately otherwise, a mobile station with an assigned MS\_ID value shall start timer T3290. The mobile station shall restart timer T3290 whenever receiving an RLC/MAC block including both the new MBMS Bearer Identity and the new MS\_ID in the TFI field.

The following table illustrates the definition of the new MS\_ID upon reassignment of the MBMS Bearer Identity:

Table 8.1.4.3.2.1: Reassignment of MBMS Bearer Identity and MS\_ID

New Current		Bearer ID	MS_ID	Bearer ID	MS_ID	Bearer ID	MS_ID	Bearer ID	MS_ID	Bearer ID	MS_ID
Bearer ID	MS_ID	5 bits	-	4 bits	1 bit	3 bits	2 bits	2 bits	3 bits	1 bit	4 bits
5 bits	-	No MS_ID		New MS_IDs available		New MS_IDs available		New MS_IDs available		New MS_IDs available	
4 bits	1 bit	Discard current MS_ID		Keep current MS_ID		x → 0x New MS_IDs available		x → 00x New MS_IDs available		x → 000x New MS_IDs available	
3 bits	2 bits			0x → x 1x → Discard current MS_ID		Keep current MS_ID		xx → 0xx New MS_IDs available		xx → 00xx New MS_IDs available	
2 bits	3 bits			00x → x Other → Discard current MS_ID		0xx → xx 1xx → Discard current MS_ID		Keep current MS_ID		xxx → 0xxx New MS_IDs available	
1 bit	4 bits			000x → x Other → Discard current MS_ID		00xx → xx Other → Discard current MS_ID		0xxx → xxx 1xxx → Discard current MS_ID		Keep current MS_ID	
NOTE: The following notations are used: "No MS_ID": no MS_ID available. MS is not allowed to use feedback "Discard current MS_ID": MS shall discard the current MS_ID. MS is no longer allowed to use feedback "New MS_IDs available": MS_IDs are made available for incoming MSs "Keep current MS_ID": MS shall keep its current MS_ID and use feedback (i.e. reply when polled with this MS_ID) n → m: current MS_ID → new MS_ID. Defines the value of the new MS_ID based on the value of the current MS_ID "x" → "x" means the same bit value is used											

The network shall start timer T3191 at the point in time denoted by the MBMS radio bearer starting time, if present, and immediately otherwise. When timer T3191 expires the network may reuse the TFI values corresponding to the old MBMS Bearer Identity, i.e. the TFI values including the old MBMS Bearer Identity in the most significant bit(s) of the TFI field.

### 8.1.4.3.3 Resource reassignment for an MBMS radio bearer

The network may initiate resource reassignment for an MBMS radio bearer by sending the MBMS ASSIGNMENT (NON-DISTRIBUTION) message, including the MBMS Bearer Identity (in the most significant bit(s) of the DOWNLINK\_TFI field contained in the Global TFI), on the PACCH/D of the MBMS radio bearer. During the reassignment of the MBMS radio bearer its associated MBMS Bearer Identity may be changed.

In case of partial or complete overlap between the old and the new resource configuration on the downlink, the MBMS Bearer Identity shall be changed.

If the MBMS Bearer Identity is changed the network shall not reuse the TFI values including the old MBMS Bearer Identity in the most significant bit(s) of the TFI field.

If the mobile station receives more than one MBMS ASSIGNMENT (NON-DISTRIBUTION) message for a given MBMS radio bearer, it shall act upon the most recently received message and shall ignore the previous message.

If a valid RRBP field is received as part of the MBMS ASSIGNMENT (NON-DISTRIBUTION) message, the mobile station identified by the corresponding MS\_ID shall respond with a PACKET CONTROL ACKNOWLEDGEMENT message in the specified uplink radio block.

On receipt of an MBMS ASSIGNMENT (NON-DISTRIBUTION) message, and at the point in time denoted by the MBMS radio bearer starting time, if present, the mobile station shall switch to the assigned PDCHs. Upon switching to the assigned PDCHs the mobile station shall restart timer T3190 for the newly assigned MBMS radio bearer. The mobile station shall restart timer T3190 whenever receiving a valid RLC/MAC block belonging to that MBMS radio bearer. In EGPRS TBF mode T3190 is also restarted when receiving an erroneous RLC data block for which the header is correctly received and which addresses the mobile station. If timer T3190 expires, the mobile station shall consider the MBMS radio bearer as released and proceed as specified in sub-clause 7.7.1. Upon switching to the assigned PDCHs, a mobile station with an assigned MS\_ID value shall restart timer T3290. The mobile station shall restart timer T3290 whenever receiving an RLC/MAC block including both the MBMS Bearer Identity and the MS\_ID in the TFI field.

With an MBMS ASSIGNMENT (NON-DISTRIBUTION) message the network may explicitly redefine (i.e. modify the length and/or value of) the MBMS Bearer Identity of an MBMS radio bearer and implicitly delete or redefine MS\_IDs assigned to that MBMS radio bearer as specified in sub-clause 8.1.4.3.2. Any redefinition of an MBMS Bearer Identity and any deletion or redefinition of MS\_IDs shall only be effective as of switching to the assigned PDCHs.

After resource reassignment the mobile station shall receive system information messages and paging messages on the (P)BCCH and the (P)CCCH or on the PACCH of the MBMS radio bearer, depending on the value of the MBMS In-band Signalling Indicator information element included in the MBMS ASSIGNMENT (NON-DISTRIBUTION) message and on the presence of an assigned MS\_ID value.

The network shall start timer T3191 at the point in time denoted by the MBMS radio bearer starting time, if present, and immediately otherwise. When timer T3191 expires the network may reuse the TFI values corresponding to the old MBMS Bearer Identity, i.e. the TFI values including the old MBMS Bearer Identity in the most significant bit(s) of the TFI field, on the old resource configuration.

#### 8.1.4.4 Network initiated release of an MBMS radio bearer

The network may initiate the normal or abnormal release of an MBMS radio bearer by transmitting a PACKET TBF RELEASE message to the mobile station(s) on the PACCH.

The following applies when the PACKET TBF RELEASE message is used for releasing an MBMS radio bearer:

- the Global TFI shall always contain the DOWNLINK\_TFI field. The most significant bit(s) of the DOWNLINK\_TFI field denote(s) the MBMS Bearer Identity of the MBMS radio bearer released by the message;
- the UPLINK\_RELEASE field shall be ignored by the mobile station;
- the DOWNLINK\_RELEASE field shall always be set to the value "1" by the network to indicate that the MBMS radio bearer is released.

NOTE: The network may retransmit the PACKET TBF RELEASE message to increase the probability of its correct reception. Timer T3191 is (re)started every time the PACKET TBF RELEASE message is sent. When timer T3191 expires for the MBMS radio bearer, then the network may reuse all the TFIs related to the MBMS radio bearer.

Upon receipt of a PACKET TBF RELEASE message referring to an MBMS radio bearer the mobile station is receiving, the mobile station shall immediately consider the MBMS Bearer Identity, and the MS\_ID if assigned, as released, and stop timers T3190 and T3290.

If the mobile station in broadcast/multicast receive mode is not receiving any other MBMS radio bearers, it shall enter packet idle mode and apply the DRX mode procedures as specified in sub-clause 5.5.1.5, otherwise it shall remain in broadcast/multicast receive mode.

#### 8.1.4.5 Suspension/Resumption of the reception of an MBMS radio bearer

In case a mobile station that supports multiple TBF procedures suspends the reception of an MBMS radio bearer for whatever reason, the mobile station may retain the MBMS bearer description for such MBMS radio bearer until the expiry of the T3190 timer instance for the corresponding MBMS radio bearer. The corresponding MBMS bearer description shall be deleted if the mobile station completes a cell reselection or the session duration timer for this MBMS session in the mobile station expires.

When the mobile station returns to packet idle mode or completes the reception of higher mobile station-specific priority MBMS session(s), preventing the mobile station from receiving the suspended MBMS session, still remaining in broadcast/multicast receive mode,

- if the MBMS bearer description is still stored in the mobile station, then the mobile station may attempt to resume the reception of the suspended MBMS session (re-entering broadcast/multicast receive mode if the mobile station has previously left it);
- otherwise the mobile station shall repeat the MBMS packet access procedure for the MBMS session, as specified in sub-clause 7.7.1, unless the session duration timer for this MBMS session in the mobile station has expired.

## 8.1.5 Multiple MBMS radio bearers

### 8.1.5.1 Transmission of multiple MBMS radio bearers

On a PDCH on which multiple MBMS radio bearers are multiplexed, the TFI value(s) including an MBMS Bearer Identity (in the most significant bit(s) of the TFI field) shall differ from all the other TFI values including any other MBMS Bearer Identity (in the most significant bit(s) of the TFI field).

### 8.1.5.2 Reception of multiple MBMS radio bearers

#### 8.1.5.2.1 General

The reception of multiple MBMS radio bearers depends on the capabilities of the mobile station. If the mobile station supports multiple TBF procedures and MBMS, it shall be able to support the reception of multiple MBMS radio bearers.

In this sub-clause (and sub-clauses 8.1.5.2.2 to 8.1.5.2.7) the priority is mobile station-specific and allows for prioritisation between MBMS sessions on a per-mobile station basis. If two or more MBMS sessions have the same priority, the mobile station shall perform an implementation-dependent selection of the MBMS session with the highest priority so the resulting priorities are distinct for each MBMS session.

The mobile station shall be able, according to its capabilities, to receive as many MBMS sessions as possible in decreasing order of priority, and to transmit MBMS DOWNLINK ACK/NACK messages (when applicable) for as many MBMS sessions as possible in decreasing order of priority.

**NOTE:** Depending on the radio resources allocated for the MBMS radio bearers, a mobile station may not be capable of transmitting MBMS DOWNLINK ACK/NACK messages on all associated uplink feedback channels.

If a mobile station is receiving multiple MBMS radio bearers and the mobile station has an MS\_ID on at least one MBMS radio bearer where the network has indicated that system information for the serving cell and paging messages are sent on the PACCH/D, then the mobile station shall not read the system information on the (P)BCCH and shall not monitor its paging group on the (P)CCCH in parallel to the MBMS radio bearers.

If a mobile station is receiving multiple MBMS radio bearers and the mobile station has no MS\_ID on any of the MBMS radio bearers where the network has indicated that system information for the serving cell and paging messages are sent on the PACCH/D, then the mobile station shall not read the system information on the (P)BCCH and shall monitor its paging group on the (P)CCCH in parallel to the MBMS radio bearers.

#### 8.1.5.2.2 Reception of notification of lower priority MBMS session whilst receiving higher priority MBMS session(s)

If the mobile station in broadcast/multicast receive mode receives a notification of a lower priority MBMS session which includes the MBMS bearer description:

- if the capabilities of the mobile station allow, the mobile station shall receive that MBMS session in parallel with the higher priority MBMS session(s), provided the requirements defined in sub-clause 8.1.5.2.1 are fulfilled;
- otherwise, the mobile station shall discard the notification.

If the mobile station in broadcast/multicast receive mode receives a notification of a lower priority MBMS session which does not include the MBMS bearer description and requests the counting procedure, the mobile station shall not perform the MBMS packet access procedure.

#### 8.1.5.2.3 Reception of assignment of lower priority MBMS session whilst receiving higher priority MBMS session(s)

If the mobile station in broadcast/multicast receive mode receives an assignment for a lower priority MBMS session, the mobile station shall act upon the assignment provided the requirements defined in sub-clause 8.1.5.2.1 are fulfilled.

#### 8.1.5.2.4 Reception of notification of higher priority MBMS session whilst receiving lower priority MBMS session(s)

If the mobile station in broadcast/multicast receive mode receives a notification of a higher priority MBMS session which includes the MBMS bearer description, the mobile station shall act upon the MBMS bearer description and receive in parallel other lower priority MBMS sessions according to the requirements defined in sub-clause 8.1.5.2.1.

If the mobile station in broadcast/multicast receive mode receives a notification of a higher priority MBMS session which does not include the MBMS bearer description and requests the counting procedure, then the mobile station shall suspend the reception of the lower priority MBMS session(s) and perform the MBMS packet access procedure for the higher priority MBMS session, as specified in sub-clause 7.7.1. After performing the MBMS packet access procedure, if the MBMS bearer description(s) for the suspended lower priority MBMS session(s) is (are) still stored in the mobile station, then the mobile station may attempt to resume the reception of the suspended MBMS session(s) (see sub-clause 8.1.4.5).

#### 8.1.5.2.5 Reception of assignment of higher priority MBMS session whilst receiving lower priority MBMS session(s)

If the mobile station in broadcast/multicast receive mode receives an assignment for a higher priority MBMS session, the mobile station shall act upon the assignment and may drop lower priority MBMS sessions following the requirements defined in sub-clause 8.1.5.2.1.

#### 8.1.5.2.6 Cell change whilst receiving multiple MBMS sessions (with MBMS supported by the network in the target cell)

When the mobile station reselects a new (target) cell, the mobile station shall according to its capabilities:

- first perform fast reception resumption (see sub-clause 8.1.6.2) of as many MBMS sessions as possible in decreasing order of priority, for the sessions for which the mobile station has received in the old cell MBMS NEIGHBOURING CELL INFORMATION messages containing the MBMS bearer description of these sessions in this target cell;

NOTE 1: The mobile station shall not perform MBMS packet access procedure for requesting an MS\_ID for any MBMS session, with an associated uplink feedback channel, whose priority is lower than the priority of at least one of the MBMS sessions for which the MBMS bearer description is not known.

- then perform MBMS packet access and establishment procedure as specified in sub-clause 7.7 for the sessions for which the MBMS bearer description is not known, in decreasing order of priority. The mobile station shall not operate two concurrent MBMS packet access and establishment procedures.

NOTE 2: The MBMS packet access procedure is performed in passive mode (i.e. the mobile station notifies the network in the MBMS SERVICE REQUEST message that it shall not be counted) for any MBMS session whose priority is lower than the priority of at least one of the MBMS sessions already resumed. The mobile station may then perform MBMS packet access procedure for requesting an MS\_ID for the remaining MBMS sessions, with an associated uplink feedback channel, following the requirements defined in sub-clause 8.1.5.2.1.

NOTE 3: The mobile station shall not perform an MBMS packet access procedure for an MBMS session, if the session duration timer for this MBMS session in the mobile station has expired.

#### 8.1.5.2.7 Resource reassignment for at least one of the received MBMS radio bearers

If a mobile station is receiving multiple MBMS radio bearers and any of these is reconfigured by the network in a way that the reception of all of them is no longer consistent with the capabilities of the mobile station, then the mobile station shall continue receiving the highest priority MBMS session and as many as possible of the other MBMS sessions, following the requirements defined in sub-clause 8.1.5.2.1.

## 8.1.6 MBMS reception resumption after cell reselection

### 8.1.6.1 Default behaviour

If a mobile station in broadcast/multicast receive mode reselects a new (target) cell for which it does not have the description of (any of) the MBMS radio bearer(s) being allocated in this target cell for the MBMS session(s) the mobile station was receiving in the old serving cell, the mobile station shall follow the default behaviour in the target cell, as described in this sub-clause. Otherwise, the mobile station shall perform fast reception resumption, as described in sub-clause 8.1.6.2.

In the target cell, the mobile station shall first perform the acquisition of the system information on the (P)BCCH.

If the *GPRS Cell Options* IE denotes that the MBMS procedures are supported by the target cell, the mobile station shall then perform the MBMS packet access and establishment procedures, as specified in sub-clause 7.7, for the MBMS session the mobile station was receiving in the old serving cell.

In case of reception of multiple sessions, the mobile station shall obey the procedures described in sub-clause 8.1.5.2.6.

### 8.1.6.2 Fast reception resumption

If a mobile station in broadcast/multicast receive mode reselects a new (target) cell for which it has received the description of (at least one of) the MBMS radio bearer(s) being allocated in this target cell for the MBMS session(s) the mobile station was receiving in the old serving cell (see sub-clauses 5.5.1.1 and 7.7.3), the mobile station shall perform fast reception resumption in the target cell, as described in this sub-clause. Otherwise, the mobile station shall follow the default behaviour, as described in sub-clause 8.1.6.1.

In the target cell, the mobile station shall immediately resume the reception of the MBMS session for which the MBMS bearer description is known from the old serving cell, without first performing the acquisition of the system information. If the mobile station fails to resume the reception of the MBMS session for any reason and does not have any other MBMS bearer description known for any other MBMS session possibly received in the old serving cell, the mobile station shall then follow the default behaviour (see sub-clause 8.1.6.1).

The acquisition of the system information shall be performed simultaneously with the reception of the MBMS session. If the network has indicated that the system information for the resumed MBMS session is not sent on the PACCH (with the MBMS In-band Signalling Indicator information element included in the MBMS NEIGHBOURING CELL INFORMATION message transmitted in the old serving cell), the mobile station shall perform the acquisition of the system information on the (P)BCCH. In this case, the reception of the MBMS session may need to be suspended during such acquisition. The mobile station may then attempt to resume the reception of the suspended MBMS session, according to the requirements and the procedures described in sub-clause 8.1.4.5. If the network has indicated that the system information for the resumed MBMS session is sent on the PACCH, the mobile station shall perform the acquisition of the system information on the PACCH, as described in sub-clause 5.5.2.1.3b.

If the mobile station has received the indication (via the MBMS NEIGHBOURING CELL INFORMATION message transmitted in the old serving cell) that, for the MBMS radio bearer corresponding to the resumed MBMS session, an uplink feedback channel is established in the new cell, the mobile station initiates the MBMS packet access procedure either:

- on the MPRACH, if the mobile station is in DRX mode (e.g. it is not involved in a *routing area update* procedure) and received the indication that an MPRACH is allocated on the uplink feedback channel (sub-clause 7.7.1.4), or
- on a PCCCH (sub-clause 7.7.1.2) or,
- if a packet control channel is not allocated in the cell, on a CCCH (sub-clause 7.7.1.3).

In case of reception of multiple sessions, the mobile station shall obey the procedures described in sub-clause 8.1.5.2.6.

## 8.1.7 Packet Application Information

### 8.1.7.1 General

The Packet Application Transfer procedure enables an application on the network side to transfer Application data to a mobile station.

The network may send the PACKET APPLICATION INFORMATION message to a mobile station in packet transfer mode or in dual transfer mode on the PACCH with one of the following applications:

### 8.1.7.2 Earthquake and Tsunami Warning System (ETWS)

The PACKET APPLICATION INFORMATION message enables the network to transfer an ETWS Primary Notification message, see 3GPP TS 23.041, to a mobile station.

A mobile station operating in packet transfer mode or in dual transfer mode may receive a PACKET APPLICATION INFORMATION message on the PACCH. Since this message may be segmented across more than two RLC/MAC control blocks, by using extended RLC/MAC control message segmentation, the mobile station shall attempt to acquire all segments of the PACKET APPLICATION INFORMATION message before attempting to decode the message. Upon receiving the complete PACKET APPLICATION INFORMATION message the ETWS Primary Notification message shall be sent to upper layers.

## 8.1.8 Dynamic Timeslot Reduction

### 8.1.8.1 General

Dynamic Timeslot Reduction (DTR) allows the network to command the mobile station in packet transfer mode to reduce the number of downlink timeslots that it is required to monitor during inactivity periods of a TBF. The network should use DTR only when extended uplink TBF mode with EXT\_UTBF\_NODATA set to '1' and/or delayed downlink TBF release are used.

The network orders a mobile station that supports DTR to reduce the number of downlink timeslots it shall monitor during the inactivity periods of a TBF (as specified for delayed downlink TBF release and extended uplink TBF mode) by sending it DTR information as defined in sub-clause 8.1.8.2.

The mobile station shall indicate its support for DTR in the MS Radio Access Capabilities IE (see 3GPP TS 24.008).

### 8.1.8.2 DTR Activation

The network shall send DTR information including the TN/PDCH-pair field indicating the timeslot number (BTTI configuration) or the PDCH-pair number (RTTI configuration) and the carrier ID (if the mobile station is in dual carrier configuration) of the timeslot or the PDCH-pair the mobile station shall monitor for USFs and downlink RLC/MAC blocks while in DTR mode. A mobile station with an assigned uplink TBF shall ignore the DTR information in case the indicated timeslot or PDCH-pair is not within the timeslots assigned to the uplink TBF. A mobile station with an assigned downlink TBF shall ignore the DTR information if the indicated timeslot or PDCH-pair does not correspond to a timeslot or PDCH-pair assigned to the downlink TBF. For a DLMC configuration the network shall send DTR information including the TN/PDCH-pair field indicating the timeslot number (BTTI configuration) or the PDCH-pair number (RTTI configuration) of the timeslot or the PDCH-pair the mobile station shall monitor for radio blocks on the downlink carrier used for fall back according to a regular pre-determined interval (see sub-clause 5.13).

In addition, the DTR information may indicate the mobile station is only required to monitor a sub-set of the radio blocks on the monitored timeslot/PDCH-pair, as indicated by the *DTR Blks* parameter.

During a downlink TBF, the network may transmit the DTR information within downlink RLC data blocks of the TBF (see sub-clause 10.3a.1). During an uplink TBF, the network may transmit the DTR information within a PACKET UPLINK ACK/NACK message. If DTR information is received in a PACKET UPLINK ACK/NACK message and an RLC data block in the same block period, the mobile station shall ignore the DTR information received in the RLC data block.

A mobile station not already in DTR mode shall enter DTR mode and start monitoring only the indicated PDCH or PDCH-pair (and if applicable, carrier) within the reaction time specified in 3GPP TS 45.010, when:

- DTR information was included in whichever of the following was the most recently received:
  - i) any PACKET UPLINK ACK/NACK message (applicable if the mobile station has an ongoing uplink TBF) and
  - ii) the RLC data block with BSN equal to  $V(Q) - 1$  modulo SNS (applicable if the mobile station has an ongoing downlink TBF) and
- $V(R) = V(Q)$ , if the mobile station has an ongoing downlink TBF, and
- if the mobile station has an ongoing uplink TBF, the RLC data block with BSN =  $V(S)$  is not available and either:
  - $V(A) = V(S)$ , or
  - $V(A) < V(S) \bmod SNS$ , the most recently received pre-emptive transmission bit is set to '0', and no element of  $V(B)$  has the value NACKED (for RLC acknowledged mode).

NOTE 1: If the network includes DTR information in a PACKET UPLINK ACK/NACK message which includes one or more NACK indications, and the pre-emptive transmission bit is set to '0', upper layer PDUs may be delayed due to the limited uplink bandwidth available when in DTR mode. In order to ensure there are no delays in the delivery of upper layer uplink PDUs, the network should not send DTR information in a PACKET UPLINK ACK/NACK message which includes multiple NACK indications.

NOTE 2: The network may not be able to determine the exact point when the mobile station enters DTR but may use appropriate means (e.g. polling on a timeslot other than the monitored timeslot) to confirm that the MS has entered DTR.

A mobile station already in DTR mode shall assume the DTR information is unchanged and shall therefore remain in DTR mode, i.e. the network shall ensure the DTR information is kept unchanged for this MS while it remains in DTR mode.

The mobile station shall respond to any poll for PACKET DOWNLINK ACK/NACK or PACKET CONTROL ACKNOWLEDGMENT message received in radio block periods up to and including the one in which the mobile station is triggered to enter DTR mode (i.e. in which all conditions for entering DTR, as specified in this sub-clause, are met), as specified in sub-clause 8.1.2.2 and sub-clause 8.6. The mobile station shall respond to any poll for PACKET DOWNLINK ACK/NACK or PACKET CONTROL ACKNOWLEDGMENT message if it was received on the timeslot/PDCH-pair to be monitored during DTR mode and was received during a radio block period after the one in which the mobile station is triggered to enter DTR mode.

When a mobile station operating concurrent TBFs in both directions is ordered to enter DTR mode, it shall apply DTR mode on both TBFs. The mobile station shall monitor the indicated PDCH or PDCH-pair for USFs and downlink RLC/MAC blocks.

### 8.1.8.3 Resumption to normal operation

The mobile station shall exit DTR mode within the reaction time specified in 3GPP TS 45.010:

- when an RLC data block with BSN equal to  $V(S)$  is transmitted and the medium access mode is Dynamic Allocation;
- when an EGPRS RLC/MAC block for data transfer including BSN higher than  $V(R)$  modulo SNS is received;
- when an RLC data block with BSN equal to  $V(R)$  not including a valid DTR information is received;
- upon reception of an assignment message (PACKET DOWNLINK ASSIGNMENT, PACKET UPLINK ASSIGNMENT, PACKET TIMESLOT RECONFIGURE, PACKET CS RELEASE INDICATION) or PACKET UPLINK ACK/NACK message without a DTR information. If a TBF starting time information element is present in the received assignment message, the mobile station shall wait until the indicated TBF starting time before switching to the assigned PDCHs and exiting DTR mode;
- upon reception of a PACKET PDCH RELEASE message releasing the monitored PDCH/PDCH-pair when the mobile station shall act as specified in sub-clause 8.2.



## 8.2 Packet PDCH Release

The network may broadcast the PACKET PDCH RELEASE message on PACCH to indicate one or more timeslots is no longer available for packet data service. In the case where any of these timeslots belong to an assigned PDCH pair for a TBF in RTTI configuration, the mobile stations that use any of these time slots within their assigned TBF(s) in RTTI configuration shall consider both timeslots that constitute such a PDCH pair as being released. When a mobile station receives a PACKET PDCH RELEASE message, it shall immediately stop transmitting and receiving on all assigned PDCHs, which are indicated as not present in the TIMESLOTS\_AVAILABLE field, remove those PDCHs from its list of assigned PDCHs.

If all of the mobile station's assigned PDCHs are removed from its list of assigned PDCHs, and, if at least one uplink TBF was in progress, the mobile station shall perform an abnormal release with access retry (see sub-clause 8.7.2 and 3GPP TS 44.160). If no uplink TBFs were in progress, the mobile station shall perform an abnormal release without retry (see sub-clause 8.7.1).

If the mobile station has been assigned an uplink control timeslot(s) and the PACKET PDCH RELEASE message releases this PDCH/PDCH pair, and if at least one uplink TBF was in progress, the mobile station shall perform an abnormal release with access retry (3GPP TS 44.160). If no uplink TBFs were in progress, the mobile station shall perform an abnormal release without retry (see sub-clause 8.7.1).

If the current timeslot configuration requires Shifted USF operation (see sub-clause 8.1.1.2.4) and the PACKET PDCH RELEASE message modifies the configuration in such a way that Shifted USF operation is no longer required then normal USF operation shall apply after a suitable reaction time as defined in 3GPP TS 45.010.

## 8.3 Procedure for measurement report sending in Packet Transfer mode

The procedure for NC measurement report sending shall be initiated by the mobile station at expiry of the NC measurement report interval timer T3158 (see sub-clause 5.6.1 and 3GPP TS 44.160). At expiry of the timer T3158 the mobile station shall restart the timer T3158, perform the measurements and send either the PACKET MEASUREMENT REPORT message containing the "NC measurement report struct" or the PACKET ENHANCED MEASUREMENT REPORT message on PACCH.

Following a downlink TBF establishment, the PACKET MEASUREMENT REPORT or PACKET ENHANCED MEASUREMENT REPORT message shall not be sent on the uplink PACCH associated with this TBF until two Packet Ack/Nack ((EGPRS) PACKET DOWNLINK ACK/NACK or EGPRS PACKET DOWNLINK ACK/NACK TYPE 2 or EGPRS PACKET DOWNLINK ACK/NACK TYPE 3 or EGPRS PACKET DOWNLINK ACK/NACK DLNC) messages have been sent to the network.

## 8.4 Network controlled cell reselection procedure

A cell reselection is controlled either by the mobile station or by the network.

When the cell reselection is controlled by the mobile station, the mobile station shall apply the cell reselection procedure defined in sub-clause 5.5.1.1 (*A/Gb mode*) or 3GPP TS 44.160.

When a cell reselection is initiated by the network for an individual mobile station, the cell change order procedure is started by sending a PACKET CELL CHANGE ORDER message to the mobile station on the PCCCH or PACCH.

The PACKET CELL CHANGE ORDER message contains:

- The characteristics of the new cell that are necessary to identify it (i.e. BSIC + BCCH frequency);
- The NC measurement parameters valid for the mobile station in the new cell (NETWORK\_CONTROL\_ORDER and optionally: NC\_NON\_DRX\_PERIOD, NC\_REPORTING\_PERIOD\_I and NC\_REPORTING\_PERIOD\_T);
- The IMMEDIATE\_REL parameter;
- The CCN\_ACTIVE parameter and optionally the CONTAINER\_ID referring to the one included in received instances of the PACKET NEIGHBOUR CELL DATA message.

For a multi-RAT mobile station supporting UTRAN, the PACKET CELL CHANGE ORDER message may contain information on a UTRAN target cell, together with the IMMEDIATE\_REL parameter; the establishment of UTRAN channel(s) and subsequent measurement reporting are defined in 3GPP TS 25.331.

For a multi-RAT mobile station supporting "CCN towards E-UTRAN, E-UTRAN Neighbour Cell measurement reporting and Network controlled cell reselection to E-UTRAN", the PACKET CELL CHANGE ORDER message may contain information on an E-UTRAN target cell; in this case, the establishment of channel(s) and subsequent measurement reporting are defined in 3GPP TS 36.331.

Upon receipt of the PACKET CELL CHANGE ORDER message the mobile station shall start timer T3174 and apply the cell reselection procedure defined in sub-clause 5.5.1.1 (*A/Gb mode*) or 3GPP TS 44.160, with the additional rule that an immediate abort of operation in the old cell may be required by the network through the IMMEDIATE\_REL field, except for the acknowledgement, by means of a PACKET CONTROL ACKNOWLEDGEMENT message, of a valid RRBP field possibly included in the PACKET CELL CHANGE ORDER message. A UTRAN capable mobile station ordered to a UTRAN cell shall obey the PACKET CELL CHANGE ORDER message irrespective of whether the target cell is known or not known (see 3GPP TS 25.133 and 3GPP TS 25.123); an E-UTRAN capable mobile station ordered to an E-UTRAN cell shall obey the PACKET CELL CHANGE ORDER message irrespective of whether the target cell is known or not known (see 3GPP TS 36.133).

If the timers related to measurement reporting expire while the reselection procedure has not yet been completed, these timers shall be restarted so that the mobile station resumes the measurement reporting procedures once camped on the new cell.

## 8.4.1 Network controlled cell reselection completion

The mobile station shall regard the network controlled cell reselection procedure as successfully completed when it has performed access and successfully completed contention resolution in the new cell, or the GMM READY timer (see 3GPP TS 24.008) stops running during the execution of the procedure. The mobile station shall then stop timer T3174.

NOTE 1: Access may be performed for the establishment of a dedicated connection or an uplink TBF.

NOTE 2: If the GMM READY timer stops running, the mobile station shall apply the network controlled cell reselection mode NC0 (i.e., cell re-selection using "normal MS control", see 3GPP TS 45.008).

In case of inter-RAT network controlled cell reselection, the mobile station shall regard the network controlled cell reselection as successfully completed according to specifications of the target RAT, or when the GMM READY timer (see 3GPP TS 24.008) stops running during the execution of the procedure. The mobile station shall then stop timer T3174.

NOTE 3: In case of network controlled cell reselection to UTRAN, the procedure is regarded as successfully completed when the mobile station receives an RRC CONNECTION SETUP message in the target cell (see 3GPP TS 25.331). In case of network controlled cell reselection to E-UTRAN, the procedure is regarded as successfully completed when the mobile station receives an *RRCConnectionSetup* message in the target cell (see 3GPP TS 36.331).

### 8.4.1b (void)

## 8.4.2 Abnormal cases

In the following cases, the mobile station shall determine that the network controlled cell reselection procedure has failed:

- The PACKET CELL CHANGE ORDER message commands the mobile station to a frequency in a frequency band not supported by the mobile station. *Cause*: "frequency not implemented";
- The PACKET CELL CHANGE ORDER message is received while the mobile station is not in dual transfer mode but a circuit switched connection is on going. *Cause*: "on-going CS connection";
- In *A/Gb mode*, the PACKET CELL CHANGE ORDER message is received and the GMM READY timer (see 3GPP TS 24.008) is not running (i.e., mobile station in GMM STAND-BY state). *Cause*, if the GMM READY timer has a negotiated value equal to zero: "Forced to the Standby State". *Cause*, if the GMM READY timer has a negotiated value greater than zero: "MS in GMM Standby state";

- Access is denied in the new cell (i.e., the mobile station receives an IMMEDIATE ASSIGNMENT REJECT, a PACKET ASSIGNMENT REJECT or, in a UTRAN cell, an RRC CONNECTION REJECT message or fails to establish an RRC connection in an E-UTRAN cell as specified in 3GPP TS 36.331). *Cause*: "Immediate Assign Reject or Packet Access Reject on target cell";
- The mobile station is unable to synchronise to the new cell (see 3GPP TS 45.008) or the timer T3174 expires before a successful completion of the network controlled cell reselection procedure. *Cause*: "No response on target cell";
- Due to any other reason (e.g. unknown or unsupported target cell information). In this case the MS shall set the ARFCN and BSIC fields to the value zero and set the cause to value "frequency not implemented".

If the mobile station determines that the network controlled cell reselection procedure has failed, the mobile station shall stop timer T3174 (if it is still running) and start timer T3176. The mobile station shall return to the old cell, where it may trigger a cell update or other GMM specific procedure. In case the mobile station synchronised and attempted to access the new cell before returning to the old cell, the mobile station shall trigger a cell update or other GMM specific procedure, as appropriate according to the GMM requirements (see 3GPP TS 24.008).

The mobile station shall send a PACKET CELL CHANGE FAILURE message with the appropriate cause value to the network in the old cell and stop timer T3176. The PACKET CELL CHANGE FAILURE message may be sent on PACCH when the mobile station is in packet transfer mode or MAC-Shared state. Alternatively, the mobile station may initiate random access with access type "single block without TBF establishment" (PCCCH) / "single block packet access" (CCCH) and send the PACKET CELL CHANGE FAILURE message using an allocated single uplink block.

A mobile station shall ignore a PACKET CELL CHANGE ORDER message received while in dual transfer mode (refer to in 3GPP TS 44.018).

If a MS which is UTRAN capable is commanded to a 3G-target cell whose description is in contradiction to the UTRAN capabilities of the mobile station, it shall include the UTRAN FDD target cell or UTRAN TDD Target cell IE in the PACKET CELL CHANGE FAILURE message.

If a mobile station which is E-UTRAN capable is commanded to an E-UTRAN target cell whose description is in contradiction to the E-UTRAN capabilities of the mobile station, it shall include the *E-UTRAN target cell* IE in the PACKET CELL CHANGE FAILURE message.

In case the network controlled cell reselection procedure fails and the MS returns to the old cell, the MS shall delete any stored NC measurement parameters and revert to the broadcast parameters. If individual priorities are indicated in the PACKET CELL CHANGE ORDER message, they shall be deleted.

If the mobile station is unable to synchronise to the old cell (see 3GPP TS 45.008), or if timer T3176 expires, the mobile station shall cancel the sending of the PACKET CELL CHANGE FAILURE message and perform an autonomous cell re-selection.

## 8.5 Measurement Order procedures in Packet Transfer mode

The network may initiate the measurement order procedure by sending a PACKET MEASUREMENT ORDER message on the PACCH to a mobile station in packet transfer mode or in MAC-Shared state. The PACKET MEASUREMENT ORDER message overrides a broadcast PSI5 message.

The PACKET MEASUREMENT ORDER message may also contain the following optional parameters:

- NC Measurement Parameters (NETWORK\_CONTROL\_ORDER; NC\_NON\_DRX\_PERIOD; NC\_REPORTING\_PERIOD\_I; NC\_REPORTING\_PERIOD\_T; NC\_FREQUENCY\_LIST);
- Enhanced measurement reporting.

Upon receipt of the PACKET MEASUREMENT ORDER message, the mobile station shall store the received parameters and obey the NETWORK\_CONTROL\_ORDER as specified in 3GPP TS 45.008 and in sub-clause 5.6.

## 8.6 PACKET CONTROL ACKNOWLEDGEMENT

A PACKET CONTROL ACKNOWLEDGEMENT message shall always be sent in the uplink block specified by the corresponding valid RRB field of a downlink RLC/MAC control block, and not in any other uplink block that may be

allocated to the mobile station. However the transmission of the PACKET CONTROL ACKNOWLEDGEMENT message takes precedence over the transmission of allocated uplink radio blocks or the reception of PCCCH or assigned PDTCH radio blocks. If transmission of the PACKET CONTROL ACKNOWLEDGEMENT message would result in more than the maximum Tx timeslots per TDMA frame allowed by the multislot class, transmission of the highest numbered PDCH(s) shall be omitted.

In dual transfer mode the reception and transmission of assigned TCH radio blocks on dedicated resources takes precedence over the transmission of the PACKET CONTROL ACKNOWLEDGEMENT.

A mobile station in packet transfer mode in a Downlink Dual Carrier configuration or a DLMC configuration shall respond in the uplink radio block indicated by the RRBP field on the same radio frequency channel as the one where the poll was received. A mobile station in dual transfer mode in a Downlink Dual Carrier configuration shall respond in the uplink radio block on the timeslot or the PDCH pair indicated by the RRBP field (see sub-clause 10.4.5) on the uplink radio frequency channel where the dedicated resource is assigned regardless of which downlink radio frequency channel the poll was received on, unless this would prevent the transmission or reception of a TCH radio block on a dedicated resource.

## 8.7 Abnormal cases

### 8.7.0 General

The following abnormal cases apply:

- If the PDCH containing the mobile station's only assigned TAI value is removed, the mobile station shall, if it has at least one ongoing uplink TBF, perform an abnormal release with access retry (see sub-clause 8.7.2, 3GPP TS 44.160), and otherwise shall perform an abnormal release without retry (see sub-clause 8.7.1);
- If the NC Measurement Parameters are sent in more than one instance of the PACKET MEASUREMENT ORDER message, the mobile station shall not obey the measurement order until all instances of the message has been correctly received;
- If the mobile station receives a Timing Advance Index and a Timing Advance Timeslot Number for one direction within a PACKET POWER CONTROL/TIMING ADVANCE message and the corresponding TBF does not exist, the Timing Advance Index and the Timing Advance Timeslot Number for that direction shall be ignored;
- While a TBF is in progress, if a mobile station receives a PACKET UPLINK ASSIGNMENT, MULTIPLE TBF UPLINK ASSIGNMENT, PACKET UPLINK ACK/NACK, PACKET TIMESLOT RECONFIGURE, MULTIPLE TBF TIMESLOT RECONFIGURE or a PACKET CS RELEASE INDICATION message with message escape bit indicating EGPRS (resp. GPRS) contents whereas the current TBF mode is GPRS (resp. EGPRS), the mobile station shall ignore the message;
- While a TBF is in progress, if a mobile station receives a PACKET DOWNLINK ASSIGNMENT message without extension message content related to R99 whereas the current TBF mode is EGPRS, the mobile station shall ignore the message;
- While a TBF is in progress, if a mobile station receives a PACKET DOWNLINK ASSIGNMENT message with extension message content related to R99 whereas the current TBF mode is GPRS, the mobile station shall ignore the EGPRS related information and act as a GPRS MS not supporting EGPRS;
- In Iu mode, if the network receives a PACKET CONTROL ACKNOWLEDGEMENT message with an incorrect timeslot in the TN\_RRBP field for the given radio block, then the message shall be ignored;
- If a mobile station receives a PACKET UPLINK ASSIGNMENT, PACKET DOWNLINK ASSIGNMENT, MULTIPLE TBF UPLINK ASSIGNMENT, MULTIPLE TBF DOWNLINK ASSIGNMENT, PACKET TIMESLOT RECONFIGURE, MULTIPLE TBF TIMESLOT RECONFIGURE or PACKET CS RELEASE INDICATION message that would result in one or more TBFs with FANR activated and one or more TBFs with FANR not activated when considering all concurrent TBFs assigned to that mobile station, the mobile station shall perform an abnormal release with access retry if there is at least one ongoing uplink TBF (see sub-clause 8.7.2), otherwise it shall perform an abnormal release without retry (see sub-clause 8.7.1);

- If a mobile station receives a PACKET UPLINK ASSIGNMENT, PACKET DOWNLINK ASSIGNMENT, PACKET TIMESLOT RECONFIGURE or PACKET CS RELEASE INDICATION message assigning two or more RLC entities operating in the same RLC mode to a TBF, or assigning more RLC entities than the mobile station supports, the mobile station shall perform an abnormal release without retry (see sub-clause 8.7.2);
- If a mobile station receives DTR information including the TN/PDCH-pair field indicating a timeslot or a PDCH-pair which is not assigned to the mobile station as part of TBF (see sub-clause 8.1.8), the mobile station shall perform an abnormal release without retry (see sub-clause 8.7.1);
- If a mobile station receives a PACKET CS RELEASE INDICATION message including an inconsistent RTTI configuration assignment as per the conditions specified in sub-clause 7.1.3.6, the mobile station shall perform an abnormal release with access retry if there is at least one ongoing uplink TBF (see sub-clause 8.7.2), otherwise it shall perform an abnormal release without retry (see sub-clause 8.7.1).

### 8.7.1 Abnormal release without retry

The mobile station shall abort all TBFs on PDCH(s) in progress and report an RLC/MAC failure to upper layers. The mobile station in packet transfer mode or MAC-Shared state shall return to packet idle mode or MAC-Idle state; the mobile station in dual transfer mode or MAC-DTM state shall return to dedicated mode or MAC-Dedicated state. Upon enhanced CS release while in dual transfer mode, on receipt of PACKET CS RELEASE INDICATION message, the mobile station shall abort all TBFs in progress and return to packet idle mode when the RR connection is released. Upon mobile originated or mobile terminated RR connection establishment, on receipt of IMMEDIATE ASSIGNMENT message while in packet transfer mode, the mobile station shall enter dedicated mode. The DRX mode procedures shall be applied as specified in sub-clause 5.5.1.5 and 3GPP TS 44.160.

### 8.7.2 Abnormal release with access retry

The mobile station shall abort all TBFs in progress. The mobile station in packet transfer mode shall return to packet idle mode and initiate the establishment of one or more new uplink TBFs, using the procedures on CCCH or PCCCH, as defined in sub-clause 7.1.

The mobile station in dual transfer mode shall return to dedicated mode and initiate the establishment of one new uplink TBF (if exclusive allocation is used) or one or more new uplink TBFs (if exclusive allocation is not used) using the appropriate DTM procedure on the main DCCH, defined in 3GPP TS 44.018. Upon enhanced CS release, on receipt of PACKET CS RELEASE INDICATION message, the mobile station shall abort all TBFs in progress and return to packet idle mode and initiate the establishment of one or more new uplink TBFs, using the procedures on CCCH or PCCCH when the RR connection is released.

Upon mobile originated or mobile terminated RR connection establishment, on receipt of IMMEDIATE ASSIGNMENT message while in packet transfer mode, the mobile station shall enter dedicated mode and initiate the establishment of one new uplink TBF (if exclusive allocation is used) or more new uplink TBFs (if exclusive allocation is not used) using the appropriate DTM procedure on the main DCCH, as defined in 3GPP TS 44.018.

In case the mobile station fails to establish a new uplink TBF, the mobile station shall report an RLC/MAC failure to upper layers for that TBF. The DRX mode procedures shall be applied, as specified in sub-clause 5.5.1.5.

### 8.7.3 Abnormal release with system information

The mobile station shall abort all of the TBFs indicated in the assignment message containing invalid frequency parameter information and proceed as follows:

- If there are no on-going TBFs it shall immediately return to the BCCH and reread all relevant BCCH and PBCCH information;
- If the mobile station had one ongoing uplink TBF when the abnormal release occurred, the mobile station shall then perform an abnormal release with access retry (see sub-clause 8.7.2 and 3GPP TS 44.160);
- If the mobile station had no ongoing uplink TBFs when the abnormal release occurred, it shall perform an abnormal release without retry (see sub-clause 8.7.1);

- Otherwise, the mobile station shall maintain all its ongoing TBFs that were in progress prior to receiving the assignment message containing invalid frequency parameter information and provide a failure indication to the upper layers associated with the aborted TBFs.

## 8.7.4 Abnormal release with RR connection establishment retry

The mobile station shall abort all TBFs in progress and report an RLC/MAC failure to upper layers. The mobile station in packet transfer mode shall return to the CCCH configuration, enter packet idle mode and initiate the establishment of the RR connection as specified in 3GPP TS 44.018.

# 8.8 Network Assisted Cell Change procedures

## 8.8.1 Neighbour Cell System Information Distribution

A mobile station in packet transfer mode or in MAC-Shared state may receive neighbouring cell system information for GSM neighbouring cells on PACCH. System Information messages are not distributed for 3G neighbouring cells or E-UTRAN neighbouring cells. The neighbouring cell system information is contained in one or more instances of the PACKET NEIGHBOUR CELL DATA message and the mobile station is addressed by its TFI as follows:

- If a PBCCH is allocated in the neighbouring cell, the instances of the message may contain the PSI1, a consistent set of PSI2 and the PSI14 messages;
- If no PBCCH is allocated in the neighbouring cell, the instances of the message may contain the SI3, SI13 and, if available, SI1 messages. If SI1 is broadcast in the target cell, the network shall include the SI1 message as the first SI message contained in the set of PACKET NEIGHBOUR CELL DATA messages, starting from the message with CONTAINER\_INDEX=0.

A mobile station, which receives this information shall, independent of NC mode or CCN mode, store the last received set of the information for at least one cell. The received system information can then be used for initial access when entering the designated neighbour cell.

All instances of the PACKET NEIGHBOUR CELL DATA message form a complete container for a certain neighbour cell. The container is addressed by a container identity (CONTAINER\_ID) in each instance and optionally by the ARFCN for BCCH and the BSIC of the neighbour cell. The CONTAINER\_ID shall then be included in the PACKET CELL CHANGE CONTINUE or the PACKET CELL CHANGE ORDER message together with the ARFCN and the BSIC. This is in order to map the cell identity to the container identity for which neighbour cell information was received in the PACKET NEIGHBOUR CELL DATA messages. If the ARFCN and BSIC are given for a set of PACKET NEIGHBOUR CELL DATA messages, it is sufficient to include this information in only one instance in the set.

In order to ensure a consistent distribution and decoding of (P)SI messages contained in PACKET NEIGHBOUR CELL DATA messages, the following rules shall apply for PACKET NEIGHBOUR CELL DATA messages with the same container identity:

- Whenever the network starts sending a set of PACKET NEIGHBOUR CELL DATA message instances, the first PACKET NEIGHBOUR CELL DATA message instance shall be started with CONTAINER\_INDEX=0;
- All subsequent instances of a PACKET NEIGHBOUR CELL DATA message set shall be sent in ascending order of CONTAINER\_INDEX value. For retransmission purposes it is allowed to send a PACKET NEIGHBOUR CELL DATA message with the same CONTAINER\_INDEX value and the same content more than once;
- Whenever the MS receives a PACKET NEIGHBOUR CELL DATA message instance with CONTAINER\_INDEX=0 or with a CONTAINER\_INDEX value that is less than the CONTAINER\_INDEX value of the last received PACKET NEIGHBOUR CELL DATA message instance, it shall delete any PACKET NEIGHBOUR CELL DATA message instances it may have stored and the extracted system information of the neighbour cell;
- If the MS receives a PACKET NEIGHBOUR CELL DATA message with a different ARFCN and BSIC than was indicated in one or more already received PACKET NEIGHBOUR CELL DATA message instances, it shall

delete any PACKET NEIGHBOUR CELL DATA message instances it may have stored and the extracted system information of the neighbour cell;

- 30 s after the reception of the latest PACKET NEIGHBOUR CELL DATA message instance, the MS shall delete any PACKET NEIGHBOUR CELL DATA message instances it may have stored the extracted system information of the neighbour cell.

When the mobile station receives the PACKET CELL CHANGE ORDER or the PACKET CELL CHANGE CONTINUE message the mobile station shall transmit a PACKET CONTROL ACKNOWLEDGMENT message in the specified uplink radio block if a valid RRBP field is received as part of the message; the mobile station may then switch to a new cell. If the mobile station has collected all required instances of the PACKET NEIGHBOUR CELL DATA message for the new cell already when in the old cell, then it may perform access depending on whether the PACKET PSI STATUS (or PACKET SI STATUS if PBCCH is not supported in the new cell) procedures are supported by the network in the new cell (see below). The required instances of the PACKET NEIGHBOUR CELL DATA message include PSI1, a consistent set of PSI2 messages and PSI14 (if the new cell has a PBCCH allocated) or SI3, SI13 and, if available, SI1 messages (if the new cell does not have a PBCCH allocated). If the MS is able to decode the first SI message contained in the set of PACKET NEIGHBOUR CELL DATA messages but it was not the SI1 message, the MS shall conclude that SI1 is not broadcast in that particular cell in determining when packet access is allowed in the cell (see sub-clause 5.5.1.3).

If not all required instances of the PACKET NEIGHBOUR CELL DATA message have been received before the cell change, the MS shall first obtain the PBCCH description (if available) and the missing system information messages before making initial access in the new cell. However, it may switch to the new cell as soon as PSI1 has been received (if PBCCH is supported in the new cell) or SI13 has been received (if PBCCH is not supported in the new cell).

Once all the required system information messages have been received, and if the new cell supports the PACKET PSI STATUS (respectively PACKET SI STATUS) procedures, the mobile station may perform access in the new cell and shall then use these procedures for acquisition of PSI (respectively SI) messages (see sub-clause 5.5.1.4.3). If the PACKET PSI STATUS (respectively PACKET SI STATUS) procedures are not supported by the network in the new cell, then the MS is still required to make at least one attempt to receive the complete set of PSI messages on PBCCH (respectively make at least one attempt to receive other SI messages that may be scheduled within one TC cycle on BCCH) prior to perform access in the new cell (see sub-clauses 5.5.1.2 and 5.5.1.3 and 3GPP TS 44.160).

## 8.8.2 CCN setting procedure

The network uses the parameter CCN\_ACTIVE in the GPRS Cell Options IE on the BCCH (SI13) or PBCCH (PSI1/PSI13/PSI14) to indicate in the cell whether CCN is enabled for cell reselection towards GSM cells.

The network uses the parameter 3G\_CCN\_ACTIVE on the BCCH (SI2quater) or PBCCH (PSI3quater) to indicate in the cell whether CCN is enabled for cell reselection towards 3G cells (including UTRAN CSG cells).

The network uses the parameter E-UTRAN\_CCN\_ACTIVE on the BCCH (SI2quater) to indicate in the cell whether CCN is enabled for cell reselection towards E-UTRAN cells (including E-UTRAN CSG cells).

- If CCN\_ACTIVE is not provided or it indicates that CCN is disabled in the cell, the mobile stations shall not follow the CCN procedures towards GSM cells. CCN\_ACTIVE can also be individually sent to the mobile station in either a PACKET MEASUREMENT ORDER, a PACKET CELL CHANGE ORDER message or a PS HANDOVER COMMAND message. In the latter cases, the setting applies in the target cell;
- If 3G\_CCN\_ACTIVE is not provided or it indicates that CCN is disabled in the cell, the mobile stations shall not follow the CCN procedures towards 3G cells. 3G\_CCN\_ACTIVE can also be individually sent to the mobile station in either a PACKET MEASUREMENT ORDER, a PACKET CELL CHANGE ORDER message or a PS HANDOVER COMMAND. In the latter cases, the setting applies in the target cell;
- If E-UTRAN\_CCN\_ACTIVE is not provided or it indicates that CCN is disabled in the cell, the mobile station shall not follow the CCN procedures towards E-UTRAN cells. E-UTRAN\_CCN\_ACTIVE can also be individually sent to the mobile station in either a PACKET MEASUREMENT ORDER, a PACKET CELL CHANGE ORDER message or a PS HANDOVER COMMAND. In the latter cases, the setting applies in the target cell;
- If CCN\_ACTIVE indicates that CCN is enabled in the cell and a mobile station determines a cell re-selection towards one of its neighbouring GSM cells is required, it shall first check the corresponding CCN\_SUPPORTED

parameter if available. This allows the network to enable CCN mode towards some but not all neighbour GSM cells.

NOTE: It is not possible for the network to enable CCN mode towards individual 3G or E-UTRAN neighbour cells.

An individual setting of CCN shall take precedence over the broadcast setting of CCN. The latest individual ordered setting of CCN is the valid one. An individual setting of CCN is only valid within the cell it is ordered for. CCN is applicable to a mobile station in Network Control mode NC0 and NC1 but not in mode NC2 that takes precedence over CCN.

## 8.8.2a CCN support description

The CCN Support description contains the CCN\_SUPPORTED parameter for each GSM cell of the GSM Neighbour Cell list.

If there is no PBCCH allocated in the cell, see 3GPP TS 44.018.

If there is a PBCCH allocated in the cell, the parameter can be provided in the PSI3 message or any instance of the PSI3bis message. In that case, the bitmap applies to the GSM Neighbour Cell list having the same PSI3\_CHANGE\_MARK as the message in which it is provided.

CCN\_SUPPORTED parameter can also be provided in a PACKET CELL CHANGE ORDER or a PACKET MEASUREMENT ORDER message. In this case, the bitmap applies to the updated GSM Neighbour Cell list.

Each CCN\_SUPPORTED bit of this description relates to indices of the GSM Neighbour Cell list, starting with index 0. The CCN Support description may be received before the corresponding GSM Neighbour Cell list.

Indices exceeding the value 95 or the number of cells in the GSM Neighbour Cell list (whichever is the lowest) shall be ignored. If there are fewer indices than the number of cells in the GSM Neighbour Cell list, the value 0 shall be assumed for the missing bits.

When this information is not present but CCN is enabled in the serving cell, the mobile station shall assume that CCN is enabled towards all neighbour cells.

## 8.8.3 Cell Change Notification procedure

If CCN is enabled towards the target cell (see sub-clause 5.5.1.1a and 3GPP TS 44.160), the mobile station shall behave as in network control mode NC0 or NC1 up to the point when a new cell has been chosen. If the target cell is a GSM cell, the mobile station shall then check the CCN\_SUPPORTED parameter, if available, that was last received for that cell. This parameter can be sent on BCCH or PBCCH or individually in PACKET MEASUREMENT ORDER or PACKET CELL CHANGE ORDER or PS HANDOVER COMMAND messages.

If for a GSM cell the CCN\_SUPPORTED parameter is available and if it indicates that CCN mode shall not be entered towards that cell, then the mobile station shall perform the cell change and not enter CCN mode. If the cell reselection is triggered by the path loss criterion parameter C1 becoming negative, the mobile station may perform the cell change without entering the CCN mode.

If the target cell is a GSM cell and the CCN\_SUPPORTED parameter is available and if it indicates that CCN mode shall be entered towards that cell or if the CCN\_SUPPORTED parameter is not available, then instead of performing the cell change, the mobile station shall start timer T3206 and enter the CCN mode. At the first possible opportunity, the MS shall then, when in CCN mode, inform the network about the proposed target cell by sending a PACKET CELL CHANGE NOTIFICATION message, stop timer T3206, start timers T3208 and T3210.

If the target cell is a 3G cell and if CCN is activated towards 3G cells or if the target cell is an E-UTRAN cell and the mobile station supports "CCN towards E-UTRAN, E-UTRAN Neighbour Cell measurement reporting and Network controlled cell reselection to E-UTRAN" and if CCN is activated towards E-UTRAN cells, then instead of performing the cell change, the mobile station shall start timer T3206 and enter the CCN mode. At the first possible opportunity, the MS shall then, when in CCN mode, inform the network about the proposed target cell by sending a PACKET CELL CHANGE NOTIFICATION message, stop timer T3206, start timers T3208 and T3210.

If the target cell is a GAN cell and the CCN\_SUPPORTED parameter is available and if it indicates that CCN mode shall be entered towards that cell or if the CCN\_SUPPORTED parameter is not available, then instead of performing



the cell change, the mobile station shall start timer T3206 and enter the CCN mode. At the first possible opportunity, a mobile station may, when in CCN mode, send a PACKET CELL CHANGE NOTIFICATION message that includes the ARFCN/BSIC for the GAN cell and indicates an RXLEV of 63 for the GAN cell and start timers T3208 and T3210.

The PACKET CELL CHANGE NOTIFICATION message shall contain the identity of the proposed target cell. A GSM cell shall be identified by the ARFCN for the BCCH and the BSIC. A 3G-FDD cell shall be identified by FDD\_ARFCN, Bandwidth\_FDD and Scrambling Code. A 3G-TDD cell shall be identified by TDD\_ARFCN, Bandwidth\_TDD, Cell parameter and Sync Case. An E-UTRAN cell shall be identified by EARFCN, Measurement Bandwidth and Physical Layer Cell Identity.

The PACKET CELL CHANGE NOTIFICATION message shall also contain measurement reports for the proposed cell and for six other (see 3GPP TS 45.008) neighbour cells, if available. If 3G Neighbour cells are reported, the type of report for FDD cells are specified by the FDD\_REP\_QUANT parameter and the number of 3G reports in the message are specified by the parameters FDD\_MULTIRAT\_REPORTING and TDD\_MULTIRAT\_REPORTING. These parameters may either be broadcast on BCCH or PBCCH or sent to the mobile station in a PACKET MEASUREMENT ORDER or PACKET CELL CHANGE ORDER message. If E-UTRAN Neighbour cells are reported, the type of report is specified by the E-UTRAN\_REP\_QUANT parameter and the maximum number of E-UTRAN reports in the message is specified by the parameter E-UTRAN\_MULTIRAT\_REPORTING. These parameters may either be broadcast on BCCH or sent to the mobile station in a PACKET MEASUREMENT ORDER message.

When a multi-RAT MS attempts cell change to a UTRAN (respectively E-UTRAN) CSG cell or a detected hybrid cell if the cell's CSG ID is included in the CSG Whitelist of the MS and CCN procedures are used, if the *CSG Cells Reporting Description* IE has been received from the network and the mobile station supports CSG Cells Reporting, the mobile station shall include in the PACKET CELL CHANGE NOTIFICATION message the CSG-ID and the routing parameters of the target cell. In this case, if a cell change failure occurs, the subsequent transmission of a PACKET CELL CHANGE FAILURE message shall contain the routing parameters of the target cell.

In CCN mode the mobile station shall continue the data transfer and store neighbour cell system information if received in instances of the PACKET NEIGHBOUR CELL DATA message, but not perform the cell change. At receipt of the first PACKET NEIGHBOUR CELL DATA message or PACKET CELL CHANGE CONTINUE message or PACKET CELL CHANGE ORDER message or PS HANDOVER COMMAND message, the mobile station shall stop the timer T3210.

The mobile station shall retransmit the PACKET CELL CHANGE NOTIFICATION message once at the first possible opportunity when the timer T3210 expires.

The mobile station shall leave CCN mode when either CCN is no longer enabled (towards all GSM, 3G or E-UTRAN neighbour cells with the CCN\_ACTIVE/3G\_CCN\_ACTIVE/E-UTRAN\_CCN\_ACTIVE bit or towards the cell that had been re-selected) or when the network has responded with a PACKET CELL CHANGE CONTINUE or PACKET CELL CHANGE ORDER message or a PS HANDOVER COMMAND message or when either of the timers T3206 or T3208 have expired.

If the mobile station has been individually ordered to enable CCN, the order is only valid within the cell where the order is given. When a cell change has been performed using the cell reselection procedure, the mobile station shall use CCN in the new cell only if individually ordered in the previous cell with the PACKET CELL CHANGE ORDER message or if individually ordered or broadcast in the new cell. When a cell change has been performed using the PS handover procedure, the mobile station shall enable CCN in the new cell only if individually ordered in the previous cell with the PS HANDOVER COMMAND message or if individually ordered or broadcast in the new cell.

After receiving a PACKET CELL CHANGE NOTIFICATION message from the mobile station the network can behave in different ways as described below:

- 1) The network responds with a PACKET CELL CHANGE CONTINUE message.  
If a mobile station as response to a PACKET CELL CHANGE NOTIFICATION message receives a PACKET CELL CHANGE CONTINUE message without receiving any neighbour cell system information, the mobile station shall stop timer T3208, stop timer T3210 if still running, leave CCN mode and continue cell reselection in NC0/NC1 mode.
- 2) The network sends first necessary system information for the cell proposed in the PACKET CELL CHANGE NOTIFICATION message if the proposed target cell is a GSM cell in one or more instances of the PACKET NEIGHBOUR CELL DATA message and sends then a PACKET CELL CHANGE CONTINUE message.  
The mobile station shall store the received system information as specified in sub-clause 8.8.1. When the first instance of the PACKET NEIGHBOUR CELL DATA message is received, the mobile station shall stop timer T3210 if still running. When the PACKET CELL CHANGE CONTINUE message is received, the mobile

station shall stop timer T3208, leave CCN mode and continue the cell reselection in NC0/NC1 mode irrespective of the cell indicated in the ARFCN and BSIC parameters in the PACKET CELL CHANGE CONTINUE message.

- 3) The network sends first necessary system information for the cell proposed in the PACKET CELL CHANGE NOTIFICATION message if the proposed target cell is a GSM cell, or for any other GSM cell, in one or more instances of the PACKET NEIGHBOUR CELL DATA message and sends then a PACKET CELL CHANGE ORDER message or a PS HANDOVER COMMAND message.

The mobile station shall store the received system information as specified in sub-clause 8.8.1. When the first instance of the PACKET NEIGHBOUR CELL DATA message is received, the mobile station shall stop timer T3210 if still running. When the PACKET CELL CHANGE ORDER message is received, the mobile station shall stop timer T3208, leave CCN mode and follow the procedures as specified for the PACKET CELL CHANGE ORDER message (sub-clause 8.4) and in sub-clause 8.8.1. When the PS HANDOVER COMMAND message is received, the mobile station shall stop timer T3208, leave CCN mode and follow the procedures as specified for the PS HANDOVER COMMAND message in sub-clause 8.10.4.

- 4) The network orders the mobile station into NC2 mode.  
A mobile station may in response to a PACKET CELL CHANGE NOTIFICATION message receive a PACKET MEASUREMENT ORDER message from the network indicating NC2 mode. When the mobile station receives the NC2 order it shall leave CCN mode, stop timer T3208, stop timer T3210 if still running, and go into NC2 mode.

When the NC2 mode has been ordered, the network may send PACKET NEIGHBOUR CELL DATA messages on the PACCH before sending the PACKET CELL CHANGE ORDER message to the mobile station. When the NC2 mode has been ordered, the network shall send PACKET NEIGHBOUR CELL DATA messages on the PACCH before sending the PS HANDOVER COMMAND message (see sub-clause 8.10.2) to the mobile station except if these messages are not needed by the mobile station (i.e. for the case of PS handover to a GAN cell).

- 5) No network response  
When timer T3210 expires, the mobile station shall retransmit once the PACKET CELL CHANGE NOTIFICATION message at the first possible opportunity.  
When timer T3208 expires, the mobile station shall leave CCN mode and continue cell reselection in NC0/NC1 mode as described in sub-clause 5.5.1.1 and 3GPP TS 44.160 and in 3GPP TS 45.008.

The CCN mode is only valid in packet transfer mode or in MAC-Shared state. If the mobile station is in CCN mode when entering packet idle mode or MAC-Idle state, the mobile station shall stop the timers T3206 and T3208, stop timer T3210 if still running, leave CCN mode and continue the cell reselection procedure according to the NC0/NC1 procedures. If PACKET NEIGHBOUR CELL DATA messages are received on the PACCH before entering packet idle mode or MAC-Idle state and the cell identity parameters are included, this information may then be used at the next cell change.

If the cell reselection criteria have changed during the time the MS is in CCN mode but the path loss criterion parameter C1 remains positive, the MS shall, without notifying the network about the new preferred cell, remain in CCN mode until the criteria for CCN mode are no longer fulfilled. When leaving CCN mode the MS shall obey the new criteria according to the normal rules as specified in sub-clause 5.5.1.1 and 3GPP TS 44.160 and in 3GPP TS 45.008 unless a PACKET CELL CHANGE ORDER or a PS HANDOVER COMMAND message has been received (see bullet 3 above). If the path loss criterion parameter C1 becomes negative while the MS is in CCN mode, the MS may leave the CCN mode without notifying the network and perform the cell change.

## 8.9 RR connection establishment in packet transfer mode

### 8.9.0 General

The initiation of the procedure and the assignment of resources for the establishment of the RR connection are described in sub-clauses 8.9.1 and 8.9.2, respectively.

The establishment of the main signalling link and the completion of the establishment of the RR connection are described in 3GPP TS 44.018.

## 8.9.1 Initiation

### 8.9.1.1 Initiation by the mobile station

#### 8.9.1.1.1 Transmission of the PACKET CS REQUEST message

The RR connection establishment procedure is initiated by the RR entity of the mobile station. Initiation is triggered by request from the MM sublayer to enter dual transfer mode. The request from the MM sublayer to establish the RR connection specifies an establishment cause.

The RR entity in the mobile station shall not request the establishment of an RR connection while in packet transfer mode from the point where it receives a PS HANDOVER COMMAND message until the PS handover procedure has been completed (see sub-clause 8.10).

On receipt of the RR connection establishment request from upper layer the mobile station shall start timer T3196. At expiry of timer T3196, the mobile station shall release all ongoing TBFs and start RR connection establishment as specified in 3GPP TS 44.018. If a mobile station that supports PS handover receives a PS HANDOVER COMMAND message while T3196 is running it shall stop T3196, abort its current attempt to establish an RR connection and not make another attempt to establish an RR connection until completion of the PS handover procedure.

If the contention resolution is not solved, the mobile station shall delay the transmission of the PACKET CS REQUEST message until contention resolution is solved.

If the countdown procedure has been started on all the ongoing uplink TBFs, none of those TBFs is operating in extended uplink TBF mode and there is no downlink TBF in progress, the mobile station may either send the PACKET CS REQUEST message, or may immediately release the ongoing TBF(s) and start an RR connection establishment as specified in 3GPP TS 44.018.

The mobile station shall initiate the RR connection establishment by sending PACKET CS REQUEST messages on the PACCH. The mobile station is allowed to retransmit the PACKET CS REQUEST message once while timer T3196 is running. The second sending occurrence of this message shall take place at the first suitable opportunity at least 0.75 s after the first transmission of that message.

#### 8.9.1.1.2 Answer from the network

Upon receipt of a PACKET CS REQUEST message, the network shall answer to the mobile station by encapsulating one of the following RR messages in the PACKET CS COMMAND message, and sending the PACKET CS COMMAND message on PACCH:

- DTM ASSIGNMENT COMMAND message (see sub-clause 8.9.2.1); or
- IMMEDIATE ASSIGNMENT message (see sub-clause 8.9.2.2); or
- IMMEDIATE ASSIGNMENT REJECT message (see sub-clause 8.9.2.3).

Upon receipt of PACKET CS COMMAND message encapsulating one of the above messages the mobile station shall stop timer T3196.

### 8.9.1.2 Initiation by the network

The network initiates the RR connection establishment procedure by sending a PACKET CS COMMAND message to the mobile station on PACCH, encapsulating one of the following RR messages:

- DTM ASSIGNMENT COMMAND message (see sub-clause 8.9.2.1); or
- IMMEDIATE ASSIGNMENT message (see sub-clause 8.9.2.2).

After sending the mobile station a PS HANDOVER COMMAND message the network shall not initiate the establishment of an RR connection for that mobile station until the PS handover procedure has been completed (see sub-clause 8.10).

## 8.9.2 Assignment

### 8.9.2.1 Assignment of both dedicated and packet resource

The network may allocate both a dedicated channel and radio resources on one or more PDCHs to be used by the mobile station and shall in this case send a DTM ASSIGNMENT COMMAND encapsulated in a PACKET CS COMMAND message. Having sent the DTM ASSIGNMENT COMMAND message, the network starts timer T3107, specified in 3GPP TS 44.018. The allocated dedicated channel shall be of TCH type. The network may also reallocate radio resources (PDCH(s)) in the DTM ASSIGNMENT COMMAND message. If both the RR Packet Uplink Assignment and the RR Packet Downlink Assignment information elements are omitted in the DTM ASSIGNMENT COMMAND the network implicitly indicates that the current radio resources shall be maintained. The mobile station shall act on the DTM ASSIGNMENT COMMAND message as specified in 3GPP TS 44.018.

On receiving an encapsulated DTM ASSIGNMENT COMMAND message, the mobile station shall establish the main signalling link using the procedure described in 3GPP TS 44.018.

The completion of the establishment of the RR connection is described in 3GPP TS 44.018.

If timer T3107 elapses before the successful establishment of the main signalling link on the new channel, both the new CS channel and new PS resources are released. If the encapsulated DTM ASSIGNMENT COMMAND message was sent in response to a PACKET CS REQUEST message received from the mobile, then the old PS resources are also released.

NOTE: If timer T3107 expires and the procedure was initiated by the network, the subsequent network behaviour with respect to the old PS resources is implementation dependent.

### 8.9.2.2 Assignment of dedicated resource only

The network may allocate only a dedicated channel to the mobile station and shall in this case send an IMMEDIATE ASSIGNMENT encapsulated in a PACKET CS COMMAND message. Having sent the IMMEDIATE ASSIGNMENT message, the network starts timer T3101, specified in 3GPP TS 44.018.

If a mobile station receives an encapsulated IMMEDIATE ASSIGNMENT message which either does not specify a starting time or specifies a starting time which has already elapsed, the mobile station shall immediately:

- perform an abnormal release without retry (see sub-clause 8.7.1), if no uplink TBF is in progress, or,
- perform an abnormal release with access retry (see sub-clause 8.7.2), if one or more uplink TBFs are in progress.

On receiving an encapsulated IMMEDIATE ASSIGNMENT message which specifies a starting time which has not yet elapsed, the mobile station shall wait until the specified start time. If, at that time, no uplink TBF is in progress, the mobile station shall perform an abnormal release without retry (see sub-clause 8.7.1); else (i.e. one or more uplink TBFs are in progress) the mobile station shall perform an abnormal release with access retry (see sub-clause 8.7.2).

The mobile station shall proceed with the assignment by establishing the main signalling link using the procedure described in 3GPP TS 44.018. In respect of the RR connection, the mobile station shall act on the starting time information element, if present, as specified in 3GPP TS 44.018.

The completion of the establishment of the RR connection is described in 3GPP TS 44.018.

If timer T3101 elapses before the main signalling link is established, the new CS channel is released. If the encapsulated IMMEDIATE ASSIGNMENT message was sent in response to a PACKET CS REQUEST message received from the mobile, the old PS resources are also released.

NOTE: If timer T3101 expires and the procedure was initiated by the network, the subsequent network behaviour with respect to the old PS resources is implementation dependent.

### 8.9.2.3 Rejection of the mobile station request

If no dedicated channel is available for assignment, the network may send to the mobile station an IMMEDIATE ASSIGNMENT REJECT message encapsulated in a PACKET CS COMMAND message.

On receipt of the encapsulated IMMEDIATE ASSIGNMENT REJECT message the mobile station shall stop sending PACKET CS REQUEST messages, starts timer T3122 with the indicated value ("wait indication" information element, specified in 3GPP TS 44.018) and continue in packet transfer mode.

The behaviour of the mobile station while timer T3122 is running is specified in 3GPP TS 44.018.

### 8.9.3 (void)

## 8.9.4 Abnormal cases

### 8.9.4.1 RR connection establishment initiated by the mobile station

If a failure occurs on the mobile station side before the successful establishment of the main signalling link, the allocated channels are released; the subsequent behaviour of the mobile station depends on the type of failure and previous actions:

- If the radio resources have been dropped before the network has a chance to respond to the PACKET CS REQUEST, the network shall abort the current DTM procedure.
- If the mobile station does not receive the PACKET CS COMMAND message after it has sent a corresponding PACKET CS REQUEST message (i.e. expiry of timer T3196), the mobile station shall perform an abnormal release with the RR connection establishment retry (see sub-clause 8.7.4).
- If the mobile station receives the DTM ASSIGNMENT COMMAND or the IMMEDIATE ASSIGNMENT message specifying frequencies that are not all in one frequency band then the mobile station shall perform an abnormal release with RR connection establishment retry (see sub-clause 8.7.4).
- If the mobile station receives the DTM ASSIGNMENT COMMAND or the IMMEDIATE ASSIGNMENT message specifying a frequency that is in a frequency band not supported by the mobile station then the mobile station shall perform an abnormal release with RR connection establishment retry (see sub-clause 8.7.4).
- If the information in the DTM ASSIGNMENT COMMAND message does not properly specify an uplink PDCH or specifies a multislot configuration that the mobile station does not support (see 3GPP TS 45.002), the mobile station shall perform an abnormal release with RR connection establishment retry (see sub-clause 8.7.4).
- If the information in the DTM ASSIGNMENT COMMAND message does not properly specify an uplink and downlink PDCH or specifies a multislot configuration that the mobile station does not support (see 3GPP TS 45.002), the mobile station shall perform an abnormal release with RR connection establishment retry (see sub-clause 8.7.4).
- If a failure in the assignment message (e.g. DTM ASSIGNMENT COMMAND or the IMMEDIATE ASSIGNMENT message) is due to any other reason, the mobile station shall perform an abnormal release with RR connection establishment retry (see sub-clause 8.7.4).
- If the mobile fails to establish the main signalling link, it shall perform an abnormal release with RR connection establishment retry (see sub-clause 8.7.4).

### 8.9.4.2 RR connection establishment initiated by the network

If a failure occurs on the mobile station side before the successful establishment of the main signalling link, the allocated channels are released; the subsequent behaviour of the mobile station depends on the type of failure and previous actions:

- If the information in the DTM ASSIGNMENT COMMAND message does not properly specify an uplink PDCH or specifies a multislot configuration that the mobile station does not support (see 3GPP TS 45.002), the mobile station shall perform an abnormal release with access retry (see sub-clause 8.7.2).
- If the information in the DTM ASSIGNMENT COMMAND message does not properly specify an uplink and downlink PDCH, the mobile station shall perform an abnormal release with access retry (see sub-clause 8.7.2).

- If the mobile station has been reassigned a TBF in EGPRS TBF mode and the MS does not support EGPRS, or has been reassigned an MCS (e.g. 8-PSK in the uplink) that the MS does not support, the MS shall enter to dedicated mode and notify higher layers (TBF establishment failure).
- On expiry of timer T3190, the mobile station shall enter dedicated mode.
- If a failure in the DTM ASSIGNMENT COMMAND message is due to any other reason, the mobile station shall return to packet idle mode.
- If there is a failure in the IMMEDIATE ASSIGNMENT message the mobile station shall continue in packet transfer mode.
- If the mobile fails to establish the main signalling link, it shall perform an abnormal release with RR connection establishment retry (see sub-clause 8.7.4).

## 8.10 Packet Switched Handover procedure

### 8.10.1 General

This procedure is only applicable in packet transfer mode when both the mobile station and the network support PS handover. The support of PS handover procedures requires the support of PFC procedures in both the network and the mobile station. In packet transfer mode, a mobile station that supports PS handover may receive a PS HANDOVER COMMAND message from the BSS indicating the resources to be used in the new cell.

The support of the PS handover procedures is optional for the mobile station and the network and is indicated in the *MS Radio Access Capability* IE. For an E-UTRAN capable multi-RAT mobile station, the support of PS handover to E-UTRAN is indicated in the "GERAN to E-UTRAN support in GERAN packet transfer mode" field within the *MS Radio Access Capability* IE (see 3GPP TS 24.008). A mobile station supporting the PS handover procedures shall also support the extended RLC/MAC control message segmentation as defined in 9.1.12a.

### 8.10.2 Neighbour Cell System Information Distribution

For the case of PS handover from *A/Gb mode* to *A/Gb mode* the network shall send the mobile station PACKET NEIGHBOUR CELL DATA messages containing PSI messages (PBCCH allocated in new cell) or SI messages (PBCCH not allocated in new cell) corresponding to the new cell prior to sending it the PS HANDOVER COMMAND message directing it to that cell. PACKET NEIGHBOUR CELL DATA messages are received on PACCH as described in sub-clause 8.8.1. The minimum set of SI and PSI messages to be sent in PACKET NEIGHBOUR CELL DATA messages is as follows:

- If PBCCH is not allocated in the new cell then SI3, SI1 (if present in the new cell) and SI13 shall be sent.
- If PBCCH is allocated in the new cell then PSI1, a consistent set of PSI2 messages and PSI14 shall be sent.

For the case of PS handover from *Iu mode* to *A/Gb mode* or from *GAN mode* to *A/Gb mode* or from E-UTRAN to *A/Gb mode* the network shall send the mobile station the same set of PSI messages or SI messages corresponding to the new cell as for the case of PS handover from *A/Gb mode* to *A/Gb mode*. In this case the network sends the mobile station the system information corresponding to the new cell within the Handover from UTRAN Command message as described in 3GPP TS 25.331 and 3GPP TS 44.118 for the case of PS handover from *Iu mode* to *A/Gb mode* or within the GA-PSR HANDOVER COMMAND message as described in 3GPP TS 44.318 [42] for the case of PS handover from *GAN mode* to *A/Gb mode* or within the *MobilityFromEUTRACommand* message as described in 3GPP TS 36.331 [45] for the case of PS handover from *E-UTRAN* to *A/Gb mode*.

For the case of PS handover from *A/Gb mode* to *Iu mode* or from *A/Gb mode* to *GAN mode* or from *A/Gb mode* to E-UTRAN, system information corresponding to the new cell is sent to the mobile station in the new cell as described in 3GPP TS 25.331 and 3GPP TS 44.118 for PS handover to *Iu mode* or as described in 3GPP TS 44.318 [42] for PS handover to *GAN mode* or as described in 3GPP TS 36.331 [45] for PS handover to E-UTRAN.

## 8.10.3 PS Handover at the network side

### 8.10.3.1 Initiation of PS Handover Procedure

The source BSS may initiate the PS handover procedure as a result of various trigger conditions such as, but not restricted to, the following:

- Upon receiving a measurement report or a PACKET CELL CHANGE NOTIFICATION message from a mobile station operating in *A/Gb mode*.
- Upon determining that resource limitations exist for the serving cell.
- Upon receiving the *Service UTRAN CCO* IE from the SGSN indicating that a mobile station operating in *A/Gb mode* would be better served in a cell supporting a different RAT.

If the mobile station is not already in NC2 then the source BSS may order the mobile station to enter NC2 before initiating the PS handover procedure. For the normal case of PS handover the target RNC/BSS/GANC/eNB receives a network request to allocate resources required to perform a PS handover. For the optimized case of PS handover (applicable only for *A/Gb mode* to *A/Gb mode* PS handover - see 3GPP TS 43.129) an SGSN request for the BSS to allocate resources is not required as the resources required to perform a PS handover are allocated autonomously by the BSS (i.e. without SGSN involvement).

### 8.10.3.2 A/Gb to A/Gb PS Handover

For both the normal and optimized cases of PS handover from *A/Gb mode* to *A/Gb mode* the (source) BSS shall impose the following restrictions on RLC/MAC control plane corresponding to a mobile station for which the PS handover procedure is ongoing:

- All mobile station requests to establish new uplink TBFs shall be ignored and no new downlink TBFs shall be established.
- The PS HANDOVER COMMAND message shall be sent using extended RLC/MAC control message segmentation (see sub-clause 9.1.12a) if three or more RLC/MAC control blocks are required to send the complete message.

After sending the PS HANDOVER COMMAND to the MS, the source BSS shall continue to schedule opportunities for the mobile station to transmit an RLC/MAC control message, either by means of an existing uplink TBF, or by means of polling using an existing downlink TBF, for a period of time sufficiently long to allow the mobile station to transmit a PACKET CELL CHANGE FAILURE message (should a PS handover failure occur). During this period, the BSS may allocate fewer transmission opportunities than would otherwise be required according to the QoS requirements of the ongoing PFCs. No TBFs shall be released during this period except on receipt of a DELETE-BSS-PFC PDU from the SGSN.

For both the normal and optimized cases of PS handover from *A/Gb mode* to *A/Gb mode* the (target) BSS creates a complete PS HANDOVER COMMAND message that is sent to the mobile station in the old cell:

For the normal case of PS handover the source BSS shall send the Page Mode, Global TFI and Container ID information elements to the target BSS which uses them to create a complete PS HANDOVER COMMAND message (see sub-clause 11.2.43).

For the normal case of PS handover the source BSS receives a complete PS HANDOVER COMMAND message from the target BSS (passed through the SGSN) and then sends it to the mobile station. For the optimized case of PS handover the BSS creates a complete PS HANDOVER COMMAND message and sends it directly to the mobile station.

If the PS HANDOVER COMMAND indicates RLC reset for a TBF allocated in the new cell corresponding to the PFC(s) receiving a PS handover, the target BSS shall initialize one or more new RLC entities to support that TBF. Otherwise, the TBF allocated in the new cell shall be supported using the same set of RLC entities used to support the TBF in the old cell corresponding to the same PFC(s) (i.e. the RLC state machine is maintained across PS handover).

The PS HANDOVER COMMAND message created by the target BSS shall always allocate resources for at least one uplink TBF to ensure that the mobile station can send PS HANDOVER ACCESS messages (if required) and one or

more RLC data blocks in the new cell. When only one uplink TBF is allocated by the PS HANDOVER COMMAND message and does not correspond to a PFC, RLC acknowledged mode shall be used.

The PS HANDOVER COMMAND message shall include the PS Handover Radio Resources Info IE if the allocated resources are not required to support any of the features Downlink Dual Carrier, Downlink Multi Carrier, EGPRS2, Fast Ack/Nack Reporting or RTTI configurations. If the allocated resources are required to support Downlink Multi Carrier the network shall include the *PS Handover Radio Resources 3* IE in the PS HANDOVER COMMAND message. Otherwise, the network shall include the PS Handover Radio Resources 2 Info IE in the PS HANDOVER COMMAND message.

The PS HANDOVER COMMAND message created by the target BSS shall indicate the PS Handover type with the synchronization indication field, i.e. non-synchronized, synchronized or pre-synchronized PS handover.

The PS HANDOVER COMMAND shall contain the PFI for each TBF being set up if and only if both the network and the mobile station support multiple TBFs. A mobile station which receives a PS HANDOVER COMMAND and which does not support multiple TBFs shall ignore any PFI value(s) received in the PS HANDOVER COMMAND. The target BSS expects one or more PS HANDOVER ACCESS messages from the mobile station whenever Handover Reference information is included in the PS HANDOVER COMMAND message. Handover Reference information shall always be included whenever non-synchronized PS handover is used.

Depending on the type of handover the target BSS shall proceed as follows:

- In case of a synchronized or pre-synchronized PS handover the target BSS shall enable the reception of RLC data blocks on all uplink TBFs allocated by the PS HANDOVER COMMAND message.
- In case of a non-synchronized PS handover the target BSS shall, upon reception of the first PS HANDOVER ACCESS message containing the expected Handover Reference value, send the PACKET PHYSICAL INFORMATION message to the mobile station and then enable the reception of RLC data blocks on all uplink TBFs allocated by the PS HANDOVER COMMAND message.
- The BSS should schedule USFs on at least one uplink TBF in the target cell to minimize the delay incurred by the mobile station waiting for a USF in the target cell.

The target BSS considers the PS handover procedure to be successfully completed upon receiving the first correct uplink RLC block on any of the uplink TBFs allocated to the mobile station in the PS HANDOVER COMMAND message.

If the target BSS supports blind transmission it may begin transmitting downlink data that becomes available prior to determining that the PS handover procedure has been successfully completed. Otherwise, it may discard downlink data that becomes available prior to determining that the PS handover procedure has been successfully completed.

If the target BSS supports network sharing in the target cell and the MS Radio Access Capabilities IE (see 3GPP TS 24.008) indicates a network sharing supporting MS, it shall include in the PS HANDOVER COMMAND message the *Selected PLMN Index* field (see sub-clause 10.4.27) corresponding to the PLMN received in the Target Cell Identifier IE in the PS HANDOVER REQUEST message (see 3GPP TS 48.018).

### 8.10.3.3 GERAN A/Gb to Iu/E-UTRAN PS Handover

For the case of PS handover from *A/Gb mode* to *Iu mode* or E-UTRAN the source BSS proceeds as described above for the normal case of *A/Gb mode* to *A/Gb mode* PS handover except for the following:

- The source BSS shall create a complete PS HANDOVER COMMAND message using local values for the Page Mode, Global TFI and Container ID information elements and therefore shall not send these information elements to the target RNC or eNB.
- For the case of PS handover to *Iu mode*, the source BSS receives a complete Handover to UTRAN Command message from the target RNC (passed through the SGSN) and sends it to the mobile station within a PS HANDOVER COMMAND message.
- For the case of PS handover to E-UTRAN, the source BSS receives a complete (RRC E-UTRA) HandoverCommand message as defined in 3GPP TS 36.331 [45] from the target eNB (passed through the MME and SGSN) and sends it to the mobile station within a PS HANDOVER COMMAND message.



- The source BSS shall not send the mobile station unsolicited PACKET NEIGHBOUR CELL DATA messages in the old cell as system information corresponding to the new cell is sent to the mobile station in the new cell as described in 3GPP TS 25.331 and 3GPP TS 44.118 (for PS handover to *Iu mode*) or as described in 3GPP TS 36.331 (for PS handover to E-UTRAN).

#### 8.10.3.4 Iu/E-UTRAN to GERAN A/Gb PS Handover

For the case of PS handover from *Iu mode* or E-UTRAN to *A/Gb mode* the target BSS proceeds as described above for the normal case of *A/Gb mode* to *A/Gb mode* PS handover except that a complete PS HANDOVER COMMAND message is created by the target BSS using local values for the Page Mode, Global TFI and Container ID information elements (i.e. they are not passed to the target BSS from the source RNC or eNB) and the PS HANDOVER COMMAND message shall always indicate RLC reset and non-synchronized PS handover. The PS HANDOVER COMMAND message is sent to the MS as part of the *MobilityFromEUTRACCommand* in E-UTRAN as specified in 3GPP TS 36.331 [45].

#### 8.10.3.5 A/Gb to GAN PS Handover

When the BSS and the mobile station support PS handover to *GAN mode* the normal case of *A/Gb mode* to *A/Gb mode* PS handover is followed as described in sub-clause 8.10.3.2 except for the following:

- The target GANC shall only provide values for the mandatory fields within the PS Handover Radio Resources IE included within the PS HANDOVER COMMAND message it sends back to the source BSS.
- The source BSS will not send the mobile station system information corresponding to the target GAN cell prior to sending it a PS HANDOVER COMMAND message (i.e. the mobile station acquires the system information required for the target GAN cell during GAN registration - see 3GPP TS 44.318 [42]).

#### 8.10.3.6 GAN to A/Gb PS Handover

For the case of PS handover from *GAN mode* to *A/Gb mode* the source GANC proceeds as described in 3GPP TS 44.318 [42]. The target BSS proceeds as described in sub-clause 8.10.3.2 for the normal case of *A/Gb mode* to *A/Gb mode* PS handover except that a complete PS HANDOVER COMMAND message is created by the target BSS using local values for the Page Mode, Global TFI and Container ID information elements (i.e. they are not passed to the target BSS from the source GANC) and the PS HANDOVER COMMAND message shall always indicate RLC reset for each PFC and non-synchronized PS handover.

### 8.10.4 PS Handover at the mobile station side

#### 8.10.4.1 A/Gb to A/Gb PS Handover

Upon reception of the PS HANDOVER COMMAND message for PS handover from *A/Gb mode* to *A/Gb mode*, the mobile station shall proceed as follows:

- If an RLC/MAC control block containing a part of the PS HANDOVER COMMAND message contains a valid RRBP field or a polling response is outstanding the mobile station shall send a corresponding PACKET CONTROL ACKNOWLEDGMENT message (in the specified uplink radio block) prior to switching to the new cell.
- RLC/MAC control plane signalling shall be suspended except for the signalling needed to complete the PS handover procedure or to signal a failure of the PS handover procedure.
- The mobile station shall suspend the uplink transmission of user plane data.
- Each outstanding request for establishment or reconfiguration of an uplink TBF in the old cell shall be aborted and the corresponding instance of T3168 shall be stopped.
- All timers related to the RLC contexts in the old cell keep running.
- Timers T3180 and T3190 related to the ongoing TBFs in the old cell and which are currently running shall be re-started.

- If the timer T3192 related to a TBF in the old cell expires, the mobile station shall consider the corresponding TBF that was ongoing in the old cell as implicitly released.
- The mobile station shall start timer T3218, move to the new cell and perform the physical channel establishment as described in sub-clause 8.10.4.4.
- The mobile station may receive downlink RLC data blocks in the new cell prior to determining that the PS handover has been successfully completed if the target BSS uses blind transmission. If this occurs the mobile station shall forward the corresponding user data to upper layers if the PS HANDOVER COMMAND message did not include the *NAS Container for PS Handover IE*. Otherwise, the mobile station may either discard the received RLC data blocks or buffer them until the successful completion of the PS handover procedure at which point the corresponding user data shall be deciphered by the upper layers based on information contained within the *NAS Container for PS Handover IE*.

NOTE: It is expected that PS Handover procedure will be completed successfully or terminated before the expiry of T3180 or T3190 and therefore that the MS will not release any TBFs due to the expiry of T3180 or T3190 during the PS Handover procedure. The mobile station considers the PS handover procedure to be successfully completed in the following cases:

- Upon receiving a PACKET PHYSICAL INFORMATION message in the new cell in case of a non-synchronized PS handover (see sub-clause 8.10.4.4.3).
- Upon detecting the first USF for any uplink TBF assigned to the MS in the new cell in case of a synchronized and pre-synchronized PS handover (see subclause 8.10.4.4.1 and 8.10.4.4.2).

If the mobile station is waiting for the PACKET PHYSICAL INFORMATION message when it receives a downlink RLC data block in which a valid polling indication is provided, it shall ignore the polling indication.

Upon successfully completing the PS handover procedure the mobile station shall proceed as follows:

- Stop T3216 (if running), consider all TBFs that were ongoing in the old cell as implicitly released and if the *NAS Container for PS Handover IE* was included in the PS HANDOVER COMMAND message it shall be sent to upper layers.
- If the PS HANDOVER COMMAND indicates RLC reset the mobile station shall initialize new RLC entities to support the allocated TBFs. Otherwise, the TBFs allocated in the new cell shall be supported using the same RLC entities used to support the TBFs in the old cell corresponding to the same PFCs (i.e. the RLC state machines are maintained across PS handover).
- The mobile station shall resume the uplink transmission of user plane data.
- The mobile station shall trigger a cell update or other GMM specific procedures, as appropriate according to the GMM requirements (see 3GPP TS 24.008).

#### 8.10.4.2 A/Gb to Iu/E-UTRAN PS Handover

Upon receiving a PS HANDOVER COMMAND message for PS handover from GERAN A/Gb mode to *Iu mode* or E-UTRAN, the mobile station shall act on the message if it is able to perform PS handover based on the content of the received message. If the PS HANDOVER COMMAND message is acted on the mobile station shall start the PS handover procedure and proceed as described above for the case of *A/Gb mode to A/Gb mode* PS handover while in the old cell. Upon moving to the new cell the mobile station shall proceed as described in 3GPP TS 25.331 for handover to *Iu mode* or as described in 3GPP TS 36.331 for handover to *E-UTRAN*. Upon successfully completing the PS handover procedure all TBFs that were ongoing in the old cell shall be considered as implicitly released.

#### 8.10.4.3 Iu/E-UTRAN to A/Gb PS Handover

Upon receiving a Handover from UTRAN Command message for PS handover from *Iu mode* to *A/Gb mode* or a *MobilityFromEUTRACommand* message for PS handover from *E-UTRAN* to *A/Gb mode*, the mobile station shall act on the message if all of the following conditions are satisfied:

- It is able to perform PS handover based on the content of the received message.
- The Handover from UTRAN Command or *MobilityFromEUTRACommand* message contains the minimum set of PSI or SI messages required for mobile station to operate in the new cell (see sub-clause 8.10.4.1.).

- The PS HANDOVER COMMAND message carried within the Handover from UTRAN Command or *MobilityFromEUTRACommand* message provides resources for at least one uplink TBF in the new cell.

If the Handover from UTRAN Command or *MobilityFromEUTRACommand* message is acted on the mobile station shall start the PS handover procedure and proceed as follows:

- The mobile station shall act as described in 3GPP TS 25.331 and 3GPP TS 44.118 (for handover from *Iu mode*) or as described in 3GPP TS 36.331 (for handover from E-UTRAN) prior to switching to the new cell except for the following:
  - It shall ignore the value of the Page Mode, Global TFI and Container ID information elements included in the PS HANDOVER COMMAND message carried within the Handover from UTRAN Command or *MobilityFromEUTRACommand* message.
- After switching to the new cell the mobile station shall proceed as described above for the case of *A/Gb mode* to *A/Gb mode* PS handover except for the following:
  - Upon successfully completing the PS handover procedure the mobile station shall stop T3216 (if running), consider all radio bearers that were ongoing in the old cell as implicitly released, send the *NAS Container for PS Handover* IE to upper layers if it was included in the PS HANDOVER COMMAND message, start an instance of T3180 corresponding to each uplink TBF allocated by the PS HANDOVER COMMAND message and start an instance of T3190 corresponding to each downlink TBF allocated by the PS HANDOVER COMMAND message.
  - Upon successfully completing the PS handover procedure the mobile station shall always establish a new RLC entity for each TBF allocated by the PS HANDOVER COMMAND message.

#### 8.10.4.4 Physical channel establishment

##### 8.10.4.4.1 General

Three procedures are defined. The support of them is mandatory in the mobile station.

If the network requests the transmission of the PS HANDOVER ACCESS message it shall be sent with highest transmission priority using either the 8-bit or 11-bit access burst format on the PACCH associated with any uplink TBF allocated in the PS HANDOVER COMMAND message for which the mobile station detects an assigned USF value. Its content consists of the handover reference field. The burst format used shall be that specified by the ACCESS\_BURST\_TYPE in the system information for the target cell.

Upon detecting the first USF for any uplink TBF assigned to the MS in the new cell, the MS shall stop T3218.

##### 8.10.4.4.2 Synchronized cell case

If the timing advance with the new cell calculated by the mobile station is not out of range, i.e. smaller than or equal to the maximum timing advance that can be coded as specified in 3GPP TS 44.004, or if the new cell does accept out of range timing advance as indicated in the PS HANDOVER COMMAND message, the mobile station acts on the message.

After having switched to the assigned channels, if the Handover Reference information is included within the PS HANDOVER COMMAND message the mobile station shall send four times the PS HANDOVER ACCESS message.

The mobile station activates the channels in sending and receiving mode. The MS may activate the channels in downlink while sending access bursts.

##### 8.10.4.4.3 Pre-synchronized cell case

The details of the use of this procedure are described in 3GPP TS 45.010.

After having switched to the assigned channels, if the Handover Reference information is included within the PS HANDOVER COMMAND message the mobile station shall send four times the PS HANDOVER ACCESS message.

The mobile station activates the channels in sending and receiving mode. The MS may activate the channels in downlink while sending access bursts.

The timing advance value to be used with the new cell is:

- either the value contained in the PS HANDOVER COMMAND message if the timing advance information is included; or
- the default value for pre-synchronized handover as defined in 3GPP TS 45.010, if the timing advance information element is not included in the PS HANDOVER COMMAND message.

#### 8.10.4.4 Non synchronized cell case

After having switched to the assigned channels, the mobile station shall send four times the PS HANDOVER ACCESS message. The mobile station shall start timer T3216 at the start point of the timeslot in which the PS HANDOVER ACCESS message is sent the first time on the PACCH.

The mobile station then activates the channels in receiving mode.

Upon reception of the PS HANDOVER ACCESS message containing the expected Handover Reference value, once the network has the RF characteristics that are necessary, it sends a PACKET PHYSICAL INFORMATION message to the mobile station on the PACCH.

When the mobile station receives a PACKET PHYSICAL INFORMATION message, it stops timer T3216, stops sending access bursts and activates the channels in sending and receiving mode.

#### 8.10.4.5 A/Gb to GAN PS Handover

Upon successfully performing a GAN registration (see 3GPP TS 43.129 [43]), a mobile station in packet transfer mode may trigger a PS handover to a GAN cell by sending a PACKET CELL CHANGE NOTIFICATION message (see sub-clause 8.8.3). The mobile station may send the PACKET CELL CHANGE NOTIFICATION message either at the first possible transmission opportunity following GAN registration if GAN mode is preferred or when the GERAN cell becomes sufficiently degraded if GERAN/UTRAN mode is preferred. If the network and the mobile station support PS handover to *GAN mode*, the network may initiate the PS handover procedure. The mobile station shall then proceed as described in sub-clause 8.10.4.1 for the case of *A/Gb mode* to *A/Gb mode* PS handover except for the following:

- Since the mobile station provides an ARFCN and BSIC corresponding to a GAN cell within the PACKET CELL CHANGE NOTIFICATION message it does not expect a valid minimum set of PSI or SI messages prior to receiving a PS HANDOVER COMMAND message directing it to a GAN cell.
- Upon receiving a PS HANDOVER COMMAND message the MS determines that PS handover to a GAN cell has been ordered if the ARFCN and BSIC included within the message matches the corresponding values it included within the PACKET CELL CHANGE NOTIFICATION message.
- After successful PS handover to the GAN cell (see 3GPP TS 44.318 [42]) the mobile station switches to GAN mode and considers all TBFs that were ongoing in the old cell as implicitly released.

#### 8.10.4.6 GAN to A/Gb PS Handover

Upon receiving a GA-PSR HANDOVER COMMAND message for PS handover from *GAN mode* to *A/Gb mode*, a mobile station that supports GAN PS handover shall act on the message as described in 3GPP TS 44.318 [42] prior to switching to the new cell. After switching to the new cell the mobile station shall proceed as described in sub-clause 8.10.4.1 for the case of *A/Gb mode* to *A/Gb mode* PS handover except for the following:

- None of the actions corresponding to TBFs in the old cell are applicable.
- Upon successful completion of the PS handover procedure the mobile station shall consider the GA-PSR Transport Channel used in the old cell as implicitly released.
- The mobile station shall always establish a new RLC entity for each TBF allocated by the PS HANDOVER COMMAND message (i.e. regardless if an intra-SGSN or an inter-SGSN PS handover was performed).

## 8.10.5 Abnormal Cases

### 8.10.5.1 MS Behaviour for A/Gb to A/Gb PS Handover

A mobile station operating in *A/Gb mode* shall consider the PS handover to *A/Gb mode* to have failed if the PS HANDOVER COMMAND message:

- contains an invalid Frequency Parameters information element; or
- contains specifying frequencies that are not all in one frequency band; or
- contains a Frequency Parameters information element specifying a frequency that is in a frequency band not supported by the mobile station; or
- does not properly specify an uplink or downlink PDCH or specifies a multislot configuration that the mobile station does not support (see 3GPP TS 45.002); or
- does not provide resources for at least one uplink TBF in the new cell; or
- would result in one or more TBFs with FANR activated and one or more TBFs with FANR not activated for that mobile station; or
- includes an inconsistent RTTI configuration assignment as per the conditions specified in sub-clause 7.1.3.6; or
- contains any other failure.

A mobile station operating in *A/Gb mode* shall consider the PS handover to *A/Gb mode* to have failed for the following reasons:

- In the synchronized cell case (see sub-clause 8.10.4.4.1), if the timing advance with the new cell calculated by the mobile station is out of range, i.e. is bigger than the maximum timing advance that can be coded as specified in 3GPP TS 44.004, and if the new cell does not accept out of range timing advance as indicated in the PS HANDOVER COMMAND message.
- If it has not stored a valid minimum set of the following of PSI or SI messages (provided via PACKET NEIGHBOUR CELL DATA messages, see sub-clause 8.8.1) required for mobile station to operate in the new cell: PSI1, a consistent set of PSI2 messages and PSI14 (if PBCCH allocated in the new cell) or SI3, SI1 (if present in the new cell) and SI13 messages (if PBCCH not allocated in the new cell).
- Timer T3218 expires while in the new cell.
- Timer T3216 expires while in the new cell.

A mobile station operating in *A/Gb mode* when a PS handover to *A/Gb mode* fails shall proceed as follows:

- If timer T3218 expired it shall return to the cell on which the PS HANDOVER COMMAND message was received.
- If timer T3216 expired it shall return to the cell on which the PS HANDOVER COMMAND message was received.
- Send a PACKET CELL CHANGE FAILURE message with the cause code set to "No response on target cell" if timer T3218 or T3216 expired, otherwise "PS Handover failure-others". The message shall be sent on PACCH.
- The transmission of a PACKET CELL CHANGE FAILURE message terminates the PS handover procedure in the mobile station and after the transmission of this message the mobile station is therefore allowed to request the establishment of additional uplink TBFs.
- After terminating the PS handover procedure the mobile station shall resume all uplink and downlink TBFs that were ongoing in the old cell prior to receiving the PS HANDOVER COMMAND message. Timers T3180 (uplink TBFs) and T3190 (downlink TBFs) corresponding to these TBFs shall be re-started.
- For each TBF that is resumed the corresponding RLC state machine shall reflect its state when the last RLC data block was transmitted for that TBF in the old cell (uplink TBFs) and the last RLC data block was received for that TBF in the old cell (downlink TBFs).

### 8.10.5.2 MS Behaviour for A/Gb to Iu/E-UTRAN PS Handover

A mobile station operating in *A/Gb mode* shall consider PS handover to *Iu mode* or E-UTRAN to have failed if it is unable to perform PS handover for any reason based on the content of the received PS HANDOVER COMMAND message.

A mobile station operating in *A/Gb mode* when a PS handover to *Iu mode* or E-UTRAN fails shall proceed as described above for the case where PS handover from *A/Gb mode* to *A/Gb mode* fails except that T3216 shall never be running.

### 8.10.5.3 MS Behaviour for Iu/E-UTRAN to A/Gb PS Handover

A mobile station operating in *Iu mode* or E-UTRAN shall consider PS handover to *A/Gb mode* to have failed for the following reasons:

- It is unable to perform PS handover for any reason based on the content of the received Handover from UTRAN Command or *MobilityFromEUTRACommand* message.
- The Handover from UTRAN Command or *MobilityFromEUTRACommand* message does not contain the minimum set of PSI or SI messages required for mobile station to operate in the new cell (see sub-clause 8.10.2).
- Timer T3218 expires while in the new cell.
- Timer T3216 expires while in the new cell.
- The PS HANDOVER COMMAND message carried within the Handover from UTRAN Command or *MobilityFromEUTRACommand* message does not provide resources for at least one uplink TBF in the new cell.
- The PS HANDOVER COMMAND message would result in one or more TBFs with FANR activated and one or more TBFs with FANR not activated for that mobile station.
- The PS HANDOVER COMMAND message includes an inconsistent RTTI configuration assignment as per the conditions specified in sub-clause 7.1.3.6.

A mobile station operating in *Iu mode* when a PS handover to *A/Gb mode* fails shall return to the cell it was in prior to receiving the Handover from UTRAN Command message (if T3216 or T3218 expired) and proceed as described in 3GPP TS 25.331 and 3GPP TS 44.118.

A mobile station operating in E-UTRAN when a PS handover to *A/Gb mode* fails shall return to the cell it was in prior to receiving the *MobilityFromEUTRACommand* message (if T3216 or T3218 expired) and proceed as described in 3GPP TS 36.331.

### 8.10.5.4 BSS Behaviour for PS Handover from A/Gb

The source BSS shall terminate the PS handover procedure if any of the following events occur:

- All TBFs allocated to the mobile station in the old cell are released at any point prior to sending the PS HANDOVER COMMAND message to the mobile station.
- The source BSS receives a PACKET CELL CHANGE FAILURE message or any other RLC block from the mobile station after sending the final segment of the PS HANDOVER COMMAND message, if the network does not request acknowledgement of receipt of that segment (i.e. does not include in any segment a valid RRBP field requiring the mobile station to send a PACKET CONTROL ACKNOWLEDGEMENT message), or after the receipt of a PACKET CONTROL ACKNOWLEDGEMENT message indicating that the mobile station has received the final segment of the PS HANDOVER COMMAND message.

If the PS handover procedure is terminated for either of the above reasons, the (source) BSS shall resume all uplink and downlink TBFs that were ongoing in the old cell for that MS prior to sending the PS HANDOVER COMMAND message. For normal PS Handover the source BSS shall then indicate the PS handover failure to the SGSN. For optimized PS Handover the source BSS shall then release all resources associated with the new TBFs.

For each TBF that is resumed the corresponding RLC state machine shall reflect its state when the last RLC data block was transmitted for that TBF in the old cell (downlink TBFs) and the last RLC data block was received for that TBF in the old cell (uplink TBFs).

For both the normal and optimized cases of PS Handover, after sending the PS HANDOVER COMMAND to the MS, the source BSS shall continue to schedule transmission opportunities for the mobile station for a period of time sufficiently long to allow the mobile station to transmit a PACKET CELL CHANGE FAILURE message (should a PS handover failure occur).

For normal PS Handover, if the source BSS does not receive any RLC/MAC block from the MS and does not receive (a) DELETE-BSS-PFC PDU(s) from the SGSN for all ongoing PFCs during this time period, the source BSS shall consider radio contact with the MS to be lost and shall release all resources related to the MS and initiate the PS Handover Cancel procedure (see 3GPP TS 48.018), by sending a PS-HANDOVER-CANCEL PDU to the SGSN with cause "Radio contact lost with MS".

For optimized PS Handover, if the BSS does not receive any RLC/MAC block from the MS on any of the old TBFs and does not receive an uplink RLC data block from the MS on any of the new TBFs during this time period, the BSS shall consider the MS to be lost and therefore release all resources associated with the new TBFs and old TBFs.

#### 8.10.5.5 BSS Behaviour for PS Handover to A/Gb

If the (target) BSS expects but does not receive any PS HANDOVER ACCESS messages from the mobile station it considers the PS handover procedure to have failed and shall release all TBFs allocated to the mobile station in the new cell.

If the (target) BSS expects but does not receive the correct Handover Reference value from the mobile station it considers the PS handover procedure to have failed and shall release all TBFs allocated to the mobile station in the new cell.

#### 8.10.5.6 MS Behaviour for A/Gb to GAN PS Handover

Upon receiving a PS HANDOVER COMMAND message in the source cell, if connectivity has been lost on the corresponding GA-PSR Transport Channel the MS shall discard the PS HANDOVER COMMAND message and send the source BSS a PACKET CELL CHANGE FAILURE message with the cause code set to "PS Handover failure".

#### 8.10.5.7 MS Behaviour for GAN to A/Gb PS Handover

See 3GPP 44.318 [42].

---

## 9 Radio Link Control (RLC) procedures in packet transfer mode

### 9.0 General

The RLC function is responsible for:

- Interface primitives allowing the transfer of upper layer PDUs between the upper layer and the MAC function;
- Segmentation of upper layer PDUs into RLC data blocks and re-assembly of RLC data blocks into upper layer PDUs;
- Segmentation of RLC/MAC control messages into RLC/MAC control blocks and re-assembly of RLC/MAC control messages from RLC/MAC control blocks.;
- Backward Error Correction (BEC) procedures enabling the selective retransmission of RLC data blocks.

In this clause Packet Ack/Nack refers to any of the following messages or field:

- PACKET DOWNLINK ACK/NACK, EGPRS PACKET DOWNLINK ACK/NACK, EGPRS PACKET DOWNLINK ACK/NACK TYPE 2, EGPRS PACKET DOWNLINK ACK/NACK TYPE 3 or EGPRS PACKET DOWNLINK ACK/NACK DLDC or MBMS DOWNLINK ACK/NACK;
- PACKET UPLINK ACK/NACK;

- PAN.

Additionally the following definitions apply:

- Sequence Number Space (SNS): 2048 in EGPRS, and 128 in GPRS:
  - 128 in GPRS,
  - 2048 in EGPRS,
  - 2048 or 8192 in DLMC configuration (see sub-clause 5.13);
- Window Size (WS):
  - GPRS: 64
  - EGPRS: 64 to 1024
  - DLMC configuration (EGPRS): determined by the buffer size supported by a mobile station (see Table 9.1.9.3.2).

A mobile station that supports multiple TBF procedures can operate multiple RLC entities simultaneously each one with its own set of RLC parameters (e.g. sequence number; receive and transmit windows etc.).

If a mobile station in a DLMC configuration using a SNS of 8192 is reconfigured so that it leaves DLMC configuration while the downlink TBF remains assigned, it shall continue using a SNS of 8192. A mobile station that supports DLMC configuration and has a downlink TBF with a single downlink carrier assigned (i.e. it is not in a DLMC configuration) shall immediately begin using a SNS of 8192 if the maximum number of downlink timeslots it supports (see 3GPP TS 24.008) is greater than 20 and either of the following occurs:

- It receives an assignment message that causes it to enter DLMC configuration, the assignment message indicates an SNS of 8192 shall be used, and it is not already using a SNS of 8192.
- It experiences PS Handover to a DLMC configuration and the PS HANDOVER COMMAND message indicates an SNS of 8192 shall be used.

## 9.1 Procedures and parameters for peer-to-peer operation

A TBF is comprised of two peer entities, which are the RLC endpoints. In case of EMST, a TBF is comprised of one, two or three pairs of peer RLC entities, which are the RLC endpoints. Each RLC endpoint has a receiver that receives RLC/MAC blocks. Each RLC endpoint also has a transmitter that transmits RLC/MAC blocks.

An MBMS bearer is comprised of one transmitting RLC endpoint at the network side and several receiving RLC endpoints, one for each mobile station involved in the p-t-m transmission. The transmitting RLC endpoint transmits RLC/MAC data and control blocks and may receive only RLC/MAC control blocks. Each receiving RLC endpoint receives RLC/MAC data and control blocks and may transmit only RLC/MAC control blocks, upon polling. An MBMS bearer operates in RLC non-persistent mode (see also sub-clause 9.3.4).

Each endpoint's receiver has a receive window of size WS (see sub-clause 9.1.9).

In RLC acknowledged mode, the receive window is defined by the receive window state variable  $V(Q)$  in the following inequality  $[V(Q) \leq BSN < V(Q) + WS]$  modulo SNS (for the method of interpreting inequalities in this format refer to sub-clause 9.1.8). All BSNs which meet that criteria are valid within the receive window.

In RLC unacknowledged mode, all values of BSN are within the receive window.

In RLC non-persistent mode, the receive window is determined after recalculating the receive state variable  $V(R)$  (as described in sub-clause 9.1.5) and the corresponding receive window state variable  $V(Q)$  (as described in sub-clause 9.1.6.4). All BSNs which meet the following inequality  $[V(Q) \leq BSN \leq V(R)]$  modulo SNS are valid within the receive window.

An RLC data block is considered received, when it is received in a layer 1 frame with consistent parity bits (in EGPRS TBF mode: header and relevant data parity bits) and correctly addresses the receiving RLC endpoint.



Each endpoint's transmitter has a transmit window of size  $WS$ . In RLC acknowledged mode and in RLC non-persistent mode, the transmit window is defined by the send state variable  $V(S)$  in the following inequality:  $[ V(A) \leq BSN < V(S) ]$  modulo  $SNS$ , where  $[ V(S) - V(A) ]$  modulo  $SNS \leq WS$ . All BSNs which meet that criteria are valid within the transmit window. In RLC unacknowledged mode, all values of BSN are within the transmit window.

In RLC non-persistent mode, if the NPM Transfer Time limitation is used then the network shall not change the NPM Transfer Time value. The mobile station shall ignore any NPM Transfer Time different from what is currently being used. If EMSR is enabled for an RLC entity operating in RLC Non-persistent mode then an independent NPM Transfer Time limitation may be assigned for each PFC assigned a unique TFI.

### 9.1.1 Send state variable $V(S)$

Each RLC endpoint transmitter shall have an associated send state variable  $V(S)$ .  $V(S)$  denotes the sequence number of the next in-sequence RLC data block to be transmitted.  $V(S)$  can take on the value 0 through  $SNS - 1$ .  $V(S)$  shall be set to the value 0 at the beginning of each TBF in which the RLC endpoint is the transmitter. The value of  $V(S)$  shall be incremented by 1 after transmission of the RLC data block with  $BSN = V(S)$ . In RLC acknowledged mode,  $V(S)$  shall not exceed  $V(A)$  modulo  $SNS$  by more than the maximum allowed number of outstanding RLC data blocks  $WS$ . In RLC non-persistent mode,  $V(S)$  may be incremented independently on the value of  $V(A)$ . When EMSR is enabled, a single send state variable  $V(S)$  is maintained regardless of how many PFCs share a given RLC entity.

#### 9.1.1a Control send state variable $V(CS)$

The network RLC endpoint transmitter shall have one instance of an associated control send state variable  $V(CS)$  for each parallel control transaction identified by the RTI field of the RLC/MAC control block header.  $V(CS)$  denotes the sequence number of the next in-sequence RLC/MAC control block to be transmitted for the control transaction.  $V(CS)$  can take on the values 0 or 1 when RLC/MAC control message segmentation into two RLC/MAC control blocks is used, and the values 0 to 8 when extended RLC/MAC control message segmentation is used (see sub-clause 9.1.12a).  $V(CS)$  shall be set to the value 0 prior to the transmission of each RLC/MAC control block that contains the first octet of an RLC/MAC control message of the control transaction and the value of  $V(CS)$  shall be set to 1 after the transmission of the RLC/MAC control block with  $RBSN = 0$ . The value of  $V(CS)$  shall then be incremented by 1, when extended RLC/MAC control message segmentation is used, after the transmission of the next in-sequence RLC/MAC control block and so on.

#### 9.1.2 Acknowledge state variable $V(A)$

In RLC acknowledged mode, each RLC endpoint transmitter shall have an associated acknowledge state variable  $V(A)$ .  $V(A)$  contains the BSN value of the oldest RLC data block that has not been positively acknowledged by its peer.  $V(A)$  can take on the values 0 through  $SNS - 1$ .  $V(A)$  shall be set to the value 0 at the beginning of each TBF in which the RLC endpoint is the transmitter. The value of  $V(A)$  shall be updated from the values received from its peer in the received block bitmap (RBB) of the PACKET UPLINK ACK/NACK message, the EGPRS PACKET DOWNLINK ACK/NACK message, the EGPRS PACKET DOWNLINK ACK/NACK TYPE 2 message or the EGPRS PACKET DOWNLINK ACK/NACK TYPE 3 message or the EGPRS PACKET DOWNLINK ACK/NACK DLMC message (see sub-clause 9.1.8)

Furthermore,  $[ V(S) - V(A) ]$  modulo  $SNS \leq WS$ .

In RLC non-persistent mode, each RLC endpoint transmitter shall have an associated acknowledge state variable  $V(A)$ .  $V(A)$  contains the BSN value of the oldest RLC data block that has not yet been positively acknowledged by the corresponding peer or peers and whose BSN satisfies the inequality  $[ V(S) - BSN ]$  modulo  $SNS \leq WS$ .  $V(A)$  can take on the values 0 through  $SNS - 1$ .  $V(A)$  shall be set to the value 0 at the beginning of each MBMS bearer or EGPRS TBF for which the RLC endpoint is the transmitter.

- When RLC non-persistent mode is used for an MBMS bearer the value of  $V(A)$  shall be updated from the values received from its peers in the received block bitmap (RBB) of the MBMS DOWNLINK ACK/NACK message (see sub-clause 9.1.8).
- When RLC non-persistent mode is used for an EGPRS TBF the value of  $V(A)$  shall be updated from the values received from its peer in the PACKET UPLINK ACK/NACK message, the EGPRS PACKET DOWNLINK ACK/NACK message, the EGPRS PACKET DOWNLINK ACK/NACK TYPE 2 message, the EGPRS PACKET DOWNLINK ACK/NACK TYPE 3 message, the EGPRS PACKET DOWNLINK ACK/NACK DLMC message or the PAN field.

- $V(A)$  shall be set to  $BSN''$ , where  $BSN''$  is the BSN value of the oldest RLC data block not yet positively acknowledged by the corresponding peer or peers which meets the condition  $[V(S) - BSN'']$  modulo  $SNS \leq WS$ , or it shall be set to  $V(S)$  if all RLC data blocks have been positively acknowledged by the corresponding peer or peers.

### 9.1.3 Acknowledge state array $V(B)$

#### 9.1.3.1 Acknowledge state array $V(B)$ for GPRS TBF Mode

In RLC acknowledged mode, each RLC endpoint transmitter shall have an associated acknowledge state array ( $V(B)$ ).  $V(B)$  is an array of SNS elements indicating the acknowledgement status of WS previous RLC data blocks. The array is indexed relative to the acknowledge state variable  $V(A)$  modulo SNS. The values of  $V(B)$  shall be updated from the values received from its peer in the received block bitmap (RBB) of the Packet Ack/Nack message (see sub-clause 9.1.8)

The transmitter shall transmit the oldest RLC data block whose corresponding element in  $V(B)$  indexed relative to  $V(A)$  has the value NACKED. As each RLC data block is transmitted the corresponding element in  $V(B)$  is set to the value PENDING\_ACK.

If  $[V(S) < V(A) + WS]$  modulo SNS and no RLC data blocks have a corresponding element in  $V(B)$  with the value NACKED, the RLC data block with  $BSN = V(S)$  shall be transmitted and the corresponding element in  $V(B)$  shall be set to the value PENDING\_ACK. If there are no further RLC data blocks available for transmission (i.e. the RLC data block with  $BSN = V(S)$  does not exist), the sending side shall transmit the oldest RLC data block whose corresponding element in  $V(B)$  has the value PENDING\_ACK, then the next oldest block whose corresponding element in  $V(B)$  has the value PENDING\_ACK, etc. If all RLC data blocks whose corresponding element in  $V(B)$  has the value PENDING\_ACK have been transmitted once, the process shall be repeated beginning with the oldest RLC data block.

If  $V(S) = V(A) + WS$  modulo SNS (i.e. the transmit window is stalled), the sending side shall transmit the oldest RLC data block whose corresponding element in  $V(B)$  has the value PENDING\_ACK, then the next oldest RLC data block whose corresponding element in  $V(B)$  has the value PENDING\_ACK, etc. If all RLC data blocks whose corresponding element in  $V(B)$  has the value PENDING\_ACK has been transmitted once, the process shall be repeated beginning with the oldest RLC data block. This process of transmitting the oldest RLC data blocks whose value in  $V(B)$  has the value PENDING\_ACK shall continue, as long as equation  $[V(S) = V(A) + WS]$  modulo SNS holds.

When an element in  $V(B)$  falls outside of the active transmit window, i.e.  $[V(A) \leq BSN < V(S)]$  modulo SNS, the element shall be set to the value INVALID.

In the extended uplink TBF mode, if  $V(S) = V(A)$  and there is no RLC data block with  $BSN = V(S)$  available, the mobile station shall stop sending RLC data blocks. The mobile station shall continue sending RLC data blocks when a RLC data block with  $BSN = V(S)$  is available.

#### 9.1.3.2 Acknowledge State Array $V(B)$ for EGPRS TBF Mode

##### 9.1.3.2.1 EGPRS TBF running in RLC acknowledged mode

In RLC acknowledged mode, each RLC endpoint transmitter shall have an associated acknowledge state array ( $V(B)$ ).  $V(B)$  is an array of SNS elements indicating the acknowledgement status of WS previous RLC data blocks. The array is indexed relative to the acknowledge state variable  $V(A)$  modulo SNS. The values of  $V(B)$  shall be updated from the values received from its peer in the reported bitmap (RB) of the Packet Ack/Nack message (see sub-clause 9.1.8). If a compressed reported bitmap is received, decompression shall be first applied according to sub-clause 9.1.10.

The transmitter shall transmit the oldest RLC data block whose corresponding element in  $V(B)$  indexed relative to  $V(A)$  has the value NACKED. As each RLC data block is transmitted the corresponding element in  $V(B)$  is set to the value PENDING\_ACK. If the RLC data block to be transmitted is split over two radio blocks, both radio blocks shall be transmitted. As an exception, if the transmitter supports DTR,  $[V(S) < V(A) + WS]$  modulo SNS and the RLC data block with  $BSN = V(S)$  is available, the transmitter may transmit the RLC data block with  $BSN = V(S)$  instead of the oldest RLC data block whose corresponding element in  $V(B)$  has the value NACKED.

NOTE: This exception should only be used to avoid a mobile station entering DTR mode or the network believing that a mobile station may have entered DTR mode (see sub-clause 8.1.8.2) when the transmitter has received new data from the upper layers.

If  $[ V(S) < V(A) + WS ]$  modulo SNS and no RLC data blocks have a corresponding element in  $V(B)$  with the value NACKED, the RLC data block with  $BSN = V(S)$  shall be transmitted and the corresponding element in  $V(B)$  shall be set to the value PENDING\_ACK. If the transmitter is the mobile station, the pre-emptive transmission bit is set to '1' in the PACKET UPLINK ACK/NACK message and there are no further RLC data blocks available for transmission (i.e. the RLC data block with  $BSN = V(S)$  does not exist), the sending side shall retransmit the oldest RLC data block whose corresponding element in  $V(B)$  has the value PENDING\_ACK, then the next oldest block whose corresponding element in  $V(B)$  has the value PENDING\_ACK, etc. If in this case there are no RLC data blocks whose corresponding element in  $V(B)$  has the value PENDING\_ACK and either the uplink TBF is not operated in extended uplink TBF mode or the uplink TBF is operated in extended uplink TBF mode but the mobile station shall not refrain from sending an RLC/MAC block (i.e. EXT\_UTBF\_NODATA is set to '0'), the sending side shall retransmit the oldest RLC data block whose corresponding element in  $V(B)$  has the value TENTATIVE\_ACK, then the next oldest block whose corresponding element in  $V(B)$  has the value TENTATIVE\_ACK, etc. This entire procedure shall be repeated, starting with the oldest RLC data block whose corresponding element in  $V(B)$  has the value PENDING\_ACK or has the value TENTATIVE\_ACK if no element has the value PENDING\_ACK, for as long as the applicable conditions for pre-emptive retransmission are true.

If  $[ V(S) = V(A) + WS ]$  modulo SNS (i.e. the transmit window is stalled), the sending side shall transmit the oldest RLC data block whose corresponding element in  $V(B)$  has the value PENDING\_ACK, then the next oldest RLC data block whose corresponding element in  $V(B)$  has the value PENDING\_ACK, etc. If in this case there are no RLC data blocks whose corresponding element in  $V(B)$  has the value PENDING\_ACK and either the uplink TBF is not operated in extended uplink TBF mode or the uplink TBF is operated in extended uplink TBF mode but the mobile station shall not refrain from sending an RLC/MAC block (i.e. EXT\_UTBF\_NODATA is set to '0'), the sending side shall retransmit the oldest RLC data block whose corresponding element in  $V(B)$  has the value TENTATIVE\_ACK, then the next oldest block whose corresponding element in  $V(B)$  has the value TENTATIVE\_ACK, etc. This process of retransmitting RLC data blocks whose value in  $V(B)$  has the value PENDING\_ACK (or TENTATIVE\_ACK) shall be repeated, starting with the oldest RLC data block whose corresponding element in  $V(B)$  has the value PENDING\_ACK or has the value TENTATIVE\_ACK if no element of  $V(B)$  has the value PENDING\_ACK, as long as equation  $[ V(S) = V(A) + WS ]$  modulo SNS holds. If the transmitter is the mobile station and the pre-emptive transmission bit is set to '0' in the PACKET UPLINK ACK/NACK message the transmitter shall not retransmit RLC data blocks whose corresponding element in  $V(B)$  has the value PENDING\_ACK or TENTATIVE\_ACK. When a PACKET UPLINK ACK/NACK message or a PAN field is received the mobile station shall retransmit the RLC blocks which are set to NACKED in  $V(B)$  and new RLC data blocks as far as the transmit window (if advanced) allows. However if the RLC data block is the last in the TBF it shall be retransmitted even if its state is PENDING\_ACK or TENTATIVE\_ACK. The default for the mobile side is that the transmitter shall use pre-emptive retransmission. If the transmitter is on the network side this process (pre-emptive retransmission) of retransmitting the oldest RLC data blocks whose value in  $V(B)$  has the value PENDING\_ACK or TENTATIVE\_ACK is optional.

NOTE: If the Mobile Station only has RLC data blocks whose value in  $V(B)$  has the value PENDING\_ACK or TENTATIVE\_ACK and the pre-emptive transmission bit is set to '0', the rules defined in sub-clause 8.1.1 apply (i.e. PACKET UPLINK DUMMY CONTROL BLOCK messages are sent).

If the mobile station has been polled for a PAN, and the data blocks specified for transmission according to the rules in this sub-clause all have corresponding elements in  $V(B)$  whose value is TENTATIVE\_ACK then no RLC data block shall be transmitted (see sub-clause 8.1.1.).

When an element in  $V(B)$  falls outside of the active transmit window, i.e.  $[ V(A) \leq BSN < V(S) ]$  modulo SNS, the element shall be set to the value INVALID.

In the extended uplink TBF mode, if  $V(S) = V(A)$  and there is no RLC data block with  $BSN = V(S)$  available, the mobile station shall stop sending RLC data blocks. The mobile station shall continue sending RLC data blocks when a RLC data block with  $BSN = V(S)$  is available.

When Enhanced Flexible Timeslot Assignment, EFTA, is used, and the applicable conditions for pre-emptive retransmission are true, the mobile station shall not prioritize uplink radio block transmission over attempting to read downlink radio blocks.

### 9.1.3.2.2 EGPRS TBF running in RLC non-persistent mode

In RLC non-persistent mode, each RLC endpoint transmitter shall have an associated acknowledge state array ( $V(B)$ ).  $V(B)$  is an array of SNS elements indicating the acknowledgement status of WS previous RLC data blocks. The array is indexed relative to the acknowledge state variable  $V(A)$  modulo SNS. The values of  $V(B)$  shall be updated from the values received from its peer in the reported bitmap (RB) of the Packet Ack/Nack message (see sub-clause 9.1.8). If a compressed reported bitmap is received, decompression shall be first applied according to sub-clause 9.1.10.

The transmitter may transmit any RLC data block included in  $V(B)$ , e.g. those whose corresponding element in  $V(B)$  indexed relative to  $V(A)$  has the value NACKED. As each RLC data block is transmitted the corresponding element in  $V(B)$  is set to the value PENDING\_ACK. If an NPM Transfer Time limitation is associated with the TBF, the transmitting RLC endpoint shall start a timer with a value equal to the NPM Transfer Time (see Table 12.45a.1) each time it begins transmitting a new upper layer PDU. If the timer expires, the transmitting RLC endpoint should not (re)transmit any of the RLC data blocks corresponding to that upper layer PDU and not containing data from other LLC PDU(s) whose timer has not yet expired.

When an element in  $V(B)$  falls outside of the active transmit window, i.e.  $[ V(A) \leq BSN < V(S) ]$  modulo SNS, the element shall be set to the value INVALID.

If the RLC data block to be transmitted is split over two radio blocks, both radio blocks shall be transmitted. The selection of the Puncturing Scheme (PS) shall be performed according to sub-clause 9.3.2.1.

In the extended uplink TBF mode, if  $V(S) = V(A)$  and there is no RLC data block with  $BSN = V(S)$  available, the mobile station shall stop sending RLC data blocks. The mobile station shall continue sending RLC data blocks when a RLC data block with  $BSN = V(S)$  is available.

### 9.1.3.3 Acknowledge State Array $V(B)$ for MBMS Bearers

The RLC endpoint transmitter shall have an associated acknowledge state array ( $V(B)$ ).  $V(B)$  is an array of SNS elements indicating the acknowledgement status of WS previous RLC data blocks. The array is indexed relative to the acknowledge state variable  $V(A)$  modulo SNS.

The values of  $V(B)$  shall be updated from the values received from its peers in the reported bitmap (RB) of the MBMS DOWNLINK ACK/NACK message (see sub-clause 9.1.8). If a compressed reported bitmap is received, decompression shall be first applied according to sub-clause 9.1.10.

The transmitter may retransmit any RLC data block included in  $V(B)$ , e.g. those whose corresponding element in  $V(B)$  indexed relative to  $V(A)$  have the value NACKED. As each RLC data block is transmitted the corresponding element in  $V(B)$  is set to the value PENDING\_ACK. If an NPM Transfer Time limitation is associated with the MBMS bearer, the transmitting RLC endpoint shall start a timer with a value equal to the NPM Transfer Time (see Table 12.45a.1) each time it begins transmitting a new upper layer PDU. If the timer expires, the transmitting RLC endpoint should not (re)transmit any of the RLC data blocks corresponding to that upper layer PDU and not containing data from other LLC PDU(s) whose timer has not yet expired.

When an element in  $V(B)$  falls outside of the active transmit window, i.e.  $[ V(A) \leq BSN < V(S) ]$  modulo SNS, the element shall be set to the value INVALID.

For an MBMS bearer running in EGPRS TBF mode, if the RLC data block intended for retransmission is split over two radio blocks, both radio blocks shall be transmitted. The selection of the Puncturing Scheme (PS) shall be performed according to sub-clause 9.3.2.1.

## 9.1.4 Block sequence number BSN

### 9.1.4.1 Block sequence number BSN for GPRS TBF

Each RLC data block contains a block sequence number (BSN) field that is 7 bits in length. At the time that an in-sequence RLC data block is designated for transmission, the value of BSN is set equal to the value of the send state variable  $V(S)$ .

### 9.1.4.2 Block sequence number BSN for EGPRS TBF

Each RLC data block contains a block sequence number (BSN) field that is 11 bits in length or, for the case of a DL1MC configuration where a SNS of 8192 is used (see sub-clause 5.13), 13 bits long. At the time that an in-sequence RLC data block is designated for transmission, the value of BSN is set equal to the value of the send state variable  $V(S)$ .

### 9.1.4a Reduced Block Sequence Number RBSN

Each downlink RLC/MAC control block contains a Reduced Block Sequence Number (RBSN) bit. At the time that an in-sequence RLC/MAC control block is designated for transmission, the value of RBSN is set equal to the value of the

control send state variable  $V(CS)$ , except when extended RLC/MAC control message segmentation is used, in which case the value of RBSN is set equal to "0" for the first RLC/MAC control block, and to "1" for the second RLC/MAC control block onwards.

### 9.1.4b Reduced Block Sequence Number extension RBSNe

When extended RLC/MAC control message segmentation is used, the second to the ninth RLC/MAC control blocks shall contain a Reduced Block Sequence Number extension (RBSNe) field. The first RLC/MAC control block shall not contain a RBSNe field (see sub-clause 10.4.12b). At the time that an in-sequence RLC/MAC control block is designated for transmission, the value of RBSNe is set equal to the value of the control send state variable  $V(CS)$  minus 1.

### 9.1.5 Receive state variable $V(R)$

Each RLC endpoint receiver shall have an associated receive state variable  $V(R)$ . The receive state variable denotes the BSN which has a value one higher than the highest BSN of those corresponding to the RLC data blocks so far received (modulo SNS).  $V(R)$  shall be set to the value '0' at the beginning of each TBF in which the RLC endpoint is the receiver.  $V(R)$  can take on the value 0 through SNS - 1. When EMSR is enabled, a single receive state variable  $V(R)$  is maintained regardless of how many PFCs share a given RLC entity.

In RLC acknowledged mode,  $V(R)$  shall be set to  $[BSN' + 1]$  modulo SNS, where  $BSN'$  is the highest BSN of those corresponding to received RLC data blocks, provided  $[V(R) \leq BSN' < V(Q) + WS]$  modulo SNS.

In RLC unacknowledged mode,  $V(R)$  shall be set to  $[BSN' + 1]$  modulo SNS, where  $BSN'$  is the highest BSN of those corresponding to received RLC data blocks.

In RLC non-persistent mode,  $V(R)$  of each receiving RLC endpoint shall be set to  $[BSN' + 1]$  modulo SNS, where  $BSN'$  is the highest BSN of those corresponding to received RLC data blocks, provided  $[V(R) \leq BSN' < V(R) + SNS - WS]$  modulo SNS.

### 9.1.6 Receive window state variable $V(Q)$

#### 9.1.6.1 General

Each RLC endpoint receiver shall have an associated receive window state variable  $V(Q)$ . The receive window state variable denotes the lowest BSN not yet received (modulo SNS), therefore representing the start of the receive window.  $V(Q)$  shall be set to the value 0 at the beginning of each TBF in which the RLC endpoint is the receiver. The receive window state variable can take on the value 0 through SNS - 1.

#### 9.1.6.2 RLC acknowledged mode

In RLC acknowledged mode, the value of  $V(Q)$  shall be updated when the RLC receiver receives the RLC data block whose BSN is equal to  $V(Q)$ . The value of  $V(Q)$  shall then be set to the BSN value of the next RLC data block in the receive window (modulo SNS) that has not yet been received, or it shall be set to  $V(R)$  if all RLC data blocks in the receive window have been received.

#### 9.1.6.3 RLC unacknowledged mode

In RLC unacknowledged mode, if  $[V(R) - V(Q)]$  modulo SNS  $>$  WS after updating  $V(R)$ , then  $V(Q)$  is set to  $[V(R) - WS]$  modulo SNS.

#### 9.1.6.4 RLC non-persistent mode

In RLC non-persistent mode,  $V(Q)$  of each receiving RLC endpoint shall be set to  $V(R)$  if all RLC data blocks in the receive window have been received or to  $BSN''$ , where  $BSN''$  is the lowest BSN of those corresponding to RLC data blocks not yet received which:

- meets the condition  $[V(R) - BSN'']$  modulo SNS  $\leq$  WS and
- it is still expected by the receiving RLC endpoint.

If an NPM Transfer Time limitation is associated with the corresponding MBMS bearer/EGPRS TBF, the receiving RLC endpoint shall start a timer with a value equal to the NPM Transfer Time (see Table 12.45a.1) for an RLC data block with BSN equal to BSN" if at the end of a radio block period that data block is first detected as missing i.e. when both of the following conditions are first met for BSN":

- the RLC data block with sequence number BSN" has not been received, and
- an RLC/MAC header containing a BSN equal to or higher than BSN" (modulo SNS) has been received.

The timer shall be started at most once for any given RLC data block. The timer shall not be restarted in the event of an out-of-sequence retransmission (i.e. where the endpoint is expecting a retransmission of that block but receives a retransmission of a block with higher BSN). The timer shall be stopped on reception of the RLC data block.

RLC data blocks are considered not expected if they have been received or (if an NPM Transfer Time limitation is associated with the corresponding MBMS bearer/EGPRS TBF) the corresponding timer has been stopped or has expired.

## 9.1.7 Receive state array V(N)

### 9.1.7.1 Receive state array V(N) in GPRS TBF

Each RLC endpoint receiver shall have an associated receive state array V(N). V(N) is an array of SNS elements indicating the receive status of WS previous RLC data blocks. The array is indexed relative to the receive state variable V(R) modulo SNS. When an RLC data block is received with BSN within the receive window, V(R) is treated according to sub-clause 9.1.5 and the element in V(N) corresponding to the received RLC data block is set to the value RECEIVED.

An element in V(N), corresponding to a BSN such that  $[ V(R) \leq BSN < V(R) - WS ]$  modulo SNS, shall be set to the value INVALID.

### 9.1.7.2 Receive state array V(N) in EGPRS TBF

Each RLC endpoint receiver shall have an associated receive state array V(N). V(N) is an array of SNS elements indicating the receive status of WS RLC data blocks that are supposed to follow the block  $BSN=V(Q)-1$ . The array is indexed relative to the receive window state variable V(Q) modulo SNS. When an RLC data block is received with BSN within the receive window, the corresponding element in V(N) is set to the value RECEIVED.

If the RLC data block is split over two radio blocks, the element shall be set to the value RECEIVED if and only if both radio blocks have been received.

The elements in V(N) shall be set to the value INVALID at the beginning of each TBF. During the TBF, an element in V(N) that falls outside the receive window, shall be set to the value INVALID.

### 9.1.7.3 Receive state array V(N) in TBF with FANR activated

Each RLC endpoint receiver shall have an associated receive state array V(N). V(N) is an array of SNS elements indicating the receive status of RLC data blocks that are supposed to follow the block  $BSN=V(Q)-1$ . The array is indexed relative to the receive window state variable V(Q) modulo SNS. When an RLC data block is received with BSN within the receive window, the corresponding element in V(N) shall be set to the value RECEIVED.

If the RLC data block is split over two radio blocks, the element shall be set to the value RECEIVED if and only if both radio blocks have been received.

The elements in V(N) shall be set to the value INVALID at the beginning of each TBF. During the TBF, an element in V(N) that falls outside the receive window shall be set to the value INVALID.

When an EGPRS RLC/MAC header is received, for each BSN' within the receive window included in the header the elements of V(N) shall be updated as follows:

- if EFTA is not used, or if EFTA is used and the receiving RLC endpoint is in the network, and if the corresponding element in V(N) has the value INVALID, all elements of V(N) with the value INVALID and

corresponding to RLC data blocks with BSN satisfying the following inequality  $[V(Q) \leq \text{BSN} < \text{BSN}']$  modulo SNS shall be set to the value UNREPORTED;

- if the corresponding element in  $V(N)$  has the value REPORTED, all elements of  $V(N)$  with the value REPORTED and corresponding to RLC data blocks with BSN satisfying the following inequality  $[\text{BSN}'' \leq \text{BSN} < \text{BSN}']$  modulo SNS shall be set to the value UNREPORTED, where  $\text{BSN}''$  is:
  - the BSN of the newest RLC data block for which the corresponding element in  $V(N)$  has the value UNREPORTED, if such a block exists, otherwise
  - $V(Q)$ .

An element in  $V(N)$  whose value is UNREPORTED shall be set to the value REPORTED when the status of the corresponding block is indicated in the RB of a Packet Ack/Nack. This includes the block with  $\text{BSN} = \text{SSN} - 1$ , if the status of that block is implicitly reported in a Packet Ack/Nack.

If the data field of the RLC/MAC block with sequence number  $\text{BSN}'$  could not be decoded and the corresponding element in  $V(N)$  has the value INVALID or REPORTED, then this element shall also be set to the value UNREPORTED.

NOTE: The elements in  $V(N)$  with the value UNREPORTED correspond to RLC data blocks detected as missing due to e.g. the out-of-sequence reception of a data block. The elements in  $V(N)$  with the value REPORTED correspond to missing RLC data blocks whose state was indicated in the RB of a Packet Ack/Nack and have not been detected missing since then.

## 9.1.8 Starting sequence number (SSN) and received block bitmap (RBB)

### 9.1.8.1 Starting sequence number (SSN) and received block bitmap (RBB) in GPRS TBF

The Packet Ack/Nack message contains a starting sequence number (SSN) and a received block bitmap (RBB). The Packet Ack/Nack message is sent by the RLC receiver and is received by the RLC transmitter. The SSN and RBB are determined as defined in this sub-clause and transmitted in RLC acknowledged, RLC unacknowledged and RLC non-persistent modes. The SSN and RBB may be ignored by the RLC transmitter in unacknowledged mode.

The RBB is defined as a binary valued array of WS elements, where the index of each element takes value 0, 1, 2, ..., WS-1 in the given order, respectively. The BSN values specified in the RBB are interpreted by subtracting the bit position in the bitmap from the starting sequence number (SSN) modulo SNS.

A valid BSN value in the RBB is one that is in the range  $[V(A) \leq \text{BSN} < V(S)]$  modulo SNS.

These inequalities shall be interpreted in the following way:

BSN is valid if, and only if,  $[\text{BSN} - V(A)]$  modulo SNS  $< [V(S) - V(A)]$  modulo SNS.

At the RLC transmitter:

- For each bit in the RBB whose corresponding BSN value is within the transmit window, if the bit contains the value '1', the corresponding element in  $V(B)$  indexed relative to SSN shall be set to the value ACKED. If the bit contains the value '0', the element in  $V(B)$  shall be set to the value NACKED. A bit within the RBB whose corresponding BSN is not within the transmit window, shall be ignored. If the RLC transmitter is on the mobile station side, the bit contains the value '0' and the number of block periods between the end of the block period used for the last transmission of the corresponding RLC data block and the beginning of the block period containing the Packet Uplink Ack/Nack message is less than  $(\max(\text{BS\_CV\_MAX}, 1) - 1)$  (i.e. the RLC data block was recently (re)transmitted and thus can not be validly negatively acknowledged in this particular Packet Uplink Ack/Nack message), the element in  $V(B)$  shall not be modified.

At the RLC receiver:

- The starting sequence number (SSN) is assigned the value of the receive state variable  $V(R)$ . The received block bitmap (RBB) is assigned the WS elements whose indices, with incrementing order, correspond to elements in the receive state array  $V(N)$  at the receiver whose indices, with decrementing order, range backwards from  $[V(R) - 1]$  to  $[V(R) - \text{WS}]$  (modulo SNS). For each bit in the bitmap, the bit is assigned the value '1' if the

corresponding element in  $V(N)$  indexed relative to SSN has the value RECEIVED. The bit is assigned the value '0' if the element in  $V(N)$  has the value INVALID.

- When polled within a downlink RLC data block, the mobile station shall acknowledge all the RLC data blocks for this RLC instance that have been correctly received up to and including the radio block where the mobile station is polled.
- As an implementation option, the mobile station may also acknowledge as many as possible of the RLC data blocks that are correctly received after the radio block where the mobile station is polled.

### 9.1.8.2 Starting sequence number (SSN) and received block bitmap (RBB) in EGPRS TBF

The Packet Ack/Nack message and MBMS DOWNLINK ACK/NACK message contain a starting sequence number (SSN) and a reported bitmap (RB). When the SSN-based encoding is used (see sub-clause 9.1.14.1), the PAN field included in an EGPRS RLC/MAC block for data transfer contains a short SSN (ShortSSN) and a reported bitmap (RB). The Packet Ack/Nack message, MBMS DOWNLINK ACK/NACK message and PAN field are sent by the RLC receiver and are received by the RLC transmitter. The SSN and RB are determined as defined in this sub-clause and transmitted in RLC acknowledged, RLC unacknowledged and RLC non-persistent modes (note the SSN is calculated differently in EGPRS (refer to table 9.1.8.2.2.1) and GPRS (refer to sub-clause 9.1.8.1)). The SSN and RB may be ignored by the RLC transmitter in unacknowledged mode. For a TBF with FANR activated, the ShortSSN (and corresponding SSN) is determined as defined in sub-clause 9.1.8.2.2a and the RB is determined as defined for EGPRS (see sub-clause 9.1.8.2.3). The ShortSSN and RB fields are transmitted in both RLC acknowledged and RLC non-persistent modes.

The BSN values specified in the RB are interpreted by adding the bit position in the bitmap to the starting sequence number (SSN) modulo SNS (where the first position of the bitmap has index '0'). A valid BSN value in the RB is one that is in the range  $[V(A) \leq BSN < V(S)]$  modulo SNS. These inequalities shall be interpreted in the following way: BSN is valid if, and only if,  $[BSN - V(A)]$  modulo SNS  $< [V(S) - V(A)]$  modulo SNS.

#### 9.1.8.2.1 Extended Polling

For EGPRS uplink TBFs, the network may select any composition of the Packet Ack/Nack message to send to the mobile station. In EGPRS downlink TBFs and MBMS bearers running in EGPRS TBF mode, the ES/P field present in every downlink RLC block allows the network to request one of the following Ack/Nack bitmap types:

- First Partial Bitmap (FPB) segment with  $SSN = (V(Q) + 1) \bmod SNS$  (the beginning of the window is  $V(Q)$  but FPB starts at  $V(Q) + 1$  as the bit in the bitmap corresponding to  $V(Q)$  would have value '0') where SSN denotes the Starting Sequence Number.
- Next Partial Bitmap (NPB) segment with  $SSN = (PBSN + 1) \bmod SNS$  where PBSN denotes a Partial Bitmap Sequence Number variable stored at the receiver.

SSN is determined by the receiver as a function of ES/P,  $V(Q)$  and PBSN as described in the next sub-clause. The FPB and NPB are specific instances of the *EGPRS Ack/Nack Description Information Element* within the EGPRS PACKET DOWNLINK ACK/NACK message, EGPRS PACKET DOWNLINK ACK/NACK TYPE 2 message, EGPRS PACKET DOWNLINK ACK/NACK TYPE 3 message or MBMS DOWNLINK ACK/NACK message or specific instances of the *EGPRS Ack/Nack Description DLDC Information Element* within the EGPRS PACKET DOWNLINK ACK/NACK DLDC message. The mobile station shall respond to ES/P field according to table 9.1.8.2.1.1 (non-MBMS) or table 9.1.8.2.1.2 (MBMS). For a mobile station with one or more downlink TBFs using EGPRS2, the mobile station shall send the EGPRS PACKET DOWNLINK ACK/NACK TYPE 2 message or the EGPRS PACKET DOWNLINK ACK/NACK TYPE 3 message. A mobile station in a DLDC configuration using an SNS of 2048 shall always send the EGPRS PACKET DOWNLINK ACK/NACK DLDC message. Otherwise, the mobile station shall send the EGPRS PACKET DOWNLINK ACK/NACK message or the EGPRS PACKET DOWNLINK ACK/NACK TYPE 3 message.



**Table 9.1.8.2.1.1: Format of ES/P field within each EGPRS RLC block (non-MBMS)**

ES/P	Feedback Request (Poll) Description
00	Nothing (RRBP field invalid)
01	EGPRS PACKET DOWNLINK ACK/NACK message or EGPRS PACKET DOWNLINK ACK/NACK TYPE 3 message or EGPRS PACKET DOWNLINK ACK/NACK DLMC message containing FPB (First Partial Bitmap), and if there is enough room left in RLC/MAC block, channel quality report(s)
10	EGPRS PACKET DOWNLINK ACK/NACK message or EGPRS PACKET DOWNLINK ACK/NACK TYPE 3 message or EGPRS PACKET DOWNLINK ACK/NACK DLMC message containing NPB (Next Partial Bitmap), and if there is enough room left in RLC/MAC block, channel quality report(s)
11	EGPRS PACKET DOWNLINK ACK/NACK message or EGPRS PACKET DOWNLINK ACK/NACK TYPE 3 message or EGPRS PACKET DOWNLINK ACK/NACK DLMC message containing Channel Quality Report and if there is enough room left in RLC/MAC block, NPB(s)

In a downlink dual carrier configuration the MS shall send channel quality reports for both carriers, if there is room in the message. If there is room for only one channel quality report, the MS shall include channel quality measurements for the radio frequency channel on which the poll was received.

**Table 9.1.8.2.1.2: Format of ES/P field within each EGPRS RLC block (MBMS)**

ES/P	Feedback Request (Poll) Description
00	Nothing (RRBP field invalid)
01	MBMS DOWNLINK ACK/NACK message containing FPB (First Partial Bitmap)
10	MBMS DOWNLINK ACK/NACK message containing NPB (Next Partial Bitmap)
11	MBMS DOWNLINK ACK/NACK message containing neighbour cell measurement reports and NPB

For EGPRS when FANR is activated or for EGPRS2, the Combined EGPRS Supplementary/Polling field describes the feedback request and specifies a single uplink block in which the mobile station shall transmit a PACKET CONTROL ACKNOWLEDGEMENT message, a PACCH block or (applicable only if FANR is activated) a radio block containing a PAN field to the network, see table 9.1.8.2.1.3. The single uplink block is defined by a delay relative to the first TDMA frame (N) of the downlink block containing the CES/P value. If ordered to send an EGPRS PACKET DOWNLINK ACK/NACK message or EGPRS PACKET DOWNLINK ACK/NACK TYPE 2 message or EGPRS PACKET DOWNLINK ACK/NACK TYPE 3 message, a mobile station with one or more downlink TBFs using EGPRS2 shall send the EGPRS PACKET DOWNLINK ACK/NACK TYPE 2 message or EGPRS PACKET DOWNLINK ACK/NACK TYPE 3 message. A mobile station in a DLMC configuration using an SNS of 2048 shall always send the EGPRS PACKET DOWNLINK ACK/NACK DLMC message. Otherwise, the mobile station shall send the EGPRS PACKET DOWNLINK ACK/NACK message.

**Table 9.1.8.2.1.3: Format of CES/P field within each EGPRS RLC block (EGPRS with FANR activated and EGPRS2)**

CES/P	Feedback Request (Poll) Description and Relative Reserved Block Period
000	Nothing
001	EGPRS PACKET DOWNLINK ACK/NACK message or EGPRS PACKET DOWNLINK ACK/NACK TYPE 2 message or EGPRS PACKET DOWNLINK ACK/NACK TYPE 3 message or EGPRS PACKET DOWNLINK ACK/NACK DLMC message containing FPB, and if there is enough room left in RLC/MAC block, channel quality report(s) within the radio period $(N+8 \text{ or } N+9) \bmod 2715648$ in the BTTI configuration or $(N+6 \text{ or } N+7) \bmod 2715648$ in the RTTI configuration
010	EGPRS PACKET DOWNLINK ACK/NACK message or EGPRS PACKET DOWNLINK ACK/NACK TYPE 2 message or EGPRS PACKET DOWNLINK ACK/NACK TYPE 3 message or EGPRS PACKET DOWNLINK ACK/NACK DLMC message containing FPB, and if there is enough room left in RLC/MAC block, channel quality report(s) within the radio period $(N+13) \bmod 2715648$ in the BTTI configuration or $(N+8 \text{ or } N+9) \bmod 2715648$ in the RTTI configuration
011	EGPRS RLC/MAC block for data transfer with a PAN field containing FPB within the radio period $(N+8 \text{ or } N+9) \bmod 2715648$ in the BTTI configuration or $(N+6 \text{ or } N+7) \bmod 2715648$ in the RTTI configuration (NOTE 1)
100	EGPRS RLC/MAC block for data transfer with a PAN field containing FPB within the radio period $(N+13) \bmod 2715648$ in the BTTI configuration or $(N+8 \text{ or } N+9) \bmod 2715648$ in the RTTI configuration (NOTE 1)
101	EGPRS PACKET DOWNLINK ACK/NACK message or EGPRS PACKET DOWNLINK ACK/NACK TYPE 2 message or EGPRS PACKET DOWNLINK ACK/NACK TYPE 3 message or EGPRS PACKET DOWNLINK ACK/NACK DLMC message containing Channel Quality Report(s) and if there is enough room left in RLC/MAC block, NPB within the radio period $(N+8 \text{ or } N+9) \bmod 2715648$ in the BTTI configuration or $(N+6 \text{ or } N+7) \bmod 2715648$ in the RTTI configuration (NOTE 2)
110	EGPRS PACKET DOWNLINK ACK/NACK message or EGPRS PACKET DOWNLINK ACK/NACK TYPE 2 message or EGPRS PACKET DOWNLINK ACK/NACK TYPE 3 message or EGPRS PACKET DOWNLINK ACK/NACK DLMC message containing Channel Quality Report(s) and if there is enough room left in RLC/MAC block, NPB within the radio period $(N+13) \bmod 2715648$ in the BTTI configuration or $(N+8 \text{ or } N+9) \bmod 2715648$ in the RTTI configuration (NOTE 2)
111	EGPRS PACKET DOWNLINK ACK/NACK message or EGPRS PACKET DOWNLINK ACK/NACK TYPE 2 message or EGPRS PACKET DOWNLINK ACK/NACK TYPE 3 message or EGPRS PACKET DOWNLINK ACK/NACK DLMC message containing NPB, and if there is enough room left in RLC/MAC block, channel quality report(s) within the radio period $(N+8 \text{ or } N+9) \bmod 2715648$ in the BTTI configuration or $(N+6 \text{ or } N+7) \bmod 2715648$ in the RTTI configuration (NOTE 2)
NOTE 1: The mobile station shall ignore the poll for PAN in the case when received for a TBF with FANR not activated.	
NOTE 2: The mobile station shall not truncate the <i>EGPRS Ack/Nack Description</i> IE in the EGPRS PACKET DOWNLINK ACK/NACK TYPE 2 message (see sub-clause 11.2.6e) or EGPRS PACKET DOWNLINK ACK/NACK TYPE 3 message (see sub-clause 11.2.6f) that would contain a final Ack indicator set to '1'.	

A mobile station in DLMC configuration using an SNS of 8192 shall respond to the feedback request indicated by the CES/P field within the RLC data block header (see sub-clause 10.3a.3.1, 10.3a.3.2, 10.3a.3.3, 10.3a.3.4, 10.3a.3.5 and 10.3a.3.10) as shown in Table 9.1.8.2.1.4.

**Table 9.1.8.2.1.4: Format of CES/P field within each DLMC EGPRS RLC block (EGPRS with FANR activated and EGPRS2)**

CES/P	Feedback Request (Poll) Description and Relative Reserved Block Period
00	Nothing
01	EGPRS PACKET DOWNLINK ACK/NACK DLMC message containing FPB, and if there is enough room left in the RLC/MAC block, channel quality report(s) within the radio period $(N+8 \text{ or } N+9) \bmod 2715648$ in the BTTI configuration or $(N+6 \text{ or } N+7) \bmod 2715648$ in the RTTI configuration
10	EGPRS PACKET DOWNLINK ACK/NACK DLMC message containing Channel Quality Report(s) and if there is enough room left in the RLC/MAC block, NPB within the radio period $(N+8 \text{ or } N+9) \bmod 2715648$ in the BTTI configuration or $(N+6 \text{ or } N+7) \bmod 2715648$ in the RTTI configuration (NOTE 1)
11	EGPRS RLC/MAC block for data transfer with a PAN field containing FPB within the radio period $(N+8 \text{ or } N+9) \bmod 2715648$ in the BTTI configuration or $(N+6 \text{ or } N+7) \bmod 2715648$ in the RTTI configuration (NOTE 2)
NOTE 1: The mobile station shall not truncate the <i>EGPRS Ack/Nack Description</i> IE in the EGPRS PACKET DOWNLINK ACK/NACK DLMC message (see sub-clause 11.2.48) that would contain a final Ack indicator set to '1'.	
NOTE 2: The mobile station shall ignore the poll for PAN in the case when received for a TBF with FANR not activated.	

In a DLMC configuration, when the MS sends channel quality report information it shall use the value of the DLMC Measurement Type field (see sub-clause 11.2.7) within the most recently received assignment message as follows:

- If this field indicates measurement information is to be reported on a per UFPS basis the MS shall always include channel quality measurements for the UFPS corresponding to the radio frequency channel on which the poll was received. If there is room in the message (see sub-clause 11.2.48) the MS shall report additional higher numbered UFPS (if any) beginning with the next in sequence UFPS (see sub-clause 8.1.1.1.3 for the numbering of UFPS and 3GPP TS 45.008 [15] for how DLMC BEP Link Quality Measurements are reported on a per UFPS basis).
- If this field indicates measurement information is to be reported on a per carrier basis the MS shall always include channel quality measurements for the carrier corresponding to the radio frequency channel on which the poll was received. If there is room in the message (see sub-clause 11.2.48) the MS shall report additional higher numbered carriers (if any) beginning with the next in sequence carrier (see sub-clause 8.1.1.1.3 for the numbering of downlink carriers in a DLMC configuration).

For MBMS bearers, in case cell re-selection criteria are not fulfilled (see 3GPP TS 45.008):

- If the ES/P field is set to "11" the mobile station shall include measurement reports for at least three neighbouring cells in addition to the NPB. If the complete NPB is included, the mobile station shall include measurement results for more neighbouring cells, if there is sufficient space;
- Else (i.e. the ES/P field is set to "01" or "10") the mobile station shall send as much of either the FPB or NPB (as specified in Table 9.1.8.2.1.2) as possible and, if the entire FPB/NPB is sent, measurement reports for as many neighbouring cells as can also be included.

For MBMS bearers, in case cell re-selection criteria are fulfilled towards a neighbouring cell (see 3GPP TS 45.008), the mobile station if polled shall include in the MBMS DOWNLINK ACK/NACK message the measurement report only for that cell and as much of either the First Partial Bitmap (FPB) or Next Partial Bitmap (NPB) (as specified in Table 9.1.8.2.1.2) as possible.

### 9.1.8.2.2 Determination of SSN

If the receiving side is the network, the network may select any SSN within the receive window. If the receiving side is the mobile station, SSN shall be determined as follows: Let PBSN represent a Partial Bitmap Sequence Number variable stored at the receiver which helps to determine the Starting Sequence Number (SSN) for the next partial bitmap to be transmitted. Based on PBSN,  $V(Q)$  and the ES/P field set by the network, SSN and PBSN shall be determined according to table 9.1.8.2.2.1. For EGPRS when FANR is activated and for EGPRS2, SSN and PBSN shall be determined based on PBSN,  $V(Q)$  and CES/P fields according to table 9.1.8.2.2.2 and 9.1.8.2.2.3.

**Table 9.1.8.2.2.1: Determination of SSN as a function of ES/P, V(Q) and PBSN**

Full bitmap (compressed or not)	ES/P	Determination of SSN
-	00	-
fits in available space	01, 10, 11	Set SSN = (V(Q)+1) modulo SNS set PBSN = V(Q).
does not fit in available space	01	Set SSN = (V(Q)+1) modulo SNS, set PBSN = last sequence number for which Ack/Nack status can be indicated in available space in EGPRS PACKET DOWNLINK ACK/NACK or EGPRS PACKET DOWNLINK ACK/NACK TYPE 2 or EGPRS PACKET DOWNLINK ACK/NACK TYPE 3 or EGPRS PACKET DOWNLINK ACK/NACK DLMC or MBMS DOWNLINK ACK/NACK message.
	10, 11	If (PBSN+1) modulo SNS = V(Q) or (PBSN+1) modulo SNS lies outside the receiver windowset SSN = (V(Q)+1) modulo SNS, else set SSN = (PBSN+1) modulo SNS and set PBSN = last sequence number for which Ack/Nack status can be indicated in available space in EGPRS PACKET DOWNLINK ACK/NACK or EGPRS PACKET DOWNLINK ACK/NACK TYPE 2 or EGPRS PACKET DOWNLINK ACK/NACK TYPE 3 or EGPRS PACKET DOWNLINK ACK/NACK DLMC or MBMS DOWNLINK ACK/NACK message.

**Table 9.1.8.2.2.2: Determination of SSN as a function of CES/P, V(Q) and PBSN**

Full bitmap (compressed or not)	CES/P	Determination of SSN
-	000	-
fits in available space	001, 010, 101, 110, 111	Set SSN = (V(Q)+1) modulo SNS set PBSN = V(Q).
does not fit in available space	001, 010	Set SSN = (V(Q)+1) modulo SNS, set PBSN = last sequence number for which Ack/Nack status can be indicated in available space in EGPRS PACKET DOWNLINK ACK/NACK or EGPRS PACKET DOWNLINK ACK/NACK TYPE 2 or EGPRS PACKET DOWNLINK ACK/NACK TYPE 3 or MBMS DOWNLINK ACK/NACK message.
	101, 110, 111	If (PBSN+1) modulo SNS = V(Q) or (PBSN+1) modulo SNS lies outside the receiver windowset SSN = (V(Q)+1) modulo SNS, else set SSN = (PBSN+1) modulo SNS and set PBSN = last sequence number for which Ack/Nack status can be indicated in available space in EGPRS PACKET DOWNLINK ACK/NACK or EGPRS PACKET DOWNLINK ACK/NACK TYPE 2 or EGPRS PACKET DOWNLINK ACK/NACK TYPE 3 or MBMS DOWNLINK ACK/NACK message. (see Note)
NOTE: For a TBF with FANR activated, the CES/P combinations "011" and "100" mean the mobile station is polled for a PAN (see sub-clause 10.4.4b). If the mobile station responds to the poll by transmitting an EGPRS RLC/MAC block for data transfer with a PAN field included (see sub-clause 8.1.2.2), SSN is determined as specified in sub-clause 9.1.8.2.2a. For a TBF with FANR not activated, the CES/P combinations "011" and "100" shall be ignored by the mobile station.		

**Table 9.1.8.2.2.3: Determination of SSN as a function of CES/P, V(Q) and PBSN (DLMC configuration using an SNS of 8192)**

Full bitmap (compressed or not)	CES/P	Determination of SSN
-	00	-
fits in available space	01, 10	Set SSN = (V(Q)+1) modulo SNS set PBSN = V(Q).
does not fit in available space	01	Set SSN = (V(Q)+1) modulo SNS, set PBSN = last sequence number for which Ack/Nack status can be indicated in available space in EGPRS PACKET DOWNLINK ACK/NACK DLMC message.
	10	If (PBSN+1) modulo SNS = V(Q) or (PBSN+1) modulo SNS lies outside the receiver window set SSN = (V(Q)+1) modulo SNS, else set SSN = (PBSN+1) modulo SNS and set PBSN = last sequence number for which Ack/Nack status can be indicated in available space in EGPRS PACKET DOWNLINK ACK/NACK DLMC. (see NOTE 1)
NOTE 1: The CES/P value "11" indicates the mobile station is polled for a PAN (see sub-clause 10.4.4b). If the mobile station responds to the poll by transmitting an EGPRS or EGPRS2 RLC/MAC block for data transfer with a PAN field included (see sub-clause 8.1.2.2), SSN is determined as specified in sub-clause 9.1.8.2.2a.		

When a next partial bitmap needs to be transmitted in response to a poll, it may turn out that  $(V(R)-PBSN) \bmod SNS$  is much smaller than the available space. In such cases, a larger amount of feedback can be provided as an implementation option if the receiver backtracks from PBSN and represents as much of the  $V(Q)$  to PBSN range as possible, in addition to the PBSN to  $V(R)$  range, possibly using compression. If backtracking is carried out, the SSN must be properly indicated within the Ack/Nack description in order to allow the transmitter to accurately interpret the feedback. For MBMS Bearers, this option may only apply if the cell re-selection criteria are fulfilled (see 3GPP TS 45.008).

#### 9.1.8.2.2a Determination of ShortSSN and SSN in the Piggy-backed Ack/Nack field

If the receiving side is the network, the network may select any SSN within the receive window. If the receiving side is the mobile station, SSN shall be determined as follows.

In case of polled FANR (see sub-clause 9.1.14.2), SSN shall be set to  $V(Q) + 1$ .

In case of event-based FANR, the SSN shall be set to the following value (where BSN' is the BSN of the oldest RLC data block of which the corresponding element in  $V(N)$  has the value UNREPORTED, and N is the number of bits in the bitmap):

- the higher of  $V(Q) + 1$  and  $V(R) - N$ , provided that the bitmap includes BSN', else
- BSN' + 1, if  $V(Q)$  is equal to BSN', else
- BSN', if  $V(Q)$  is not equal to BSN'.

The ShortSSN shall then be set to the value of the  $L$  least significant bits of SSN. The number  $L$  of bits is determined as defined in sub-clause 10.4.23.

#### 9.1.8.2.3 Generation of the bitmap

First, a Full Received Bitmap (FRB) is built from the receive state array  $V(N)$  by extracting the part between  $V(Q)$  and  $V(R)$  similar to the GPRS case: it is assigned the elements whose indices in the receive state array  $V(N)$  at the receiver range from  $[V(Q)+1]$  to  $[V(R)-1]$  (modulo SNS). For each bit in the bitmap, the bit is assigned the value '1' if the corresponding element in  $V(N)$  indexed relative to SSN has the value RECEIVED. The bit is assigned the value '0' if the element in  $V(N)$  has the value INVALID. For a TBF with FANR activated, the bit is assigned the value '0' also if the element in  $V(N)$  has the value UNREPORTED or REPORTED.

For EGPRS TBFs for which FANR is not active and for which neither downlink dual carrier configuration nor DLMC configuration nor EGPRS2 nor TBFs running in RLC non-persistent mode are used, the same principles and implementation options as for GPRS apply regarding the determination of  $V(R)$ .

For EGPRS TBFs for which FANR is not active and for which either downlink dual carrier configuration, or DLMC configuration or EGPRS2 or RLC non-persistent mode are used, when the mobile station is polled,  $V(R)$  shall be determined taking into account all RLC data blocks received up to and including those received in the radio block period where the poll is received.

For EGPRS TBFs for which FANR is active,  $V(R)$  and therefore the bitmap shall be determined taking into account all RLC data blocks received up to and including those received in the reduced radio block period  $m-2$  for RTTI configuration, and those received in the basic radio block period  $m-2$  for BTTI configuration, where the bitmap is sent in radio block period  $m$ .

From the FRB, a reported bitmap (RB) shall then be generated. The FRB shall be recalculated before each RB is generated, except that PAN fields transmitted during the same radio block period for the same TBF shall be based on the same FRB and the FRB shall therefore not be recalculated between the generation of these PAN fields. Different lengths of RBs exist (see clause 12 and sub-clause 10.3a.5). For uplink TBFs, the network may transmit any RB size to the mobile station. For downlink TBFs, the network may order the mobile station to transmit a certain RB size through use of the ES/P field. The bitmap size may be selected based on e.g. risk of protocol stalling. The RB in a PAN field is always uncompressed. In EGPRS PACKET DOWNLINK ACK/NACK, EGPRS PACKET DOWNLINK ACK/NACK TYPE 2, EGPRS PACKET DOWNLINK ACK/NACK TYPE 3 messages, and EGPRS PACKET DOWNLINK ACK/NACK DLMC the RB is one of the following types:

a) Uncompressed reported bitmap:

If the range of indices from SSN to the end of FRB is less than or equal to  $N$  bits, where  $N$  is the reported bitmap size, the RB starts at SSN and covers the range of indices from SSN to the end of FRB. When an RB is a part of a PAN field, if the number of indices from SSN to the end of FRB is less than  $N$  bits and the reported bitmap is generated by the mobile station, the bits not covering the FRB shall be set to the value "0". When an RB is a part of a PAN field, if the number of indices from SSN to the end of FRB is less than  $N$  bits and the reported bitmap is generated by the network, the bits not covering the FRB shall be set to the value "1". If the range of indices from SSN to the end of FRB is greater than  $N$  bits, the RB is assigned the first  $N$  bits of the FRB starting at SSN.

b) Compressed reported bitmap:

Using the compression algorithm, the receiver generates RB of length  $N$  bits starting at SSN, where  $N$  is the reported bitmap size used.

If the compressed reported bitmap covers more blocks than the uncompressed reported bitmap, the receiver shall send the compressed reported bitmap, otherwise the receiver shall send the uncompressed reported bitmap. As an exception, if the FRB length or the range of indices from SSN to the end of FRB is less than or equal to  $N$  bits, the receiver may send the uncompressed reported bitmap without attempting compression.

The BOW (begin of window) bit shall be set if  $SSN = [V(Q) + 1]$  modulo SNS, the EOW (end of window) bit shall be set if  $[V(R) - 1]$  modulo SNS is explicitly included in the bitmap.

If  $V(Q)$  equals  $V(R)$ , then SSN shall be set to the value  $SSN = [V(Q) + 1]$  modulo SNS, BOW bit shall be set to the value '1', EOW shall be set to the value '1' and the reported bitmap size shall equal 0 bits.

For uplink TBFs, the reported bitmap is sent using the PACKET UPLINK ACK/NACK message corresponding to the used RB size.

For downlink TBFs the reported bitmap is sent using the EGPRS PACKET DOWNLINK ACK/NACK TYPE 2 or EGPRS PACKET DOWNLINK ACK/NACK TYPE 3 message for mobiles with one or more downlink TBFs using EGPRS2, or using EGPRS PACKET DOWNLINK ACK/NACK or EGPRS PACKET DOWNLINK ACK/NACK TYPE 3 message otherwise. For MBMS bearers the reported bitmap is sent using the MBMS DOWNLINK ACK/NACK message. For a DLMC configuration the reported bitmap is sent using the EGPRS PACKET DOWNLINK ACK/NACK DLMC message.

#### 9.1.8.2.4 Interpretation of the bitmap

If a compressed reported bitmap is received, the bitmap shall first be decompressed according to sub-clause 9.1.10. The uncompressed bitmap shall then be treated as follows:

Firstly, if the BOW bit in PACKET UPLINK ACK/NACK, EGPRS PACKET DOWNLINK ACK/NACK, EGPRS PACKET DOWNLINK ACK/NACK TYPE 2 or EGPRS PACKET DOWNLINK ACK/NACK TYPE 3 or EGPRS PACKET DOWNLINK ACK/NACK DLMC message has the value '1', then the bitmap acknowledges all blocks between  $V(A)$  and  $(SSN - 2)$  (modulo SNS), and the corresponding elements in  $V(B)$  shall be set to the value ACKED. Also a bitmap value of '0' is assumed at the bit position corresponding to  $(SSN-1)$  modulo SNS which corresponds to  $V(Q)$ . If the BOW bit in MBMS DOWNLINK ACK/NACK message has the value '1', then the bitmap acknowledges all blocks between  $V(A)$  and  $(SSN-2)$  (modulo SNS), and a bitmap value of '0' is assumed at the bit position corresponding to  $(SSN-1)$  modulo SNS, only for the mobile station sending the message. The decision whether to set the corresponding elements in  $V(B)$  to the value ACKED is implementation specific.

Then, in case of PACKET UPLINK ACK/NACK, EGPRS PACKET DOWNLINK ACK/NACK, EGPRS PACKET DOWNLINK ACK/NACK TYPE 2 or EGPRS PACKET DOWNLINK ACK/NACK TYPE 3 or EGPRS PACKET DOWNLINK ACK/NACK DLMC message, for each bit in the uncompressed bitmap whose corresponding BSN value is within the transmit window, if the bit contains the value '1', the corresponding element in  $V(B)$  indexed relative to SSN shall be set to the value ACKED. If the bit contains the value '0', the element in  $V(B)$  shall be set to the value NACKED. A bit within the uncompressed bitmap whose corresponding BSN is not within the transmit window, shall be ignored. In case of MBMS DOWNLINK ACK/NACK message, for each bit in the uncompressed bitmap whose corresponding BSN value is within the transmit window, if the bit contains the value '1', it positively acknowledges the corresponding RLC data block only for the mobile station sending the message, and the decision whether to set to the value ACKED the corresponding element in  $V(B)$  indexed relative to SSN is implementation specific. If the bit contains the value '0', it negatively acknowledges the corresponding RLC data block only for the mobile station sending the message, and the decision whether to set to the value NACKED the corresponding element in  $V(B)$  indexed relative to SSN is implementation specific. A bit within the uncompressed bitmap whose corresponding BSN is not within the transmit window shall be ignored.

If the EOW bit in the PACKET UPLINK ACK/NACK, EGPRS PACKET DOWNLINK ACK/NACK, EGPRS PACKET DOWNLINK ACK/NACK TYPE 2, EGPRS PACKET DOWNLINK ACK/NACK TYPE 3, EGPRS PACKET DOWNLINK ACK/NACK DLMC or MBMS DOWNLINK ACK/NACK message has the value '1', then bitmap value '0' shall be assumed for all RLC blocks with a BSN value higher than the last entry in the bitmap but less than  $V(S)$  (i.e.  $[V(R) - 1 < BSN < V(S)]$  modulo SNS).

If the RLC transmitter is on the mobile station side, the bit in the bitmap contains the value '0' and the number of block periods between the end of the block period used for the last transmission of the corresponding RLC data block and the beginning of the block period containing the PACKET UPLINK ACK/NACK message is less than  $(\max(BS\_CV\_MAX, 1) - 1)$  (i.e. the RLC data block was recently (re)transmitted and thus can not be validly negatively acknowledged in this particular PACKET UPLINK ACK/NACK message), the element in  $V(B)$  shall not be modified. Similarly, if the RLC transmitter is on the network side and the RLC data block cannot be validly negatively acknowledged in this particular Packet Ack/Nack message the element in  $V(B)$  shall not be modified.

In the case of a PAN field, the bitmap shall be interpreted in the same way as for the case of PACKET UPLINK ACK/NACK, EGPRS PACKET DOWNLINK ACK/NACK, EGPRS PACKET DOWNLINK ACK/NACK TYPE 2, EGPRS PACKET DOWNLINK ACK/NACK TYPE 3 or EGPRS PACKET DOWNLINK ACK/NACK DLMC message with the following exceptions:

- in the case when the PAN is received by the network, in RLC acknowledged mode, elements of  $V(B)$  shall not be set to ACKED; any element which would be set to ACKED shall be set to TENTATIVE\_ACK;
- in the case when the PAN is received by the mobile station, the contents of the reported bitmap shall be validated assuming a BS\_CV\_MAX value of 2, regardless of the value of the signalled BS\_CV\_MAX parameter;
- in the case when the PAN is received by the mobile station, the value "1" received in the reported bitmap shall not modify the current value of the corresponding element in  $V(B)$ ; the value "0" received in the reported bitmap shall set the corresponding element in  $V(B)$  to the value NACKED; in RLC acknowledged mode and when the BOW is set to the value "1" then all elements in  $V(B)$  corresponding to all blocks between  $V(A)$  and  $(SSN - 2)$  (modulo SNS) shall be set to the value TENTATIVE\_ACK;
- if the processing of a PAN would cause an element of  $V(B)$  to be changed from ACKED or TENTATIVE\_ACK to NACKED, the entire PAN field shall be ignored;

- if a PAN positively acknowledges a block which has not yet been transmitted (i.e. whose BSN is higher than or equal to V(S)) the entire PAN field shall be ignored;
- if a time-based PAN indicates a reserved value the entire PAN field shall be ignored.

NOTE: The last three conditions may arise due to undetected error in the PANI or in the PAN field.

## 9.1.9 Window Size

### 9.1.9.1 GPRS

For GPRS, the window size (WS) shall be 64.

### 9.1.9.2 EGPRS

A mobile station may support the use of the GPRS multislot class also for the EGPRS-GMSK only TBF mode. The support of this feature must be indicated as the "*Modulation based multislot class support*" information in the MS Radio Access Capability IE and the MS Radio Access Capability 2 IE.

A mobile station in EGPRS TBF mode not supporting the "*Modulation based multislot class support*" shall apply the EGPRS multislot class. A mobile station in EGPRS-GMSK only TBF mode shall apply the GPRS multislot class.

While a EGPRS-GMSK only TBF mode is in progress, if a mobile station receives DL blocks not coded with modulation and coding scheme MCS-1 to MCS-4 then the MS behavior is implementation specific.

For EGPRS the window size (WS) shall be set by the network according to the number of timeslots assigned in the direction of the TBF (uplink or downlink) using the applicable multislot capability except for the case of a DLMC configuration where the window size is determined by the buffer size supported (see Table 9.1.9.3.2). The allowed window sizes are given in table 9.1.9.2.1. Preferably, the selected window size should be the maximum, or follow the definition in annex I.

The window size may be set independently for each TBF on uplink and downlink. The mobile station shall support the maximum window size corresponding to its multislot capability. The selected WS shall be indicated within a PACKET UL/DL ASSIGNMENT, MULTIPLE TBF UL/DL ASSIGNMENT, PACKET TIMESLOT RECONFIGURE, MULTIPLE TBF TIMESLOT RECONFIGURE or PACKET CS RELEASE INDICATION message using the coding defined in table 9.1.9.2.1 except for the case of a DLMC configuration where the window size is determined by the buffer size supported (see Table 9.1.9.3.2).

Once a window size is selected for a given TBF, it may be changed to a larger size but not to a smaller size, in order to prevent dropping data blocks from the window.

In case the MS multislot class is not indicated during packet data connection establishment (access request for signalling message transfer), a default window size corresponding to the minimum window size for 1 timeslot (as defined in table 9.1.9.2.1) shall be selected.

In case a PACKET TIMESLOT RECONFIGURE or MULTIPLE TBF TIMESLOT RECONFIGURE message is sent to the mobile station without any window size for a specific TBF, then any previous value received for the specific TBF shall be used or, if no previous value has been received for the specific TBF, default window size shall be used.

NOTE: If a TBF is reallocated so that the number of assigned timeslots is reduced, the RLC window size may become larger than the maximum window size for the new resources.

**Table 9.1.9.2.1: Allowed window sizes in EGPRS TBF mode for different multislot allocations**

Window size	Coding	Timeslots assigned (multislot capability)							
		1	2	3	4	5	6	7	8



64	00000								
96	00001								
128	00010								
160	00011								
192	00100	Max							
224	00101								
256	00110		Max						
288	00111								
320	01000								
352	01001								
384	01010			Max					
416	01011								
448	01100								
480	01101								
512	01110				Max				
544	01111								
576	10000								
608	10001								
640	10010					Max			
672	10011								
704	10100								
736	10101								
768	10110						Max		
800	10111								
832	11000								
864	11001								
896	11010							Max	
928	11011								
960	11100								
992	11101								
1024	11110								Max
Reserved	11111	x	x	x	x	x	x	x	X
NOTE: The shaded cells represent the allowed window sizes.									

### 9.1.9.3 RLC buffer

A mobile station supporting multiple TBF or EMST shall support one RLC buffer per direction (uplink and downlink). The RLC buffer in a given direction represents the amount of physical memory the mobile station shall support in this direction for RLC PDUs from all RLC instances in the transmit (uplink) or receive (downlink) window(s). The RLC buffer size is given as the maximum number of RLC data blocks that can be stored in this buffer assuming the highest (modulation and) coding scheme supported by the mobile station in this direction. The RLC buffer shall be as follows:

- A mobile station supporting GPRS (not supporting EGPRS) shall support a RLC buffer of size 64 in both uplink and downlink directions
- A mobile station supporting EGPRS shall support RLC buffers as defined in the Table 9.1.9.3.1 below
- A mobile station in DLMC configuration shall support RLC buffers in the uplink as defined in Table 9.1.9.3.1 and RLC buffers in the downlink as defined in Table 9.1.9.3.2.

**Table 9.1.9.3.1: RLC buffer in a given direction for EGPRS capable MS**

	Maximum amount <i>N</i> of timeslots the MS supports in this direction (see note 1)							
	1	2	3	4	5	6	7	8
<b>RLC buffer size <i>S</i></b> (see note 2)	192	256	384	512	640	768	896	1024
NOTE 1: See 3GPP TS 45.002 for multislot classes								
NOTE 2: An EGPRS capable mobile station able to support up to <i>N</i> timeslots in a direction shall support an RLC buffer in this direction that can store <i>S</i> RLC data blocks								

**Table 9.1.9.3.2: Downlink RLC buffer for MS in DLMC Configuration**

	Maximum number of downlink timeslots supported (see note 1)			
	6 - 20	21 - 26	27 - 32	More than 32
<b>RLC buffer size <i>S</i></b> (see note 2)	1024	2048	3072	4096
NOTE 1: See <i>MS Radio Access Capability</i> IE in 3GPP TS 24.008				
NOTE 2: A mobile station that supports up to <i>N</i> downlink timeslots in DLMC configuration shall support an RLC buffer that can store <i>S</i> RLC data blocks				

NOTE: The sum of the RLC window sizes of all RLC instances running in the mobile station in a given direction may be larger than the mobile station's RLC buffer in this direction. The RLC buffer does not affect the allocation of RLC window size.

### 9.1.10 Compression

The compression algorithm is as follows. If the window size is less than the number of bits available for the bitmap, then full feedback is provided using an uncompressed bitmap. If the window size is larger than the number of bits available for the bitmap, then one-dimensional run length coding (based on ITU-T Recommendation T.4) is carried out starting at SSN.

The T.4 procedure for encoding run lengths is as follows. Runs of ones and zeros alternate, and the run lengths are represented by the code words listed in the tables below. The code words for run lengths of zeros and ones are as described in T.4 except for one minor modification: the terminating code words used for indicating run lengths of 1 zero and 3 zeros are interchanged. This modification helps in achieving some throughput improvement when frequency hopping is carried out. The run length code words are of two types: terminating code words and make-up code words. Each run length is represented by either one terminating code word or one make-up code word followed by a terminating code word. Run lengths in the range 0-63 bits are encoded with their appropriate terminating code word. Run lengths greater than 63 bits are encoded first by the make-up code word which is equal to or shorter than that required. This is then followed by the terminating code word representing the difference between the required run length and the run length represented by the make-up code.

No special code words are used either at the beginning of the bitmap or the end of a bitmap. A one bit indicator (i.e. Compressed Bitmap Starting Color Code) is used to indicate whether the compressed bitmap starts with a run length of zeros or a run length of ones.

The compressed bitmap is assumed to be of length  $L_c$  (see clause 12) bits. The run length encoder output is used only if a compression gain is realized; otherwise an uncompressed partial bitmap is transmitted. The compressed portion of the bitmap must end on a T.4 code word boundary which may or may not coincide with the number of bits available. In such cases, one possible implementation is to recognize the boundary of the last valid T.4 code word that fits into the available space as the end of the compressed bitmap. The rest of the bitmap is assumed to be uncompressed; the uncompressed portion of the bitmap has variable length (see clause 12). Any bits representing sequence numbers  $V(R)$  or beyond in either the compressed or uncompressed portion of the bitmap must be set to 0. Implementations may use other schemes to determine the boundary between the compressed and uncompressed portions of the bitmap.

**Table 9.1.10.1: Terminating codes (reproduced from ITU-T Recommendation T.4);  
T.4 code words used for representing run lengths of 1 zero and 3 zeros are interchanged**

One run length	Code word	Zero run length	Code word
0	00110101	0	0000110111
1	000111	1	10
2	0111	2	11
3	1000	3	010
4	1011	4	011
5	1100	5	0011
6	1110	6	0010
7	1111	7	00011
8	10011	8	000101
9	10100	9	000100
10	00111	10	0000100
11	01000	11	0000101
12	001000	12	0000111
13	000011	13	00000100
14	110100	14	00000111
15	110101	15	000011000
16	101010	16	0000010111
17	101011	17	0000011000
18	0100111	18	0000001000
19	0001100	19	00001100111
20	0001000	20	00001101000
21	0010111	21	00001101100
22	0000011	22	00000110111
23	0000100	23	00000101000
24	0101000	24	00000010111
25	0101011	25	00000011000
26	0010011	26	000011001010
27	0100100	27	000011001011
28	0011000	28	000011001100
29	00000010	29	000011001101
30	00000011	30	000001101000
31	00011010	31	000001101001
32	00011011	32	000001101010
33	00010010	33	000001101011
34	00010011	34	000011010010
35	00010100	35	000011010011
36	00010101	36	000011010100
37	00010110	37	000011010101
38	00010111	38	000011010110
39	00101000	39	000011010111
40	00101001	40	000001101100
41	00101010	41	000001101101
42	00101011	42	000011011010
43	00101100	43	000011011011
44	00101101	44	000001010100
45	00000100	45	000001010101
46	00000101	46	000001010110
47	00001010	47	000001010111
48	00001011	48	000001100100
49	01010010	49	000001100101
50	01010011	50	000001010010
51	01010100	51	000001010011
52	01010101	52	000000100100
53	00100100	53	000000110111
54	00100101	54	000000111000
55	01011000	55	000000100111
56	01011001	56	000000101000
57	01011010	57	000001011000
58	01011011	58	000001011001
59	01001010	59	000000101011
60	01001011	60	000000101100
61	00110010	61	000001011010
62	00110011	62	000001100110

One run length	Code word	Zero run length	Code word
63	00110100	63	000001100111

**Table 9.1.10.2: Make-up codes  
(reproduced from ITU-T Recommendation T.4)**

One run length	Code word	Zero run length	Code word
64	11011	64	0000001111
128	10010	128	000011001000
192	010111	192	000011001001
256	0110111	256	000001011011
320	00110110	320	000000110011
384	00110111	384	000000110100
448	01100100	448	000000110101
512	01100101	512	0000001101100
576	01101000	576	0000001101101
640	01100111	640	0000001001010
704	011001100	704	0000001001011
768	011001101	768	0000001001100
832	011010010	832	0000001001101
896	011010011	896	0000001110010
960	011010100	960	0000001110011

### 9.1.11 Segmentation of upper layer PDUs into RLC data units

Segmentation of upper layer PDUs is supported to allow transport of upper layer PDUs larger than the data field of a single RLC data block. If the contents of an upper layer PDU do not fill an integer number of RLC data blocks, the beginning of the next upper layer PDU shall be placed within the final RLC data block of the first upper layer PDU, with no padding or spacing between the end of the first upper layer PDU and the beginning of the next. If the final upper layer PDU in the TBF does not fill an integer number of RLC data blocks, filler octets shall be used to fill the remainder of the RLC data block.

The received (and segmented) upper layer PDUs shall be put into RLC data blocks in the same order as they are received from higher layers, except if resource reallocation for an uplink TBF is needed as described in sub-clause 8.1.1.1.2. A Block Sequence Number (BSN) is included in the header of each RLC data block to number the RLC data block. The RLC data blocks are to be numbered consecutively, modulo SNS, to allow re-assembly of the upper layer PDUs on the receiving side.

If EMSR is enabled, the transmission of an upper layer PDU may be suspended to transmit one or more upper layer PDUs of a higher priority. Once all higher priority upper layer PDUs have been transmitted, the transmission of the lower priority upper layer PDU can be resumed. The transition between two upper layer PDUs resulting from this suspend-resume function is described in sub-clause 10.4.14a.

In GPRS TBF mode, once an RLC data block has been transmitted over the physical link, should it be necessary to re-transmit the RLC data block, it shall be re-transmitted using the same channel coding scheme, BSN, and CV as it had in the previous transmission.

In EGPRS TBF mode, once an RLC data block has been transmitted over the physical link, should it be necessary to re-transmit the RLC data block, it shall be re-transmitted using the same BSN and the same calculated CV as were used in the previous transmission. The modulation and coding scheme may be changed following the procedures described in sub-clause 9.3.2.1.

### 9.1.12 Re-assembly of upper layer PDUs from RLC data units

RLC data blocks shall be collected at the receiver until all RLC data blocks comprising an upper layer PDU have been received. The RLC headers shall be removed from each RLC data block at this time and the RLC data units re-assembled into an upper layer PDU and passed to the next higher layer. In *A/Gb mode*, the size of the upper layer PDU delivered to the higher layer shall not exceed 1560 octets. Any octet received beyond this maximum limit and until the next identified upper layer PDU boundary shall be discarded.

During RLC acknowledged mode operation, received upper layer PDUs shall be delivered to the higher layer in the order in which they were originally transmitted.

During RLC unacknowledged mode operation, received upper layer PDUs shall be delivered to the higher layer in the order in which they are received.

During RLC non-persistent mode operation, received upper layer PDUs shall be delivered to the higher layer in the order in which they were originally transmitted. Nevertheless, since some RLC data units may not be received, some upper layer PDUs may be re-assembled and delivered to the higher layer erroneously. The receiving RLC endpoint shall use RLC data units up to the one characterized by  $BSN = V(Q) - 1$  when reassembling upper layer PDUs, even if some RLC data units are missing.

If EMSR is enabled, the transmission of an upper layer PDU may be suspended to transmit one or more upper layer PDUs of a higher priority and resumed thereafter. The transition between two upper layer PDUs resulting from this suspend-resume function is described in sub-clause 10.4.14a.

Fill bits having the value "0" shall be substituted for RLC data units not received. However, in EGPRS TBF mode, for erroneous RLC data blocks for which the header is correctly received, the output from decoder shall be delivered to the higher layer. The number of fill bits substituted shall be determined using Tables 9.1.12.a, 9.1.12.b, 9.1.12.c, 9.1.12.d, 9.1.12.e, 9.1.12.f. In the uplink direction the channel coding scheme shall be the commanded channel coding scheme. In the downlink direction the channel coding scheme shall be the channel coding scheme of the last correctly received RLC data block. If no RLC data blocks have been correctly received, by the mobile station the requested channel coding scheme shall be used. If no requested channel coding scheme has been sent to the network, the mobile station shall use the number of fill bits for CS-1.

**Table 9.1.12.a: RLC unacknowledged mode fill bits (GPRS)**

Channel Coding Scheme	Number of fill bits
CS-1	160
CS-2	240
CS-3	288
CS-4	400

**Table 9.1.12.b: RLC unacknowledged mode fill bits (EGPRS)**

Channel Coding Scheme	Number of fill bits
MCS-1	176
MCS-2	224
MCS-3 with padding	248
MCS-3	296
MCS-4	352
MCS-5	448
MCS-6 with padding	544
MCS-6	592
MCS-7	448
MCS-8	544
MCS-9	592

**Table 9.1.12.c: RLC unacknowledged mode fill bits (EGPRS2-A downlink)**

Channel Coding Scheme	Number of fill bits
MCS-2 with padding	208
DAS-5	448
DAS-6	544
DAS-7	656
DAS-8	448
DAS-9	544
DAS-10	656
DAS-11	544
DAS-12	656

NOTE: MCS-1, MCS-2 (with or without padding), MCS-3 (with or without padding), MCS-4, MCS-6, MCS-7 and MCS-8 are also used for EGPRS2-A downlink (see sub-clause 5.2.1). For these modulation and coding schemes, fill bits are defined in Table 9.1.12.b unless specified otherwise.

**Table 9.1.12.d: RLC unacknowledged mode fill bits (EGPRS2-B downlink)**

Channel Coding Scheme	Number of fill bits
DBS-5	448
DBS-6	592
DBS-7	448
DAS-10 with padding	592
DBS-8	592
DBS-9	448
DAS-12 with padding	592
DBS-10	592
DBS-11	544
DBS-12	592

NOTE: MCS-1, MCS-2, MCS-3 (with or without padding), MCS-4, MCS-6 to MCS-9, DAS-5, DAS-6, DAS-8, DAS-9, DAS-10 with padding, DAS-11 and DAS-12 with padding are also used for EGPRS2-B downlink (see sub-clause 5.2.1). For these modulation and coding schemes, fill bits are defined in Table 9.1.12.b and Table 9.1.12.c. unless specified otherwise.

**Table 9.1.12.e: RLC unacknowledged mode fill bits (EGPRS2-A uplink)**

Channel Coding Scheme	Number of fill bits
MCS-3 with padding	216
MCS-6 with padding	512
UAS-7	448
UAS-8	512
UAS-9	592
UAS-10	448
UAS-11	512

NOTE: MCS-1, MCS-2, MCS-3 (with or without padding), MCS-4, MCS-5 and MCS-6 (with or without padding) are also used for EGPRS2-A uplink (see sub-clause 5.2.1). For these modulation and coding schemes, fill bits are defined in Table 9.1.12.b unless specified otherwise.

**Table 9.1.12.f: RLC unacknowledged mode fill bits (EGPRS2-B uplink)**

Channel Coding Scheme	Number of fill bits
UBS-5	448
UBS-6 with padding	544
UBS-6	592
UBS-7	448
UBS-8 with padding	544
UBS-8	592
UBS-9	448
UBS-10 with padding	544
UBS-10	592
UBS-11	544
UBS-12	592

NOTE: MCS-1 to MCS-4 are also used for EGPRS2-B uplink (see sub-clause 5.2.1). For these modulation and coding schemes, fill bits are defined in Table 9.1.12.b unless specified otherwise.

### 9.1.12a Segmentation of RLC/MAC control messages into RLC/MAC control blocks

The network may segment RLC/MAC control messages into one, two or up to nine RLC/MAC control blocks depending on the length of the RLC/MAC control message. Segmentation of an RLC/MAC control message into more than two RLC/MAC control blocks is referred to as extended RLC/MAC control message segmentation. Extended RLC/MAC control message segmentation shall not be used for an RLC/MAC control message that can be sent using one or two RLC/MAC control blocks. Unless explicitly stated otherwise, extended RLC/MAC control message segmentation shall not be used. If the contents of a control message do not fit an integer number of control blocks, filler octets shall be used to fill the remainder of the RLC/MAC control block. Only the last RLC/MAC control block containing elements of the control message shall contain filler octets. The Final Segment (FS) bit of the RLC/MAC control block header shall be set according to whether the RLC/MAC control block contains the final segment of an RLC/MAC control message, except in case of extended RLC/MAC control message segmentation in which case the FS bit shall always be set to "0". In case of extended RLC/MAC control message segmentation, the Final Segment extension (FSe) bit of the RLC/MAC control block header (included in the second RLC/MAC control block onwards) shall be set according to whether the RLC/MAC control block contains the final segment of an RLC/MAC control message (see sub-clauses 10.4.9e and 10.4.12b).

The mobile station shall not segment RLC/MAC control messages.

NOTE: In order to provide the mobile station a Power Reduction value in a RLC/MAC control block, the network may use the segmentation mechanism although the RLC/MAC control block requires only one RLC/MAC control block to be transmitted. In that case the RBSN shall be set to '0' and FS shall be set to '1'.

### 9.1.12b Re-assembly of RLC/MAC control messages from RLC/MAC control blocks

RLC/MAC control blocks shall be collected at the receiver until all RLC/MAC control blocks comprising an RLC/MAC control message have been received.

In packet idle mode, the mobile station shall be capable of receiving eight RLC/MAC control messages in parallel. If the mobile station receives RLC/MAC control blocks containing part of a ninth RLC/MAC control message while it still has RLC/MAC control blocks for eight partially received RLC/MAC control messages, the mobile station shall discard the RLC/MAC control blocks of the oldest partially received message.

In packet transfer mode, the mobile station shall be capable of receiving two RLC/MAC control messages in parallel on the same PDCH. If the mobile station receives RLC/MAC control blocks containing part of a third RLC/MAC control message while it still has RLC/MAC control blocks for two partially received RLC/MAC control messages, the mobile station shall discard the RLC/MAC control block of the oldest partially received message.



The mobile station shall start an instance of timer T3200 following the receipt of an RLC/MAC control block whose RTI value does not correspond to the RTI value of a partially received RLC/MAC control message or if the RLC/MAC control blocks were received on different PDCHs. In non-DRX mode the duration of timer T3200 shall be four BS\_CV\_MAX block periods. In DRX mode the duration of timer T3200 shall be four times the DRX period (see 3GPP TS 43.064).

On receipt of an RLC/MAC control block containing a segment of an RLC/MAC control message such that the mobile station still does not have the complete RLC/MAC control message, the mobile station shall restart the corresponding instance of timer T3200.

On receipt of an RLC/MAC control block containing a segment of an RLC/MAC control message such that the mobile station now has the complete RLC/MAC control message, the mobile station shall stop the corresponding instance of timer T3200.

If the mobile station discards a partially received RLC/MAC control message while the corresponding instance of timer T3200 is running, the mobile station shall stop the corresponding instance of timer T3200.

On expiry of an instance of timer T3200, the mobile station shall discard and ignore all segments of the corresponding partially received RLC/MAC control message.

Upon successful change of PDCH allocation, the mobile station shall discard all partially received RLC/MAC control messages and stop the corresponding instances of timer T3200.

The mobile station shall discard any control message segment that contains an unknown TFI.

### 9.1.13 Priority of upper layer PDUs

The mobile station shall not transmit upper layer PDUs during a TBF that have a lower Radio Priority than the priority that was used at initial access or the priority sent in the last PACKET RESOURCE REQUEST message, except if the upper layer PDUs at the higher Radio Priority does not completely fill the RLC data block (see sub-clause 8.1.1.1.2). The mobile station may change the Radio Priority of an uplink TBF by sending a PACKET RESOURCE REQUEST message to the network (see sub-clause 8.1.1.1.2).

### 9.1.14 Fast Ack/Nack Reporting

#### 9.1.14.1 General

The Fast Ack/Nack reporting procedure (FANR) allows to piggy-back, within EGPRS RLC/MAC blocks for data transfer sent in one direction, the acknowledgement status of data blocks relative to a TBF in the opposite direction. The acknowledgement status is provided with a Piggy-backed Ack/Nack (PAN) field of which the presence within an EGPRS RLC/MAC block for data transfer is indicated with the PANI field within the RLC/MAC header of that block, see sub-clause 10.4.21.

The activation of FANR for a given TBF is signalled by the network at TBF establishment/reconfiguration. The mobile station shall proceed as follows:

- If a downlink TBF is established or reconfigured with FANR activated (see sub-clauses 11.2.7, 11.2.7a, 11.2.31, and 11.2.31a), the mobile station shall act upon sub-clauses 9.1.14.2 and 9.1.14.3. The mobile station shall always use the SSN-based encoding defined in subclause 9.1.8 to encode the PAN field. The RLC data blocks pertaining to a downlink TBF for which FANR is activated shall always be encoded using the relevant RLC/MAC header form specified in sub-clause 10.3a.3 (i.e. PANI and CES/P fields present) irrespective of the existence of a concurrent TBF in the uplink direction.
- If an uplink TBF is established or reconfigured with FANR activated (see sub-clauses 11.2.29, 11.2.29a, 11.2.31, and 11.2.31a), the mobile station shall monitor for the presence of a PAN field for this TBF on all downlink PDCHs on which it shall monitor the USF for this TBF. The mobile station shall only attempt to decode a PAN field in a downlink EGPRS RLC/MAC block for data transfer if it is already required to check for a USF within that RLC/MAC block. If the presence of a PAN field is indicated in the header of an EGPRS RLC/MAC block for data transfer received on these PDCHs, the mobile station shall attempt to decode the PAN field also in the blocks addressed to other mobile stations. The network may encode the PAN field according to the SSN-based encoding defined in subclause 9.1.8 or the time-based encoding defined in subclause 9.1.15. The specific encoding selected by the network is notified to the mobile station at TBF establishment/reconfiguration (see sub-

clauses 11.2.29, 11.2.29a, 11.2.31, and 11.2.31a) and, if multiple TBFs procedures are supported, it shall be the same for all the uplink TBF of the same mobile station. The decision for transmitting a PAN field by the network is implementation specific.

- If the PAN is addressed to a different mobile station than the one to which the data in the RLC/MAC block carrying the PAN is addressed, the same restrictions for the network's selection of the modulation and coding scheme apply as for the USF transmission to this MS, see sub-clause 5.2.4a (except for MCS-4 and MCS-9 which cannot carry a PAN).

NOTE 1: FANR is supported only on full-rate PDCH and PDCH-pair.

NOTE 2: If the network does not have any EGPRS RLC/MAC blocks for data transfer in downlink direction but a downlink PAN field is available for transmission to a mobile station operating in A/Gb mode, the network may use an LLC UI Dummy command (see 3GPP TS 44.064) to create an EGPRS RLC/MAC data block where the PAN field available for transmission can be sent.

NOTE 3: FANR can be activated for a TBF operated in RLC unacknowledged mode.

The network shall activate FANR for any assigned TBF which uses an RTTI or MTTI configuration.

### 9.1.14.2 Polled Fast Ack/Nack Reporting

Polled FANR may be used together with event-based FANR (see sub-clause 9.1.14.3).

If the RLC endpoint transmitter is the network and the mobile station has at least one concurrent TBF in the uplink direction, the network may poll the mobile station to trigger the FANR procedure. In this case the mobile station shall answer in a reserved radio block period which is allocated with the polling as described in sub-clause 8.1.2.2.

In the case where the network polls for a PAN and the mobile station does not transmit a PAN (e.g. because it does not have any EGPRS RLC/MAC blocks for data transfer in the uplink direction, all the elements of V(B) have the value TENTATIVE\_ACK or ACKED, does not have any TBF assigned in the uplink direction or does not have an uplink TBF that has been assigned a PDCH corresponding to the downlink PDCH where the poll was received or a PDCH-pair corresponding to the downlink PDCH-pair where the poll was received), the mobile station shall transmit an EGPRS PACKET DOWNLINK ACK/NACK, EGPRS PACKET DOWNLINK ACK/NACK TYPE 2, EGPRS PACKET DOWNLINK ACK/NACK TYPE 3 or EGPRS PACKET DOWNLINK ACK/NACK DLMC message containing NPB, see sub-clause 10.4.4b.

### 9.1.14.3 Event-based Fast Ack/Nack Reporting

Event-based FANR may be used together with Polled FANR (see sub-clause 9.1.14.2).

If the RLC endpoint receiver is the mobile station, event-based FANR is enabled for this TBF and the mobile station has at least one assigned TBF in the uplink direction, the mobile station shall insert one PAN field in an EGPRS RLC/MAC block for data transfer transmitted during a given radio block period for that uplink TBF if the state of any element in the receive state array V(N) is UNREPORTED and that element will not otherwise be reported (e.g. in response to a poll) during the radio block period. In addition, the mobile station may insert one PAN field in an EGPRS RLC/MAC block for data transfer transmitted during a given radio block period even if that element will be reported in response to a poll during the radio block period.

The mobile station may continue to insert PAN fields in subsequent EGPRS RLC/MAC data blocks sent in the same radio block period as long as there exists one or more elements in the receive state array V(N) whose state is UNREPORTED.

If event-based FANR is enabled and the network polls the mobile station, the mobile station shall transmit, in the reserved radio block period which is allocated with the polling, one of the messages as described in sub-clause 8.1.2.2.

If the mobile station does not have any RLC data block waiting for the transmission, the mobile station shall transmit an EGPRS PACKET DOWNLINK ACK/NACK, EGPRS PACKET DOWNLINK ACK/NACK TYPE 2, EGPRS PACKET DOWNLINK ACK/NACK TYPE 3 or EGPRS PACKET DOWNLINK ACK/NACK DLMC message containing NPB.

In case of multiple-TBF allocation or if multiple RLC entities are multiplexed within a single TBF by means of EMST, a mobile station shall insert a PAN field indicating unreported erroneous RLC data blocks from TBFs, or in case of

EMST, from an RLC entity in RLC non-persistent mode prior to a PAN field indicating unreported erroneous RLC data blocks from TBFs, or in case of EMST, from an RLC entity in RLC acknowledged mode.

## 9.1.15 Time-based encoding of the Piggy-backed Ack/Nack field

### 9.1.15.1 Generation of the bitmap

When the time-based encoding is used (see sub-clause 9.1.14.1), the Piggy-backed Ack/Nack (PAN) field included in a radio block transmitted by the network in a given basic (respectively reduced) radio block period shall contain a bitmap providing feedback information relative to the reception of radio blocks in basic (respectively reduced) TTI configuration at the network side, possibly from different mobile stations, in the previous basic (respectively reduced) radio block periods on a number of uplink PDCHs (respectively PDCH-pairs).

The network shall indicate at TBF establishment/reconfiguration (see sub-clauses 11.2.29, 11.2.29a, 11.2.31, and 11.2.31a) the timeslots for which feedback is provided and the time-shift TSH (expressed in number of TDMA frames) between the most recent radio block period for which feedback information is provided and the radio block period when the bitmap is sent. If the TBF operates in RTTI configuration or MTTI configuration, feedback shall be provided for an even number of timeslots (see sub-clause 12.18).

A variable number (between 1 and 3) of bits are used in the PAN field to notify the status of every reported radio block, as described in Table 9.1.15.1.1. For modulation and coding schemes where two RLC data blocks are transmitted within a single radio block, there is one RLC data block per "RLC data block group". For modulation and coding schemes where three RLC data blocks are transmitted within a single radio block, the first "RLC data block group" contains the first RLC data block and the second "RLC data block group" contains the second and third RLC data blocks. For modulation and coding schemes where four RLC data blocks are transmitted within a single radio block, the first "RLC data block group" contains the first two RLC data blocks and the second "RLC data block group" contains the third and fourth RLC data blocks. An RLC data block group containing two RLC data blocks shall be indicated as having been successfully decoded only if both constituent RLC data blocks have been successfully decoded.

**Table 9.1.15.1.1: Feedback information for every reported radio block**

Bit string	Meaning (radio block contains one RLC block)	Meaning (radio block contains two or more RLC blocks)
0 1 0	failed header decoding	- failed header decoding - header correctly received but failed decoding of the payload of both RLC data block groups
0 0	header correctly received but failed decoding of the payload of the RLC data block	header correctly received, successful decoding of the first RLC data block group, failed decoding of the second RLC data block group
0 1 1	reserved	header correctly received, successful decoding of the second RLC data block group, failed decoding of the first RLC data block group
1	header correctly received and successful decoding of the payload of the RLC data block	header correctly received and successful decoding of the payload of both RLC data block groups

For a PAN field transmitted in a given basic (respectively reduced) radio block starting with TDMA frame N, the first code in the bitmap shall refer to the radio block received on the first reported uplink PDCH (respectively PDCH-pair) starting with TDMA frame (N-TSH or N-TSH-1) mod 2715648, the second code shall refer to the radio block received on the second reported uplink PDCH (respectively PDCH-pair) starting with TDMA frame (N-TSH or N-TSH-1) mod 2715648, etc. If there is still space in the PAN field, then the next code shall refer to the radio block received on the first reported uplink PDCH (respectively PDCH-pair) starting with TDMA frame (N-TSH-4 or N-TSH-5) mod 2715648 for TBFs in basic TTI configuration (respectively TDMA frame (N-TSH-2 or N-TSH-3) mod 2715648 for TBFs in reduced TTI configuration) and so on.

In a PAN field included in a radio block transmitted in basic (respectively reduced) TTI configuration, the network shall include a bit string as specified in Table 9.1.15.1.1 for every PDCH (respectively PDCH-pair) covered by the report, even if no uplink radio block in basic (respectively reduced) TTI configuration was scheduled to be transmitted on that PDCH/PDCH-pair.

NOTE: For a PAN field included in a radio block transmitted in basic (respectively reduced) TTI configuration, bit strings shall be included in the positions corresponding to PDCHs (respectively PDCH-pairs) on which radio blocks in reduced (respectively basic) TTI configuration were scheduled.

In the case of a PAN field received within an RTTI block by a mobile station with an uplink MTTI configuration (see sub-clause 7.1.3.7) and which covers both the PDCH and one or more PDCH-pairs for that MTTI configuration, the network shall include the applicable bit string for the BTTI radio block in the first of the two positions which would otherwise be used for reporting the status of two uplink RTTI radio blocks sent using a PDCH-pair that includes that PDCH.

In the case of a PAN field received within a BTTI block by a mobile station with an uplink MTTI configuration (see sub-clause 7.1.3.7) and which covers both the PDCH and one or more PDCH-pairs for that MTTI configuration, the network shall include the applicable bit string for the later (respectively earlier) RTTI radio block in the first (respectively second) of the two positions which would otherwise be used for reporting the status of two uplink BTTI radio blocks sent using the PDCHs that comprise the PDCH-pair being reported.

If necessary, the PAN field may be padded using either one or two bits. If one bit of padding is required, then a '0' shall be used. If two bits is required, the bit string '0 1' shall be used.

### 9.1.15.2 Interpretation of the bitmap

If the time-based encoding is used, when a mobile station successfully decodes a PAN field in a radio block transmitted in basic (respectively reduced) TTI configuration it correlates the received feedback information, which may refer to the transmission of different mobile stations, with the knowledge of the RLC data blocks (i.e. the BSNs) it transmitted in a given basic (respectively reduced) radio block period on a given uplink PDCH (respectively PDCH-pair) during the time window covered by the PAN field. The mobile station shall then derive which RLC data blocks were correctly received or not by the network in that time window. In case of multiple TBFs in different TTI configurations the mobile station shall not derive any information for TBFs in basic (respectively reduced) TTI configuration from PAN fields included in radio blocks transmitted in reduced (respectively basic) TTI configuration. A mobile station assigned uplink resources in an MTTI configuration (see sub-clause 7.1.3.7) shall derive information for both RTTI radio blocks and BTTI radio blocks which are covered by the PAN field (see sub-clause 9.1.15.1).

If the final bit(s) in the bitmap do not correspond to any valid bitstring as specified in sub-clause 9.1.15.1, these bits shall be ignored.

Where it is indicated that the decoding of an RLC data block group failed, and that RLC data block group contained two RLC data blocks, then the mobile station shall consider that the decoding of both RLC data blocks failed.

For the RLC data blocks correctly received the corresponding elements in V(B) shall be set to the value ACKED.

For each RLC data block not correctly received the corresponding element in V(B) shall be set to the value NACKED, if the number of basic (respectively reduced) radio block periods between the end of the radio block period used for the last transmission of the corresponding RLC data block and the beginning of the radio block period containing the PAN field is higher or equal than  $(TSH/4)-1$  for TBFs in basic TTI configuration (respectively  $(TSH/2)-1$  for TBFs in reduced TTI configuration), i.e. the RLC data block was not recently (re)transmitted and thus can be validly negatively acknowledged by this particular PAN field, otherwise the corresponding element in V(B) shall not be modified.

## 9.2 Operation during RLC/MAC control message transfer

RLC/MAC control blocks shall be used to transport RLC/MAC control messages. Segments of only one RLC/MAC control message shall be transported per RLC/MAC control block.

RLC/MAC control blocks shall be sent at a higher priority than RLC data blocks.

The receiving side shall determine the length of the RLC/MAC control message contents by interpreting the RLC/MAC control block contents.

No general acknowledgement shall be made as part of the transfer of RLC/MAC control blocks or RLC/MAC control messages. The receiver shall not acknowledge an RLC/MAC control block except when a valid RRBP field is present in the MAC header of the RLC/MAC control block. The receiver shall not acknowledge an RLC/MAC control message except when the RLC/MAC procedures explicitly specify an acknowledgement.

Each downlink RLC/MAC control block header, if present, contains a Radio Transaction Identifier (RTI) field that is 5 bits in length and performs in effect a modulo 32 count of the downlink RLC/MAC control messages sent on a PDCH. The RTI field shall be used to group the RLC/MAC control blocks that make up an RLC/MAC control message. The RTI field allows the transmitting and receiving entities to distinguish between up to 32 RLC/MAC control messages in a single transmit direction therefore allowing up to 32 parallel transactions per PDCH.

The network shall not use the same RTI value at the same time on the same PDCH for two separate RLC/MAC control messages. The network may use the same RTI value at the same time on separate PDCHs. The network shall transmit all segments of a segmented control message on the same PDCH.

## 9.3 Operation during RLC data block transfer

### 9.3.0 General

The RLC ARQ functions support three modes of operation: RLC acknowledged mode, RLC unacknowledged mode and RLC non-persistent mode. RLC acknowledged mode operation uses retransmission of RLC data blocks to achieve high reliability. RLC unacknowledged mode operation does not utilize retransmission of RLC data blocks. RLC non-persistent mode operation uses non-exhaustive retransmission of RLC data blocks. A TBF may operate in either RLC acknowledged mode, RLC unacknowledged mode or RLC non-persistent mode. An MBMS bearer operates in RLC non-persistent mode.

The mobile station requests the RLC mode of the uplink TBF by setting the RLC\_MODE bit to either RLC acknowledged mode or RLC unacknowledged mode in the PACKET RESOURCE REQUEST or the (EGPRS) PACKET DOWNLINK ACK/NACK or EGPRS PACKET DOWNLINK ACK/NACK TYPE 2 or the EGPRS PACKET DOWNLINK ACK/NACK DLDC message. When the establishment cause field in the PACKET CHANNEL REQUEST message indicates "one phase access", the RLC mode defaults to RLC acknowledged mode. If both the mobile station and the BSS support multiple TBF procedures, or if the mobile station supports RLC non-persistent mode, the BSS may override the mobile station's indicated RLC mode, ordering its preferred RLC mode (including RLC non-persistent mode for EGPRS TBF(s), if the mobile station supports this RLC mode) when establishing uplink TBF(s) as follows:

- The network shall always set the RLC\_MODE bit for the uplink TBF(s) in the MULTIPLE TBF UPLINK ASSIGNMENT and MULTIPLE TBF TIMESLOT RECONFIGURE messages.
- The network may order the RLC mode for the uplink TBF by setting the RLC\_MODE bit in the PACKET UPLINK ASSIGNMENT message or the UPLINK\_RLC\_MODE bit in the PACKET TIMESLOT RECONFIGURE message. The mobile station shall assume that its indicated RLC mode is used if the BSS does not override it in the PACKET UPLINK ASSIGNMENT or PACKET TIMESLOT RECONFIGURE message.

The network sets the RLC mode of the downlink TBF by setting the RLC\_MODE bit in the PACKET DOWNLINK ASSIGNMENT, MULTIPLE TBF DOWNLINK ASSIGNMENT, PACKET TIMESLOT RECONFIGURE, MULTIPLE TBF TIMESLOT RECONFIGURE or PACKET CS RELEASE INDICATION message.

An uplink TBF may be operating in either non-extended uplink TBF mode or extended uplink TBF mode, see sub-clause 9.3.1b. An uplink TBF operating in RLC non-persistent mode shall operate in extended uplink TBF mode.

When one or more PDCH/Fs are used in conjunction with one PDCH/H in the same direction, the RLC/MAC data blocks may not be received in the same sequence they were sent, due to the different data rates of the channels. In RLC unacknowledged mode, the sending entity shall re-order the RLC/MAC data blocks before transmission to ensure their reception in sequence.

### 9.3.1 Countdown procedure

#### 9.3.1.1 General

The mobile station shall send the Countdown Value (CV) in each uplink RLC data block to indicate the current number of remaining RLC data blocks for the uplink TBF. In case EMST is used, the CV shall indicate the current number of remaining RLC data blocks for the corresponding RLC entity allocated to the uplink TBF.

The CV shall be calculated as follows:

$$\text{Let integer } x = \text{round}\left(\frac{TBC - BSN' - 1}{NTS \times K}\right).$$

$$\text{then, } CV = \begin{cases} x, & \text{if } x \leq BS\_CV\_MAX, \\ 15, & \text{otherwise.} \end{cases}$$

where:

- TBC = total number of RLC data blocks currently to be transmitted in the TBF.
- BSN' = absolute block sequence number of the RLC data block, with range from 0 to (TBC - 1).
- NTS = number of timeslots assigned to the uplink TBF in the assignment message, with range 1 to 8 when operating in BTTI configuration. In RTTI configuration this parameter shall be equal to the number of assigned uplink PDCH pairs, with the range 1 to 4. In an MTTI configuration, the parameter shall be equal to the number of uplink BTTI PDCHs assigned plus twice the number of RTTI PDCH-pairs assigned, with the range 3 to 7.
- K = 2 when commanded MCS is MCS-7, MCS-8, MCS-9, UAS-7, UAS-8, UAS-9, UBS-7 or UBS-8  
 3 when commanded UAS-10, UAS-11, UBS-9 or UBS-10  
 4 when commanded UBS-11 or UBS-12 otherwise K=1,  
 the function round() rounds upwards to the nearest integer.
- BS\_CV\_MAX is a parameter broadcast in the system information,  
 the division operation is non-integer and results in zero only for (TBC - BSN' - 1) = 0.

The countdown procedure starts when RLC data blocks include CV values different from '15'. When the mobile station transmits the last RLC data block currently in the send buffer for the TBF (i.e. the RLC data block with BSN' = TBC - 1), the RLC data block shall have CV set to the value '0'.

When an EGPRS or EGPRS2 RLC/MAC block for data transfer consists of two or more RLC data blocks, a CV value is calculated for each block and the CV of the RLC/MAC header refers to the last RLC data block.

### 9.3.1.2 Non-extended uplink TBF mode

In an uplink TBF operating in non-extended uplink TBF mode, the CV shall indicate the absolute BSN (BSN') of the last RLC data block that will be sent in the uplink TBF. The TBC value is the total number of RLC data blocks that will be transmitted in the TBF.

At the point in time the mobile station having an uplink TBF in non-extended TBF mode transmits the first RLC data block indicating a CV other than 15, the mobile station shall transmit afterwards exactly (TBC - BSN' - 1) untransmitted RLC data blocks.

If the mobile station receives a change in the Channel Coding Command in a PACKET UPLINK ACK/NACK message during the countdown procedure, the mobile station shall act upon the new Channel Coding Command. The mobile station shall then recalculate the CV for any untransmitted RLC data block using the new RLC data block size.

If the mobile station successfully completes the contention resolution procedure during one phase access and the countdown procedure is already running, the mobile station shall recalculate the CV for any untransmitted RLC data blocks.

Any data that arrives from the higher layer after the commencement of the countdown process shall be sent within a future TBF.

The mobile station may retransmit during the countdown in response to a Packet Ack/Nack or if stalled.

If the mobile station receives a new allocation during the countdown, the mobile station shall use this new allocation to the end of the countdown procedure. The network shall provide unsolicited uplink resources for any retransmissions that may be required.

### 9.3.1.3 Extended uplink TBF mode

In an uplink TBF operating in extended uplink TBF mode, the CV shall indicate the current number of RLC data blocks that has not been transmitted in the uplink TBF. The mobile station shall update the TBC value and recalculate the CV for any untransmitted RLC data block in the following cases:

- The RLC entity of the mobile station receives new data from upper layers for transmission in the uplink TBF.
- The mobile station completes the contention resolution at one-phase packet access.
- The mobile station changes the coding scheme of the RLC data blocks transmitted in an uplink TBF operating in GPRS TBF mode.
- The mobile station changes the modulation and coding scheme of the RLC data blocks transmitted in an uplink TBF operating in EGPRS TBF mode.

NOTE: Updating the TBC value shall not result in changing the CV of the RLC data blocks already transmitted, in the case they need to be retransmitted.

### 9.3.1a Delayed release of downlink Temporary Block Flow

When the network exhausts its supply of downlink data for a downlink TBF, it may release the TBF by using one of the procedures in sub-clause 9.3.2.6 or sub-clause 9.3.3.5. If a TBF is not instantly released, the network may continue the downlink TBF awaiting new data to be received from the upper layers. After a period of inactivity, the TBF shall be released at a point determined by the network, using one of the procedures in sub-clause 9.3.2.6, sub-clause 9.3.3.5 or sub-clause 8.1.2.8. Once the release of a downlink TBF is initiated, the TBF shall not be continued.

If the network continues a downlink TBF when the supply of downlink data is exhausted, the RLC entity on the network side shall insert filler information into the RLC data blocks that are transmitted to the mobile station. For a mobile station operating in *A/Gb mode*, this is achieved by the insertion of LLC UI Dummy commands (see 3GPP TS 44.064) into the TBF. For a mobile station operating in *Iu mode*, the network may directly transmit RLC data blocks with filler information by setting the LI field as described in sub-clauses 10.4.14 and 10.4.14a. The FBI bit in the RLC header shall be set to the value '0' unless the network releases the TBF, in which case the FBI bit shall be set to the value 1.

If new data is received from the upper layers, the network stops sending filler information and resumes normal operation during RLC data block transfer.

RLC data blocks shall be sent to the mobile station as required to prevent the expiry of timer T3190 for each TBF, according to power control requirements, and as needed to poll the mobile station for the provision of PACCH uplink blocks.

NOTE: Extensive delay of a downlink TBF release might impact badly on the mobile station power consumption and should be avoided. Inactivity periods should not be longer than necessary to keep the overall performance of GPRS services. Inactivity periods longer than 5 s should not be used unless the DTR mode is used, see sub-clause 8.1.8.

### 9.3.1b Extended uplink TBF mode

#### 9.3.1b.1 Application

Network support of the extended uplink TBF mode shall be indicated by the NW\_EXT\_UTBF parameter that is broadcast on either BCCH or PBCCH, see sub-clause 12.24. A network which supports RLC non-persistent mode shall support extended uplink TBF mode. A network which supports Enhanced Flexible Timeslot Assignment, EFTA, shall support extended uplink TBF mode.

The mobile station shall support the extended uplink TBF mode. The extended uplink TBF mode is a part of the *GERAN Feature Package 1*. A mobile station indicating support of *GERAN Feature Package 1* in the Mobile Station Classmark 3 IE, the MS Radio Access Capability IE and the MS Radio Access Capability 2 IE supports the extended uplink TBF mode (see 3GPP TS 24.008).

The RLC/MAC entity, which has received the indication that the peer supports the extended uplink TBF mode, shall operate an uplink TBF in the extended uplink TBF mode.

NOTE: The network might not receive the radio access capabilities of the mobile station at one-phase packet access. In that case, the two entities may operate in different mode.

### 9.3.1b.2 Operation of uplink TBF in extended uplink TBF mode

In extended uplink TBF mode, an uplink TBF may be maintained during temporary inactive periods, where the mobile station has no RLC information to send.

During the temporary inactive periods, the mobile station may stop sending RLC data block, as defined in sub-clause 9.1.3. The network shall continue allocating the mobile station uplink radio blocks during the inactivity period, using the procedures defined in sub-clause 8.1.1 for each medium access mode. Uplink radio blocks shall be allocated as required allowing the mobile station to continue the transfer of RLC data blocks, when a new RLC data block becomes available.

When the mobile station is allocated an uplink radio block and there is no RLC data block ready to send for any TBF, the mobile station shall send an RLC/MAC control block in each uplink radio block allocated by the network, unless indicated otherwise. When the mobile station is allocated an uplink radio block, and there is no RLC/MAC block for data transfer to send for this TBF but, in case of multiple TBFs, there is an RLC/MAC block for data transfer to send for one or more other TBF(s) assigned on the same PDCH, the mobile station should send an RLC/MAC block for data transfer from one of these other TBF(s) in the allocated uplink radio block indicating the TFI of that other TBF in the RLC/MAC header of that RLC/MAC block. The priorities defined in sub-clause 8.1.1 for different kinds of RLC/MAC blocks apply. The network may allow, via the EXT\_UTBF\_NODATA parameter broadcast in GPRS Cell Options IE (see sub-clause 12.24), any mobile station during extended uplink TBF mode not to send any PACKET UPLINK DUMMY CONTROL BLOCK message when there is no other RLC/MAC block ready to send. A mobile station during extended uplink TBF mode may refrain from sending PACKET UPLINK DUMMY CONTROL BLOCK messages when there is no other RLC/MAC block ready to send only if so indicated by the EXT\_UTBF\_NODATA parameter.

During a period when the network does not receive any RLC data blocks from the mobile station, the network may periodically send a PACKET UPLINK ACK/NACK message to the mobile station. When applicable, depending on the medium access mode, the PACKET UPLINK ACK/NACK message shall be sent as required to prevent timer T3184 from expiring.

The network determines the release of an uplink TBF. The network releases an uplink TBF using the procedure in sub-clause 9.5 (*A/Gb mode*) or 3GPP TS 44.160 (*Iu mode*).

NOTE 1: An uplink TBF may be released also by procedures defined in clause 8.

NOTE 2: Extensive delay of an uplink TBF release whilst the mobile station does not send any RLC information might impact badly on the mobile station power consumption and should be avoided. Inactivity periods should not be longer than necessary to keep the overall performance of GPRS services. Inactivity periods longer than 5 s should not be allowed unless the DTR mode is used, see sub-clause 8.1.8. If, however, the network has indicated that the mobile station during extended uplink TBF mode is not required to send PACKET UPLINK DUMMY CONTROL BLOCK messages, as described above, and the mobile station makes use of this option, the impact on the mobile station power consumption will be less critical and longer inactivity periods than 5 seconds can be allowed.

NOTE 3: Enhanced Flexible Timeslot Assignment, EFTA, is applicable only if the network has indicated that the mobile station during extended uplink TBF mode is not required to send PACKET UPLINK DUMMY CONTROL BLOCK messages as described above.

## 9.3.2 Acknowledged mode operation

### 9.3.2.0 General

The transfer of RLC data blocks in the RLC acknowledged mode uses retransmissions of RLC data blocks. The transmitting side numbers the RLC data blocks via the block sequence number (BSN). The BSN is used for retransmission and for reassembly. The receiving side sends Packet Ack/Nack messages in order to request retransmission of RLC data blocks.



### 9.3.2.1 Additional functionality in acknowledged EGPRS TBF Mode

In EGPRS TBF mode, the transfer of RLC Data Blocks in the acknowledged RLC/MAC mode may be controlled by a selective type I ARQ mechanism, or by type II hybrid ARQ (Incremental Redundancy: IR) mechanism, coupled with the numbering of the RLC Data Blocks within one Temporary Block Flow.

According to the link quality, an initial Modulation and Coding Scheme (MCS) is selected for an RLC block (see note). For the retransmissions, the same or another MCS from the same family of MCSs may be selected. E.g. if MCS-7 is selected for the first transmission of an RLC block, any MCS of the family B may be used for the retransmissions. Further, RLC data blocks initially transmitted with any MCS other than MCS-1, MCS-2 or MCS-3, may be retransmitted with MCS-1, MCS-2 or MCS-3 as appropriate, by sending the different parts of the RLC data block in different radio blocks. In this case, the SPB field in the header shall be set to indicate that the RLC data block is split, and which part of the RLC data block is retransmitted in the radio block.

For blocks initially transmitted with MCS-8 which are retransmitted using MCS-6 or MCS-3, for blocks initially transmitted with DAS-6, DAS-9, DAS-11 or DBS-11 which are retransmitted using MCS-3 and for blocks initially transmitted with UBS-11 which are retransmitted using UBS-10, UBS-8, UBS-6 or MCS-3, padding with all zeroes of the first six octets shall be applied. For blocks initially transmitted with UAS-8 or UAS-11 which are retransmitted using MCS-6 or MCS-3, padding with all zeroes of the first ten octets shall be applied. For blocks initially transmitted with DAS-7, DAS-10 or DAS-12 which are retransmitted using MCS-2, padding with all zeroes of the first two octets shall be applied. In all of these cases, the CPS and SPB fields shall be set accordingly. However, if the transmitter side is the mobile station and the RESEGMENT bit is not set, the mobile station shall use an MCS within the same family as the initial MCS without splitting the payload (refer to sub-clause 8.1.1, tables 8.1.1.2, 8.1.1.4 and 8.1.1.6) for retransmission.

In case an RLC data block originally transmitted using MCS-8 is retransmitted using two MCS-3 RLC/MAC blocks, the CPS and SPB fields of the first MCS-3 RLC/MAC block shall indicate MCS-3 with (6 octets) padding, whereas the CPS field of the second MCS-3 RLC/MAC block should indicate MCS-3 without padding. In case an RLC data block originally transmitted using DAS-6, DAS-9, DAS-11, DBS-11 or UBS-11 is retransmitted using two MCS-3 RLC/MAC blocks, the CPS and SPB fields of the first MCS-3 RLC/MAC block shall indicate MCS-3 with (6 octets) padding, whereas the CPS field of the second MCS-3 RLC/MAC block shall indicate MCS-3 without padding. In case an RLC data block originally transmitted using UAS-8 or UAS-11 is retransmitted using two MCS-3 RLC/MAC blocks, the CPS and SPB fields of the first MCS-3 RLC/MAC block shall indicate MCS-3 with (10 octets) padding, whereas the CPS field of the second MCS-3 RLC/MAC block shall indicate MCS-3 without padding. In case an RLC data block originally transmitted using DAS-7, DAS-10 or DAS-12 is retransmitted using three MCS-2 RLC/MAC blocks, the CPS field of the first MCS-2 RLC/MAC block shall indicate MCS-2 with (2 octets) padding whereas the CPS field of the remaining two MCS-2 RLC/MAC blocks shall indicate MCS-2 without padding.

The selection of MCS is controlled by the network.

The RLC data blocks shall first be sent with one of the initial code rates (i.e. the rate 1/3 encoded data is punctured with the Puncturing Scheme (PS) 1 of the selected MCS). If the RLC data block needs to be retransmitted, additional coded bits (i.e. the output of the rate 1/3 encoded data which is punctured with PS 2 of the prevailing MCS) shall be sent. If all the codewords (different punctured versions of the encoded data block) have been sent, the procedure shall start over and the first codeword (which is punctured with PS 1) shall be sent followed by PS 2 etc. RLC data blocks which are retransmitted using a new MCS shall at the first transmission after the MCS switch be sent with the puncturing scheme indicated in table 9.3.2.1.1.

**Table 9.3.2.1.1: RLC data blocks re-transmitted in new MCS**

MCS switched from	MCS switched to	PS of last transmission before MCS switch	PS of first transmission after MCS switch
MCS-9	MCS-6	PS 1 or PS 3	PS 1
		PS 2	PS 2
MCS-6	MCS-9	PS 1	PS 3
		PS 2	PS 2
MCS-7	MCS-5	any	PS 1
MCS-5	MCS-7	any	PS 2
all other combinations		any	PS 1

This procedure allows the receiver to operate either in type I or type II hybrid ARQ mode. In the type I ARQ mode, decoding of an RLC data block is solely based on the prevailing transmission (i.e. erroneous blocks are not stored). In the type II ARQ case, erroneous blocks are stored by the receiver and a joint decoding with new transmissions is done.

If the memory for IR operation run out in the mobile station, the mobile station shall indicate this by setting the MS OUT OF MEMORY bit in the EGPRS PACKET DOWNLINK ACK/NACK, EGPRS PACKET DOWNLINK ACK/NACK TYPE 2, EGPRS PACKET DOWNLINK ACK/NACK TYPE 3, EGPRS PACKET DOWNLINK ACK/NACK DLMC or MBMS DOWNLINK ACK/NACK message (see note). For uplink TBFs, the network may implicitly set the type I mode by ordering the mobile station to use a specific MCS and setting the RESEGMENT bit or type II mode by ordering the mobile station to use a specific MCS and not setting the RESEGMENT bit.

Type II hybrid ARQ is mandatory in EGPRS MS receivers and the associated performance requirements are specified in 3GPP TS 45.005. Furthermore, it is mandatory for an EGPRS MS receiver to be able to perform joint decoding among blocks with different MCSs if the combination of MCSs is one of the following:

- MCS-5 and MCS-7;
- MCS-6 and MCS-9.

Additionally if the mobile station supports EGPRS2-A in the downlink, it is mandatory for the mobile station to be able to perform joint decoding among blocks with different MCSs if the combination of MCSs is one of the following:

- DAS-5 and DAS-8;
- DAS-6, DAS-9 and DAS-11;
- DAS-7, DAS-10 and DAS-12;

and if the mobile station supports EGPRS2-B in the downlink, it is mandatory for the mobile station to be able to perform joint decoding among blocks with different MCSs if the combination of MCSs is one of the following:

- DBS-5, DBS-7, DBS-9, DAS-5 and DAS-8;
- DBS-6, DBS-8, DBS-10 and DBS-12;
- DBS-11, DAS-6, DAS-9 and DAS-11.

NOTE: The MCS selection may take the IR capability of the receiver into account, for example by using a less robust MCS for a given channel quality.

### 9.3.2.2 Establishment of Temporary Block Flow

The establishment of a TBF occurs as described in clause 7 and clause 8. RLC functions related to the ARQ function shall not operate until RLC data block transfer has been initiated.

If the last uplink TBF ended with an incompletely transmitted upper layer PDU or any unacknowledged upper layer PDUs, the mobile station shall begin transmission on the new TBF with the oldest unacknowledged upper layer PDU.

### 9.3.2.3 Operation of uplink Temporary Block Flow

The mobile station shall transmit an RLC/MAC block in each assigned uplink data block. RLC/MAC control blocks have preference to RLC data blocks, i.e. temporarily replacing the PDTCH with PACCH.

The network shall send PACKET UPLINK ACK/NACK messages when needed.

The mobile station shall indicate a transmit window stall condition when  $V(S) = V(A) + WS$ . Upon detecting a transmit window stall condition, the mobile station shall set the Stall indicator (SI) bit in all subsequent uplink RLC data blocks for this TBF, or if EMST is used, for the associated RLC entity, until the stall condition ceases to exist.

Upon detecting the stall condition the mobile station shall also start timer T3182 for the TBF, or if EMST is used, for the associated RLC entity. Timer T3182 shall be stopped upon reception of a PACKET UPLINK ACK/NACK message that makes  $V(S) < V(A) + WS$ . If timer T3182 expires, the mobile station shall decrement counter N3102 by PAN\_DEC, and proceed as follows:

- If there are no other ongoing uplink TBFs and one or no ongoing downlink TBFs perform an abnormal release with access retry (see sub-clause 8.7.2) (*A/Gb mode*) or 3GPP TS 44.160.
- If there are one or more other ongoing uplink TBFs or multiple ongoing downlink TBFs, perform a multiple TBF abnormal release with access retry (see sub-clause 8.7.4).

Whenever the mobile station receives a PACKET UPLINK ACK/NACK message that allows the advancement of  $V(S)$  or  $V(A)$ , the mobile station shall increment  $N3102$  by  $PAN\_INC$ , however  $N3102$  shall never exceed the value  $PAN\_MAX$ . Upon cell reselection the mobile station shall set counter  $N3102$  to the value  $PAN\_MAX$ . When  $N3102 \leq 0$  is reached, the mobile station shall perform an abnormal release with cell re-selection (see sub-clause 9.4.2). If  $PAN\_DEC$  or  $PAN\_INC$  is set to the value 0, counter  $N3102$  shall be disabled.

A mobile station operating with an exclusive allocation shall start or restart timer  $T3184$  upon reception of a PACKET UPLINK ACK/NACK message. If timer  $T3184$  expires, the mobile station shall perform an abnormal release with access retry (see sub-clause 9.4.2).

### 9.3.2.4 Release of uplink Temporary Block Flow

#### 9.3.2.4.1 General

In the non-extended uplink TBF mode, the mobile station initiates the release of the uplink TBF by beginning the countdown process (see sub-clause 9.3.1).

In the extended uplink TBF mode, the network determines when to release the uplink TBF. The release of an uplink TBF in the extended uplink TBF mode is performed by the procedure defined in sub-clause 9.5.

#### 9.3.2.4.2 Non-extended uplink TBF mode

When the mobile station has sent the RLC data block with  $CV = 0$  and there are no elements in the  $V(B)$  array set to the value *Nacked*, it shall start timer  $T3182$  for this TBF. The mobile station shall continue to send RLC data blocks on each assigned uplink data block, according to the algorithm defined in sub-clause 9.1.3.

If the network has received all RLC data blocks when it detects the end of the TBF (i.e. when  $CV=0$  and  $V(Q) = V(R)$ ), it shall send the PACKET UPLINK ACK/NACK message with the Final Ack Indicator bit set to '1', include a valid RRBP field in the RLC/MAC control block header and clear counter  $N3103$  for the TBF. The network may use the TBF Est field in the PACKET UPLINK ACK/NACK message to allow the mobile station to request the establishment of a new uplink TBF if there are no additional TBFs ongoing for that mobile station.

If the network has not received all of the RLC data blocks when it detects the end of the TBF, it shall send a PACKET UPLINK ACK/NACK message to the mobile station and if necessary allocate sufficient uplink resources for the mobile station to retransmit the required RLC data blocks.

Upon reception of a PACKET UPLINK ACK/NACK message for this TBF the mobile station shall stop timer  $T3182$  for the TBF.

If the PACKET UPLINK ACK/NACK message has the Final Ack Indicator bit set to '1' and the following conditions are fulfilled: TBF Est field is set to '1'; the mobile station has new data to transmit; the mobile station has no other ongoing downlink TBFs, the mobile station shall release the uplink TBF and may request the establishment of a new TBF using one of the following procedures:

- If Control Ack Type parameter in System Information indicates acknowledgement is access burst, the mobile station shall transmit the PACKET CONTROL ACKNOWLEDGEMENT message with the Ctrl Ack bits set to '00'. The mobile station shall start timer  $T3168$  for the TBF request and continue to monitor the PDCH used for transmitting the PACKET CONTROL ACKNOWLEDGEMENT message. The mobile station shall stop timer  $T3168$  for the TBF upon reception of the PACKET UPLINK ASSIGNMENT message including Single Block Allocation structure assigning resources for the TBF or the PACKET ACCESS REJECT message rejecting the TBF request. The mobile station shall use the same procedures as are used for TBF establishment using two phase access described in sub-clause 7.1.3 starting from the point where the mobile station receives the PACKET UPLINK ASSIGNMENT message including Single Block Allocation structure or the PACKET ACCESS REJECT message.
- If Control Ack Type parameter in System Information indicates acknowledgement is RLC/MAC control block, the mobile station shall transmit the PACKET RESOURCE REQUEST message and start timer  $T3168$  for the TBF request. The mobile station shall use the same procedures as are used for TBF establishment using two phase access described in sub-clause 7.1.3 starting from the point where the mobile station transmits the PACKET RESOURCE REQUEST message.

If the PACKET UPLINK ACK/NACK message has the Final Ack Indicator bit set to "1" and the mobile station does not initiate the establishment of a new uplink TBF according to one of the procedures described above, the mobile

station shall transmit the PACKET CONTROL ACKNOWLEDGEMENT message and release the TBF. If there is no other ongoing TBFs, the mobile station in packet transfer mode or MAC-Shared state shall return to packet idle mode or MAC-Idle state; the mobile station in dual transfer mode or MAC-DTM state shall return to dedicated mode or MAC-Dedicated state. The DRX mode procedures shall be applied as specified in sub-clause 5.5.1.5 and 3GPP TS 44.160. If there are one or more ongoing TBFs a mobile station shall remain in its current mode/state and can request additional uplink TBFs as follows:

- It may send a PACKET RESOURCE REQUEST message using the PACCH if there is at least one ongoing uplink TBF as described in sub-clause 8.1.1.1.2.
- It may include a Channel Request Description or the Extended Channel Request Description information element in the (EGPRS) PACKET DOWNLINK ACK/NACK or EGPRS PACKET DOWNLINK ACK/NACK TYPE 2 message or a Channel Request Description information element in the EGPRS PACKET DOWNLINK ACK/NACK DLMC message if there are no ongoing uplink TBFs and at least one ongoing downlink TBF as described in sub-clause 8.1.2.5.

If the PACKET UPLINK ACK/NACK message requests retransmission of RLC data blocks, the mobile station shall if necessary wait for allocation of uplink resources for this TBF and then retransmit the RLC data blocks requested. The mobile station shall then start timer T3182 for the TBF and wait for a PACKET UPLINK ACK/NACK message as above.

If timer T3182 expires for the TBF the mobile station shall perform an abnormal release with access retry (see sub-clause 8.7.2) (*A/Gb mode*) or 3GPP TS 44.160.

When the network receives the PACKET CONTROL ACKNOWLEDGEMENT message or the PACKET RESOURCE REQUEST message in the radio block indicated by the RRBp field, it may reuse the TFI and USF resources.

If the network receives the PACKET CONTROL ACKNOWLEDGEMENT message with Ctrl Ack bits set to '00' or the PACKET RESOURCE REQUEST message in the radio block indicated by the RRBp field and the network has set the TBF Est field to '1' in the PACKET UPLINK ACK/NACK message, the network shall follow one of the following procedures:

- In case the mobile station requested the establishment of new TBF with the PACKET CONTROL ACKNOWLEDGEMENT message, the network shall respond to the mobile station with the PACKET UPLINK ASSIGNMENT message including Single Block Allocation structure or the PACKET ACCESS REJECT message on the same PDCH as the mobile station has sent the PACKET CONTROL ACKNOWLEDGEMENT message. TLLI (in *A/Gb mode*) or the G-RNTI (in *Iu mode*) shall be used to identify the mobile station. The network shall use the same procedures as are used for TBF establishment using two phase access described in sub-clause 7.1.3 (*A/Gb mode*) or in 3GPP TS 44.160 starting from the point where the network transmits the PACKET UPLINK ASSIGNMENT message including Single Block Allocation structure or the PACKET ACCESS REJECT message.
- In case the mobile station requested the establishment of new TBF with the PACKET RESOURCE REQUEST message, the network shall use the same procedures as are used for TBF establishment using two phase access described in sub-clause 7.1.3 (*A/Gb mode*) or in 3GPP TS 44.160 starting from the point where the network has received the PACKET RESOURCE REQUEST message. TLLI (in *A/Gb mode*) or the G-RNTI (in *Iu mode*) shall be used to identify the mobile station.

If the network does not receive the PACKET CONTROL ACKNOWLEDGEMENT message or the PACKET RESOURCE REQUEST message in the radio block indicated by the RRBp field, it shall increment counter N3103 for the TBF and retransmit the PACKET UPLINK ACK/NACK message. If counter N3103 exceeds its limit, the network shall start timer T3169 for the TBF. When timer T3169 expires for the TBF the network may reuse the TFI and USF resources.

### 9.3.2.5 Operation of downlink Temporary Block Flow

The mobile station receives RLC/MAC blocks on the assigned downlink PDCHs. On each assigned PDCH, the mobile station shall in the RLC header identify the TFI and decode the RLC data blocks intended for the mobile station. The operation during the TBF shall be as defined in sub-clause 9.1.

### 9.3.2.6 Release of downlink Temporary Block Flow

If EMST is used (see sub-clause 5.10), the network shall release a downlink TBF by releasing all the RLC entities allocated on that TBF. The downlink TBF is successfully released when the last RLC entity is released. The network shall perform the release of an RLC entity operating in RLC acknowledged mode as specified in the present sub-clause. The network shall perform the release of an RLC entity operating in RLC unacknowledged mode as specified in sub-clause 9.3.3.5.

The network initiates the release of a downlink TBF, or if EMST is used, the release of an RLC entity on the downlink TBF by sending an RLC data block with the Final Block Indicator (FBI) set to the value '1' and with a valid RRBP field. The RLC data block sent must have the highest BSN' (see sub-clause 9.3.1) of the downlink TBF, or if EMST is used, of the RLC entity. The network shall start timer T3191 for the TBF, or if EMST is used, for the RLC entity. While timer T3191 is running for the TBF the network may retransmit the RLC data block with the FBI bit set to the value '1'. For each retransmission the timer T3191 is restarted.

In EGPRS TBF mode, if the final RLC data block is split for retransmission over two radio blocks (see sub-clause 9.3.2.1), the network shall set the FBI to the value '1' in each part of the retransmitted RLC data block.

If the mobile station receives an RLC data block (or, in EGPRS TBF mode, a part of a retransmitted RLC data block) with the FBI bit set the value '1' and with a valid RRBP field, the mobile station shall transmit a (EGPRS) PACKET DOWNLINK ACK/NACK or EGPRS PACKET DOWNLINK ACK/NACK TYPE 2 or EGPRS PACKET DOWNLINK ACK/NACK TYPE 3 or EGPRS PACKET DOWNLINK ACK/NACK DLMC message in the specified uplink block. The mobile station shall continue to monitor all assigned PDCHs.

Whenever the mobile station receives an RLC data block (or, in EGPRS TBF mode, a part of a retransmitted RLC data block) with a valid RRBP and the mobile station has received all RLC data blocks of the TBF, the mobile station shall send the (EGPRS) PACKET DOWNLINK ACK/NACK or EGPRS PACKET DOWNLINK ACK/NACK TYPE 2 or EGPRS PACKET DOWNLINK ACK/NACK TYPE 3 or EGPRS PACKET DOWNLINK ACK/NACK DLMC message with the Final Ack Indicator bit set to '1' in the reserved uplink radio block specified by the RRBP field, stop the timer T3190 for the TBF. If EMST is used, the mobile station shall stop the timer T3190 only if the (EGPRS) PACKET DOWNLINK ACK/NACK or EGPRS PACKET DOWNLINK ACK/NACK TYPE 2 or EGPRS PACKET DOWNLINK ACK/NACK TYPE 3 or EGPRS PACKET DOWNLINK ACK/NACK DLMC message with the Final Ack Indicator bit set to '1' corresponds to the last remaining RLC entity on the TBF. If the timeout value of timer T3192 (see sub-clause 12.24) is different from 0 ms then the mobile station shall start or restart timer T3192 for the TBF, or if EMST is used, for the RLC entity and continue to monitor all assigned downlink PDCHs. Otherwise, if the timeout value of timer T3192 is 0 ms then the mobile station shall follow the same procedure as if the timer T3192 has expired.

In GPRS TBF mode, if the mobile station receives more than one RLC data block with the FBI set to '1', it shall accept the data from only the first one of these blocks.

If the network receives a (EGPRS) PACKET DOWNLINK ACK/NACK or EGPRS PACKET DOWNLINK ACK/NACK TYPE 2 or EGPRS PACKET DOWNLINK ACK/NACK TYPE 3 or EGPRS PACKET DOWNLINK ACK/NACK DLMC message for the TBF, or if EMST is used, for the RLC entity before its timer T3191 expires, and if retransmissions are required, then the network stops timer T3191 for the TBF, or if EMST is used, for the RLC entity and retransmits necessary RLC data blocks according to the ARQ protocol before re-initiating the release of the downlink TBF, or if EMST is used, of the RLC entity. The FBI is set to '1' only if the RLC data block with the highest BSN' of the TBF, or if EMST is used, of the RLC entity is retransmitted. If no retransmission is required, the network shall stop timer T3191 for the TBF, or if EMST is used, for the RLC entity and start or restart timer T3193 for the TBF, or if EMST is used, of the RLC entity. When T3193 expires the network shall release the TBF, or if EMST is used, the associated RLC entity.

If timer T3191 expires for the TBF, then the network shall release the TBF, or if EMST is used, the associated RLC entity.

If the network has received the (EGPRS) PACKET DOWNLINK ACK/NACK or EGPRS PACKET DOWNLINK ACK/NACK TYPE 2 or EGPRS PACKET DOWNLINK ACK/NACK TYPE 3 or EGPRS PACKET DOWNLINK ACK/NACK DLMC message with the Final Ack Indicator bit set to '1' and has new data to transmit for the mobile station that cannot be transmitted on any ongoing downlink TBF, the network may establish one or more new downlink TBF(s) for the mobile station by sending on PACCH the PACKET DOWNLINK ASSIGNMENT, MULTIPLE TBF DOWNLINK ASSIGNMENT, PACKET TIMESLOT RECONFIGURE or MULTIPLE TBF TIMESLOT RECONFIGURE message with the Control Ack bit set to '1' for each TBF. The network may send these downlink assignment messages using the PACCH of any ongoing TBF for the mobile station. In case the network establishes a new downlink TBF for the mobile station, or if EMST is used, reconfigures the ongoing TBF using the PACCH of a

downlink TBF for which T3193 is running, the network shall stop that instance of timer T3193 and release that TBF, or if EMST is used, the associated RLC entity. The abnormal cases are described in sub-clause 8.1.2.4.1.

If the mobile station, after sending the PACKET DOWNLINK ACK/NACK message with the Final Ack Indicator bit set to '1' for a given TBF, receives a PACKET DOWNLINK ASSIGNMENT, MULTIPLE TBF DOWNLINK ASSIGNMENT, PACKET TIMESLOT RECONFIGURE or MULTIPLE TBF TIMESLOT RECONFIGURE message with the Control Ack bit set to '1' on the PACCH associated with this TBF while its timer T3192 is running, or if EMST is used, the timer T3192 associated with the RLC entity identified by the TFI included in the message is running, the mobile station shall stop this instance of timer T3192, consider this downlink TBF released, or if EMST is used, consider the associated RLC entity released and act upon the new assignments.

When timer T3192 expires the mobile station shall release the associated downlink TBF, or if EMST is used, the associated RLC entity. If there are no other ongoing TBFs, or if EMST is used, no other ongoing RLC entities, the mobile station in packet transfer mode or MAC-Shared state shall return to packet idle mode or MAC-Idle state; the mobile station in dual transfer mode respectively MAC-DTM state shall return to dedicated mode or MAC-Dedicated state. The DRX mode procedures shall be applied, as specified in sub-clause 5.5.1.5 and 3GPP TS 44.160. If there are one or more ongoing TBFs a mobile station shall remain in its current mode/state and can request additional uplink TBFs as follows:

- It may send a PACKET RESOURCE REQUEST message using the PACCH if there is at least one ongoing uplink TBF as described in sub-clause 8.1.1.1.2.
- It may include a Channel Request Description or the Extended Channel Request Description information element in the (EGPRS) PACKET DOWNLINK ACK/NACK or EGPRS PACKET DOWNLINK ACK/NACK TYPE 2 message if there are no ongoing uplink TBFs and at least one ongoing downlink TBF as described in sub-clause 8.1.2.5.

### 9.3.3 Unacknowledged mode operation

#### 9.3.3.0 General

The transfer of RLC data blocks in the RLC unacknowledged mode does not include any retransmissions, except during the release of a TBF where the last transmitted block may be retransmitted (see sub-clauses 9.3.3.3 and 9.3.3.5). In EGPRS TBF mode, retransmission with segmentation method shall not be used. The block sequence number (BSN) in the RLC data block header is used to number the RLC data blocks for reassembly.

The receiving RLC endpoint shall expect all RLC data blocks received in the same radio block period were sent in increasing order of BSN (apart from the last transmitted block of a TBF). As an exception, in a downlink dual carrier configuration or a DLMC configuration, the mobile station shall never expect RLC data blocks received in the same radio block period to have been sent in any specific order of BSN. In this case the mobile station shall re-order the received RLC data blocks before detecting any missing RLC data blocks.

The receiving side sends Packet Ack/Nack messages in order to convey the necessary other control signalling (e.g. monitoring of channel quality for downlink transfer or timing advance correction for uplink transfers).

#### 9.3.3.1 Establishment of Temporary Block Flow

If the last uplink TBF ended with an incompletely transmitted upper layer PDU, the mobile station shall begin transmission on the new TBF with the last incompletely transmitted upper layer PDU.

#### 9.3.3.2 Operation of uplink Temporary Block Flow

The network shall send PACKET UPLINK ACK/NACK messages when needed.

The mobile station shall set the Stall indicator (SI) bit to '0' in all RLC data blocks of the TBF.

If the mobile station transmits the number of RLC data blocks corresponding to the RLC window size (WS), without receiving a Packet Ack/Nack message the mobile station shall start timer T3182 for the TBF. Timer T3182 shall be stopped upon reception of a PACKET UPLINK ACK/NACK message for this TBF. If timer T3182 expires, the mobile station shall decrement counter N3102 by PAN\_DEC, and perform an abnormal release with access retry (see sub-clause 8.7.2 (*A/Gb mode*) or 3GPP TS 44.160 sub-clause 8.8.3 (*Iu mode*)).

Whenever the mobile station receives a PACKET UPLINK ACK/NACK message, the mobile station shall increment N3102 by PAN\_INC, however N3102 shall never exceed the value PAN\_MAX. Upon cell reselection the mobile station shall set counter N3102 to the value PAN\_MAX. When  $N3102 \leq 0$  is reached, the mobile station shall perform an abnormal release with cell re-selection (see sub-clause 9.4.2). If PAN\_DEC or PAN\_INC is set to the value 0, counter N3102 shall be disabled.

A mobile station operating with an exclusive allocation shall start or restart timer T3184 upon reception of a PACKET UPLINK ACK/NACK message. If timer T3184 expires, the mobile station shall perform an abnormal release with access retry (see sub-clause 9.4.1).

### 9.3.3.3 Release of uplink Temporary Block Flow

#### 9.3.3.3.1 General

In the non-extended uplink TBF mode, the mobile station initiates the release of the uplink TBF by beginning the countdown process (see sub-clause 9.3.1).

In the extended uplink TBF mode, the network determines when to release the uplink TBF. The release of an uplink TBF in the extended uplink TBF mode is performed by the procedure defined in sub-clause 9.5 (*A/Gb mode*) or 3GPP TS 44.160 (*Iu mode*).

#### 9.3.3.3.2 Non-extended uplink TBF mode

The mobile station indicates the end of the TBF by sending the RLC data block with CV = 0. The mobile station shall start timer T3182 for the TBF.

When the network detects the end of the TBF (i.e. when CV=0) it shall send a PACKET UPLINK ACK/NACK message with the Final Ack Indicator bit set to '1', include a valid RRBP field in the RLC/MAC control block header and clear counter N3103 for the TBF. The network may use the TBF Est field in the PACKET UPLINK ACK/NACK message to allow the mobile station to request the establishment of a new uplink TBF if there are no additional TBFs ongoing for that mobile station.

In case the network receives multiple blocks with CV=0, only the first needs to be acknowledged with PACKET UPLINK ACK/NACK message.

Upon reception of a PACKET UPLINK ACK/NACK message for this TBF the mobile station shall stop timer T3182 for the TBF.

If the PACKET UPLINK ACK/NACK message has the Final Ack Indicator bit set to "1" and the mobile station does not initiate the establishment of a new uplink TBF according to one of the procedures described below, the mobile station shall transmit the PACKET CONTROL ACKNOWLEDGEMENT message and release the TBF. If there are no other ongoing TBFs, the mobile station in packet transfer mode or MAC-Shared state shall enter packet idle mode or MAC-Idle state; the mobile station in dual transfer mode MAC-DTM state shall return to dedicated mode or MAC-Dedicated state. The DRX mode procedures shall be applied, as specified in sub-clause 5.5.1.5 and 3GPP TS 44.160. If there are one or more ongoing TBFs a mobile station shall remain in its current mode/state and can request additional uplink TBFs as follows:

- It may send a PACKET RESOURCE REQUEST message using the PACCH if there is at least one ongoing uplink TBF as described in sub-clause 8.1.1.1.2.
- It may include a Channel Request Description or the Extended Channel Request Description information element in the (EGPRS) PACKET DOWNLINK ACK/NACK or EGPRS PACKET DOWNLINK ACK/NACK TYPE 2 message or a Channel Request Description information element in the EGPRS PACKET DOWNLINK ACK/NACK DLMC message if there are no ongoing uplink TBFs and at least one ongoing downlink TBF as described in sub-clause 8.1.2.5.

If the PACKET UPLINK ACK/NACK message has the Final Ack Indicator bit set to '1' and the following conditions are fulfilled: TBF Est field is set to '1'; the mobile station has new data to transmit; the mobile station has no other ongoing TBFs, the mobile station shall release the uplink TBF and may request the establishment of a new TBF using one of the following procedures:

- If Control Ack Type parameter in System Information indicates acknowledgement is access burst, the mobile station shall transmit the PACKET CONTROL ACKNOWLEDGEMENT message with the Ctrl Ack bits set to

'00'. The mobile station shall start timer T3168 for the TBF request and continue to monitor the PDCH used for transmitting the PACKET CONTROL ACKNOWLEDGEMENT message. The mobile station shall stop timer T3168 for the TBF upon reception of the PACKET UPLINK ASSIGNMENT message including Single Block Allocation structure assigning resources for the TBF or the PACKET ACCESS REJECT message rejecting the TBF request. The mobile station shall use the same procedures as are used for TBF establishment using two phase access described in sub-clause 7.1.3 (*A/Gb mode*) or 3GPP TS 44.160 (*Iu mode*) starting from the point where the mobile station receives the PACKET UPLINK ASSIGNMENT message including Single Block Allocation structure or the PACKET ACCESS REJECT message.

- If Control Ack Type parameter in System Information indicates acknowledgement is RLC/MAC control block, the mobile station shall transmit the PACKET RESOURCE REQUEST message and start timer T3168 for the TBF request. The mobile station shall use the same procedures as are used for TBF establishment using two phase access described in sub-clause 7.1.3 (*A/Gb mode*) or 3GPP TS 44.160 (*Iu mode*) starting from the point where the mobile station transmits the PACKET RESOURCE REQUEST message.

If the PACKET UPLINK ACK/NACK message does not have the Final Ack Indicator bit set to '1', the mobile station shall repeat sending the last block with CV=0, until a PACKET UPLINK ACK/NACK message with Final Ack Indicator bit set to '1' is received for this TBF. Upon each retransmission of the last block with CV=0, the mobile station shall restart timer T3182 for the TBF. The block with CV=0 shall not be retransmitted more than four times. If the medium access mode is dynamic allocation, the repetitions are transmitted when the mobile station is scheduled USFs. If timer T3182 expires for the TBF the mobile station shall release the TBF as if a PACKET UPLINK ACK/NACK message was received.

When the network receives the PACKET CONTROL ACKNOWLEDGEMENT message or the PACKET RESOURCE REQUEST message in the radio block indicated by the RRBp field, it may reuse the TFI and USF resources.

If the network receives the PACKET CONTROL ACKNOWLEDGEMENT message with Ctrl Ack bits set to '00' or the PACKET RESOURCE REQUEST message in the radio block indicated by the RRBp field and the network has set the TBF Est field to '1' in the PACKET UPLINK ACK/NACK message, the network shall follow one of the following procedures:

- In case the mobile station requested the establishment of new TBF with the PACKET CONTROL ACKNOWLEDGEMENT message, the network shall respond to the mobile station with the PACKET UPLINK ASSIGNMENT message including Single Block Allocation structure or the PACKET ACCESS REJECT message on the same PDCH as the mobile station has sent the PACKET CONTROL ACKNOWLEDGEMENT message. TLLI (in *A/Gb mode*) or G-RNTI (in *Iu mode*) shall be used to identify the mobile station. The network shall use the same procedures as are used for TBF establishment using two phase access described in sub-clause 7.1.3 (*A/Gb mode*) or 3GPP TS 44.160 (*Iu mode*) starting from the point where the network transmits the PACKET UPLINK ASSIGNMENT message including Single Block Allocation structure or the PACKET ACCESS REJECT message.
- In case the mobile station requested the establishment of new TBF with the PACKET RESOURCE REQUEST message, the network shall use the same procedures as are used for TBF establishment using two phase access described in sub-clause 7.1.3 (*A/Gb mode*) or 3GPP TS 44.160 (*Iu mode*) starting from the point where the network has received the PACKET RESOURCE REQUEST message. TLLI (in *A/Gb mode*) or G-RNTI (in *Iu mode*) shall be used to identify the mobile station.

If the network does not receive the PACKET CONTROL ACKNOWLEDGEMENT message or the PACKET RESOURCE REQUEST message for the TBF in the radio block indicated by the RRBp field, it shall increment counter N3103 and retransmit the PACKET UPLINK ACK/NACK message for the TBF. If counter N3103 exceeds its limit, the network shall start timer T3169 for the TBF. When timer T3169 expires for the TBF the network may reuse the TFI and USF resources.

#### 9.3.3.4 Operation of downlink Temporary Block Flow

The mobile station receives RLC/MAC blocks on the assigned downlink PDCHs. On each assigned PDCH, the mobile station shall in the RLC header identify the TFI and decode the RLC data blocks intended for the mobile station. The operation during the TBF shall be as defined in sub-clause 9.1 (*A/Gb mode*) or 3GPP TS 44.160 (*Iu mode*).

#### 9.3.3.5 Release of downlink Temporary Block Flow

If EMST is used (see sub-clause 5.10), the network shall release a downlink TBF by releasing all the RLC entities allocated on that TBF. The downlink TBF is successfully released when the last RLC entity is released. The network



shall perform the release of an RLC entity operating in RLC unacknowledged mode as specified in the present sub-clause. The network shall perform the release of an RLC entity operating in RLC acknowledged mode as specified in sub-clause 9.3.2.6.

The network initiates the release of a downlink TBF, or if EMST is used, the release of an RLC entity on a downlink TBF by sending an RLC data block with the Final Block Indicator (FBI) set to the value '1' and with a valid RRBP field. The RLC data block sent must have the highest BSN' (see sub-clause 9.3.1) of the downlink TBF, or if EMST is used, of the RLC entity. The network shall start timer T3191 for the TBF, or if EMST is used, for the RLC entity. The network may retransmit the last block with FBI set to the value '1' and with a valid RRBP field. For each retransmission for the TBF, or if EMST is used, for each retransmission for the RLC entity, the timer T3191 is restarted.

For each RLC data block with the FBI bit set to '1' and with a valid RRBP field, the mobile station shall transmit the PACKET CONTROL ACKNOWLEDGEMENT message in the uplink block specified by the RRBP field. The mobile station shall continue to read the assigned downlink PDCHs until the block period pointed to by the RRBP. If the mobile station receives more than one RLC data block with the FBI bit set to '1' and with valid RRBP fields that point the same uplink block period, the mobile station shall transmit the PACKET CONTROL ACKNOWLEDGEMENT message only once. The mobile station shall then stop timer T3190 for the TBF. If EMST is used, the mobile station shall stop the timer T3190 only if the (EGPRS) PACKET DOWNLINK ACK/NACK or EGPRS PACKET DOWNLINK ACK/NACK TYPE 2 or EGPRS PACKET DOWNLINK ACK/NACK TYPE 3 or EGPRS PACKET DOWNLINK ACK/NACK DLMC message with the Final Ack Indicator bit set to '1' corresponds to the last remaining RLC entity on the TBF. If the timeout value of timer T3192 (see sub-clause 12.24) is different from 0 ms then the mobile station shall start timer T3192 for the TBF, or if EMST is used, for the RLC entity and continue to monitor all assigned downlink PDCHs. Otherwise, if the timeout value of timer T3192 is 0 ms then the mobile station shall follow the procedure as if the timer T3192 has expired.

If the mobile station then receives a subsequent RLC data block with a valid RRBP and the FBI bit set to '1', the mobile station shall retransmit the PACKET CONTROL ACKNOWLEDGEMENT message and restart timer T3192 for the TBF, or if EMST is used, for the associated RLC entity.

In GPRS TBF mode, if the mobile station receives more than one RLC data block with the FBI set to '1' for the same RLC instance, it shall accept the data from only the first one of these blocks.

If the network receives the PACKET CONTROL ACKNOWLEDGEMENT message for the TBF, or if EMST is used, for the RLC entity before timer T3191 expires, the network shall stop timer T3191 for the TBF, or if EMST is used, for the associated RLC entity and start or restart timer T3193 for the TBF, or if EMST is used, for the RLC entity. When T3193 expires the network shall release the TBF, or if EMST is used, the associated RLC entity.

If timer T3191 expires, the network shall release the associated TBF, or if EMST is used, the associated RLC entity.

If the network has received the PACKET CONTROL ACKNOWLEDGEMENT message and has new data to transmit for the mobile station, the network may establish one or more new downlink TBF(s) for the mobile station by sending on PACCH the PACKET DOWNLINK ASSIGNMENT, MULTIPLE TBF DOWNLINK ASSIGNMENT, PACKET TIMESLOT RECONFIGURE or MULTIPLE TBF TIMESLOT RECONFIGURE message with the Control Ack bit set to '1' for each TBF. In case the network establishes a new downlink TBF for a mobile station that does not support multiple TBF procedures, or if EMST is used, reconfigures the ongoing TBF, the network shall stop timer T3193 for the TBF, or if EMST is used, for the associated RLC entity.

If the mobile station, after sending the (EGPRS) PACKET DOWNLINK ACK/NACK or EGPRS PACKET DOWNLINK ACK/NACK TYPE 2 or EGPRS PACKET DOWNLINK ACK/NACK TYPE 3 or EGPRS PACKET DOWNLINK ACK/NACK DLMC message with the Final Ack Indicator bit set to '1' for a given TBF, receives a PACKET DOWNLINK ASSIGNMENT, MULTIPLE TBF DOWNLINK ASSIGNMENT, PACKET TIMESLOT RECONFIGURE or MULTIPLE TBF TIMESLOT RECONFIGURE message with the Control Ack bit set to '1' on the PACCH associated with this TBF while its timer T3192 is running, or if EMST is used, while the timer T3192 associated with the RLC entity identified by the TFI included in the message is running, the mobile station shall stop this instance of timer T3192, consider this downlink TBF, or if EMST is used, the associated RLC entity released and act upon the new assignments.

When timer T3192 expires then the mobile station shall release the related downlink TBF, or if EMST is used, the associated RLC entity. If there are no other ongoing TBF the mobile station in packet transfer mode or MAC-Shared state shall enter packet idle mode or MAC-Idle state; the mobile station in dual transfer mode or MAC-DTM state shall return to dedicated mode or MAC-Dedicated state. The DRX mode procedures shall be applied as specified in sub-clause 5.5.1.5, 3GPP TS 44.160. If there are one or more ongoing TBFs a mobile station shall remain in its current mode/state and can request additional uplink TBFs as follows:

- It may send a PACKET RESOURCE REQUEST message using the PACCH if there is at least one ongoing uplink TBF as described in sub-clause 8.1.1.1.2.
- It may include a Channel Request Description or the Extended Channel Request Description information element in the (EGPRS) PACKET DOWNLINK ACK/NACK or EGPRS PACKET DOWNLINK ACK/NACK TYPE 2 message if there are no ongoing uplink TBFs and at least one ongoing downlink TBF as described in sub-clause 8.1.2.5.

## 9.3.4 Non-persistent mode operation

### 9.3.4.0 General

The transfer of RLC data blocks in RLC non-persistent mode includes non-exhaustive retransmissions. The block sequence number (BSN) in the RLC data block header is used to number the RLC data blocks for reassembly. When RLC non-persistent mode is used for an MBMS bearer the receiving side sends MBMS DOWNLINK ACK/NACK messages to inform the transmitting side of the status of the reception and to convey neighbouring cell measurements. When RLC non-persistent mode is used for an EGPRS TBF the receiving side sends a PACKET UPLINK ACK/NACK, an EGPRS PACKET DOWNLINK ACK/NACK, an EGPRS PACKET DOWNLINK ACK/NACK TYPE 2, an EGPRS PACKET DOWNLINK ACK/NACK TYPE 3 or EGPRS PACKET DOWNLINK ACK/NACK DLMC message to inform the transmitting side of the reception status.

#### 9.3.4.1 Operation during an MBMS bearer

The mobile station receives RLC/MAC blocks on the assigned downlink PDCHs. On each assigned PDCH, the mobile station shall in the RLC/MAC header identify the MBMS\_BEARER\_ID within the TFI field and decode the RLC data blocks if the mobile station is monitoring that MBMS Bearer. The operation during the MBMS bearer shall be as defined in sub-clause 9.1

#### 9.3.4.2 Release of an MBMS radio bearer

The network may initiate the normal or abnormal release of an MBMS radio bearer by transmitting a PACKET TBF RELEASE message to the mobile station(s) on the PACCH, as described in sub-clause 8.1.4.4.

The Final Block Indicator (FBI) bit shall not be set to the value '1' in any RLC/MAC block for data transfer of the MBMS radio bearer.

#### 9.3.4.3 Operation during an EGPRS TBF

The MAC procedures defined in sub-clause 8.1.1 and 8.1.2 apply for EGPRS TBFs that make use of RLC non-persistent mode. Release of an uplink EGPRS TBF operating in Non-persistent mode is specified in sub-clause 9.5. Release of a downlink EGPRS TBF operating in Non-persistent mode is as specified for RLC unacknowledged mode, (see sub-clause 9.3.3.5).

## 9.4 Abnormal release cases

### 9.4.1 Abnormal release with access retry

The procedure for abnormal release with access retry is defined in sub-clause 8.7.2.

### 9.4.2 Abnormal release with cell reselection

If the mobile station is not in dedicated mode of a circuit switched connection, or is in MAC-Shared state, the mobile station shall abort all TBFs in progress and return to packet idle mode or MAC-Idle state. The mobile station shall perform an abnormal cell reselection (see 3GPP TS 45.008) and initiate the establishment of one or more uplink TBFs, using the procedures on CCCH or PCCCH as defined in sub-clause 7.1 on the new cell. The mobile station shall not reselect back to the original cell for T\_RESEL seconds if another suitable cell is available.

If the abnormal cell reselection is abandoned (see 3GPP TS 45.008), the mobile station shall report an RLC/MAC failure to upper layers. If the mobile station remains in the cell where the abnormal release occurred, the DRX mode procedures shall be applied, as specified in sub-clause 5.5.1.5, 3GPP TS 44.160 sub-clause 5.4.1.8.

If the mobile station is in dedicated mode of a circuit switched connection (applies in GPRS class A mode of operation) or is in MAC-DTM state, the mobile station shall perform an abnormal release without retry, defined in sub-clause 8.7.1.

The parameter T\_RESEL (default value 5 s) is broadcast in PSI 3.

## 9.5 Uplink TBF release in extended uplink TBF mode

In the extended uplink TBF mode (see sub-clause 9.3.1b), the network may initiate the release an uplink TBF by sending a PACKET UPLINK ACK/NACK message with the Final Ack Indicator set to '1'. The network shall include a valid RRBP field in the RLC/MAC control block header and clear counter N3103 for the TBF. The network may use the TBF Est field in the PACKET UPLINK ACK/NACK message to allow the mobile station to request the establishment of new TBF. The release of the uplink TBF, using this procedure, may be initiated at a point determined by the network.

In case EMST is used, the network shall release an uplink TBF by releasing all the RLC entities allocated on that uplink TBF. The uplink TBF is successfully released when the last RLC entity is released. The network shall perform the release of an RLC entity as specified in this sub-clause.

If the PACKET UPLINK ACK/NACK message has the Final Ack Indicator bit set to '1' and the following conditions are fulfilled: TBF Est field is set to '1'; the mobile station has new data to transmit; the mobile station has no other ongoing TBFs, or if EMST is used, no other active RLC entity, the mobile station shall release the uplink TBF and may request the establishment of a new TBF using one of the following procedures:

- If Control Ack Type parameter in System Information indicates acknowledgement is access burst, the mobile station shall transmit the PACKET CONTROL ACKNOWLEDGEMENT message with the Ctrl Ack bits set to '00'. The mobile station shall start timer T3168 for the TBF request and continue to monitor the PDCH used for transmitting the PACKET CONTROL ACKNOWLEDGEMENT message. The mobile station shall stop timer T3168 for the TBF upon reception of the PACKET UPLINK ASSIGNMENT message including Single Block Allocation structure assigning resources for the TBF or the PACKET ACCESS REJECT message rejecting the TBF request. The mobile station shall use the same procedures as are used for TBF establishment using two phase access described in sub-clause 7.1.3 starting from the point where the mobile station receives the PACKET UPLINK ASSIGNMENT message including Single Block Allocation structure or the PACKET ACCESS REJECT message.
- If Control Ack Type parameter in System Information indicates acknowledgement is RLC/MAC control block, the mobile station shall transmit the PACKET RESOURCE REQUEST message and start timer T3168 for the TBF request. The mobile station shall use the same procedures as are used for TBF establishment using two phase access described in sub-clause 7.1.3 starting from the point where the mobile station transmits the PACKET RESOURCE REQUEST message.

If the PACKET UPLINK ACK/NACK message has the Final Ack Indicator bit set to '1' and the mobile station does not initiate the establishment of a new uplink TBF according to one of the procedures described above, the mobile station shall transmit the PACKET CONTROL ACKNOWLEDGEMENT message and release the TBF, or if EMST is used, the RLC entity. If there are no other ongoing TBFs, or if EMST is used, no other ongoing RLC entities, the mobile station in packet transfer mode shall return to packet idle mode; the mobile station in dual transfer mode shall return to dedicated mode. The DRX mode procedures shall be applied as specified in sub-clause 5.5.1.5. If there are one or more ongoing TBFs a mobile station shall remain in its current mode/state and can request additional uplink TBFs as follows:

- It may send a PACKET RESOURCE REQUEST message using the PACCH if there is at least one ongoing uplink TBF as described in sub-clause 8.1.1.1.2.
- It may include a Channel Request Description or the Extended Channel Request Description information element in the (EGPRS) PACKET DOWNLINK ACK/NACK message or EGPRS PACKET DOWNLINK ACK/NACK TYPE 2 message or a Channel Request Description information element in the EGPRS PACKET DOWNLINK ACK/NACK DLMC message if there are no ongoing uplink TBFs and at least one ongoing downlink TBF as described in sub-clause 8.1.2.5.

When the network receives the PACKET CONTROL ACKNOWLEDGEMENT message or the PACKET RESOURCE REQUEST message in the radio block indicated by the RRBP field, it may reuse the TFI and USF resources. If EMST is used, the USF resources may be reused only if the TBF is released, i.e. the last RLC entity allocated on the uplink TBF is released.

When EMST is not used or when EMST is used and the last RLC entity is released, if the network receives the PACKET CONTROL ACKNOWLEDGEMENT message with Ctrl Ack bits set to '00' or the PACKET RESOURCE REQUEST message in the radio block indicated by the RRBP field and the network has set the TBF Est field to '1' in the PACKET UPLINK ACK/NACK message, the network shall follow one of the following procedures:

- In case the mobile station requested the establishment of new TBF with the PACKET CONTROL ACKNOWLEDGEMENT message, the network shall respond to the mobile station with the PACKET UPLINK ASSIGNMENT message including Single Block Allocation structure or the PACKET ACCESS REJECT message on the same PDCH as the mobile station has sent the PACKET CONTROL ACKNOWLEDGEMENT message. TLLI shall be used to identify the mobile station. The network shall use the same procedures as are used for TBF establishment using two phase access described in sub-clause 7.1.3 starting from the point where the network transmits the PACKET UPLINK ASSIGNMENT message including Single Block Allocation structure or the PACKET ACCESS REJECT message.
- In case the mobile station requested the establishment of new TBF with the PACKET RESOURCE REQUEST message, the network shall use the same procedures as are used for TBF establishment using two phase access described in sub-clause 7.1.3 starting from the point where the network has received the PACKET RESOURCE REQUEST message. TLLI shall be used to identify the mobile station.

If the network does not receive the PACKET CONTROL ACKNOWLEDGEMENT message or the PACKET RESOURCE REQUEST message for the TBF, or if EMST is used, for the RLC entity in the radio block indicated by the RRBP field, it shall increment counter N3103 and retransmit the PACKET UPLINK ACK/NACK message for the TBF, or if EMST is used, the RLC entity. When EMST is not used or when EMST is used and the last RLC entity is released, if counter N3103 exceeds its limit, the network shall stop scheduling new uplink resources for the TBF, stop sending the PACKET UPLINK ACK/NACK message to the mobile station and start timer T3169 for the TBF.

When timer T3169 expires for the TBF, the network may reuse the TFI and USF resources. If EMST is used for the TBF, the USF resources may be reused only once the TBF is released, i.e. the last RLC entity allocated on the uplink TBF is released.

---

## 10 RLC/MAC block structure

### 10.0a RLC/MAC block structure

Different RLC/MAC block structures are defined for data transfers and for control message transfers. The RLC/MAC block structures for data transfers are different for GPRS and EGPRS, whereas the same RLC/MAC block structure is used for control message transfers.

#### 10.0a.1 GPRS RLC/MAC block for data transfer

The RLC/MAC block for GPRS data transfer consists of a MAC header and an RLC data block. The RLC data block consists of an RLC header, an RLC data unit and spare bits.

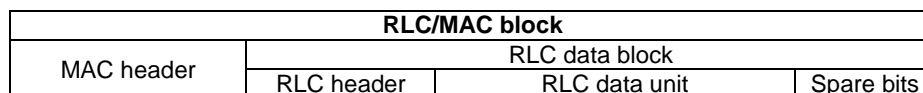

**Figure 10.0a.1.1: RLC/MAC block structure for data transfer for GPRS**

The RLC data unit contains octets from one or more upper layer PDUs.

#### 10.0a.2 EGPRS RLC/MAC block for data transfer

The RLC/MAC block for EGPRS and EGPRS2 data transfer is shown in figure 10.0a.2.1 and consists of:

- a combined RLC/MAC header,
- one or two RLC data blocks for EGPRS, or up to four RLC data blocks for EGPRS2,
- an optional PAN field which is included in case FANR is activated,
- and an optional eTFI field which is included for the case where a mobile station in a DL-MC configuration is assigned an eTFI for a downlink TBF. If an eTFI is assigned for a downlink TBF then an eTFI is included in an uplink RLC/MAC block for data transfer only if a PAN field corresponding to that downlink TBF is also included.

RLC/MAC block						
RLC/MAC header	RLC data block 1	RLC data block 2 (conditional)	RLC data block 3 (conditional)	RLC data block 4 (conditional)	PAN (optional)	eTFI (optional)

**Figure 10.0a.2.1: RLC/MAC block structure for EGPRS and EGPRS2 data transfer**

Each RLC data blocks contain octets from one or more upper layer PDUs.

The PAN field may only be included within an EGPRS RLC/MAC block for data transfer within a TBF with FANR activated.

In EGPRS, depending on the modulation and coding scheme (see 3GPP TS 44.004 and 3GPP TS 45.003) one or two RLC data blocks are contained in one RLC/MAC block. For MCS-1, MCS-2, MCS-3, MCS-4, MCS-5 and MCS-6 there is one RLC data block, whereas for MCS-7, MCS-8 and MCS-9 there are two RLC data blocks in the RLC/MAC block.

In EGPRS, in each transfer direction, uplink and downlink, three different header types are defined. Which header type that is used depends on the modulation and coding scheme (MCS):

- Header type 1 is used with modulation and coding scheme MCS-7, MCS-8 and MCS-9.
- Header type 2 is used with modulation and coding scheme MCS-5 and MCS-6.
- Header type 3 is used with modulation and coding scheme MCS-1, MCS-2, MCS-3 and MCS-4.

In EGPRS2, depending on the modulation and coding scheme (see 3GPP TS 44.004 and 3GPP TS 45.003) one to four RLC data blocks are contained in one RLC/MAC block as follows:

- One RLC data block per RLC/MAC block: MCS-1, MCS-2, MCS-3, MCS-4, MCS-5, MCS-6, DAS-5, DAS-6, DAS-7, DBS-5, DBS-6, UBS-5 and UBS-6;
- Two RLC data blocks per RLC/MAC block: MCS-7, MCS-8, MCS-9, DAS-8, DAS-9, DAS-10, DBS-7, DBS-8, UAS-7, UAS-8, UAS-9, UBS-7 and UBS-8;
- Three RLC data blocks per RLC/MAC block: DAS-11, DAS-12, DBS-9, DBS-10, UAS-10, UAS-11, UBS-9 and UBS-10;
- Four RLC data blocks per RLC/MAC block: DBS-11, DBS-12, UBS-11 and UBS-12.

In EGPRS2, ten header types are used in the downlink direction. Which header type is used depends on the modulation and coding scheme:

- Header type 1 is used with modulation and coding scheme MCS-7, MCS-8 and MCS-9
- Header type 2 is used with modulation and coding scheme DAS-5, DAS-6 and DAS-7.
- Header type 3 is used with modulation and coding scheme MCS-1, MCS-2, MCS-3 and MCS-4.
- Header type 4 is used with modulation and coding scheme DAS-8 and DAS-9.
- Header type 5 is used with modulation and coding scheme DAS-11 and DAS-12.
- Header type 6 is used with modulation and coding scheme DBS-5 and DBS-6.
- Header type 7 is used with modulation and coding scheme DBS-7 and DBS-8.

Header type 8 is used with modulation and coding scheme DBS-9 and DBS-10.

Header type 9 is used with modulation and coding scheme DBS-11 and DBS-12.

Header type 10 is used with modulation and coding scheme DAS-10.

In EGPRS2, eight header types are used in the uplink direction. Which header type is used depends on the modulation and coding scheme:

Header type 2 is used with modulation and coding scheme MCS-5 and MCS-6.

Header type 3 is used with modulation and coding scheme MCS-1, MCS-2, MCS-3 and MCS-4.

Header type 4 is used with modulation and coding scheme UAS-7, UAS-8 and UAS-9.

Header type 5 is used with modulation and coding scheme UAS-10 and UAS-11.

Header type 6 is used with modulation and coding scheme UBS-5 and UBS-6.

Header type 7 is used with modulation and coding scheme UBS-7 and UBS-8.

Header type 8 is used with modulation and coding scheme UBS-9 and UBS-10.

Header type 9 is used with modulation and coding scheme UBS-11 and UBS-12.

### 10.0a.3 RLC/MAC block for control message transfer

The downlink RLC/MAC block for control message transfer not associated with a TBF assigned an eTFI and an uplink RLC/MAC block for control message transfer consists of a MAC header and an RLC/MAC control block as shown in Figure 10.0a.3.1.



**Figure 10.0a.3.1: RLC/MAC block structure for control block**

The downlink RLC/MAC block for control message transfer associated with a TBF assigned an eTFI consists of a MAC header, an RLC/MAC control block and an eTFI field as shown in Figure 10.0a.3.2.

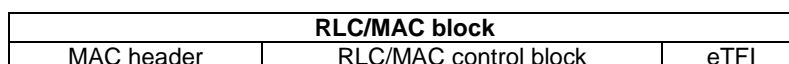

**Figure 10.0a.3.2: RLC/MAC block structure for control block (DLMC configuration used)**

## 10.0b RLC/MAC block format conventions

### 10.0b.1 Numbering convention

The physical layer transfers RLC/MAC blocks, 11-bit and 8-bit control messages in physical blocks of the packet data channel. The physical block formats are specified in 3GPP TS 44.004. The physical block is organised as a sequence of  $N1$  octets that are numbered from 1 to  $N1$ . An octet is a sequence of eight bits that are numbered from 1 to 8. If the total number of bits in a physical block is not an integer number of octets, the last bits of the physical block (in octet number  $N1$ ) does not form a complete octet. The bits that are transferred in the last, and possibly incomplete octet, are numbered from 1 to  $n$ , where  $1 \leq n \leq 8$ . The total number of bits in the physical block is  $8(N1 - 1) + n$ .

### 10.0b.2 Assembling conventions

Different assembling conventions apply for GPRS RLC data blocks, RLC/MAC control blocks, 11-bit and 8-bit control messages and EGPRS RLC data blocks.

### 10.0b.2.1 Assembling convention for GPRS RLC data blocks and RLC/MAC control blocks, 11-bit and 8-bit control messages

The different components of an RLC/MAC block carrying a GPRS RLC data block or an RLC/MAC control block shall be assembled sequentially. Each component consists of an integer number of octets. The assembling of components shall be performed progressively, starting in octet number 1 of the physical block.

The 11-bit and 8-bit control messages map directly into the corresponding physical block.

In this respect, an RLC/MAC control message, defined in sub-clause 11, or a segment of an RLC/MAC control message, see sub-clause 9.1.12a, shall be treated as a single field of either:

- 176 bits (22 octets, using the PBCCH/PCCCH downlink/CS-1 encoded PACCH block format),
- 304 bits (38 octets, using the CS-3 encoded PACCH block format),
- 11 bits or 8 bits (using the PRACH uplink/PACCH uplink short acknowledgement block formats, see 3GPP TS 44.004).

The message contents defines a sequence of bits in decreasing order of value, i.e. the first bit of the message contents represents the highest order value and the last bit the lowest order value.

The RLC/MAC header and a GPRS RLC data block are components that consist of an integer number of octets. Each octet shall be treated as a separate field when mapped into the physical block. The lowest numbered bit represents the lowest order value.

The PDTCH block type 2 (CS-2), type 3 (CS-3) and type 4 (CS-4) formats (see 3GPP TS 44.004) do not have an integer number of octets. In these block types, bits number n to 1 of octet number N1 are spare bits.

### 10.0b.2.2 Assembling convention for EGPRS RLC data blocks

The different components of the RLC/MAC block carrying an EGPRS RLC data block shall be assembled sequentially. A component may consist of a non-integer number of octets. Each octet shall be treated as a separate field when mapped into the physical block. The lowest numbered bit represents the lowest order value.

The assembling of components shall be performed progressively, starting with octet number 1 of the physical block. If the boundary between two components falls within an octet of the physical block, the components, or parts thereof, that are contained in that octet shall be assembled progressively, starting with bit number 1 of the octet. (i.e. going from bit number 1 to bit number 8, except in octet number N1, where components are assembled going from bit number 1 to bit number n).

## 10.0b.3 Field mapping conventions

Different field mapping conventions apply for GPRS RLC data blocks, RLC/MAC control blocks, 11-bit and 8-bit control messages and EGPRS RLC data blocks.

### 10.0b.3.1 Field mapping convention for GPRS RLC data blocks, CS-1 or CS-3 encoded RLC/MAC control blocks, 11-bit and 8-bit control messages

When a field within a GPRS RLC data block or a CS-1 encoded RLC/MAC control block, or a CS-3 encoded RLC/MAC control block, or an 11-bit or an 8-bit control message is contained within a single octet of the physical block, the lowest numbered bit of the field represents the lowest order value.

When a field spans more than one octet of the physical block, the order of bit values within each octet progressively *decreases* as the octet number increases. In that part of a field contained in a given octet, the lowest numbered bit represents the lowest order value.

### 10.0b.3.2 Field mapping convention for EGPRS RLC data blocks and MCS-0 encoded RLC/MAC control blocks

When a field within an EGPRS RLC data block is contained within a single octet of the physical block, the lowest numbered bit of the field represents the lowest order value.

When a field spans more than one octet of the physical block, the order of bit values within each octet progressively *increases* as the octet number increases. In that part of a field contained in a given octet, the lowest numbered bit represents the lowest order value.

## 10.1 Spare bits

Where the description of RLC/MAC blocks in this Technical Specification contains bits defined to be 'spare bits', these bits shall set to the value '0' by the sending side, and their value shall be ignored by the receiving side.

## 10.2 GPRS RLC data blocks

The RLC data block consists of an RLC header, an RLC data unit, and spare bits. An RLC/MAC block containing an RLC data block may be encoded using any of the available channel coding schemes CS-1, CS-2, CS-3, or CS-4 (see 3GPP TS 45.003). RLC/MAC blocks encoded using CS-1 do not contain spare bits. The size of the RLC data block for each of the channel coding schemes is shown in table 10.2.1.

**Table 10.2.1: RLC data block size**

Channel Coding Scheme	RLC data block size without spare bits (N2) (octets)	Number of spare bits	RLC data block size (octets)
CS-1	22	0	22
CS-2	32	7	32 7/8
CS-3	38	3	38 3/8
CS-4	52	7	52 7/8

### 10.2.1 Downlink RLC data block

The Downlink RLC data block together with its MAC header is formatted as shown in figure 10.2.1.1.

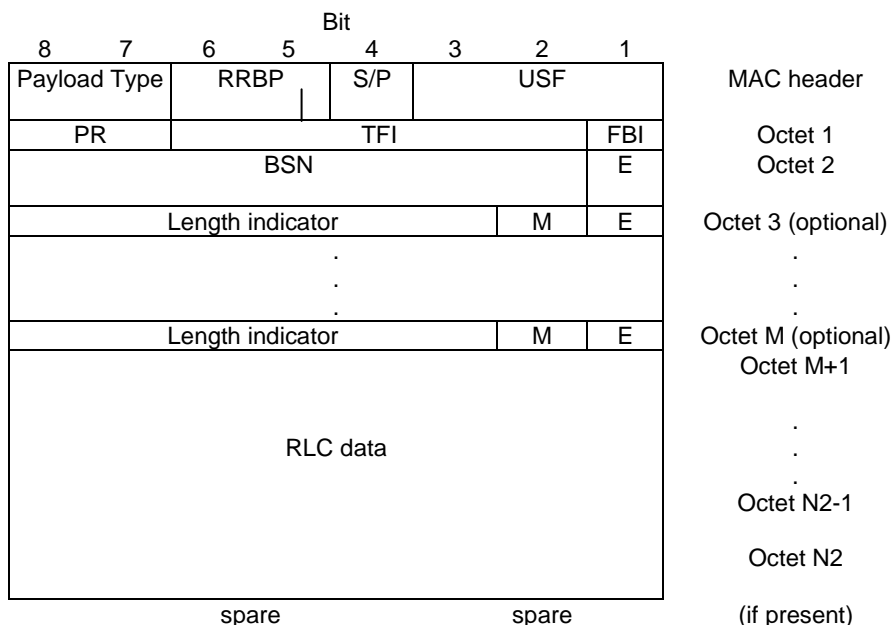
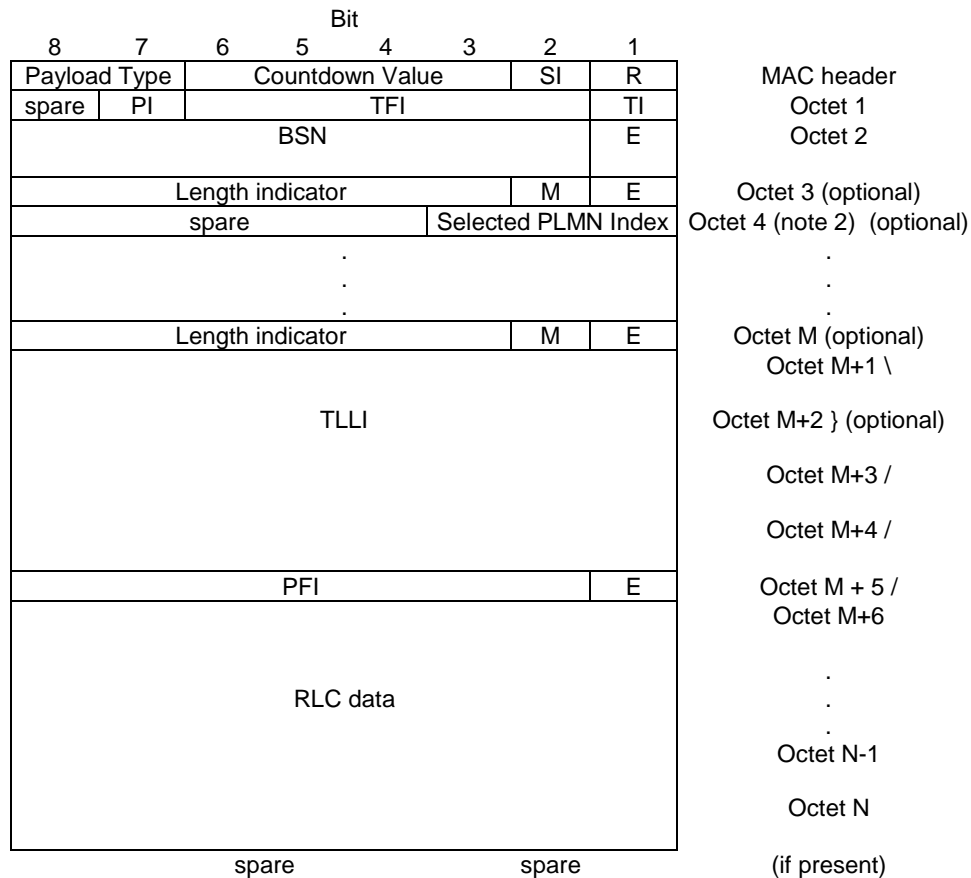

**Figure 10.2.1.1: Downlink RLC data block with MAC header**



### 10.2.2 Uplink RLC data block

The Uplink RLC data block together with its MAC header is formatted as shown in figure 10.2.2.1.



NOTE 1: The field mapping convention for GPRS (sub-clause 10.0b.3.1) applies. According to that, in particular regarding the TLLI field, the *most significant byte* of the TLLI value shall be mapped on octet M+1 and the *least significant byte* of the TLLI value shall be mapped on octet M+4 of the uplink RLC data block.

NOTE 2: This octet is only included if the value of the first instance of the Length indicator in the RLC data block is 62.

**Figure 10.2.2.1: Uplink RLC data block with MAC header**

### 10.3 RLC/MAC control blocks

The RLC/MAC control block consists of a control message contents field and in the downlink direction an optional control header. RLC/MAC control messages shall be transported within RLC/MAC control blocks. An RLC/MAC control blocks shall always be encoded using the coding scheme CS-1 (see 3GPP TS 44.004), except in the following conditions:

- on a downlink PDCH-pair assigned to a TBF in RTTI configuration with BTTI USF mode, downlink RLC/MAC control blocks shall always be encoded using coding scheme MCS-0;
- on a downlink PDCH-pair assigned to a TBF in RTTI configuration with RTTI USF mode, downlink RLC/MAC control blocks shall always be encoded using either coding scheme CS-1 or coding scheme MCS-0; an MS can differentiate CS-1 blocks from MCS-0 blocks by examining the stealing bits.
- a mobile station that supports more than 20 timeslots in a DLMC configuration (see sub-clause 5.13) may send an EGPRS Packet Downlink Ack/Nack DLMC message using the coding scheme CS-1 or CS-3 as indicated by the *PDAN Coding* IE in the most recently received assignment message. However, a mobile station that has been commanded to use CS-3 shall use CS-1 for any given EGPRS Packet Downlink Ack/Nack DLMC message that includes a request for an uplink TBF.

### 10.3.1 Downlink RLC/MAC control block

#### 10.3.1.1 Blocks encoded using CS-1

The Downlink RLC/MAC control block together with its MAC header is formatted as shown in figure 10.3.1.1.

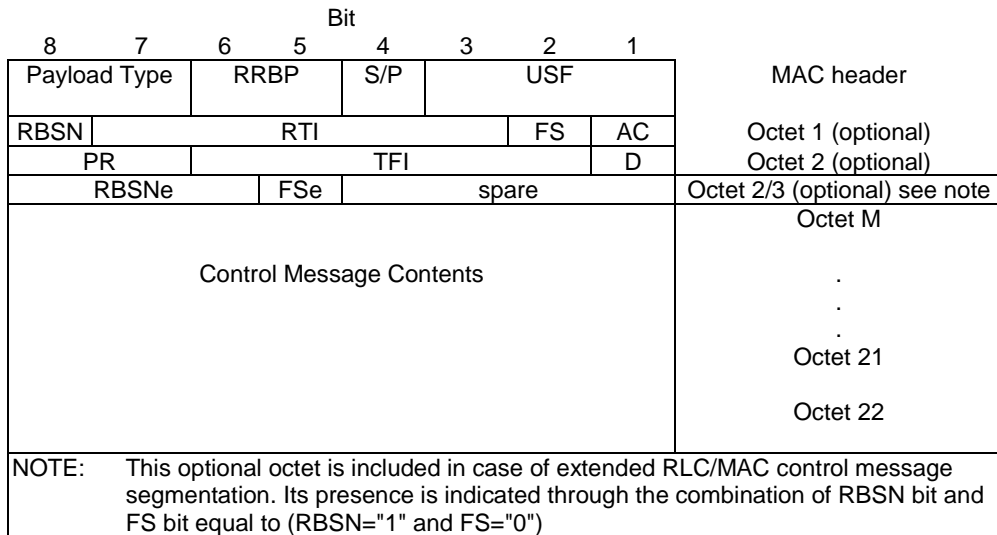
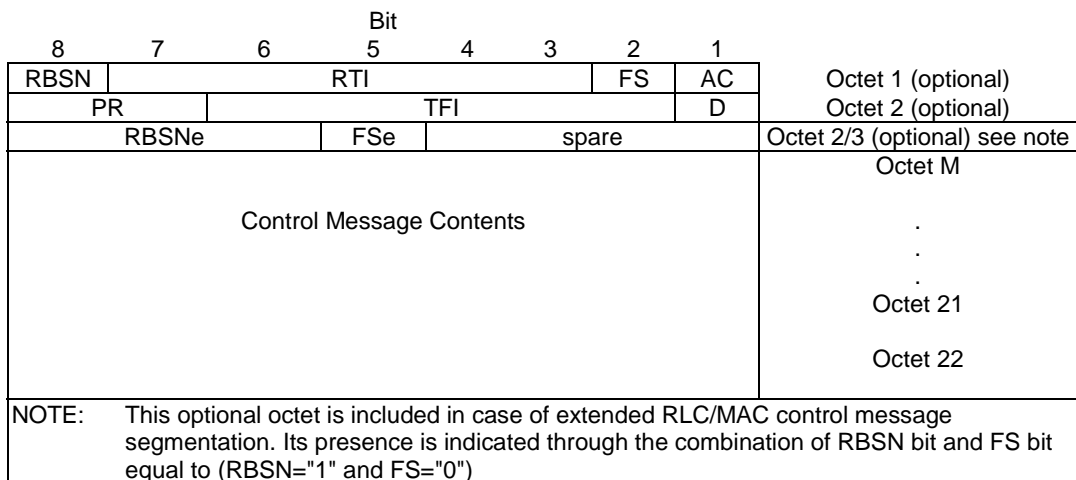

**Figure 10.3.1.1: Downlink RLC/MAC control block together with its MAC header**

NOTE: The header octets and the control message contents octets shall be encoded following the field mapping convention defined in sub-clause 10.0b.3.1.

#### 10.3.1.2 Blocks encoded using MCS-0

The downlink RLC/MAC control block header shall use the Header type 3 as shown in figure 10.3a.3.3.3 of subclause 10.3a.3.3. The RLC/MAC control block message contents are formatted as shown in figure 10.3.1.2.

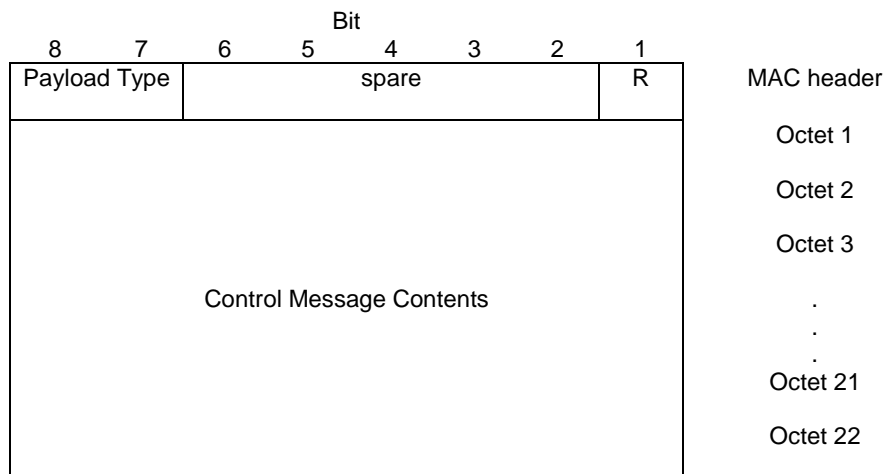

**Figure 10.3.1.2: Downlink RLC/MAC control block message contents**

NOTE: The optional header octets and the control message contents octets shall be encoded following the field mapping convention defined in sub-clause 10.0b.3.2.

### 10.3.2 Uplink RLC/MAC control block

The Uplink RLC/MAC control block together with its MAC header is formatted as shown in figure 10.3.2.1.



**Figure 10.3.2.1: Uplink RLC/MAC control block together with its MAC header**

### 10.3a EGPRS RLC data blocks and RLC/MAC headers

#### 10.3a.0 General

The EGPRS RLC data block consists of a FBI (downlink) or TI (uplink) field and an E field followed by an EGPRS RLC data unit. The EGPRS RLC data unit is a sequence of N2 octets that are numbered from 1 to N2.

**NOTE:** The octets of an EGPRS RLC data unit are not necessarily aligned with the octets of the RLC/MAC block. An octet of the EGPRS RLC data unit may thus span across the boundary between two consecutive octets of the RLC/MAC block.

The RLC/MAC block format convention of sub-clause 10.0b for EGPRS applies when the components of the EGPRS RLC data block are assembled into the RLC/MAC block.

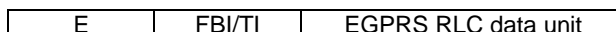

**Figure 10.3a.0.1: Components of the EGPRS RLC data block**

The size of the EGPRS RLC data unit for each of the channel coding schemes is shown in table 10.3a.0.1.

**Table 10.3a.0.1: EGPRS RLC data unit size**

Channel Coding Scheme	EGPRS RLC data unit size (N2) (octets)	Family
MCS-1	22	C
MCS-2	28	B
MCS-3 with padding	31	A padding
MCS-3	37	A padding / A
MCS-4	44	C
MCS-5	56	B
MCS-6 with padding	68	A padding
MCS-6	74	A
MCS-7	2x56	B
MCS-8	2x68	A padding
MCS-9	2x74	A
NOTE 1: The four families of EGPRS RLC data blocks C, B, A and A padding based on a common size basis (22, 28, 37 and 68 octets respectively) enable link adaptation retransmission as described in sub-clause 9.		
NOTE 2: Modulation and coding schemes of family A padding are compatible with Family A padding <sub>6</sub> defined for EGPRS <sub>2</sub> .		

The size of the RLC data unit for each of the channel coding schemes used in EGPRS<sub>2</sub> is shown in tables 10.3a.0.3, 10.3a.0.4, 10.3a.0.5, and 10.3a.0.6.

**Table 10.3a.0.3: RLC data unit size (EGPRS<sub>2</sub>-A downlink)**

Channel Coding Scheme	EGPRS RLC data unit size (N2) (octets)	Family
MCS-1	22	C
MCS-2 with padding	26	B padding <sub>2</sub>
MCS-2	28	B padding <sub>2</sub> / B
MCS-3 with padding	31	A padding <sub>6</sub>
MCS-3	37	A padding <sub>6</sub>
MCS-4	44	C
DAS-5	56	B
DAS-6	68	A padding <sub>6</sub>
MCS-6	74	NOTE 2
DAS-7	82	B padding <sub>2</sub>
MCS-7	2x56	B
DAS-8	2x56	B
MCS-8	2x68	A padding <sub>6</sub>
DAS-9	2x68	A padding <sub>6</sub>
DAS-10	2x82	B padding <sub>2</sub>
DAS-11	3x68	A padding <sub>6</sub>
DAS-12	3x82	B padding <sub>2</sub>
NOTE 1: The four families of RLC data blocks (C, B, A padding <sub>6</sub> , and B padding <sub>2</sub> ) based on a common size basis (22, 28, 68 and 82 octets respectively) enable link adaptation retransmission as described in sub-clause 9.		
NOTE 2: MCS-6 is also used for EGPRS <sub>2</sub> -A downlink (see sub-clause 5.2.1).		

**Table 10.3a.0.4: RLC data unit size (EGPRS2-B downlink)**

Channel Coding Scheme	EGPRS RLC data unit size (N2) (octets)	Family
MCS-1	22	C
MCS-2	28	B
MCS-3 with padding	31	A padding6
MCS-3	37	A padding6 / A
MCS-4	44	C
DAS-5	56	B
DBS-5	56	B
DAS-6	68	A padding6
MCS-6	74	A
DBS-6	74	A
MCS-7	2x56	B
DAS-8	2x56	B
DBS-7	2x56	B
MCS-8	2x68	A padding6
DAS-9	2x68	A padding6
MCS-9	2x74	A
DAS-10 with padding	2x74	A padding8
DBS-8	2x74	A
DBS-9	3x56	B
DAS-11	3x68	A padding6
DAS-12 with padding	3x74	A padding8
DBS-10	3x74	A
DBS-11	4x68	A padding6
DBS-12	4x74	A

NOTE 1: The five families of RLC data blocks (C, B, A, A padding6 and A padding8) based on a common size basis (22, 28, 37, 68 and 74 octets respectively) enable link adaptation retransmission as described in sub-clause 9.

**Table 10.3a.0.5: RLC data unit size (EGPRS2-A uplink)**

Channel Coding Scheme	EGPRS RLC data unit size (N2) (octets)	Family
MCS-1	22	C
MCS-2	28	B
MCS-3 with padding	27	A padding10
MCS-3	37	A padding10 / A
MCS-4	44	C
MCS-5	56	B
MCS-6 with padding	64	A padding10
MCS-6	74	A
UAS-7	2x56	B
UAS-8	2x64	A padding10
UAS-9	2x74	A
UAS-10	3x56	B
UAS-11	3x64	A padding10

NOTE 1: The four families of RLC data blocks (C, B, A, and A padding10) based on a common size basis (22, 28, 37 and 64 octets respectively) enable link adaptation retransmission as described in sub-clause 9.

**Table 10.3a.0.6: RLC data unit size (EGPRS2-B uplink)**

Channel Coding Scheme	EGPRS RLC data unit size (N2) (octets)	Family
MCS-1	22	C
MCS-2	28	B
MCS-3 with padding	31	A padding6
MCS-3	37	A padding6 / A
MCS-4	44	C
UBS-5	56	B
UBS-6 with padding	68	A padding6
UBS-6	74	A
UBS-7	2x56	B
UBS-8 with padding	2x68	A padding6
UBS-8	2x74	A
UBS-9	3x56	B
UBS-10 with padding	3x68	A padding6
UBS-10	3x74	A
UBS-11	4x68	A padding6
UBS-12	4x74	A

NOTE 1: The four families of RLC data blocks (C, B, A and A padding6) based on a common size basis (22, 28, 37 and 68 octets respectively) enable link adaptation retransmission as described in sub-clause 9.

### 10.3a.1 EGPRS downlink RLC data block

The EGPRS downlink RLC data blocks are formatted according to figure 10.3a.1.1.

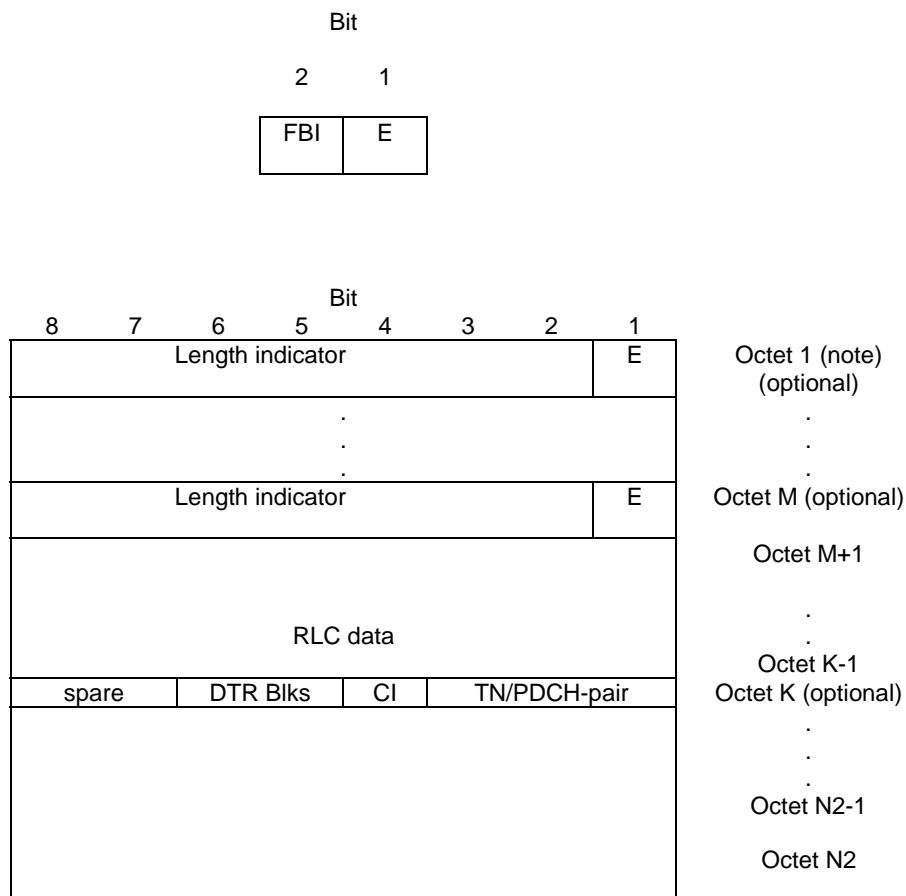

NOTE: If padding is used, then "Octet 1" shall be replaced by "Octet 7", see example in annex J.

**Figure 10.3a.1.1: EGPRS downlink RLC data block**

### 10.3a.2 EGPRS Uplink RLC data block

The EGPRS uplink RLC data block are formatted according to figure 10.3a.2.1.

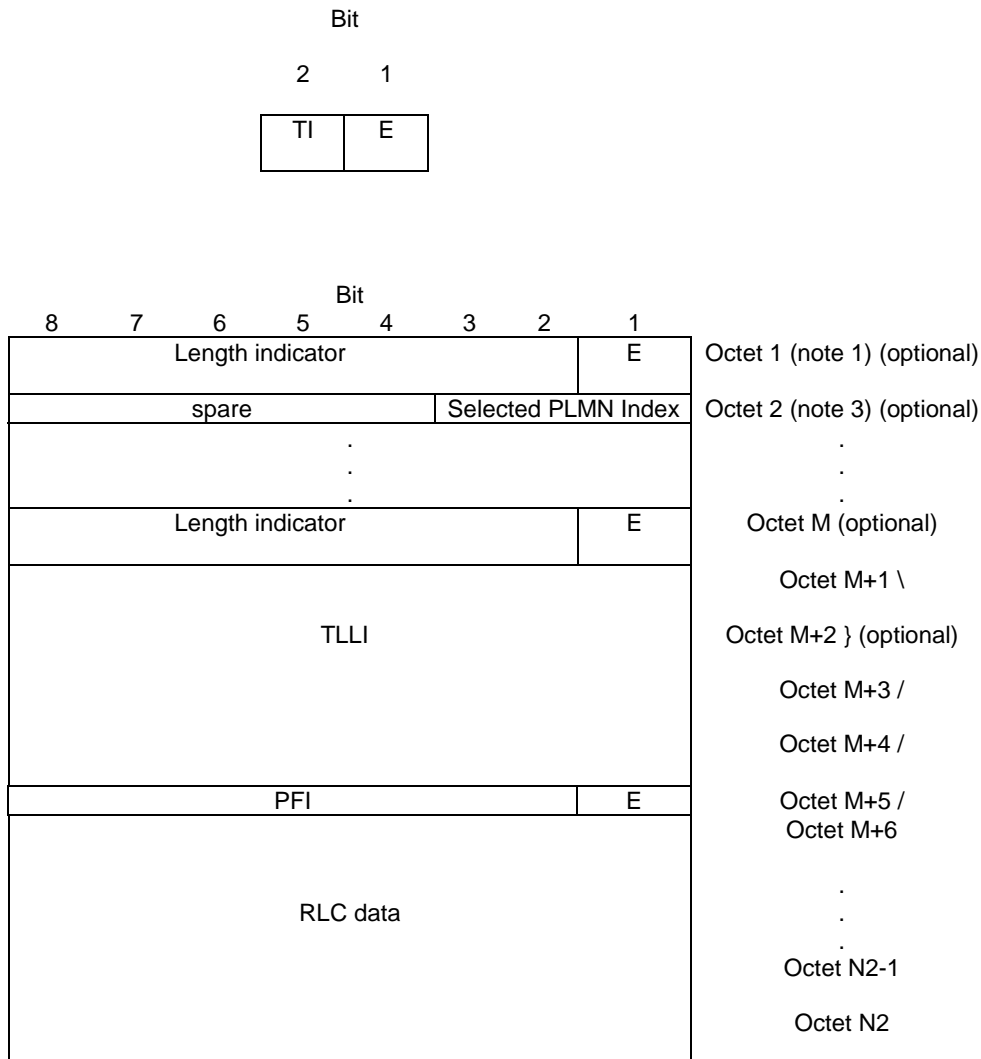

NOTE 1: If padding is used, then "Octet 1" shall be replaced by "Octet 7", see example in annex J.

NOTE 2: The field mapping convention for EGPRS (sub-clause 10.0b.3.2) applies. According to that, in particular regarding the TLLI field, the *least significant byte* of the TLLI value shall be mapped on octet M+1 and the *most significant byte* of the TLLI value shall be mapped on octet M+4 of the uplink EGPRS RLC data block.

NOTE 3: This octet is only included if the value of the first instance of the *Length indicator* in the RLC data block is 123.

**Figure 10.3a.2.1: Uplink EGPRS RLC data block**

### 10.3a.3 EGPRS Downlink RLC/MAC header

#### 10.3a.3.1 Header type 1: header for MCS-7, MCS-8 and MCS-9

For an EGPRS TBF without FANR activated, the EGPRS combined downlink RLC/MAC header for MCS-7, MCS-8 and MCS-9 (header type 1) shall be formatted according to figure 10.3a.3.1.1.

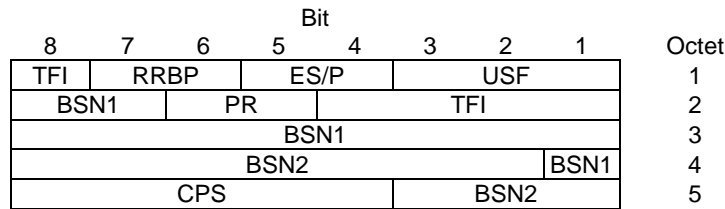

**Figure 10.3a.3.1.1: EGPRS downlink RLC data block header (FANR not activated) for MCS-7, MCS-8 and MCS-9**

For an EGPRS TBF with FANR activated and for an EGPRS2 TBF (see sub-clause 5.2.1), the downlink RLC/MAC header for MCS-7, MCS-8 and MCS-9 shall be formatted according to figure 10.3a.3.1.2.

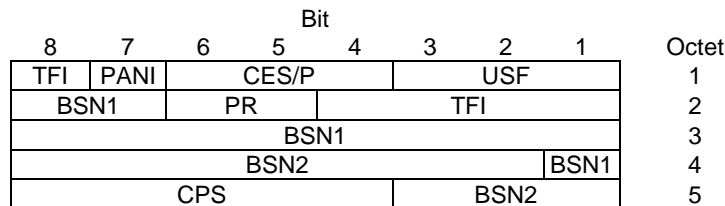

**Figure 10.3a.3.1.2: EGPRS (FANR activated) / EGPRS2 downlink RLC data block header**

For an EGPRS TBF without FANR activated in a DLMC configuration using an SNS of 8192, the EGPRS combined downlink RLC/MAC header for MCS-7, MCS-8 and MCS-9 (header type 1) shall be formatted according to figure 10.3a.3.1.3.

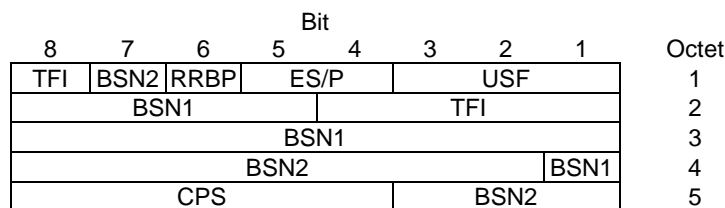

**Figure 10.3a.3.1.3: DLMC EGPRS downlink RLC data block header (FANR not activated) for MCS-7, MCS-8 and MCS-9**

For an EGPRS TBF with FANR activated in a DLMC configuration using an SNS of 8192 and for an EGPRS2 TBF in a DLMC configuration using an SNS of 8192, the downlink RLC/MAC header for MCS-7, MCS-8 and MCS-9 shall be formatted according to figure 10.3a.3.1.4.

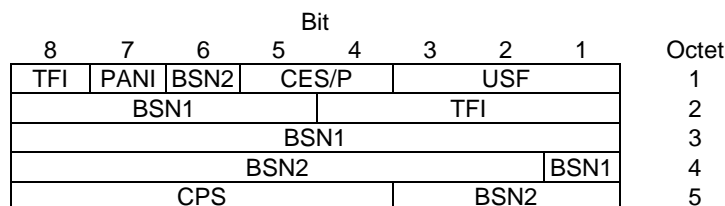
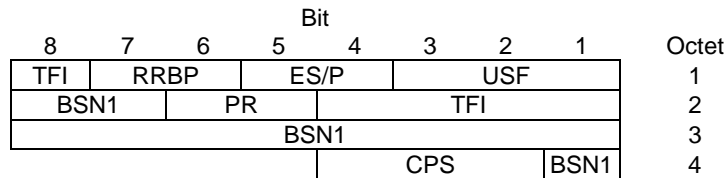

**Figure 10.3a.3.1.4: DLMC EGPRS (FANR activated) / DLMC EGPRS2 downlink RLC data block header for MCS-7, MCS-8 and MCS-9**

**10.3a.3.2 Header type 2: header for MCS-6, MCS-5, DAS-5, DAS-6 and DAS-7**

For an EGPRS TBF without FANR activated, the EGPRS combined downlink RLC/MAC header for MCS-5 and MCS-6 (header type 2) shall be formatted according to figure 10.3a.3.2.1.





**Figure 10.3a.3.2.1: EGPRS downlink RLC data block header (FANR not activated) for MCS-5 and MCS-6**

For an EGPRS TBF with FANR activated and for an EGPRS2 TBF (see sub-clause 5.2.1), the downlink RLC/MAC header for MCS-5 and MCS-6 shall be formatted according to figure 10.3a.3.2.2, whereas the RLC/MAC header for DAS-5, DAS-6 and DAS-7 shall be formatted as shown on figure 10.3a.3.2.2.

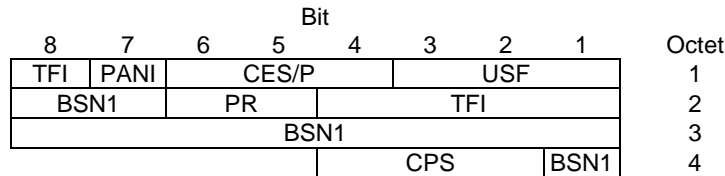

**Figure 10.3a.3.2.2: EGPRS (FANR activated) / EGPRS2 downlink RLC data block header for MCS-5, MCS-6, DAS-5, DAS-6 and DAS-7**

For an EGPRS TBF without FANR activated in a DLMC configuration using an SNS of 8192, the EGPRS combined downlink RLC/MAC header for MCS-5 and MCS-6 (header type 2) shall be formatted according to figure 10.3a.3.2.3.

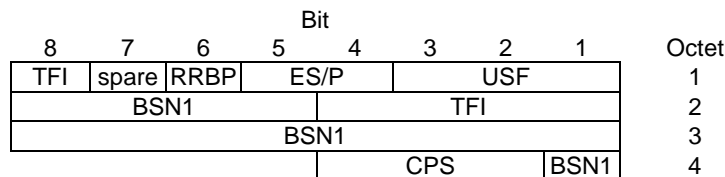

**Figure 10.3a.3.2.3: DLMC EGPRS downlink RLC data block header (FANR not activated) for MCS-5 and MCS-6**

For an EGPRS TBF with FANR activated in a DLMC configuration using an SNS of 8192 and for an EGPRS2 TBF in a DLMC configuration using an SNS of 8192, the downlink RLC/MAC header for MCS-5, MCS-6, DAS-5, DAS-6 and DAS-7 shall be formatted according to figure 10.3a.3.2.4.

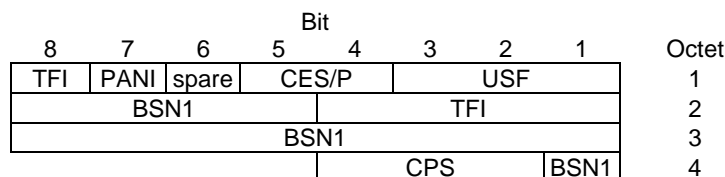

**Figure 10.3a.3.2.4: DLMC EGPRS (FANR activated) / DLMC EGPRS2 downlink RLC data block header for MCS-5, MCS-6, DAS-5, DAS-6 and DAS-7**

### 10.3a.3.3 Header type 3: header for MCS-4, MCS-3, MCS-2, MCS-1 and MCS-0 case

For an EGPRS TBF without FANR activated, the EGPRS combined downlink RLC/MAC header for MCS-1, MCS-2, MCS-3 and MCS-4 (header type 3) shall be formatted according to figure 10.3a.3.3.1.

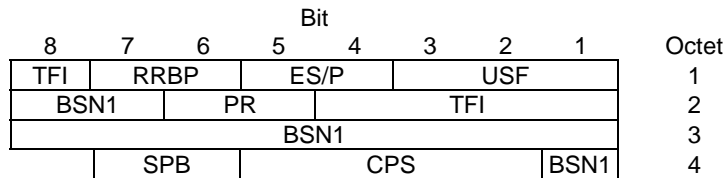

**Figure 10.3a.3.3.1: EGPRS downlink RLC data block header (FANR not activated) for MCS-1, MCS-2, MCS-3 and MCS-4**

For an EGPRS TBF with FANR activated and for an EGPRS2 TBF (see sub-clause 5.2.1), the downlink RLC/MAC header for MCS-1, MCS-2, MCS-3 and MCS-4 shall be formatted according to figure 10.3a.3.3.2.

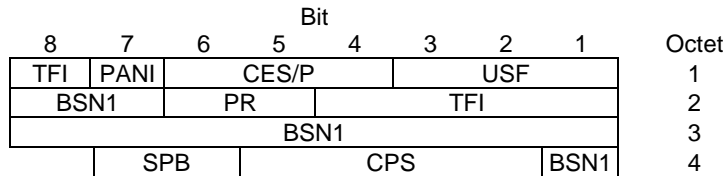

**Figure 10.3a.3.3.2: EGPRS (FANR activated) / EGPRS2 downlink RLC data block header for MCS-1, MCS-2, MCS-3 and MCS-4**

For a TBF in RTTI configuration, the downlink RLC/MAC control block header for MCS-0 shall be formatted as defined in figure 10.3a.3.3.3.

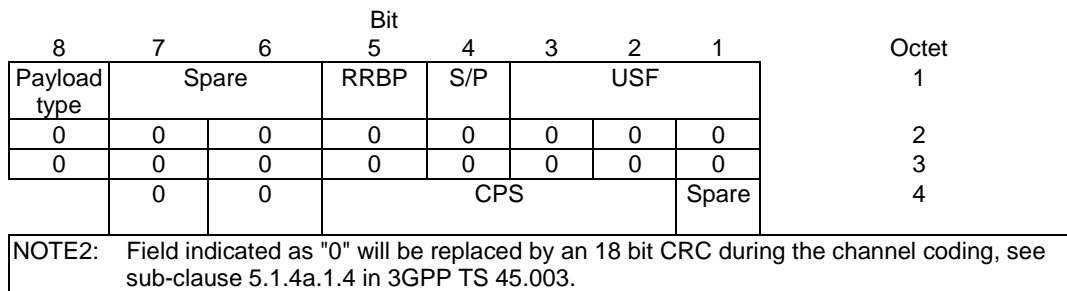

**Figure 10.3a.3.3.3: Downlink RLC/MAC control block header for MCS-0.**

For an EGPRS TBF without FANR activated in a DLMC configuration using an SNS of 8192, the EGPRS combined downlink RLC/MAC header for MCS-1, MCS-2, MCS-3 and MCS-4 (header type 3) shall be formatted according to figure 10.3a.3.3.4.

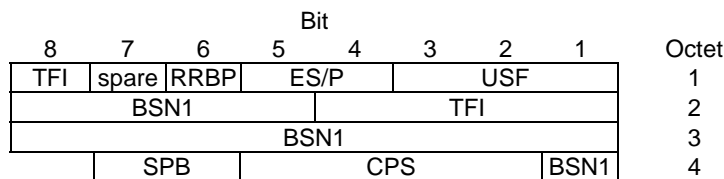

**Figure 10.3a.3.3.4: DLMC EGPRS downlink RLC data block header (FANR not activated) for MCS-1, MCS-2, MCS-3 and MCS-4**

For an EGPRS TBF with FANR activated in a DLMC configuration using an SNS of 8192 and for an EGPRS2 TBF in a DLMC configuration using an SNS of 8192, the downlink RLC/MAC header for MCS-1, MCS-2, MCS-3 and MCS-4 shall be formatted according to figure 10.3a.3.3.2.

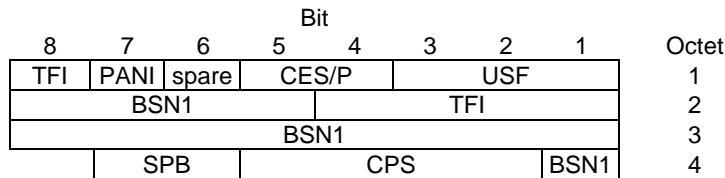

**Figure 10.3a.3.3.5: DLMC EGPRS (FANR activated) / DLMC EGPRS2 downlink RLC data block header for MCS-1, MCS-2, MCS-3 and MCS-4**

10.3a.3.4 Header type 4: header for DAS-8 and DAS-9

The combined downlink RLC/MAC header for DAS-8 and DAS-9 (header type 4) shall be formatted according to figure 10.3a.3.4.1.

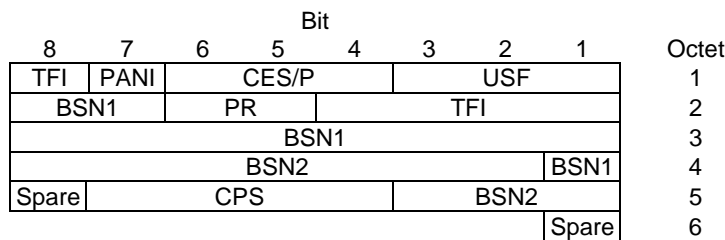

**Figure 10.3a.3.4.1: Combined downlink RLC data block header for DAS-8 and DAS-9.**

For an EGPRS2 TBF in a DLMC configuration using an SNS of 8192 the combined downlink RLC/MAC header for DAS-8 and DAS-9 (header type 4) shall be formatted according to figure 10.3a.3.4.2.

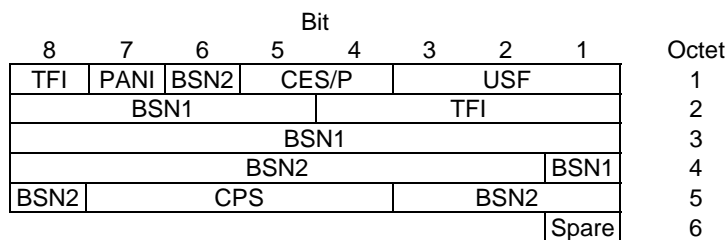

**Figure 10.3a.3.4.2: DLMC Combined downlink RLC data block header for DAS-8 and DAS-9.**

10.3a.3.5 Header type 5: header for DAS-11 and DAS-12

The combined downlink RLC/MAC header for DAS-11 and DAS-12 (header type 5) shall be formatted according to figure 10.3a.3.5.1.

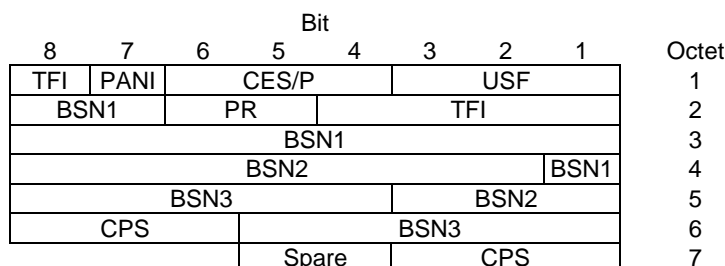

**Figure 10.3a.3.5.1: Combined downlink RLC data block header for DAS-11 and DAS-12.**

For an EGPRS2 TBF in a DLMC configuration using an SNS of 8192 the combined downlink RLC/MAC header for DAS-11 and DAS-12 (header type 5) shall be formatted according to figure 10.3a.3.5.2.

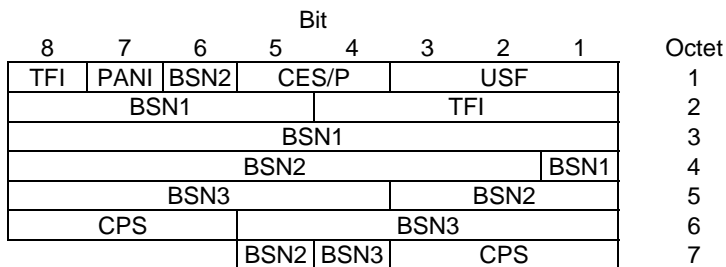

**Figure 10.3a.3.5.2: DLMC Combined downlink RLC data block header for DAS-11 and DAS-12.**

10.3a.3.6 Header type 6: header for DBS-5 and DBS-6

The combined downlink RLC/MAC header for DBS-5 and DBS-6 (header type 6) shall be formatted according to figure 10.3a.3.6.1.

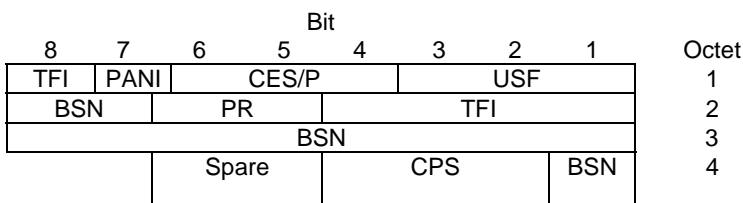

**Figure 10.3a.3.6.1: Combined downlink RLC data block header for DBS-5 and DBS-6.**

10.3a.3.7 Header type 7: header for DBS-7 and DBS-8

The combined downlink RLC/MAC header for DBS-7 and DBS-8 (header type 7) shall be formatted according to figure 10.3a.3.7.1.

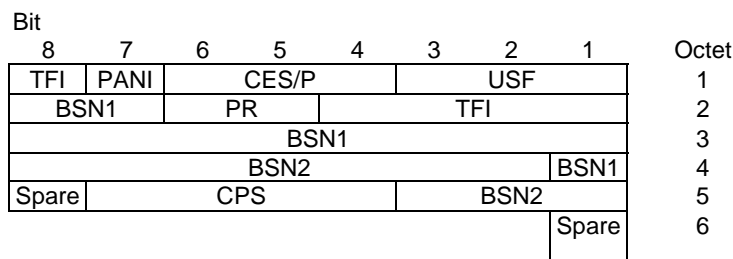

**Figure 10.3a.3.7.1: Combined downlink RLC data block header for DBS-7 and DBS-8.**

10.3a.3.8 Header type 8: header for DBS-9 and DBS-10

The combined downlink RLC/MAC header for DBS-9 and DBS-10 (header type 8) shall be formatted according to figure 10.3a.3.8.1.

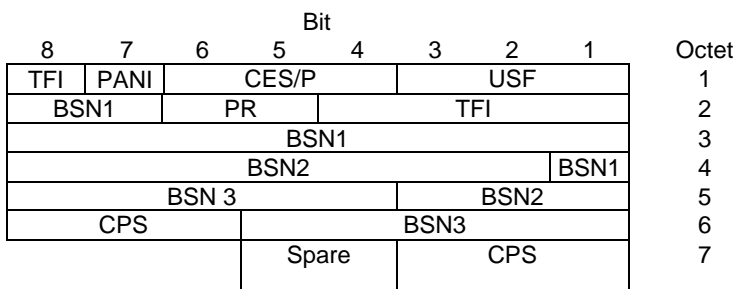

**Figure 10.3a.3.8.1: Combined downlink RLC data block header for DBS-9 and DBS-10.**

10.3a.3.9 Header type 9: header for DBS-11 and DBS-12

The combined downlink RLC/MAC header for DBS-11 and DBS-12 (header type 9) shall be formatted according to figure 10.3a.3.9.1.

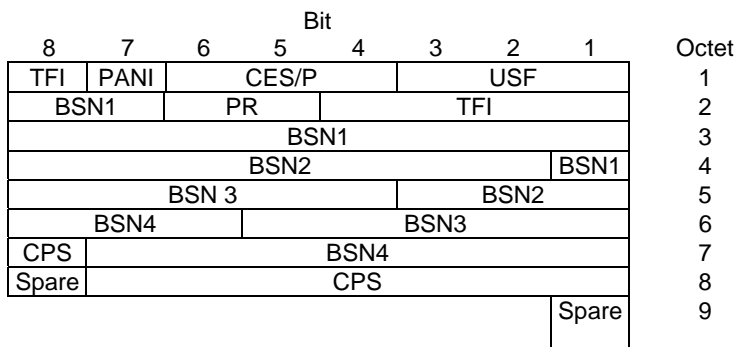

**Figure 10.3a.3.9.1: Combined downlink RLC data block header for DBS-11 and DBS-12.**

10.3a.3.10 Header type 10: header for DAS-10

The combined downlink RLC/MAC header for DAS-10 (header type 10) shall be formatted according to figure 10.3a.3.10.1.

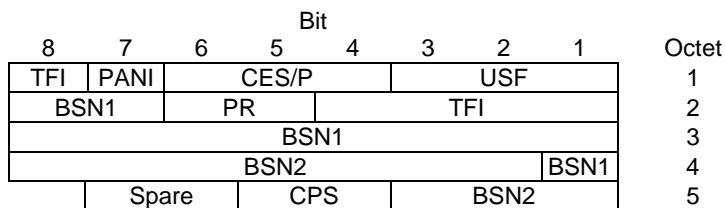

**Figure 10.3a.3.10.1: Combined downlink RLC data block header for DAS-10.**

For an EGPRS2 TBF in a DLMC configuration using an SNS of 8192 the combined downlink RLC/MAC header for DAS-10 (header type 10) shall be formatted according to figure 10.3a.3.10.2.

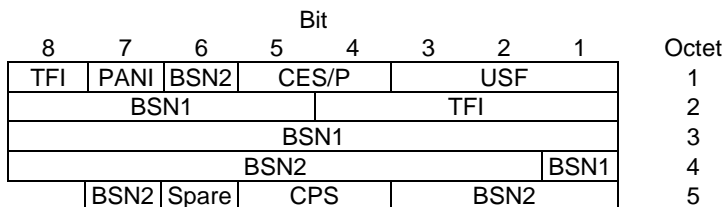
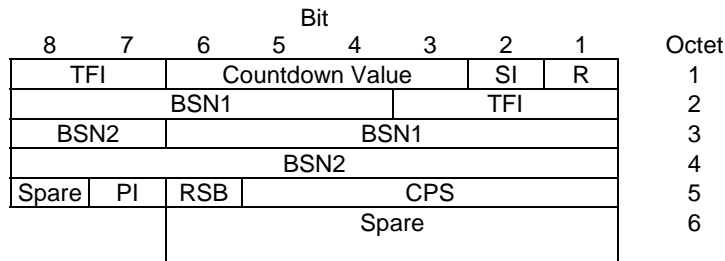

**Figure 10.3a.3.10.2: DLMC Combined downlink RLC data block header for DAS-10.**

### 10.3a.4 EGPRS Uplink RLC/MAC header

#### 10.3a.4.1 Header type 1: header for MCS-7, MCS-8 and MCS-9

The EGPRS combined uplink RLC/MAC header for MCS-7, MCS-8 and MCS-9 (header type 1) shall be formatted according to figure 10.3a.4.1.1.



**Figure 10.3a.4.1.1: EGPRS uplink RLC data block header (FANR not activated) for MCS-7, MCS-8 and MCS-9.**

For a EGPRS TBF with FANR activated, the uplink RLC/MAC header for MCS-7, MCS-8 and MCS-9 shall be formatted according to figure 10.3a.4.1.2.

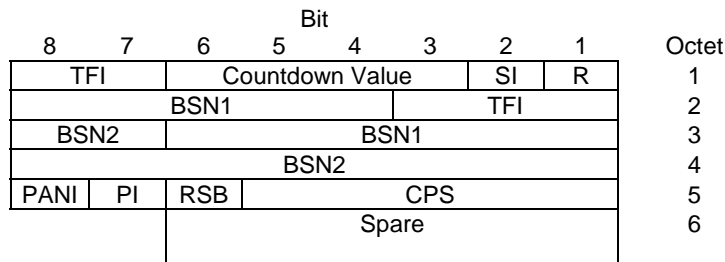

**Figure 10.3a.4.1.2: EGPRS uplink RLC data block header (FANR activated) for MCS-7, MCS-8 and MCS-9.**

#### 10.3a.4.2 Header type 2: header for MCS-6 and MCS-5

The EGPRS combined uplink RLC/MAC header for MCS-5 and MCS-6 (header type 2) shall be formatted according to figure 10.3a.4.2.1.

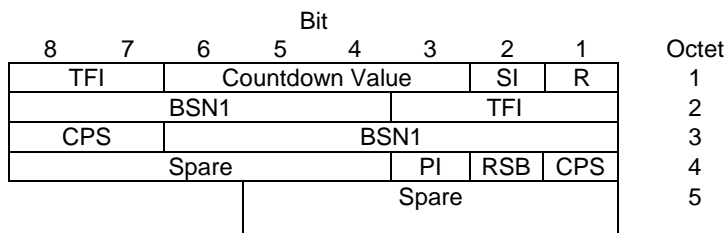

**Figure 10.3a.4.2.1: EGPRS uplink RLC data block header (FANR not activated) for MCS-5 and MCS-6**

For an EGPRS TBF with FANR activated and for an EGPRS2 TBF, the uplink RLC/MAC header for MCS-5 and MCS-6 shall be formatted according to figure 10.3a.4.2.2.

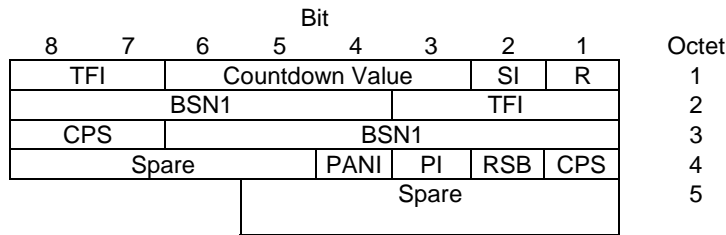

**Figure 10.3a.4.2.2: EGPRS (FANR activated) / EGPRS2 uplink RLC data block header for MCS-5 and MCS-6**

10.3a.4.3 Header type 3 : header for MCS-4, MCS-3, MCS-2 and MCS-1

The EGPRS combined uplink RLC/MAC header for MCS-1, MCS-2, MCS-3 and MCS-4 (header type 3) shall be formatted according to figure 10.3a.4.3.1.

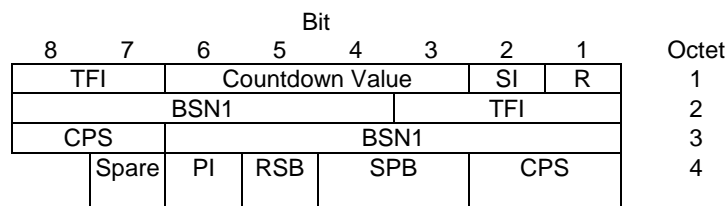

**Figure 10.3a.4.3.1: EGPRS uplink RLC data block header (FANR not activated) for MCS-1, MCS-2, MCS-3 and MCS-4**

For an EGPRS TBF with FANR activated and for an EGPRS2 TBF, the uplink RLC/MAC header for MCS-1, MCS-2, MCS-3 and MCS-4 shall be formatted according to figure 10.3a.4.3.2.

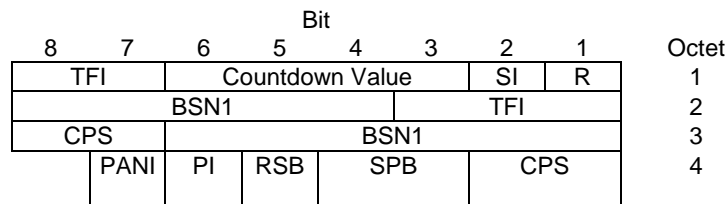

**Figure 10.3a.4.3.2: EGPRS (FANR activated)/EGPRS2 uplink RLC data block header for MCS-1, MCS-2, MCS-3 and MCS-4**

10.3a.4.4 Header type 4: header for UAS-7, UAS-8 and UAS-9

The combined uplink RLC/MAC header for UAS-7, UAS-8 and UAS-9 (header type 4) shall be formatted according to figure 10.3a.4.4.1.

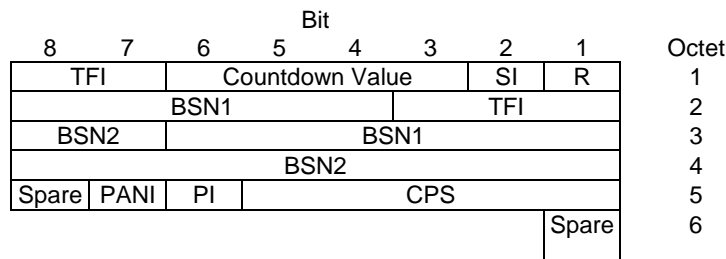

**Figure 10.3a.4.4.1: Combined uplink RLC data block header for UAS-7, UAS-8 and UAS-9.**

10.3a.4.5 Header type 5: header for UAS-10 and UAS-11

The combined uplink RLC/MAC header for UAS-10 and UAS-11 (header type 5) shall be formatted according to figure 10.3a.4.5.1.

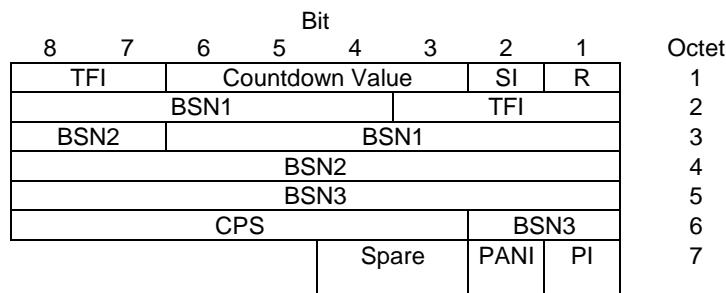

Figure 10.3a.4.5.1: Combined uplink RLC data block header for UAS-10, UAS-11.

10.3a.4.6 Header type 6: header for UBS-5 and UBS-6

The combined uplink RLC/MAC header for UBS-5 and UBS-6 (header type 6) shall be formatted according to figure 10.3a.4.6.1.

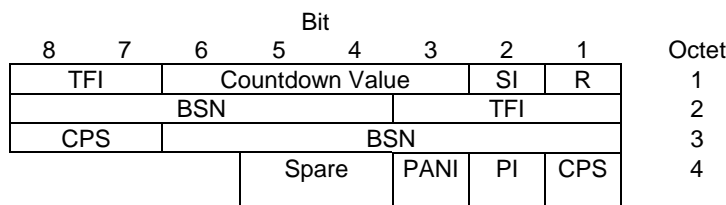

Figure 10.3a.4.6.1: Combined uplink RLC data block header for UBS-5, UBS-6.

10.3a.4.7 Header type 7: header for UBS-7 and UBS-8

The combined uplink RLC/MAC header for UBS-7 and UBS-8 (header type 7) shall be formatted according to figure 10.3a.4.7.1.

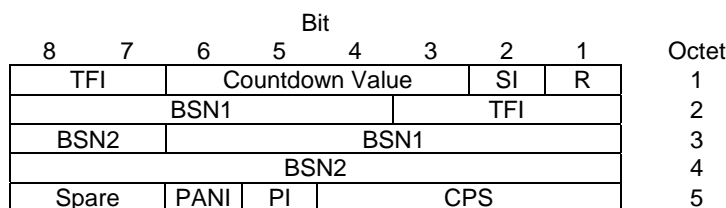
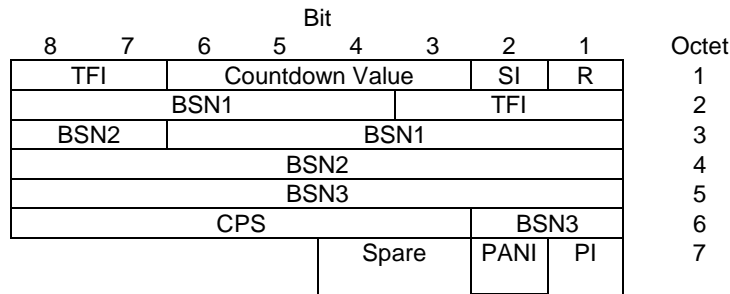

Figure 10.3a.4.7.1: Combined uplink RLC data block header for UBS-7, UBS-8.

10.3a.4.8 Header type 8: header for UBS-9 and UBS-10

The combined uplink RLC/MAC header for UBS-9 and UBS-10 (header type 8) shall be formatted according to figure 10.3a.4.8.1.

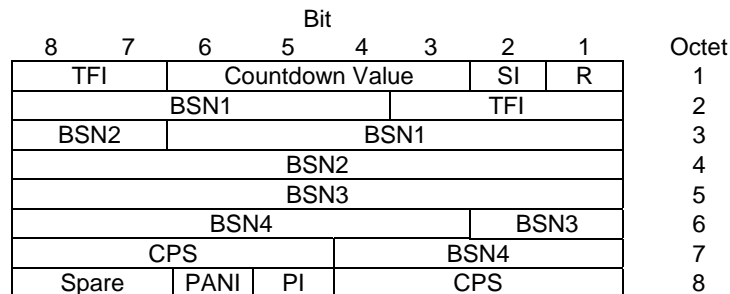



**Figure 10.3a.4.8.1: Combined uplink RLC data block header for UBS-9, UBS-10.**

10.3a.4.9 Header type 9: header for UBS-11 and UBS-12

The combined uplink RLC/MAC header for UBS-11 and UBS-12 (header type 9) shall be formatted according to figure 10.3a.4.9.1.

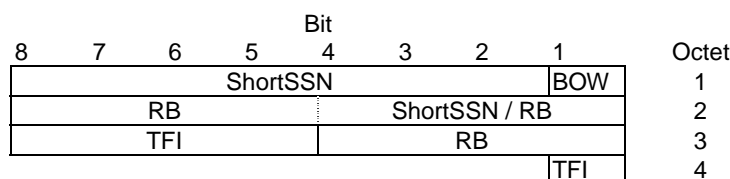

**Figure 10.3a.4.9.1: Combined uplink RLC data block header for UBS-11, UBS-12.**

10.3a.5 Piggy-backed Ack/Nack field (SSN-based)

When the SSN-based encoding is used (see sub-clause 9.1.14.1), the Piggy-backed Ack/Nack (PAN) field consists of a beginning of window (BOW), a short starting sequence number (ShortSSN), a reported bitmap (RB) and a temporary flow identifier (TFI) fields. In the downlink direction, the TFI field shall always include a valid value. In the uplink direction, the TFI field, or the combined TFI-eTFI fields (in case of a DLMC configuration and eTFI is assigned), shall include a valid value only if multiple TBF procedures or EMST or EMSR are supported by both the network and the mobile station; in all other cases, the bits of these fields shall be set to '0'. The length of the PAN field is 25 bits except if an eTFI is assigned in which case the length of the PAN is 28 bits in the uplink direction. The size of the ShortSSN field (defined in sub-clause 10.4.23) varies between 7 and 11 bits as shown in Figure 10.3a.5.1 except for a DLMC configuration where the size of the ShortSSN field varies between 11 and 13 bits (see sub-clause 10.4.12) in the uplink direction as shown in Figure 10.3a.5.2. The remaining bits in the PAN field are reserved for the reported bitmap with a size varying between 6 and 12 bits.

The order of bits is as for the UNCOMPRESSED\_RECEIVE\_BLOCK\_BITMAP field in the EGPRS Ack/Nack Description information element (see sub-clause 12.3.1) i.e. the lowest order bit in the RB field corresponds to the block with the sequence number from which the ShortSSN is derived.



**Figure 10.3a.5.1: Piggy-backed Ack/Nack field (SSN-based)**



ShortSSN		BOW	1	
RB	ShortSSN / RB	ShortSSN	2	
TFI		RB	3	
		eTFI	TFI	4

Figure 10.3a.5.2: Uplink Piggy-backed Ack/Nack field (SSN-based, eTFI assigned)

## 10.3a.6 Piggy-backed Ack/Nack field (Time-based)

When the Time-based encoding is used (see sub-clause 9.1.14.1), the Piggy-backed Ack/Nack (PAN) field consists of a 20 bits reported bitmap, as described in sub-clause 9.1.15, plus 5 bits set to '0'.

Codepoints are included so that the codepoints corresponding to blocks transmitted earlier are contained in the less significant bit(s) in the field.

Bit								
8	7	6	5	4	3	2	1	Octet
Reported bitmap								1
Reported bitmap (continued)								2
0	0	0	0	Reported bitmap (cont)				3
							0	4

Figure 10.3a.6.1: Piggy-backed Ack/Nack field (Time-based)

## 10.4 Header fields

### 10.4.1 Uplink state flag (USF) field

The USF field is sent in all downlink RLC/MAC blocks and indicates the owner or use of the next uplink radio block on the same timeslot (see 3GPP TS 45.002). The USF field is three bits in length and eight different USF values can be assigned, except on PCCCH, where the value '111' (USF=FREE) indicates that the corresponding uplink radio block contains PRACH.

### 10.4.2 Retry (R) bit

The Retry (R) bit shall indicate whether the mobile station transmitted the CHANNEL REQUEST message (see 3GPP TS 44.018), PACKET CHANNEL REQUEST message, EGPRS PACKET CHANNEL REQUEST message or MPRACH PACKET CHANNEL REQUEST message one time or more than one time during its most recent channel access. The mobile station shall send the same value for the R bit in each uplink RLC/MAC block of the TBF.

Table 10.4.2.1: Retry (R) bit

bit 1	Retry (R) bit
0	MS sent channel request message once
1	MS sent channel request message twice or more

### 10.4.3 Stall indicator (SI) bit

The Stall indicator (SI) bit indicates whether the mobile's RLC transmit window can advance (i.e. is not stalled) or can not advance (i.e. is stalled). The mobile station shall set the SI bit in all uplink RLC data blocks.

Table 10.4.3.1: Stall indicator bit

bit 2	Stall indicator
0	MS RLC transmit window is not stalled
1	MS RLC transmit window is stalled

## 10.4.4 Supplementary/Polling (S/P) Bit

The S/P bit is used to indicate whether the RRBP field is valid or not valid.

**Table 10.4.4.1: Supplementary/Polling (S/P) bit - GPRS case and RLC/MAC control**

bit 4	S/P
0	RRBP field is not valid
1	RRBP field is valid

### 10.4.4a EGPRS Supplementary/Polling (ES/P) Field

The ES/P field is used to indicate whether the RRBP field is valid or not valid, and what fields the next uplink control block shall contain (see further clause 9).

NOTE: The type of Ack/Nack bitmap requested by this field is applicable only when the next uplink control block is used to send an EGPRS PACKET DOWNLINK ACK/NACK, EGPRS PACKET DOWNLINK ACK/NACK TYPE 2, EGPRS PACKET DOWNLINK ACK/NACK TYPE 3, EGPRS PACKET DOWNLINK ACK/NACK DLDC or MBMS DOWNLINK ACK/NACK message.

**Table 10.4.4a.1: EGPRS Supplementary/Polling (ES/P) field (non-MBMS only)**

bits 5 4	ES/P
0 0	RRBP field is not valid (no Polling)
0 1	RRBP field is valid - Extended Ack/Nack bitmap type FPB
1 0	RRBP field is valid - Extended Ack/Nack bitmap type NPB
1 1	RRBP field is valid - Extended Ack/Nack bitmap type NPB, measurement report included

**Table 10.4.4a.1: EGPRS Supplementary/Polling (ES/P) field (MBMS only)**

bits 5 4	ES/P
0 0	RRBP field is not valid (no Polling)
0 1	RRBP field is valid - Extended Ack/Nack bitmap type FPB
1 0	RRBP field is valid - Extended Ack/Nack bitmap type NPB
1 1	RRBP field is valid - Extended Ack/Nack bitmap type NPB, neighbouring cell measurement reports included

### 10.4.4b Combined EGPRS Supplementary/Polling (CES/P) Field

The CES/P field is used to indicate what fields the next uplink radio block reserved by this field shall contain (see further clause 9). The single uplink block is defined by a delay relative to the first TDMA frame (N) of the downlink block containing the CES/P value. The procedures defined for transmission of a PACCH block to the network as described in sub-clause 10.4.5 shall apply.

If the mobile station is polled for a Piggy-backed Ack/Nack, in case EFTA is not used at the time the CES/P field is received, the mobile station shall transmit the uplink radio block on the same timeslot as the block where the CES/P field was received (in case of a BTTI configuration) or on the uplink PDCH pair corresponding to the downlink PDCH pair where the block containing the CES/P field was received (in case of an RTTI configuration). In case EFTA is used at the time the CES/P field is received, the mobile station shall transmit the uplink radio block according to the uplink radio block transmission order as described in Annex N regardless of the timeslot or PDCH pair where the block containing the CES/P field was received. The mobile station need not monitor the USF in the associated downlink RLC/MAC block appearing just before the uplink block it shall transmit. However, when Extended Dynamic Allocation or Shifted USF operation is used, the corresponding USF monitoring procedure shall apply as described in sub-clause 8.1.1.2.1 and sub-clause 8.1.1.2.4 respectively.

**Table 10.4.4b.1: Combined EGPRS Supplementary/Polling (CES/P) field**

bits 6 5 4	CES/P		
	Feedback	Reserved Block	
		BTTI	RTTI
0 0 0	no Polling	-	-
0 0 1	Extended Ack/Nack bitmap type FPB, and if there is enough room left in RLC/MAC block, channel quality report(s)	$(N+8 \text{ or } N+9) \bmod 2715648$	$(N+6 \text{ or } N+7) \bmod 2715648$
0 1 0	Extended Ack/Nack bitmap type FPB, and if there is enough room left in RLC/MAC block, channel quality report(s)	$(N+13) \bmod 2715648$	$(N+8 \text{ or } N+9) \bmod 2715648$
0 1 1	Piggy-backed Ack/Nack bitmap type FPB (see sub-clause 8.1.2.2) see note	$(N+8 \text{ or } N+9) \bmod 2715648$	$(N+6 \text{ or } N+7) \bmod 2715648$
1 0 0	Piggy-backed Ack/Nack bitmap type FPB (see sub-clause 8.1.2.2) see note	$(N+13) \bmod 2715648$	$(N+8 \text{ or } N+9) \bmod 2715648$
1 0 1	Channel quality report(s), and if there is enough room left in RLC/MAC block, Extended Ack/Nack bitmap type NPB	$(N+8 \text{ or } N+9) \bmod 2715648$	$(N+6 \text{ or } N+7) \bmod 2715648$
1 1 0	Channel quality report(s), and if there is enough room left in RLC/MAC block, Extended Ack/Nack bitmap type NPB	$(N+13) \bmod 2715648$	$(N+8 \text{ or } N+9) \bmod 2715648$
1 1 1	Extended Ack/Nack bitmap type NPB, and if there is enough room left in RLC/MAC block, channel quality report(s)	$(N+8 \text{ or } N+9) \bmod 2715648$	$(N+6 \text{ or } N+7) \bmod 2715648$
NOTE: In case where a PAN cannot be sent, the Extended Ack/Nack bitmap type NPB with measurement report included shall be transmitted on the allocated reserved block instead (see sub-clause 9.1.14.2).			

In case of a DLMC configuration using an SNS of 8192 the CES/P field within the RLC data block header (see sub-clause 10.3a.3.1, 10.3a.3.2, 10.3a.3.3, 10.3a.3.4, 10.3a.3.5 and 10.3a.3.10) is coded as shown in Table 10.4.4b.2.

**Table 10.4.4b.2: Combined EGPRS Supplementary/Polling (CES/P) field - DLMC Configuration**

bits 5 4	CES/P		
	Feedback	Reserved Block	
		BTTI	RTTI
0 0	no Polling	-	-
0 1	Extended Ack/Nack bitmap type FPB, and if there is enough room left in the RLC/MAC block, channel quality report(s)	$(N+8 \text{ or } N+9) \bmod 2715648$	$(N+6 \text{ or } N+7) \bmod 2715648$
1 0	Channel quality report(s), and if there is enough room left in the RLC/MAC block, Extended Ack/Nack bitmap type NPB	$(N+8 \text{ or } N+9) \bmod 2715648$	$(N+6 \text{ or } N+7) \bmod 2715648$
1 1	Piggy-backed Ack/Nack bitmap type FPB (see sub-clause 8.1.2.2) - see note	$(N+8 \text{ or } N+9) \bmod 2715648$	$(N+6 \text{ or } N+7) \bmod 2715648$
NOTE: In case where a PAN cannot be sent, the Extended Ack/Nack bitmap type NPB with channel quality report(s) included shall be transmitted on the allocated reserved block instead (see sub-clause 9.1.14.2).			

## 10.4.5 Relative Reserved Block Period (RRBP) field

The RRBP value specifies a single uplink block in which the mobile station shall transmit either a PACKET CONTROL ACKNOWLEDGEMENT message or a PACCH block to the network. If the RRBP field is received as part of an RLC/MAC block containing an RLC/MAC control block, the mobile station shall transmit a PACKET CONTROL ACKNOWLEDGEMENT message in the uplink radio block specified, except if:

- The received message is a Packet Paging Request, Packet Access Reject, or Packet Queuing Notification message, or
- It is specified elsewhere that the mobile station shall not respond to the polling request.

If the RRBP field is received as part of an RLC/MAC block containing an RLC/MAC control block containing a Packet Paging Request, Packet Access Reject, or Packet Queuing Notification message, or it is specified elsewhere that the mobile station shall not respond to the polling request, the mobile station shall ignore this RRBP field. The mobile station shall only react on RLC/MAC control blocks containing a valid RRBP field if the mobile station is addressed either in the downlink RLC/MAC control block header or in the control message itself. If the control message is segmented into more than one downlink RLC/MAC control blocks the mobile station shall react only on RLC/MAC control blocks containing a valid RRBP field if the mobile station is addressed in the downlink RLC/MAC control block header.

If the mobile station receives two or more RLC/MAC blocks containing an RLC/MAC control message with different RRBP values such that they specify the same uplink block, the mobile station shall transmit one PACKET CONTROL ACKNOWLEDGEMENT message in the specified uplink radio block.

If the RRBP field is received as part of a RLC/MAC block containing an RLC data block, the mobile station shall transmit a PACCH block in the specified uplink radio block. If the mobile station receives two or more RLC/MAC blocks containing an RLC data block with different RRBP values such they specify the same uplink radio block, the mobile station shall transmit one PACCH block in the specified uplink radio block.

If the mobile station receives an RLC data block and an RLC/MAC control block with different RRBP values such that they specify the same uplink radio block, the mobile station shall transmit a PACKET CONTROL ACKNOWLEDGEMENT message in the specified uplink radio block.

If no uplink control timeslot is assigned to the mobile station and EFTA is not used at the time the RRBP field is received, the mobile station shall transmit the uplink radio block on the same timeslot as the block where the RRBP was received (in case of a BTTI configuration) or on the corresponding uplink PDCH pair to the downlink PDCH pair where the block containing the RRBP was received (in case of a RTTI configuration). If EFTA is used at the time the RRBP field is received however, the mobile station shall instead transmit the uplink radio block according to the uplink radio block transmission order as described in Annex N regardless of the timeslot or PDCH-pair where the block containing the RRBP was received.

If an uplink control timeslot is assigned to the mobile station, the mobile station shall transmit the uplink radio block on this uplink control timeslot (in case of a BTTI configuration) or on the uplink PDCH pair the uplink control timeslot belongs to (in case of an RTTI configuration).

NOTE: In case of an RTTI configuration, the network should not poll the mobile station on a downlink PDCH pair for which no corresponding uplink PDCH pair exists.

After receiving an RLC/MAC block containing a valid RRBP field the mobile station need not monitor the USF in the associated downlink RLC/MAC block appearing just before the uplink block it shall transmit. However, when Extended Dynamic Allocation or Shifted USF operation is used, the corresponding USF monitoring procedure shall apply as described in sub-clause 8.1.1.2.1 and sub-clause 8.1.1.2.4 respectively.

A polled control message shall always be sent in the uplink block specified by the corresponding valid RRBP field of a downlink RLC/MAC control block, and not in any other uplink block that may be allocated to the mobile station.

The network should use the RRBP field to schedule the transmission of a PACKET CONTROL ACKNOWLEDGEMENT message or an uplink PACCH block as follows:

- For BTTI configuration, no later than the second last BTTI radio block,  $B(x-2) \bmod 12$ , before the first BTTI radio block,  $B(x)$ , where the mobile station shall be ready to transmit and receive using a new assignment.
- For RTTI configuration, no later than the second last RTTI radio block,  $B(x-2)_b$ , before the first RTTI radio block,  $B(x)_a$ , where the mobile station shall be ready to transmit and receive using a new assignment or no later than the second last RTTI radio block,  $B(x-1)_a$ , before the first RTTI radio block,  $B(x)_b$ , where the mobile station shall be ready to transmit and receive using a new assignment.

A mobile station that is scheduled an uplink block later than these times, may omit responding to the polling request. If a new assignment specifies an uplink TBF, and the TTI configuration of the uplink TBF specified is the same as the TTI configuration of the ongoing uplink TBF that this assignment modifies, or if the assignment does not specify any uplink TBF, then the mobile station may delay the access using the new assignment in order to respond to the polling request.

The network should not use the RRBP field to schedule the transmission of PACKET CONTROL ACKNOWLEDGEMENT messages or uplink PACCH blocks, in such way, that a mobile station has more than three such uplink blocks pending for transmission at any instant. A mobile station, that is scheduled such uplink blocks more frequent than that, may omit responding to the excessive polling requests.

The RRBP field shall be interpreted according to the TTI configuration in use for the mobile station on the PDCH (or on the PDCH pair) where the block containing the RRBP field is received at the time it is received, and, for a BTTI configuration, according to whether FANR is activated or not for the mobile station.

For TBFs with FANR not activated, Table 10.4.5.1 specifies the coding of the RRBP field indicating the number of TDMA frames the mobile station shall wait before transmitting the uplink RLC/MAC block. The delay is relative to the first TDMA frame (N) of the downlink block containing the RRBP value. For definition of TDMA frame numbering, see 3GPP TS 45.002.

**Table 10.4.5.1: Relative Reserved Block Period (RRBP) field (FANR not activated)**

bit 6-5/7-6	Full-rate PDCH uplink block with TDMA frame number	Full-rate PDCH uplink block with TDMA frame number (DLMC configuration with SNS 2048)	Half-rate PDCH uplink block with TDMA frame number
0 0	$(N+13) \bmod 2715648$	$(N+13) \bmod 2715648$	reserved
0 1	$(N+17 \text{ or } N+18) \bmod 2715648$	$(N+17 \text{ or } N+18) \bmod 2715648$	$(N+17 \text{ or } N+18) \bmod 2715648$
1 0	$(N+21 \text{ or } N+22) \bmod 2715648$	$(N+21 \text{ or } N+22) \bmod 2715648$	reserved
1 1	$(N+26) \bmod 2715648$	$(N+26) \bmod 2715648$	$(N+26) \bmod 2715648$

If the mobile station is operating on a half-rate PDCH and it receives an RLC/MAC block with a reserved RRBP value, it shall regard the RRBP field as not valid and shall ignore the polling.

For TBFs with FANR activated, Table 10.4.5.2 specifies the coding of the RRBP field indicating the number of TDMA frames the mobile station shall wait before transmitting the uplink RLC/MAC block.

**Table 10.4.5.2: Relative Reserved Block Period (RRBP) field (FANR activated)**

bit 6-5	PDCH uplink block with TDMA frame number (BTTI)	PDCH uplink block with TDMA frame number (RTTI)
0 0	$(N+13) \bmod 2715648$	reserved
0 1	$(N+8 \text{ or } N+9) \bmod 2715648$	$(N+8 \text{ or } N+9) \bmod 2715648$
1 0	reserved	$(N+6 \text{ or } N+7) \bmod 2715648$
1 1	reserved	reserved

NOTE: Table 10.4.5.2 only applies to RLC/MAC control blocks encoded using CS-1, while the CES/P field is used in case of polling in RLC data blocks (see sub-clause 10.4.4b).

In downlink RLC/MAC Control blocks encoded using MSC-0, a 1-bit RRBP is defined (see subclause 10.3a.3.3). In this case the number of TDMA frames the mobile station shall wait before transmitting the uplink RLC/MAC block is indicated in Table 10.4.5.3.

**Table 10.4.5.3: Relative Reserved Block Period (RRBP) field – 1 bit field**

bit 5	PDCH uplink block with TDMA frame number
0	$(N+6 \text{ or } N+7) \bmod 2715648$
1	$(N+8 \text{ or } N+9) \bmod 2715648$

In a DLMC configuration using an SNS of 8192 for a downlink TBF where FANR is not activated, Table 10.4.5.4 specifies the RRBP field in the RLC data block header (see sub-clause 10.3a.3.1, 10.3a.3.2 and 10.3a.3.3) by indicating the number of TDMA frames the mobile station shall wait before transmitting the uplink RLC/MAC block. The delay is

relative to the first TDMA frame (N) of the downlink block containing the RRBP value. For definition of TDMA frame numbering, see 3GPP TS 45.002.

**Table 10.4.5.4: Relative Reserved Block Period (RRBP) field (FANR not activated) – DLMC Configuration**

bit 6	PDCH uplink block with TDMA frame number
0	$(N+6 \text{ or } N+7) \bmod 2715648$
1	$(N+8 \text{ or } N+9) \bmod 2715648$

#### 10.4.5.1 Special requirements in dual transfer mode

If the mobile station in dual transfer mode is using PDCH/H, where the *exclusive allocation is required*, special requirements apply when the mobile station receives a valid RRBP field in a downlink RLC/MAC block:

- The mobile station may disregard the actual value of a valid RRBP field. The mobile station shall respond to the polling request at the TDMA frame number specified by one of the allowed RRBP values, regardless of which value that was actually received.
- If the mobile station receives more than one RLC/MAC block with a valid RRBP field, the mobile station shall respond to each one of the polling requests with a separate PACKET CONTROL ACKNOWLEDGEMENT message or PACCH block to the network.
- When the mobile station responds with a PACKET CONTROL ACKNOWLEDGEMENT message to a valid RRBP field, the mobile station shall use the RLC/MAC control block format. That is regardless of the CONTROL\_ACK\_TYPE parameter received in the broadcast information of the cell or the TYPE\_OF\_ACK parameter received in a PACKET POLLING REQUEST message.

If the mobile station in dual transfer mode is not using PDCH/H, the *normal requirements apply* when the mobile station receives a valid RRBP field in a downlink RLC/MAC block.

#### 10.4.6 Countdown Value (CV) field

The Countdown Value (CV) field is sent by the mobile station to allow the network to calculate the number of RLC data blocks remaining for the current uplink RLC entity. The CV value shall be calculated according to the process described in sub-clause 9.3.1. The CV field is 4 bits in length and is encoded as a binary number with range 0 to 15.

#### 10.4.7 Payload Type field

The Payload Type field shall indicate the type of data contained in remainder of the RLC/MAC block. The encoding of the Payload Type field is shown in table 10.4.7.1.

**Table 10.4.7.1: Payload Type field**

bit 8 7	Payload Type
0 0	RLC/MAC block contains an RLC data block
0 1	RLC/MAC block contains an RLC/MAC control block that does not include the optional octets of the RLC/MAC control header
1 0	In the downlink direction, the RLC/MAC block contains an RLC/MAC control block that includes the optional first octet of the RLC/MAC control header. In the uplink direction, this value is reserved.
1 1	Reserved. In this version of the protocol, the mobile station shall ignore all fields of the RLC/MAC block except for the USF field

In downlink RLC/MAC Control blocks encoded using MSC-0, the encoding of the Payload Type field is shown in table 10.4.7.2.

**Table 10.4.7.2: Payload Type field, MCS-0**

<b>bit 8</b>	<b>Payload Type</b>
0	RLC/MAC block contains an RLC/MAC control block that does not include the optional octets of the RLC/MAC control block message shown in figure 10.3.1.2
1	RLC/MAC block contains an RLC/MAC control block that includes at least the first optional octet of the RLC/MAC control block message shown in figure 10.3.1.2.

## 10.4.8 Final block indicator (FBI) bit

The Final block indicator (FBI) bit indicates that the downlink RLC data block is the last RLC data block of the downlink TBF.

**Table 10.4.8.1: Final block indicator bit**

<b>bit 1</b>	<b>Final block indicator</b>
0	Current block is not last RLC data block in TBF
1	Current block is last RLC data block in TBF

## 10.4.8a Coding and Puncturing Scheme indicator field (CPS)

In EGPRS header, the Coding and Puncturing Scheme indicator field is used to indicate the kind of channel coding and puncturing used for data blocks (see 3GPP TS 45.003).



## 10.4.8a.1 Header type 1

**Table 10.4.8a.1.1: Coding and Puncturing Scheme indicator field for Header type 1 in EGPRS TBF or downlink EGPRS2 TBF**

bits 54321	CPS
00000	(MCS-9/P1 ; MCS-9/P1) (see NOTE 2)
00001	(MCS-9/P1 ; MCS-9/P2) (see NOTE 2)
00010	(MCS-9/P1 ; MCS-9/P3) (see NOTE 2)
00100	(MCS-9/P2 ; MCS-9/P1) (see NOTE 2)
00101	(MCS-9/P2 ; MCS-9/P2) (see NOTE 2)
00110	(MCS-9/P2 ; MCS-9/P3) (see NOTE 2)
01000	(MCS-9/P3 ; MCS-9/P1) (see NOTE 2)
01001	(MCS-9/P3 ; MCS-9/P2) (see NOTE 2)
01010	(MCS-9/P3 ; MCS-9/P3) (see NOTE 2)
01011	(MCS-8/P1 ; MCS-8/P1)
01100	(MCS-8/P1 ; MCS-8/P2)
01101	(MCS-8/P1 ; MCS-8/P3)
01110	(MCS-8/P2 ; MCS-8/P1)
01111	(MCS-8/P2 ; MCS-8/P2)
10000	(MCS-8/P2 ; MCS-8/P3)
10001	(MCS-8/P3 ; MCS-8/P1)
10010	(MCS-8/P3 ; MCS-8/P2)
10011	(MCS-8/P3 ; MCS-8/P3)
10100	(MCS-7/P1 ; MCS-7/P1)
10101	(MCS-7/P1 ; MCS-7/P2)
10110	(MCS-7/P1 ; MCS-7/P3)
10111	(MCS-7/P2 ; MCS-7/P1)
11000	(MCS-7/P2 ; MCS-7/P2)
11001	(MCS-7/P2 ; MCS-7/P3)
11010	(MCS-7/P3 ; MCS-7/P1)
11011	(MCS-7/P3 ; MCS-7/P2)
11100	(MCS-7/P3 ; MCS-7/P3)
	All the other values are reserved for future use
NOTE 1: The bit numbering is relative to the field position.	
NOTE 2: MCS-9 shall only be used for an EGPRS TBF or for a downlink EGPRS2-B TBF.	

## 10.4.8a.2 Header type 2

In EGPRS and in EGPRS2-A uplink, the Coding and Puncturing Scheme indicator field indicates the kind of channel coding and puncturing used for data block as defined in table 10.4.8a.2.1.

**Table 10.4.8a.2.1: Coding and Puncturing Scheme indicator field for Header type 2 in EGPRS TBF or uplink EGPRS2-A TBF**

bits 321	(first block) CPS
000	MCS-6/P1
001	MCS-6/P2
010	MCS-6/P1 with 6 octets padding (see NOTE 2)
011	MCS-6/P2 with 6 octets padding (see NOTE 2)
100	MCS-5/P1
101	MCS-5/P2
110	MCS-6/P1 with 10 octets padding (see NOTE 3)
111	MCS-6/P2 with 10 octets padding (see NOTE 3)
NOTE 1: The bit numbering is relative to the field position.	
NOTE 2: MCS-6 with 6 octets padding shall only be used for an EGPRS TBF or, in case of an uplink EGPRS2-A TBF, for retransmission of blocks originally transmitted using EGPRS.	
NOTE 3: MSC-6 with 10 octets padding shall only be used for an uplink EGPRS2-A TBF or, in case of an uplink EGPRS TBF, for retransmission of blocks originally transmitted using EGPRS2-A.	

In EGPRS2 downlink, if the Downlink EGPRS Level assigned (see Table 11.2.7.1 and Table 12.10f.1) is EGPRS2-A, the Coding and Puncturing Scheme indicator field indicates the kind of channel coding and puncturing used for data block as defined in table 10.4.8a.2.2.

**Table 10.4.8a.2.2: Coding and Puncturing Scheme indicator field for Header type 2 in downlink EGPRS2-A TBF**

bits 321	CPS
000	MCS-6/P1 (see NOTE 2)
001	MCS-6/P2 (see NOTE 2)
010	DAS-5/P1
011	DAS-5/P2
100	DAS-6/P1
101	DAS-6/P2
110	DAS-7/P1
111	DAS-7/P2
NOTE 1: The bit numbering is relative to the field position.	
NOTE 2: In EGPRS2-A downlink, MCS-6 shall be used only for retransmissions of blocks originally transmitted using EGPRS.	

In EGPRS2 downlink, if the Downlink EGPRS Level assigned (see Table 11.2.7.1 and Table 12.10f.1) is EGPRS2-B, the Coding and Puncturing Scheme indicator field indicates the kind of channel coding and puncturing used for data block as defined in table 10.4.8a.2.3.

**Table 10.4.8a.2.3: Coding and Puncturing Scheme indicator field for Header type 2 in downlink EGPRS2-B TBF**

bits 321	CPS
000	MCS-6/P1
001	MCS-6/P2
010	DAS-5/P1
011	DAS-5/P2
100	DAS-6/P1
101	DAS-6/P2
	All the other values are reserved for future use
NOTE: The bit numbering is relative to the field position.	

## 10.4.8a.3 Header type 3

**Table 10.4.8a.3.1: Coding and Puncturing Scheme indicator field for Header type 3**

bits 4321	First block CPS
0000	MCS-4/P1
0001	MCS-4/P2
0010	MCS-4/P3
0011	MCS-3/P1
0100	MCS-3/P2
0101	MCS-3/P3
0110	MCS-3/P1 with padding
0111	MCS-3/P2 with padding
1000	MCS-3/P3 with padding
1001	MCS-2/P1
1010	MCS-2/P2
1011	MCS-1/P1
1100	MCS-1/P2
1101	MCS-2/P1 with padding (see NOTE 2)
1110	MCS-2/P2 with padding (see NOTE 2)
1111	MCS-0 (see NOTE 3)
NOTE 1: The bit numbering is relative to the field position.	
NOTE 2: MCS-2 with padding shall only be used for a downlink EGPRS2-A TBF or, in case of a downlink EGPRS TBF, for retransmissions of blocks originally transmitted using EGPRS2-A.	
NOTE 3: MCS-0 shall only be used for a downlink TBF.	

The number of padding octets for uplink is indicated by the SPB field (see sub clause 10.4.8b).

## 10.4.8a.4 Header type 4

In downlink, the Coding and Puncturing Scheme indicator field indicates the kind of channel coding and puncturing used for data block as defined in table 10.4.8a.4.1.

**Table 10.4.8a.4.1: Coding and Puncturing Scheme indicator field for Header type 4 in downlink**

bits 4321	CPS
0000	DAS-9/P1 ; DAS-9/P1
0001	DAS-9/P1 ; DAS-9/P2
0010	DAS-9/P1 ; DAS-9/P3
0011	DAS-9/P2 ; DAS-9/P1
0100	DAS-9/P2 ; DAS-9/P2
0101	DAS-9/P2 ; DAS-9/P3
0110	DAS-9/P3 ; DAS-9/P1
0111	DAS-9/P3 ; DAS-9/P2
1000	DAS-9/P3 ; DAS-9/P3
1001	DAS-8/P1 ; DAS-8/P1
1010	DAS-8/P1 ; DAS-8/P2
1011	DAS-8/P2 ; DAS-8/P1
1100	DAS-8/P2 ; DAS-8/P2
	All the other values are reserved for future use
NOTE: The bit numbering is relative to the field position.	

In uplink, the Coding and Puncturing Scheme indicator field indicates the kind of channel coding and puncturing used for data block as defined in table 10.4.8a.4.2.

**Table 10.4.8a.4.2: Coding and Puncturing Scheme indicator field for Header type 4 in uplink**

bits 54321	CPS
00000	(UAS-9/P1 ; UAS-9/P1)
00001	(UAS-9/P1 ; UAS-9/P2)
00010	(UAS-9/P1 ; UAS-9/P3)
00011	(UAS-9/P2 ; UAS-9/P1)
00100	(UAS-9/P2 ; UAS-9/P2)
00101	(UAS-9/P2 ; UAS-9/P3)
00110	(UAS-9/P3 ; UAS-9/P1)
00111	(UAS-9/P3 ; UAS-9/P2)
01000	(UAS-9/P3 ; UAS-9/P3)
01001	(UAS-8/P1 ; UAS-8/P1)
01010	(UAS-8/P1 ; UAS-8/P2)
01011	(UAS-8/P2 ; UAS-8/P1)
01100	(UAS-8/P2 ; UAS-8/P2)
01101	(UAS-7/P1 ; UAS-7/P1)
01110	(UAS-7/P1 ; UAS-7/P2)
01111	(UAS-7/P2 ; UAS-7/P1)
10000	(UAS-7/P2 ; UAS-7/P2)
	All the other values are reserved for future use
NOTE: The bit numbering is relative to the field position.	

### 10.4.8a.5 Header type 5

In downlink, the Coding and Puncturing Scheme indicator field indicates the kind of channel coding and puncturing used for data block as defined in table 10.4.8a.5.1 for EGPRS2-A TBF and 10.4.8a.5.1a for EGPRS2-B TBF and table 10.4.8a.5.3.

**Table 10.4.8a.5.1: Bit 6 of Coding and Puncturing Scheme indicator field for Header type 5 in downlink for EGPRS2-A TBF**

bit 6	CPS
0	DAS-11
1	DAS-12
NOTE: The bit numbering is relative to the field position.	

**Table 10.4.8a.5.1a: Bit 6 of Coding and Puncturing Scheme indicator field for Header type 5 in downlink for EGPRS2-B TBF**

bit 6	CPS
0	DAS-11
1	DAS-12 with padding
NOTE: The bit numbering is relative to the field position.	

For DAS-12 with padding, the first 8 data octets of the RLC data block are padded with zeros.

In uplink, the Coding and Puncturing Scheme indicator field indicates the kind of channel coding and puncturing used for data block as defined in table 10.4.8a.5.2 and table 10.4.8a.5.3.

**Table 10.4.8a.5.2: Bit 6 of Coding and Puncturing Scheme indicator field for Header type 5 in uplink**

bit 6	CPS
0	UAS-10
1	UAS-11
NOTE: The bit numbering is relative to the field position.	

**Table 10.4.8a.5.3: Bits 1 to 5 of Coding and Puncturing Scheme indicator field for Header type 5 common for downlink and uplink**

bits 54321	CPS
00000	(P1 ; P1 ; P1)
00001	(P1 ; P1 ; P2)
00010	(P1 ; P1 ; P3)
00011	(P1 ; P2 ; P1)
00100	(P1 ; P2 ; P2)
00101	(P1 ; P2 ; P3)
00110	(P1 ; P3 ; P1)
00111	(P1 ; P3 ; P2)
01000	(P1 ; P3 ; P3)
01001	(P2 ; P1 ; P1)
01010	(P2 ; P1 ; P2)
01011	(P2 ; P1 ; P3)
01100	(P2 ; P2 ; P1)
01101	(P2 ; P2 ; P2)
01110	(P2 ; P2 ; P3)
01111	(P2 ; P3 ; P1)
10000	(P2 ; P3 ; P2)
10001	(P2 ; P3 ; P3)
10010	(P3 ; P1 ; P1)
10011	(P3 ; P1 ; P2)
10100	(P3 ; P1 ; P3)
10101	(P3 ; P2 ; P1)
10110	(P3 ; P2 ; P2)
10111	(P3 ; P2 ; P3)
11000	(P3 ; P3 ; P1)
11001	(P3 ; P3 ; P2)
11010	(P3 ; P3 ; P3)
	All the other values are reserved for future use
NOTE: The bit numbering is relative to the field position.	

### 10.4.8a.6 Header type 6

In downlink, the Coding and Puncturing Scheme indicator field indicates the kind of channel coding and puncturing used for data block as defined in table 10.4.8a.6.1.

**Table 10.4.8a.6.1: Coding and Puncturing Scheme indicator field for Header type 6 in downlink**

bits 321	CPS
000	DBS-5 P1
001	DBS-5 P2
010	DBS-6 P1
011	DBS-6 P2
	All the other values are reserved for future use
NOTE: The bit numbering is relative to the field position.	

In uplink, the Coding and Puncturing Scheme indicator field indicates the kind of channel coding and puncturing used for data block as defined in table 10.4.8a.6.2.

**Table 10.4.8a.6.2: Coding and Puncturing Scheme indicator field for Header type 6 in uplink**

bits 321	CPS
000	UBS-5 P1
001	UBS-5 P2
010	UBS-6 P1
011	UBS-6 P2
100	UBS-6 P1 with padding
101	UBS-6 P2 with padding
	All the other values are reserved for future use
NOTE: The bit numbering is relative to the field position.	

### 10.4.8a.7 Header type 7

In downlink, the Coding and Puncturing Scheme indicator field indicates the kind of channel coding and puncturing used for data block as defined in table 10.4.8a.7.1 and table 10.4.8a.7.3.

**Table 10.4.8a.7.1: Bit 4 of Coding and Puncturing Scheme indicator field for Header type 7 in downlink**

bit 4	CPS
0	DBS-7
1	DBS-8
NOTE: The bit numbering is relative to the field position.	

In uplink, the Coding and Puncturing Scheme indicator field indicates the kind of channel coding and puncturing used for data block as defined in table 10.4.8a.7.2 and table 10.4.8a.7.3.

**Table 10.4.8a.7.2: Bit 4 of Coding and Puncturing Scheme indicator field for Header type 7 in downlink**

bit 4	CPS
0	UBS-7
1	UBS-8
NOTE: The bit numbering is relative to the field position.	

**Table 10.4.8a.7.3: Bit 1 and 3 of Coding and Puncturing Scheme indicator field for Header type 7 common for downlink and uplink**

bits 321	CPS
000	(P1 ; P1)
001	(P1 ; P2)
010	(P2 ; P1)
011	(P2 ; P2)
100	(P1 ; P1) with padding
101	(P1 ; P2) with padding
110	(P2 ; P1) with padding
111	(P2 ; P2) with padding
NOTE: The bit numbering is relative to the field position.	

### 10.4.8a.8 Header type 8

The Coding and Puncturing Scheme indicator field indicates the kind of channel coding and puncturing used for data block as defined in table 10.4.8a.8.1 for uplink and table 10.4.8a.8.2 for downlink. DBS-9 and DBS-10, and also UBS-9 and UBS-10 use different modulations hence the CPS field need not distinguish between these coding schemes.

**Table 10.4.8a.8.1: Coding and Puncturing Scheme indicator field for Header type 8 in uplink**

bits 654321	CPS
000000	(P1 ; P1 ; P1)
000001	(P1 ; P1 ; P2)
000010	(P1 ; P1 ; P3)
000100	(P1 ; P2 ; P1)
000101	(P1 ; P2 ; P2)
000110	(P1 ; P2 ; P3)
001000	(P1 ; P3 ; P1)
001001	(P1 ; P3 ; P2)
001010	(P1 ; P3 ; P3)
001011	(P2 ; P1 ; P1)
001100	(P2 ; P1 ; P2)
001101	(P2 ; P1 ; P3)
001110	(P2 ; P2 ; P1)
001111	(P2 ; P2 ; P2)
010000	(P2 ; P2 ; P3)
010001	(P2 ; P3 ; P1)
010010	(P2 ; P3 ; P2)
010011	(P2 ; P3 ; P3)
010100	(P3 ; P1 ; P1)
010101	(P3 ; P1 ; P2)
010110	(P3 ; P1 ; P3)
010111	(P3 ; P2 ; P1)
011000	(P3 ; P2 ; P2)
011001	(P3 ; P2 ; P3)
011010	(P3 ; P3 ; P1)
011011	(P3 ; P3 ; P2)
011100	(P3 ; P3 ; P3)
011101	(P1 ; P1 ; P1) with padding
011110	(P1 ; P1 ; P2) with padding
011111	(P1 ; P1 ; P3) with padding
100000	(P1 ; P2 ; P1) with padding
100001	(P1 ; P2 ; P2) with padding
100010	(P1 ; P2 ; P3) with padding
100011	(P1 ; P3 ; P1) with padding
100100	(P1 ; P3 ; P2) with padding
100101	(P1 ; P3 ; P3) with padding
100110	(P2 ; P1 ; P1) with padding
100111	(P2 ; P1 ; P2) with padding
101000	(P2 ; P1 ; P3) with padding
101001	(P2 ; P2 ; P1) with padding
101010	(P2 ; P2 ; P2) with padding
101011	(P2 ; P2 ; P3) with padding
101100	(P2 ; P3 ; P1) with padding
101101	(P2 ; P3 ; P2) with padding
101110	(P2 ; P3 ; P3) with padding
101111	(P3 ; P1 ; P1) with padding
110000	(P3 ; P1 ; P2) with padding
110001	(P3 ; P1 ; P3) with padding
110010	(P3 ; P2 ; P1) with padding
110011	(P3 ; P2 ; P2) with padding
110100	(P3 ; P2 ; P3) with padding
110101	(P3 ; P3 ; P1) with padding
110110	(P3 ; P3 ; P2) with padding
110111	(P3 ; P3 ; P3) with padding
	All the other values are reserved for future use
NOTE: The bit numbering is relative to the field position.	



**Table 10.4.8a.8.2: Coding and Puncturing Scheme indicator field for Header type 8 in downlink**

bits 654321	CPS
000000	(P1 ; P1 ; P1)
000001	(P1 ; P1 ; P2)
000010	(P1 ; P1 ; P3)
000100	(P1 ; P2 ; P1)
000101	(P1 ; P2 ; P2)
000110	(P1 ; P2 ; P3)
001000	(P1 ; P3 ; P1)
001001	(P1 ; P3 ; P2)
001010	(P1 ; P3 ; P3)
001011	(P2 ; P1 ; P1)
001100	(P2 ; P1 ; P2)
001101	(P2 ; P1 ; P3)
001110	(P2 ; P2 ; P1)
001111	(P2 ; P2 ; P2)
010000	(P2 ; P2 ; P3)
010001	(P2 ; P3 ; P1)
010010	(P2 ; P3 ; P2)
010011	(P2 ; P3 ; P3)
010100	(P3 ; P1 ; P1)
010101	(P3 ; P1 ; P2)
010110	(P3 ; P1 ; P3)
010111	(P3 ; P2 ; P1)
011000	(P3 ; P2 ; P2)
011001	(P3 ; P2 ; P3)
011010	(P3 ; P3 ; P1)
011011	(P3 ; P3 ; P2)
011100	(P3 ; P3 ; P3)
	All the other values are reserved for future use
NOTE:	The bit numbering is relative to the field position.

### 10.4.8a.9 Header type 9

In downlink, the Coding and Puncturing Scheme indicator field indicates the kind of channel coding and puncturing used for data block as defined in table 10.4.8a.9.1 and table 10.4.8a.9.3.

**Table 10.4.8a.9.1: Bit 8 of Coding and Puncturing Scheme indicator field for Header type 9 in downlink**

bit 8	CPS
0	DBS-11
1	DBS-12
NOTE:	The bit numbering is relative to the field position.

In uplink, the Coding and Puncturing Scheme indicator field indicates the kind of channel coding and puncturing used for data block as defined in table 10.4.8a.9.2 and table 10.4.8a.9.3.

**Table 10.4.8a.9.2: Bit 8 of Coding and Puncturing Scheme indicator field for Header type 9 in uplink**

bit 8	CPS
0	UBS-11
1	UBS-12
NOTE:	The bit numbering is relative to the field position.

**Table 10.4.8a.9.3: Bits 1 to 7 of Coding and Puncturing Scheme indicator field for Header type 9 common for downlink and uplink**

bits 7654321	CPS
0000000	(P1 ; P1 ; P1; P1)
0000001	(P1 ; P1 ; P1; P2)
0000010	(P1 ; P1 ; P1; P3)
0000011	(P1 ; P1 ; P2; P1)
0000100	(P1 ; P1 ; P2; P2)
0000101	(P1 ; P1 ; P2; P3)
0000110	(P1 ; P1 ; P3; P1)
0000111	(P1 ; P1 ; P3; P2)
0001000	(P1 ; P1 ; P3; P3)
0001001	(P1 ; P2 ; P1; P1)
0001010	(P1 ; P2 ; P1; P2)
0001011	(P1 ; P2 ; P1; P3)
0001100	(P1 ; P2 ; P2; P1)
0001101	(P1 ; P2 ; P2; P2)
0001110	(P1 ; P2 ; P2; P3)
0001111	(P1 ; P2 ; P3; P1)
0010000	(P1 ; P2 ; P3; P2)
0010001	(P1 ; P2 ; P3; P3)
0010010	(P1 ; P3 ; P1; P1)
0010011	(P1 ; P3 ; P1; P2)
0010100	(P1 ; P3 ; P1; P3)
0010101	(P1 ; P3 ; P2; P1)
0010110	(P1 ; P3 ; P2; P2)
0010111	(P1 ; P3 ; P2; P3)
0011000	(P1 ; P3 ; P3; P1)
0011001	(P1 ; P3 ; P3; P2)
0011010	(P1 ; P3 ; P3; P3)
0011011	(P2 ; P1 ; P1; P1)
0011100	(P2 ; P1 ; P1; P2)
0011101	(P2 ; P1 ; P1; P3)
0011110	(P2 ; P1 ; P2; P1)
0011111	(P2 ; P1 ; P2; P2)
0100000	(P2 ; P1 ; P2; P3)
0100001	(P2 ; P1 ; P3; P1)
0100010	(P2 ; P1 ; P3; P2)
0100011	(P2 ; P1 ; P3; P3)
0100100	(P2 ; P2 ; P1; P1)
0100101	(P2 ; P2 ; P1; P2)
0100110	(P2 ; P2 ; P1; P3)
0100111	(P2 ; P2 ; P2; P1)
0101000	(P2 ; P2 ; P2; P2)
0101001	(P2 ; P2 ; P2; P3)
0101010	(P2 ; P2 ; P3; P1)
0101011	(P2 ; P2 ; P3; P2)
0101100	(P2 ; P2 ; P3; P3)
0101101	(P2 ; P3 ; P1; P1)
0101110	(P2 ; P3 ; P1; P2)
0101111	(P2 ; P3 ; P1; P3)
0110000	(P2 ; P3 ; P2; P1)
0110001	(P2 ; P3 ; P2; P2)
0110010	(P2 ; P3 ; P2; P3)
0110011	(P2 ; P3 ; P3; P1)
0110100	(P2 ; P3 ; P3; P2)
0110101	(P2 ; P3 ; P3; P3)
0110110	(P3 ; P1 ; P1; P1)
0110111	(P3 ; P1 ; P1; P2)
0111000	(P3 ; P1 ; P1; P3)
0111001	(P3 ; P1 ; P2; P1)
0111010	(P3 ; P1 ; P2; P2)
0111011	(P3 ; P1 ; P2; P3)

0111100	(P3 ; P1 ; P3; P1)
0111101	(P3 ; P1 ; P3; P2)
0111110	(P3 ; P1 ; P3; P3)
0111111	(P3 ; P2 ; P1; P1)
1000000	(P3 ; P2 ; P1; P2)
1000001	(P3 ; P2 ; P1; P3)
1000010	(P3 ; P2 ; P2; P1)
1000011	(P3 ; P2 ; P2; P2)
1000100	(P3 ; P2 ; P2; P3)
1000101	(P3 ; P2 ; P3; P1)
1000110	(P3 ; P2 ; P3; P2)
1000111	(P3 ; P2 ; P3; P3)
1001000	(P3 ; P3 ; P1; P1)
1001001	(P3 ; P3 ; P1; P2)
1001010	(P3 ; P3 ; P1; P3)
1001011	(P3 ; P3 ; P2; P1)
1001100	(P3 ; P3 ; P2; P2)
1001101	(P3 ; P3 ; P2; P3)
1001110	(P3 ; P3 ; P3; P1)
1001111	(P3 ; P3 ; P3; P2)
1010000	(P3 ; P3 ; P3; P3)
	All other values are reserved for future use

#### 10.4.8a.10 Header type 10

In downlink, the Coding and Puncturing Scheme indicator field indicates the kind of channel coding and puncturing used for data block as defined in table 10.4.8a.10.1 for EGPRS2-A TBF and in table 10.4.8a.10.2 for EGPRS2-B TBF.

**Table 10.4.8a.10.1: Coding and Puncturing Scheme indicator field for Header type 10 in downlink EGPRS2-A TBF**

bits 21	CPS
00	DAS-10/P1 ; DAS-10/P1
01	DAS-10/P1 ; DAS-10/P2
10	DAS-10/P2 ; DAS-10/P1
11	DAS-10/P2 ; DAS-10/P2

NOTE: The bit numbering is relative to the field position.

**Table 10.4.8a.10.2: Coding and Puncturing Scheme indicator field for Header type 10 in downlink EGPRS2-B TBF**

bits 21	CPS
00	DAS-10/P1 ; DAS-10/P1 both with padding
01	DAS-10/P1 ; DAS-10/P2 both with padding
10	DAS-10/P2 ; DAS-10/P1 both with padding
11	DAS-10/P2 ; DAS-10/P2 both with padding

NOTE: The bit numbering is relative to the field position.

For DAS-10 with padding, the first 8 data octets of the RLC data block are padded with zeros.

### 10.4.8b Split Block indicator field (SPB)

In EGPRS uplink and EGPRS2 uplink, the Split Block indicator is only used in header type 3 to indicate if some user data is retransmitted using 2 block resegmentation (see clause 9).

**Table 10.4.8b.1: Split Block indicator field (uplink)**

bits 2 1	SPB
0 0	No retransmission
0 1	Retransmission - first part of block with 10 octet padding
1 0	Retransmission - first part of block with no padding or 6 octet padding
1 1	Retransmission - second part of block
NOTE: The bit numbering is relative to the field position.	

In case of EGPRS, 10 octet padding shall be used only for retransmissions of blocks originally transmitted using EGPRS2-A. In case of EGPRS2-A, 6 octet padding shall be used only for retransmissions of blocks originally transmitted using EGPRS.

In EGPRS downlink and EGPRS2 downlink, the Split Block indicator is only used in header type 3 to indicate if some user data is retransmitted using 2 or 3 block resegmentation (see clause 9).

**Table 10.4.8b.2: Split Block indicator field (downlink)**

bits 2 1	SPB
0 0	No retransmission
0 1	Retransmission - third part of block (Note 2)
1 0	Retransmission - first part of block
1 1	Retransmission - second part of block
NOTE 1: The bit numbering is relative to the field position.	
NOTE 2: In EGPRS downlink this code point is only used when retransmitting blocks at EGPRS level change from EGPRS2-A to EGPRS.	

### 10.4.9 TLLI Indicator (TI) bit

The TLLI Indicator (TI) bit indicates the presence of an optional TLLI/G-RNTI field within the RLC data block.

**Table 10.4.9.1: TLLI Indicator (TI) bit**

bit 1	TLLI indicator (TI) bit
0	TLLI/G-RNTI field is not present
1	TLLI/G-RNTI field is present

### 10.4.9a Address Control (AC) bit

The Address Control (AC) bit is used to indicate the presence of the optional TFI/D octet in the header of downlink RLC/MAC control blocks.

**Table 10.4.9a.1: Address Control (AC) bit**

bit 1	Address Control (AC) bit
0	TFI/D octet is not present
1	TFI/D octet is present

### 10.4.9b Final Segment (FS) bit

The Final Segment (FS) bit indicates that the downlink RLC/MAC control block contains the final segment of an RLC/MAC control message except when it is sent using extended RLC/MAC control message segmentation. In case of extended RLC/MAC control message segmentation, the final segment of an RLC/MAC control message is indicated with the FSe bit as defined in sub-clause 10.4.9e while the FS bit is set to "0" (see sub-clauses 9.1.12a and 10.4.12b).

**Table 10.4.9b.1: Final Segment (FS) bit**

bit 2	Final Segment (FS) bit
0	Current block does not contain the final segment of an RLC/MAC control message
1	Current block contains the final segment of an RLC/MAC control message

### 10.4.9c Radio Transaction Identifier (RTI) field

The Radio Transaction Identifier (RTI) field is used to group the downlink RLC/MAC control blocks that make up an RLC/MAC control message and identifies the segmented control message sequence with which the downlink RLC/MAC control block is associated. The RTI field is five bits in length with range 0 to 31.

### 10.4.9d Direction (D) bit

The Direction (D) bit indicates the direction of the TBF identified by the TFI field in the downlink RLC/MAC control block header.

**Table 10.4.9d.1: Direction (D) bit**

bit 1	Direction (D) bit
0	TFI field identifies an uplink TBF
1	TFI field identifies a downlink TBF

### 10.4.9e Final Segment extension (FSe) bit

The Final Segment extension (FSe) bit indicates that the downlink RLC/MAC control block contains the final segment of an RLC/MAC control message segmented using extended RLC/MAC control message segmentation (see sub-clauses 9.1.12a and 10.4.12b). The FSe bit is only present from the second RLC/MAC control block onwards.

**Table 10.4.9e.1: Final Segment extension (FSe) bit**

bit 5	Final Segment extension (FSe) bit
0	Current block does not contain the final segment of an RLC/MAC control message
1	Current block contains the final segment of an RLC/MAC control message

## 10.4.10 Temporary Flow Identity (TFI) field

In the header of an RLC/MAC block for data transfer, the TFI identifies the Temporary Block Flow (TBF) to which the RLC data block belongs. For the downlink and the uplink TFI the TFI field is 5 bits in length and are encoded as a binary number with range 0 to 31. When eTFI is assigned it is 3 bits in length and is encoded as a binary number with range 0 to 7. TFI and eTFI (if assigned) together identify the downlink Temporary Block Flow (TBF). In downlink RLC/MAC control blocks, the TFI identifies the Temporary Block Flow (TBF) to which the RLC/MAC control message contained in the downlink RLC/MAC control block relates. If present, this field indicates the mobile station to which the control message is addressed; all other mobile stations shall analyse the distribution contents, depending on their protocol state, as specified in clauses 5 and 7 of the present document, except if the downlink RLC/MAC control block is sent using an eTFI in which case only the mobile station to which the control message is addressed shall analyse the content. If this field is present and the contents of the control message also contain a TFI addressing the mobile station, the mobile station shall ignore the TFI in the control message contents. If this field is not present all mobile stations shall interpret the contents of the control message, except if the downlink RLC/MAC control block is sent using an eTFI in which case only the mobile stations that support that eTFI shall interpret the contents of the control message.

If a valid TFI field or valid TFI-eTFI fields (see sub-clause 10.3a.5) are included in a PAN field, they identify the Temporary Block Flow (TBF) being acknowledged.

### 10.4.10a Power Reduction (PR) field

The Power Reduction (PR) field indicates the power level reduction of the current RLC block.

The coding of Power Reduction (PR) field is shown in Table 10.4.10a.1. There is one value of the PR field which indicates that the field shall be ignored by the MS.

If downlink power control is not used, the MS shall ignore the PR field.

If downlink power control is used and the PR field is not included in a downlink RLC/MAC control block, the MS shall act as if the block contained a usable PR field with value "0 0".

**Table 10.4.10a.1: Power Reduction (PR) field**

bit 8 7	Power Reduction
0 0	0 dB (included) to 3 dB (excluded) less than BCCH level - P0
0 1	3 dB (included) to 7 dB (excluded) less than BCCH level - P0
1 0	7 dB (included) to 10 dB (included) less than BCCH level - P0
1 1	Not usable

### 10.4.11 Extension (E) Bit

The Extension (E) bit is used to indicate the presence of an optional octet in the RLC data block header.

**Table 10.4.11.1: Extension (E) bit**

bit 1	E bit
0	Extension octet follows immediately
1	No extension octet follows

In *A/Gb mode*, extension (E) bit after the PFI field is used for extensions of the protocol by allowing optional octets in the RLC data block header. However, when extensions of this protocol are developed, networks will treat all unknown optional octets as spare until the E bit of 1.

## 10.4.12 Block Sequence Number (BSN) field

The Block Sequence Number (BSN) field carries the sequence absolute Block Sequence Number (BSN') modulo Sequence Number Space (SNS) (128 in GPRS, 2 048 in EGPRS and 8192 in a DLMC configuration) of each RLC data block within the TBF.

In GPRS, the BSN is 7 bits in length and is encoded as a binary number with range 0 to 127.

In EGPRS, or in a DLMC configuration where a SNS of 2048 is used (see sub-clause 5.13), the BSN is 11 bits in length and is encoded as a binary number with range 0 to 2 047.

In a DLMC configuration where a SNS of 8192 is used (see sub-clause 5.13), the BSN is 13 bits in length and is encoded as a binary number with range 0 to 8191.

In case two to four RLC data blocks are sent within a RLC/MAC block, BSN2 to BSN4 are relative to BSN1, provided the difference between the second to fourth block number and the first block modulo SNS is less than Window Size (WS).

For example,

Second block number =  $[BSN1 + BSN2]$  modulo SNS

(e.g. SNS = 2 048, WS = 512, Block A block number = 10 and Block B block number = 2 000 then:

$[Block A - Block B]$  modulo SNS = 58 < 512;

$[Block B - Block A]$  modulo SNS = 1 990 > 512;

Then: Block #1 = Block B and Block #2 = Block A, BSN1 = 2 000 and BSN2 = 58).

In a DLMC configuration there are restrictions regarding the selection of RLC data blocks for inclusion within a given RLC/MAC block:

- In the RLC/MAC header for MCS-7, MCS-8 and MCS-9 13 bits for BSN1 and 11 bits for BSN2 are defined. For these MCSs the difference between the two RLC data blocks (Block A and Block B) shall be less than 2048.
  - i.e.  $[Block A - Block B]$  modulo SNS < 2048 or  $[Block B - Block A]$  modulo SNS < 2048
- In the RLC/MAC header for DAS-11 and DAS-12 13 bits for BSN1, 12 bits for BSN2 and 11 bits for BSN3 are defined. For these MCSs the difference between two of the RLC data blocks (i.e. two out of Block A, B or C) shall be less than 2048.
  - i.e.  $[Block X - Block Y]$  modulo SNS < 2048 or  $[Block Y - Block X]$  modulo SNS < 2048 where X is any one of Block A, B or C, and Y is any of the two remaining blocks.

For example,

SNS = 8192, WS = 4096:

BSN1=2000 (Block B block number=2000)

BSN2=58 (Block A block number=2058)

- $[Block A - Block B]$  modulo 8192 = 58 < 4096
- $[Block B - Block A]$  modulo 8192 = 8133 > 4096

then Block C block number shall fulfill  $[Block C - Block B]$  modulo SNS < 2048.

For example Block C block number = 4003, and BSN3=2003

- $[Block C - Block B]$  modulo 8192 = 2003 < 2048

### 10.4.12a Reduced Block Sequence Number (RBSN) bit

The Reduced Block Sequence Number (RBSN) bit carries the sequence number of the downlink RLC/MAC control blocks. The RBSN bit is encoded as a binary number with range 0 to 1.

### 10.4.12b Reduced Block Sequence Number extension (RBSNe) field

The Reduced Block Sequence Number extension (RBSNe) field together with the RBSN bit indicate the sequence number of the downlink RLC/MAC control blocks of an RLC/MAC control message segmented using extended RLC/MAC control message segmentation. The RBSNe field is encoded as a binary number with range 0 to 7. Along with the FS bit and the FSe bit, they allow for extended RLC/MAC control message segmentation as shown in table 10.4.12b.1 (see sub-clause 9.1.12a).

**Table 10.4.12b.1: RBSN bit, FS bit, RBSNe field, FSe bit**

RBSN	FS	RBSNe	FSe	
0	0	N/A	N/A	1 <sup>st</sup> RLC/MAC control block
1	0	0 0 0	0	2 <sup>nd</sup> RLC/MAC control block
1	0	0 0 1	0 / 1	3 <sup>rd</sup> / last RLC/MAC control block
1	0	0 1 0	0 / 1	4 <sup>th</sup> / last RLC/MAC control block
1	0	0 1 1	0 / 1	5 <sup>th</sup> / last RLC/MAC control block
1	0	1 0 0	0 / 1	6 <sup>th</sup> / last RLC/MAC control block
1	0	1 0 1	0 / 1	7 <sup>th</sup> / last RLC/MAC control block
1	0	1 1 0	0 / 1	8 <sup>th</sup> / last RLC/MAC control block
1	0	1 1 1	1	9 <sup>th</sup> and last RLC/MAC control block

### 10.4.13 More (M) bit

In GPRS TBF mode, the M bit, along with the E bit and the Length Indicator (LI), are used to delimit LLC PDUs within a TBF. When the M bit is present it indicates whether or not another LLC PDU follows the current one within the RLC data block. The function of the M and E bits when they occur in the same octet is defined in table 10.4.13.1.

In EGPRS TBF mode the M bit is not used, instead a special combination of the LI field is used to indicate presence of following LLC PDUs.

**Table 10.4.13.1: M bit and E bit**

bit M E	
0 0	In <i>lu mode</i> , the RLC data block belongs to the signalling radio bearer identified by SRBid (see 3GPP TS 44.160). In A/Gb mode, if received by the mobile station it shall ignore all fields of the RLC/MAC block except for the fields of the MAC header
0 1	no LLC data after the current LLC PDU, no more extension octets
1 0	a new LLC PDU starts after the current LLC PDU and there is another extension octet, which delimits the new LLC PDU
1 1	a new LLC PDU starts after the current LLC PDU and continues until the end of the RLC information field, no more extension octets

### 10.4.14 Length Indicator (LI) field in GPRS TBF mode and DCCH TBF mode (*lu mode*)

The Length Indicator is used to delimit Upper Layer PDUs within the RLC data block. Additionally for *lu mode*, a Length Indicator of value 63 may be used to indicate the presence of filler information within the RLC data block. If the first length indicator in the RLC data block is set to 63, then the entire RLC data block contains filler information.

A Length Indicator of value 62 is used by a mobile station supporting network sharing to indicate the presence of a *Selected PLMN Index* field (see sub-clause 10.4.27) in the octet immediately following this Length Indicator. In this case, it shall always be the first Length Indicator in the RLC data block.



The first Length Indicator (respectively, second length Indicator, if the first is of value 62, as described above) shall indicate the number of octets of the RLC data field belonging to the first Upper Layer PDU, the second Length Indicator (respectively third Length Indicator, if the first is of value 62, as described above) shall indicate the number of octets of the RLC data field belonging to the second Upper Layer PDU, etc. Only the last segment of any Upper Layer PDU of a TBF (either this segment carries the entire Upper Layer PDU or not) shall be identified with a Length Indicator within the corresponding RLC data block.

A singular case occurs when the end of the Upper Layer PDU would fit within the RLC data block but the addition of the corresponding Length Indicator octet (to indicate the Upper Layer PDU boundary) causes the Upper Layer PDU to extend into the next RLC data block. In this case, this additional LI field shall take the value 0 whatever is the length of the last but one Upper Layer PDU segment. The inclusion of a Length Indicator that indicates the presence of a Selected PLMN Index field will never correspond to an Upper Layer PDU and therefore will never result in this singular case.

The final RLC data block of a TBF shall have a Length Indicator field corresponding to the final Upper Layer PDU unless this PDU fills the RLC data block precisely without the LI field being added (i.e. the singular case mentioned above never applies in this situation).

The LI field is 6 bits in length and shall be encoded as a binary number with range 1 to 19, 29, 35 or 49, according to the coding scheme in use, i.e. CS-1, CS-2, CS-3 or CS-4 respectively. The value 0 shall indicate that no Upper Layer PDU boundary exists. In this case the M bit shall be set to '0' and the E bit shall be set to '1' on the transmitting side, while on the receiving side the M bit shall be ignored and the E bit shall be interpreted as having the value '1'. The value 62 may also be used as described above. In *lu mode*, a value of 63 shall indicate the presence of filler information within the RLC data block. All other values are reserved, and in this version of the protocol, the mobile station shall ignore all fields of the RLC data block except for the USF field.

#### 10.4.14a Length Indicator (LI) field in EGPRS TBF mode and TCH TBF mode (*lu mode*)

The Length indicator is used to delimit Upper Layer PDUs within the RLC data block. Additionally for *lu mode*, a Length Indicator of value 127 may be used to indicate the presence of filler information within the RLC data block. If the first length indicator in the RLC data block is set to 127, then the entire RLC data block contains filler information.

The first Length Indicator (respectively, second length Indicator, if the first is of value 123, as described below) shall indicate the number of octets of the RLC data field belonging to the first Upper Layer PDU, the second Length Indicator (respectively third Length Indicator, if the first is of value 123, as described below) shall indicate the number of octets of the RLC data field belonging to the second Upper Layer PDU, etc. Only the last segment of any Upper Layer PDU, including those with only one segment, shall be identified with a Length Indicator. The length indicator shall be placed in the RLC data block corresponding to the last segment of the Upper Layer PDU, unless the Upper Layer PDU without the corresponding LI field fills the RLC data block precisely. In this singular case, the Length Indicator shall be placed as the first Length Indicator in the next in sequence RLC data block and take the value 0. The inclusion of a Length Indicator that indicates the presence of a Selected PLMN Index field (see sub-clause 10.4.27) will never correspond to an Upper Layer PDU and therefore will never result in this singular case.

If the Upper Layer PDU does not fill the current RLC data block, a Length Indicator with value 127 (111 1111) shall be included as the last Length Indicator of the current RLC data block, indicating that there is no following Upper Layer PDU in this RLC data block. If the Upper Layer PDU does not fill the RLC data block and there is only one octet left, then the Length Indicator corresponding to the Upper Layer PDU is the last Length Indicator field that shall be included in the RLC data block.

During RLC non-persistent mode of operation, or, during RLC unacknowledged mode of operation if the network has commanded the usage of "Indication of Upper Layer PDU Start for RLC UM" for the TBF, and if the current RLC data block starts with the first segment of a new Upper Layer PDU, then a Length Indicator taking the value 126 shall be placed as the first Length Indicator in the RLC data block unless a Length Indicator with the value 0, signalling that the last segment of the previous Upper Layer PDU precisely fills the previous in sequence RLC data block, shall be included.

If the network and the mobile station support dynamic timeslot reduction (see sub-clause 8.1.8), a Length Indicator with value 125 indicates the presence of dynamic timeslot reduction control information which shall be included after the last Upper Layer PDU.

If EMSR is enabled, the transmission of an Upper Layer PDU can be suspended to transmit a higher priority Upper Layer PDU by including an LI with a value of 124 as the first LI field within the next transmitted RLC data block where

an octet containing the TFI value associated with the higher priority Upper Layer PDU immediately follows the LI field. The transmission of the suspended Upper Layer PDU is resumed by including an LI with a value of 124 followed by an octet containing the TFI (and eTFI if assigned, see sub-clause 5.13) associated with the Upper Layer PDU whose transmission is resumed after the LI associated with the last segment of the higher priority Upper Layer PDU whose transmission is completed. The transition from the last segment of an Upper Layer PDU to the first segment of a new Upper Layer PDU associated with a different PFC can also occur within an RLC data block (i.e. no suspend occurs) in which case the transition is indicated by including an LI with a value of 124 followed by an octet containing the TFI (and eTFI if assigned) associated with the new Upper Layer PDU after the LI associated with the last segment of the Upper Layer PDU whose transmission is completed. In addition:

- If the last segment of the Upper Layer PDU without the corresponding LI field fills the RLC data block precisely and the next in sequence RLC data block is in the same radio block, then a Length Indicator with the value 0 shall be placed as the first Length Indicator in the next in sequence RLC data block.
- If the last segment of the Upper Layer PDU without the corresponding LI field fills the RLC data block precisely and the next in sequence RLC data block is in a different radio block, then a Length Indicator with the value 0 shall be placed as the first Length Indicator in the next in sequence RLC data block and the TFI in the RLC/MAC header associated with the next in sequence RLC data block and, if eTFI is assigned, the eTFI indicated by the CRC of the next in sequence RLC data block, shall correspond to the last segment of the Upper Layer PDU.
- When a Length Indicator having the value 124 is included in the same RLC data block as the last segment of the Upper Layer PDU and fills the RLC data block precisely then the first octet of the RLC data field of the next in sequence RLC data block shall include the TFI (and eTFI if assigned) corresponding to the Upper Layer PDU whose transmission is resumed (if a suspend occurred) or to a new Upper Layer PDU (if no suspend occurred).

A Length Indicator of value 123 is used by a mobile station supporting network sharing to indicate the presence of the *Selected PLMN Index* field (see sub-clause 10.4.27) in the octet immediately following this Length Indicator. In this case it shall always be the first Length Indicator in the RLC data block. The first Length Indicator used for the case of EMSR requires that at least one previous RLC data block has been sent for the uplink TBF whereas the first Length Indicator used to indicate the presence of the Selected PLMN Index field shall always occur within the very first RLC data block sent for the uplink TBF and as such they can never occur within the same RLC data block.

The final RLC data block of a TBF shall have a Length Indicator field corresponding to the final Upper Layer PDU unless the final Upper Layer PDU fills the RLC data block precisely. If the final Upper Layer PDU fills the final RLC data block precisely, the final Upper Layer PDU shall be sent without a corresponding Length Indicator field.

The Length Indicator field is 7 bits in length and shall be encoded as a binary number. The valid values are the values ranging from 0 to 74 for an EGPRS TBF, an EGPRS2-A uplink TBF or an EGPRS2-B TBF, from 0 to 82 for an EGPRS2-A downlink TBF, from 0 to 103 in TCH TBF mode (*Iu mode*), and the values 124 to 127. All other values are reserved. A mobile station detecting a reserved Length Indicator value or an inconsistent encoding of the Length Indicator and E fields shall ignore the RLC data block.

The interpretation of the value contained in the length indicator with corresponding E bit is summarized in table 10.4.14a.1 and some examples are shown in annex B.

Table 10.4.14a.1: Interpretation of values of LI field and E bit

Value of LI in a RLC data block	Value of E bit in the same octet	Interpretation
k-th LI (k>0 integer): 0< value <75 (EGPRS except EGPRS2-A downlink) 0< value <83 (EGPRS2-A downlink) 0< value <104 (TCH)	0	The value of the k-th LI is the number of octets of the k-th Upper Layer PDU, or the last segment of it, in the current RLC data block.
	1	There is at least one Upper Layer PDU following the k-th Upper Layer PDU in the current RLC data block.
	1	There is no more than one Upper Layer PDU following the k-th Upper Layer PDU in the current RLC data block.
1 <sup>st</sup> LI: value =0	0	The last Upper Layer PDU of the previous in sequence RLC data block ends at the boundary of that RLC data block and it has no LI in the header of that RLC data block. Thus the current RLC data block contains the first segment of all included Upper Layer PDUs.
1 <sup>st</sup> LI: value = 126	0	The current RLC data block contains the first segment of all included Upper Layer PDUs.
k-th LI (k>1 integer): 0< value <75 (EGPRS except EGPRS2-A downlink) 0< value <83 (EGPRS2-A downlink) 0< value <104 (TCH)	0	The k-th LI contains the number of octets of the (k-1)-th Upper Layer PDU in the current RLC data block.
	0	There is at least one Upper Layer PDU following the (k-1)-th Upper Layer PDU in the current RLC data block.
	1	There is no more than one Upper Layer PDU following the (k-1)-th Upper Layer PDU in the current RLC data block.
k-th LI: value=127	1	The octets between the end of the Upper Layer PDU indicated by the (k-1)-th LI and the end of the current RLC data block are filling octets.
1 <sup>st</sup> LI: value=0	1	The previous RLC data block contains a Upper Layer PDU, or a part of it, that fills precisely the previous data block and for which there is no length indicator in that RLC data block. The current RLC data block contains a Upper Layer PDU that either fills the current RLC data block precisely or continues in the next RLC data block.
1 <sup>st</sup> LI: value = 126	1	The current RLC data block contains the first segment of an Upper Layer PDU that either fills the current RLC data block precisely or continues in the next RLC data block.
1 <sup>st</sup> LI: value=127 ( <i>lu mode only</i> )	1	All octets of the RLC Data block contain filling information.
k-th LI: value=125	0/1	The current RLC data block contains the dynamic timeslot reduction control information.
k-th LI: value=124 (this value is only allowed if EMSR is enabled)	0	An LI value of 124 serves as a TFI transition indicator and is immediately followed by an octet containing the TFI associated with the next Upper Layer PDU segment in bit positions 1 to 5 (where bit 5 is the most significant bit) and reserved bits in bit positions 6 to 8. If eTFI is assigned then it shall be indicated by bit positions 6 to 8 (where bit 8 is the most significant bit).
1 <sup>st</sup> LI: value=123 (this value is only allowed if network sharing is supported both by the network and the mobile station)	0/1	An LI value of 123 serves as a <i>Selected PLMN Index</i> field indicator and is immediately followed by an octet that contains the <i>Selected PLMN Index</i> field (see sub-clause 10.4.27).
No LI field present	n.a.	The Upper Layer PDU that starts with the current RLC data block either fills the current RLC data block precisely or continues in the following in-sequence RLC data block

## 10.4.15 TLLI field

The TLLI field contains a TLLI encoded as the contents of the TLLI information element defined in 3GPP TS 44.018.

## 10.4.16 RLC data field

The RLC data field contains octets from one or more Upper Layer PDUs. The RLC data field may contain parts of one or two Upper Layer PDUs and all of an arbitrary number of Upper Layer PDUs. The E bit, the M bit, and the Length Indicator delimit the RLC data field into Upper Layer PDUs. If the last Upper Layer PDU of a downlink TBF or an uplink RLC data block with CV = 0 does not fill the entire RLC data field, an extension octet shall be used to indicate the number of valid RLC data octets. The remainder of the RLC data field shall be filled with filler octets with the value '00101011'. Only the last RLC data block of a downlink TBF or an uplink RLC data block with CV = 0 may contain filler octets. If an uplink TBF is continued after the RLC data block with CV = 0, the next Upper Layer PDU starts with the first octet of the RLC data field of the next in sequence RLC data block.

## 10.4.17 Control message contents field

The Control message contents field shall contain exactly one segment from one RLC/MAC control message field (i.e. RLC/MAC control block).

## 10.4.18 Resent Block Bit (RSB)

The Resent Block Bit (RSB) indicates whether any of the RLC data blocks contained within the EGPRS radio block have been sent previously. The setting of this field is shown in table 10.4.18.1.

**Table 10.4.18.1: Resent block bit**

bit	
0	All of the RLC data blocks contained within the EGPRS radio block are being transmitted for the first time
1	At least one RLC data block contained within the EGPRS radio block has been transmitted before
NOTE:	The use of this bit shall be reconsidered in future versions of the present document.

## 10.4.19 PFI Indicator (PI) bit

The PFI Indicator (PI) indicates the presence of the optional PFI field. The PI shall be ignored in *Iu mode*.

**Table 10.4.19.1: PFI Indicator (PI) bit**

bit	PFI Indicator (PI) bit
0	PFI is not present
1	PFI is present if TI field indicates presence of TLLI

## 10.4.20 Packet Flow Identifier (PFI) field

The PFI field contains a PFI value encoded as the contents of the PFI information element as defined in 3GPP TS 44.018.

## 10.4.21 PAN Indication (PANI) field

The PANI field indicates the presence of the PAN field.

**Table 10.4.21.1: PAN Indication (PANI) field**

bit	PANI
0	A PAN field is not included
1	A PAN field is included

## 10.4.22 Beginning of Window (BOW) field

The BOW (begin of window) bit shall be set if  $SSN = [V(Q) + 1]$  modulo SNS.

## 10.4.23 Short Starting Sequence Number (ShortSSN) field

The ShortSSN field contains the  $L$  least significant bits of an SSN. The size  $L$  of the ShortSSN field is determined from the window size as follows:

$$\text{ShortSSN size} = \lceil \log_2(WS) \rceil + 1$$

In RLC non-persistent mode, if the assigned window size is less than 64 the size of the ShortSSN field is 7 bits.

## 10.4.24 Carrier ID (CI) field

The CI field contains a carrier ID and shall be encoded as CI\_DTR IE as defined in sub-clause 11.2.28. It indicates the carrier the mobile station shall monitor when DTR is used (see sub-clause 8.1.8). The timeslot or PDCH-pair to monitor on this carrier is indicated with the TN/PDCH-pair field.

When DTR is used in a DLMC configuration the mobile station shall ignore this field (see sub-clause 8.1.8.2).

## 10.4.25 TN/PDCH-pair field

This field contains the timeslot number (BTTI configuration) or the PDCH-pair number (RTTI configuration) the mobile station shall monitor on the indicated carrier (CI field) when DTR is used (see sub-clause 8.1.8).

## 10.4.26 DTR Blks

This field indicates the subset of downlink radio blocks the mobile station shall monitor for USFs and/or downlink RLC data blocks in DTR mode. The field is coded as in table 10.4.26.1, where the block numbers are specified in 3GPP TS 45.002.

**Table 10.4.26.1: Radio blocks monitored in DTR mode**

DTR Blks bit 6 5	BTTI Configuration	RTTI Configuration	
		BTTI USF mode	RTTI USF mode
0 0	All	All	All
0 1	B0, B2, B4, B6, B8, B10	B0 <sub>a</sub> , B0 <sub>b</sub> , B2 <sub>a</sub> , B2 <sub>b</sub> , B4 <sub>a</sub> , B4 <sub>b</sub> , B6 <sub>a</sub> , B6 <sub>b</sub> , B8 <sub>a</sub> , B8 <sub>b</sub> , B10 <sub>a</sub> , B10 <sub>b</sub>	B0 <sub>a</sub> , B1 <sub>a</sub> , B2 <sub>a</sub> , B3 <sub>a</sub> , B4 <sub>a</sub> , B5 <sub>a</sub> , B6 <sub>a</sub> , B7 <sub>a</sub> , B8 <sub>a</sub> , B9 <sub>a</sub> , B10 <sub>a</sub> , B11 <sub>a</sub>
1 0	B0, B4, B8	B0 <sub>a</sub> , B0 <sub>b</sub> , B4 <sub>a</sub> , B4 <sub>b</sub> , B8 <sub>a</sub> , B8 <sub>b</sub>	B0 <sub>a</sub> , B2 <sub>a</sub> , B4 <sub>a</sub> , B6 <sub>a</sub> , B8 <sub>a</sub> , B10 <sub>a</sub>
1 1 (NOTE)	reserved	reserved	reserved
NOTE: When received it shall be interpreted as '00'.			

## 10.4.27 Selected PLMN Index field

This field contains the index of the PLMN selected by a mobile station supporting network sharing. The index value refers either to the identity of the Common PLMN broadcast in the SYSTEM INFORMATION TYPE 3/4 message or to the identity of an Additional PLMN broadcast in the SYSTEM INFORMATION TYPE 22 message, as described in Table 10.4.27.1.

Table 10.4.27.1: Selected PLMN Index field

bit 3 2 1	Selected PLMN Index
0 0 1	PLMN identity of the Common PLMN broadcast in SYSTEM INFORMATION TYPE 3/4
0 1 0	PLMN identity of the first Additional PLMN in the network sharing information broadcast in SYSTEM INFORMATION TYPE 22
0 1 1	PLMN identity of the second Additional PLMN in the network sharing information broadcast broadcast in SYSTEM INFORMATION TYPE 22
1 0 0	PLMN identity of the third Additional PLMN in the network sharing information broadcast in SYSTEM INFORMATION TYPE 22
1 0 1	PLMN identity of the fourth Additional PLMN in the network sharing information broadcast in SYSTEM INFORMATION TYPE 22
	All other values are reserved

## 11 Message functional definitions and contents

This sub-clause defines the structure of the RLC/MAC control messages. These are non-standard L3 messages as defined in 3GPP TS 24.007. The formats for the messages are valid only for the PDCH. The format for RLC/MAC control messages for use on the CCCH are defined in 3GPP TS 44.018.

The RLC/MAC control messages defined in this sub-clause may be used also on DBPSCH and SBPSCH in *Iu mode* according to the requirements specified in 3GPP TS 44.160. A subset of these messages is used exclusively in *Iu mode*. Messages belonging to that subset are labelled as "*Iu mode only*" in this technical specification.

A subset of the *Iu mode only* messages is used exclusively on DBPSCH. These messages do not follow the general syntactical rules for the RLC/MAC control messages used on shared channels. The error handling defined for shared channels does not apply. Messages that may be sent from the network to the mobile station, and that belong to this subset, are classified as *DBPSCH messages*, see sub-clause 11.1.1.

Each definition given in the present sub-clause includes:

- a brief description of the message direction and use;
- a CSN.1 description of the message information elements and fields (see CSN.1 Specification, Version 2.0). Definition of information elements may immediately follow the definition of the message. If the definition of an information element immediately follows the message definition, the information element name ends with 'struct'. Otherwise the information element name ends with 'IE' and the definition of the information element is defined in clause 12 or in 3GPP TS 44.018. The definition of a 'struct' is valid only within the table in which it is defined. No references shall be made to a 'struct' definition from outside of the table in which it is defined or from outside the present document. The definition of an information element is valid throughout clause 11 and clause 12 as well as in 3GPP TS 44.018;
- a note specifying, where appropriate, conditions for information elements or fields with presence requirement C or O in the relevant message which together with other conditions specified in 3GPP TS 44.060 define when the information elements shall be included or not, what non-presence of such information elements or fields means, and - for IEs with presence requirement C - the static conditions for presence and/or non-presence of the information elements or fields (see 3GPP TS 24.007);
- a table follows which contains a definition for each field referenced in the message definition or in an information element struct immediately following the message definition.

Bit fields within RLC/MAC messages shall have the highest numbered bit of the bit field in the highest numbered bit of the lowest number octet (see sub-clause 10.0b.3.1). The mapping of an 11 bit field is illustrated in figure 11.1.

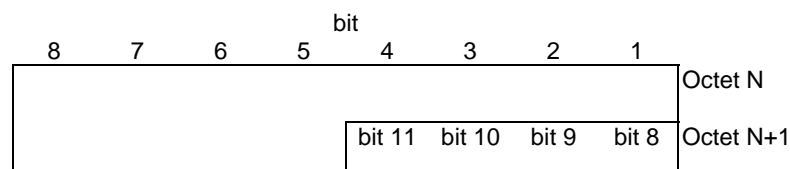

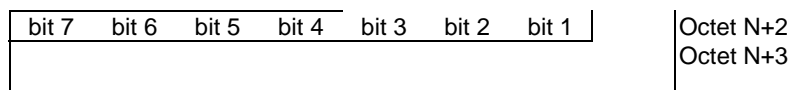

**Figure 11.1: Field mapping within RLC/MAC messages**

The length of an RLC/MAC control messages is an integer number of RLC/MAC control blocks. Padding bits are necessary to fill the message up to the desired length. The padding bits may be the 'null' string. Otherwise, the padding bits starts with bit '0', followed by 'spare padding'.

```
< padding bits > ::= { null | 0 < spare padding > | < ignore : 1 bit** = < no string > } ;
```

The padding sequence used for 'spare padding' in the present document, see 3GPP TS 24.007, is a repetition of octet '00101011', starting on an octet boundary.

## 11.1 Handling of erroneous protocol data

This sub-clause specifies procedures for the handling of unknown and erroneous protocol data by the receiving entity.

These error-handling procedures are mandatory for the mobile station.

A message is defined to be syntactically incorrect if it violates rules of clauses 11 and 12, or if it contains at least one value defined as "reserved" in clauses 11 and 12. However, if the rules of clause 11 and 12 define a specific interpretation for a "reserved" value, the specified interpretation takes precedence and the considered field remains syntactically correct.

Decoding a received message based on its CSN.1 description yields the complete acceptance or rejection of the message. Error handling allows a message to be partially accepted even when some parts are erroneous.

Error detection mechanisms are introduced to identify which parts of a message to be protected against which kinds of errors.

### 11.1.1 Message classification

The packet data channel (PDCH) is a shared resource, i.e. all mobile stations assigned resources on a PDCH may receive a message sent by the network. The message type is identified by the MESSAGE\_TYPE field contained in each message. The message type is used for classification and determining the message syntax.

Messages sent from the network to the mobile station on PDCH (*A/Gb mode* and *Iu mode*) or DBPSCH (*Iu mode*) are classified as either distribution messages or non-distribution messages.

Messages sent from the network to the mobile station exclusively on DBPSCH (*Iu mode*) are classified as DBPSCH messages.

#### 11.1.1.1 Distribution messages

A distribution message is recognised by the most significant bit of the message type being set to bit '1'. The general format of a distribution message sent from the network to the mobile station is:

```
< Distribution message > ::=
  < MESSAGE_TYPE : 1 bit (5) >
  < Distribution contents >
  < padding bits > ;
```

Any mobile stations may receive a distribution message. Depending on the protocol state of the mobile station, a distribution message shall be analysed as specified in sub-clauses 5, 6, 7, 8 and 9 of the present document.

The 'Distribution contents' of a distribution message contains Page Mode information and any specific specific distribution information according to the syntax defined for the message type. The 'padding bits' of a distribution message can be reduced to the null string.

The general format of the 'Distribution contents' is:

```
< Distribution contents > ::=
  < PAGE_MODE : bit (2) >
  < specific distribution information > ;
```

The encoding of the Page Mode information is defined in sub-clause 12.20.

### 11.1.1.2 Non-distribution messages

A non-distribution message is recognised by the most significant bit of the message type being set to bit '0'. The general format of a message sent from the network to the mobile station is:

```
< Non-distribution message > ::=
  < MESSAGE_TYPE : 0 bit (5) >
  < Distribution contents >
  < Address information > < Non-distribution contents >
  < padding bits > ;
```

Any mobile station may receive a non-distribution message.

The 'Distribution contents' of a non-distribution message contains Page Mode information and any specific distribution information according to the syntax defined for the message type. The general format of the 'Distribution contents' is defined in sub-clause 11.1.1.1. Depending on the protocol state of the mobile station, the 'Distribution contents' of a non-distribution message shall be analysed as specified in clauses 5 and 7 of the present document.

The 'Address information' contained in a non-distribution message shall be analysed by a mobile station receiving the message. The 'Non-distribution contents' following the address information shall be ignored by any mobile station not identified by the address information. The allowed addressing options and the specific syntax of the 'Non-distribution contents' depend on the message type. The 'padding bits' of a non-distribution message can be reduced to the null string.

#### 11.1.1.2.1 Format of the address information

The general format of the 'Address information' in a non-distribution message is:

```
< Address information > ::=
  0 < Global TFI IE > | -- see sub-clause 12.10
  1 0 < TLLI / G-RNTI > | -- see sub-clause 12.16
  1 1 0 < TQI > | -- see sub-clause 12.17
  1 1 1 < Packet Request Reference IE > ; -- see sub-clause 12.11
```

The description of a certain message type may specify a restricted set of addressing options being syntactically correct in the message. A message received with a disallowed addressing option shall be regarded as syntactically incorrect.

### 11.1.1.3 DBPSCH message (*lu mode* only)

A DBPSCH message is sent exclusively on DBPSCH, from the network to the mobile station, in *lu mode*. The general format of such a message is:

```
< DBPSCH message > ::=
  < DBPSCH message contents >
  < padding bits > ;
```

The 'padding bits' of a DBPSCH message can be reduced to the null string.

The general format of the 'DBPSCH message contents' is:

```
< DBPSCH message contents > ::=
  < MESSAGE_TYPE : bit (6) >
  < specific DBPSCH message information > ;
```



## 11.1.2 Error detection mechanism

The symbol '!' indicates an error branch. It acts as a separator (similar to the '|' choice symbol) where the choice on the right of the '!' are to be considered as an 'error' branch. The symbol '!' allows partial analysis of data in a received message, with some parts of the message to be ignored due to it being syntactically incorrect.

The description on the left of '!' defines the set of syntactically correct data and shall be recognised correctly. Otherwise, the data associated shall be rejected and the description within the error branch shall be used.

The description within the error branch, on the right of '!', shall accept any syntactically incorrect data. Therefore, according to the error label the relevant error handling procedure shall be implemented.

## 11.1.3 Error labels

There are different categories of error labels introduced in clauses 11 and 12 of the present document.

### 11.1.3.1 Generic error labels

Generic error labels are defined for syntactical errors 'Unknown message type', 'Distribution part error', 'Address information part error' and 'Non-distribution part error'.

The general format of a distribution message, including these error labels, is:

```
< Distribution message > ::=
  < MESSAGE_TYPE : 1 bit (5) >
  {
    < Distribution contents >
    < padding bits >
    ! < Distribution part error : bit (*) = < no string > > }
  ! < Unknown message type : bit (6) = < no string > < Default downlink message content > > ;
```

The general format of a non-distribution message, including these error labels, is:

```
< Non-distribution message > ::=
  < MESSAGE_TYPE : 0 bit (5) >
  {
    < Distribution contents >
    {
      < Address information >
      {
        < Non-distribution contents >
        < padding bits >
        ! < Non-distribution part error : bit (*) = < no string > > }
      ! < Address information part error : bit (*) = < no string > > }
    ! < Distribution part error : bit (*) = < no string > > }
  ! < Unknown message type : bit (6) = < no string > < Default downlink message content > > ;
```

The general format of a DBPSCH message, including these error labels, is:

```
< DBPSCH message > ::=
  {
    < DBPSCH message contents >
    < padding bits >
    ! < DBPSCH message part error : bit (*) = < no string > > } ;
```

These error labels allow ignoring a part of the message that is syntactically incorrect. Once an error is detected, the error branch is called. Except for the 'Unknown message type', the error branch is, followed by an unspecified bit string that expands to the end of the message. The corresponding data is ignored. In case of an 'Unknown message type', further treatment of the message is defined in sub-clause 11.1.4.1.

### 11.1.3.2 'Ignore' error label

An 'Ignore' error label is used to ignore part of the message. The generic description is:

```
< content > ! < Ignore : bit (*) = < no string > > -- Ignore by indefinite length
```

Or

< content of fixed length n > ! < Ignore : bit (n) = < no string > > -- *Ignore by definite length*

An 'Ignore' error label shall be applied by the receiver of a downlink RLC/MAC control message when specified in the message description in clauses 11 and 12 of the present document. This error label allows ignoring a part of the message that is syntactically incorrect. Once the error is detected, the error branch 'Ignore' is called followed by a an unspecified bit string.

When this error label is used with an indefinite length (bit (\*) = < no string >), the unspecified bit string expands to the end of the message and the corresponding data is ignored.

NOTE: If this error label is used with the indefinite length within a structure or delimited description (i.e. within { } brackets), any description following the structure or delimited description must allow truncation, in order to be consistent with the CSN.1 description of the message.

When this error label is used with a definite length (bit (n) = < no string >), the unspecified bit string contains a defined number of bits. The corresponding data is ignored.

### 11.1.3.3 'Message escape' error label

The 'Message escape' error label is used to provide an escape for, e.g. a future modification of the message syntax. The generic description is:

0 < Content > ! < Message escape : 1 bit (\*) = < no string > >

An 'Message escape' error label shall be applied by the receiver of a downlink RLC/MAC control message when specified in the message description in clauses 11 and 12 of the present document. The description on the left of the error branch needs to be correctly recognised. Otherwise, the error branch 'Message escape' is called and the remaining part of the message is ignored.

NOTE: Any description following a structure or delimited description (i.e. within { } brackets) including this error label must allow truncation. Otherwise, it is not consistent with the CSN.1 description of the message.

## 11.1.4 Error detection and order of precedence

A mobile station shall detect and process errors in the order in which they are defined in this sub-clause of the present document. (E.g. a message, which is not compatible with the current protocol state AND is syntactically incorrect, shall be treated as if it is not compatible with the current protocol state.)

At certain error events defined in this sub-clause, the PACKET TBF STATUS message shall be sent by the mobile station. In case of multiple error events, and, due to restrictions defined in sub-clauses 5, 6, 7, 8 and 9, the mobile station is not able to send a first status message until the occurrence of a subsequent event generating a second status message, the mobile station shall suppress the sending of the second and additional status messages until the first status message has been sent to the network.

### 11.1.4.1 Unknown message type

If a mobile station receives a message with message type either not defined or not implemented (generic error label: 'Unknown message type'), the content of the bits representing the message type shall be ignored.

The remaining part of the message shall be analysed according to the syntax defined as the 'Default downlink message content' in sub-clause 11.2.0.1. The 'Default downlink message content' contains the Page Mode information. Depending on the protocol state of the mobile station, the Page Mode information shall be analysed as specified in clause 5 of the present document.

#### 11.1.4.2 Message not compatible with current protocol state

When a non-distribution message is received, which is not expected by the addressed receiver in its current protocol state, the mobile station shall follow the procedures that are described in sub-clauses 5, 6, 7, 8 and 9 of the present document.

If no such reaction is specified, the mobile station shall ignore the message. If in packet transfer mode, the mobile station, which is identified by the address information shall return a status message (PACKET MOBILE TBF STATUS message) with TBF\_CAUSE #4, "Message not compatible with current protocol state".

Unexpected distribution messages are ignored.

#### 11.1.4.3 Syntactically incorrect message

When a message containing a syntactically incorrect data is received, depending on the error detection mechanisms that may be defined in the CSN.1 description of the message, the message can be rejected or partially accepted.

NOTE: The order, in which the error labels mentioned in this sub-clause are detected and processed, depends on the nesting of error labels defined by the description of each message type in sub-clause 11.2 and clause 12. E.g. a message, which contains syntactically incorrect data in both the addressing information AND the non-distribution contents, is typically received with the error label 'Address information part error'.

##### 11.1.4.3.1 Messages with error label: 'Distribution part error'

For syntactically incorrect messages received with generic error label: 'Distribution part error', data corresponding to the description following the error label shall be recognised as erroneous data and be ignored.

##### 11.1.4.3.2 Messages with error label: 'Address information part error'

For syntactically incorrect messages received with generic error label: 'Address information part error', data corresponding to the description following the error label shall be recognised as erroneous data and be ignored. The distribution contents preceding the error label may be analysed and treated as described in clause 5 and clause 7 of the present document.

##### 11.1.4.3.3 Messages with error label: 'Non-distribution part error'

For syntactically incorrect messages received with generic error label: 'Non-distribution part error', data corresponding to the description following the error label shall be recognised as erroneous data and be ignored.

The distribution contents preceding the error label may be analysed and treated as described in clause 5 and clause 7 of the present document.

The address information preceding the error label shall be analysed. In packet transfer mode, the mobile station identified by the address information shall return a PACKET MOBILE TBF STATUS message with TBF\_CAUSE #2 "Syntactically incorrect message, non-distribution part error".

##### 11.1.4.3.4 Messages with error label: 'Message escape'

For syntactically incorrect messages with error label: 'Message escape', data corresponding to the description following the error label shall be recognised as erroneously received mandatory data and be rejected.

The distribution contents preceding the error label may be analysed and treated as described in clause 5 of the present document.

If the address information proceeds the error label and it is received correctly, it shall be analysed. In packet transfer mode, the mobile station identified by the address information shall return a PACKET MOBILE TBF STATUS message with TBF\_CAUSE #3 "Syntactically incorrect message, message escape".

#### 11.1.4.3.5 Messages with error label: 'Ignore'

For syntactically incorrect messages with error label: 'Ignore', data corresponding to the description following the error label shall be recognised as unnecessary data. If a syntactically incorrect message with the 'Ignore' error label is received, depending on the length of the unspecified bit string associated with the error label (sub-clause 11.1.3.2), the corresponding data shall be ignored.

#### 11.1.4.3.6 Messages with error label: "DBPSCH message part error"

For syntactically incorrect messages received with generic error label: 'DBPSCH message part error', data corresponding to the description following the error label shall be recognised as erroneous data and be ignored.

#### 11.1.4.4 Syntactic error in truncated concatenation

Truncated concatenation is sequences of components encapsulated by the { } brackets followed by the symbol '//'. The concatenation is any of the concatenations starting with null and up to any number of components.

{ < a > < b > < c > } //
--------------------------

The above set is equivalent to:

{ < a > < b > < c > } or { < a > < b > } or { < a > } or null
--

Any syntactically incorrect component shall truncate the sequence. The correctly received components are accepted and the truncated components are ignored.

NOTE: If the 'padding bits' at the end of a message are included within the concatenation, truncation requires the resulting concatenation to fit exactly with the received message length. Otherwise, it is a syntactical error, which may cause rejection of the complete message or part thereof.

## 11.1.4.5 (void)

## 11.2 RLC/MAC control messages

Table 11.2.1 summarises the RLC/MAC control messages. For each control message, the message type shall be a fixed number of bits from the beginning of the message.

Table 11.2.1: RLC/MAC control messages

<b>Uplink TBF establishment messages:</b>	<b>Reference</b>
Packet Access Reject	11.2.1
Packet Channel Request	11.2.5
EGPRS Packet Channel Request	11.2.5a
Packet Queuing Notification	11.2.15
Packet Resource Request	11.2.16
Packet Uplink Assignment	11.2.29
Multiple TBF Uplink Assignment	11.2.29a
Additional MS Radio Access Capabilities	11.2.32
<b>Downlink TBF establishment messages:</b>	<b>Reference</b>
Packet DBPSCH Assignment	11.2.5b
Packet Downlink Assignment	11.2.7
Multiple TBF Downlink Assignment	11.2.7a
<b>TBF release messages:</b>	<b>Reference</b>
Packet TBF Release	11.2.26
<b>Paging messages:</b>	<b>Reference</b>
Packet Paging Request	11.2.10
<b>RLC messages:</b>	<b>Reference</b>
Packet Downlink Ack/Nack	11.2.6
EGPRS Packet Downlink Ack/Nack	11.2.6a
Packet DBPSCH Downlink Ack/Nack	11.2.6b
Packet DBPSCH Downlink Ack/Nack Type 2	11.2.6c
MBMS Downlink Ack/Nack	11.2.6d
EGPRS Packet Downlink Ack/Nack Type 2	11.2.6e
EGPRS Packet Downlink Ack/Nack Type 3	11.2.6f
Packet Uplink Ack/Nack	11.2.28
Packet DBPSCH Uplink Ack/Nack	11.2.28a
Packet DBPSCH Uplink Ack/Nack Type 2	11.2.28b
EGPRS Packet Downlink Ack/Nack DLMC	11.2.48
<b>System information messages:</b>	<b>Reference</b>
Packet System Information Type 1	11.2.18
Packet System Information Type 2	11.2.19
Packet System Information Type 3	11.2.20
Packet System Information Type 3 bis	11.2.21
Packet System Information Type 3 ter	11.2.21a
Packet System Information Type 3 quater	11.2.21b
Packet System Information Type 5	11.2.23
Packet System Information Type 6	11.2.23a
Packet System Information Type 7	11.2.23b
Packet System Information Type 8	11.2.24
Packet System Information Type 13	11.2.25
Packet System Information Type 14	11.2.25a
Packet System Information Type 15	11.2.25b
Packet System Information Type 16	11.2.25c
<b>Miscellaneous messages:</b>	<b>Reference</b>
Packet Control Acknowledgement	11.2.2
Packet Cell Change Continue	11.2.2a
Packet Cell Change Failure	11.2.3
Packet Cell Change Notification	11.2.3a
Packet Cell Change Order	11.2.4
Packet Downlink Dummy Control Block	11.2.8
Packet Uplink Dummy Control Block	11.2.8b
Packet Measurement Report	11.2.9
Packet Measurement Order	11.2.9b
Packet Mobile TBF Status	11.2.9c
Packet Enhanced Measurement Report	11.2.9d

Packet Neighbour Cell Data	11.2.9e
Packet PDCH Release	11.2.11
Packet Polling Request	11.2.12
Packet Power Control/Timing Advance	11.2.13
Packet PRACH Parameters	11.2.14
Packet PSI Status	11.2.17
Packet Serving Cell Data	11.2.17a
Packet SI Status	11.2.17b
Packet Pause	11.2.30a
Packet Timeslot Reconfigure	11.2.31
Multiple TBF Timeslot Reconfigure	11.2.31a
Handover Access	11.2.33
Physical Information	11.2.34
Packet CS Request	11.2.35
Packet CS Command	11.2.36
Packet CS Release Indication	11.2.37
MBMS Service Request	11.2.38
MBMS Assignment (Non-distribution)	11.2.39
MBMS Assignment (Distribution)	11.2.39a
MBMS Neighbouring Cell Information	11.2.40
MBMS MS_ID Assignment	11.2.41
Packet MBMS Announcement	11.2.42
PS Handover Command	11.2.43
PS Handover Access	11.2.44
Packet Physical Information	11.2.45
DTM Handover Command	11.2.46
Packet Application Information	11.2.47

## 11.2.0 Message format

All RLC/MAC control messages, with the exception of the PACKET CONTROL ACKNOWLEDGEMENT message in access burst format (11-bit and 8-bit contents), the HANDOVER ACCESS message in access burst format (8-bit content), the PS HANDOVER ACCESS message, the PACKET CHANNEL REQUEST message, EGPRS PACKET CHANNEL REQUEST message and MPRACH PACKET CHANNEL REQUEST message, follow the same non-standard format (see 3GPP TS 24.007).

### 11.2.0.1 Downlink RLC/MAC messages

Downlink RLC/MAC control messages are received in RLC/MAC control block format. The different types of messages are distinguished by the MESSAGE\_TYPE field.

```

< Downlink RLC/MAC control message > ::=
  < MESSAGE_TYPE : bit (6) == 1 00001 > < Packet Access Reject message content > |
  < MESSAGE_TYPE : bit (6) == 0 00001 > < Packet Cell Change Order message content > |
  < MESSAGE_TYPE : bit (6) == 0 00010 > < Packet Downlink Assignment message content > |
  < MESSAGE_TYPE : bit (6) == 0 00011 > < Packet Measurement Order message content > |
  < MESSAGE_TYPE : bit (6) == 1 00010 > < Packet Paging Request message content > |
  < MESSAGE_TYPE : bit (6) == 1 00011 > < Packet PDCH Release message content > |
  < MESSAGE_TYPE : bit (6) == 0 00100 > < Packet Polling Request message content > |
  < MESSAGE_TYPE : bit (6) == 0 00101 > < Packet Power Control/Timing Advance message content > |
  < MESSAGE_TYPE : bit (6) == 1 00100 > < Packet PRACH Parameters message content > |
  < MESSAGE_TYPE : bit (6) == 0 00110 > < Packet Queueing Notification message content > |
  < MESSAGE_TYPE : bit (6) == 0 00111 > < Packet Timeslot Reconfigure message content > |
  < MESSAGE_TYPE : bit (6) == 0 01000 > < Packet TBF Release message content > |
  < MESSAGE_TYPE : bit (6) == 0 01001 > < Packet Uplink Ack/Nack message content > | -- PACCH only
  < MESSAGE_TYPE : bit (6) == 0 01010 > < Packet Uplink Assignment message content > |
  < MESSAGE_TYPE : bit (6) == 0 01011 > < Packet Cell Change Continue message content > |
  < MESSAGE_TYPE : bit (6) == 0 01100 > < Packet Neighbour Cell Data message content > |
  < MESSAGE_TYPE : bit (6) == 0 01101 > < Packet Serving Cell Data message content > |
  < MESSAGE_TYPE : bit (6) == 0 01110 > < Packet DBPSCH Assignment message content > |
  < MESSAGE_TYPE : bit (6) == 0 01111 > < Multiple TBF Downlink Assignment message content > |
  < MESSAGE_TYPE : bit (6) == 0 10000 > < Multiple TBF Uplink Assignment message content > |
  < MESSAGE_TYPE : bit (6) == 0 10001 > < Multiple TBF Timeslot Reconfigure message content > |
  < MESSAGE_TYPE : bit (6) == 0 10011 > < MBMS MS_ID Assignment message content > | -- PACCH only
  < MESSAGE_TYPE : bit (6) == 0 10100 > < MBMS Assignment (Non-distribution) message content > |
  < MESSAGE_TYPE : bit (6) == 0 10101 > < PS Handover Command message content > | -- PACCH only
  < MESSAGE_TYPE : bit (6) == 0 10110 > < Packet Physical Information message content > | -- PACCH only
  < MESSAGE_TYPE : bit (6) == 0 10111 > < DTM Handover Command message content > | -- PACCH only
  < MESSAGE_TYPE : bit (6) == 1 00101 > < Packet Downlink Dummy Control Block message content > |
  < MESSAGE_TYPE : bit (6) == 1 10001 > < PSI1 message content > |
  < MESSAGE_TYPE : bit (6) == 1 10010 > < PSI2 message content > |
  < MESSAGE_TYPE : bit (6) == 1 10011 > < PSI3 message content > |
  < MESSAGE_TYPE : bit (6) == 1 10100 > < PSI3 bis message content > |
  < MESSAGE_TYPE : bit (6) == 1 10101 > reserved | -- this value was allocated in an earlier
  -- version of the protocol and shall not be used
  < MESSAGE_TYPE : bit (6) == 1 10110 > < PSI5 message content > |
  < MESSAGE_TYPE : bit (6) == 1 10000 > < PSI6 message content > |
  < MESSAGE_TYPE : bit (6) == 1 11000 > < PSI7 message content > |
  < MESSAGE_TYPE : bit (6) == 1 11001 > < PSI8 message content > |
  < MESSAGE_TYPE : bit (6) == 1 10111 > < PSI13 message content > |
  < MESSAGE_TYPE : bit (6) == 1 11010 > < PSI14 message content > |
  < MESSAGE_TYPE : bit (6) == 1 11100 > < PSI3 ter message content > |
  < MESSAGE_TYPE : bit (6) == 1 11101 > < PSI3 quater message content > |
  < MESSAGE_TYPE : bit (6) == 1 11110 > < PSI15 message content > |
  < MESSAGE_TYPE : bit (6) == 1 01000 > < PSI16 message content > |
  < MESSAGE_TYPE : bit (6) == 1 00000 > < Packet Serving Cell SI message content > |
  < MESSAGE_TYPE : bit (6) == 1 00111 > < Packet CS Command message content > |
  < MESSAGE_TYPE : bit (6) == 1 01001 > < Packet CS Release Indication message content > |
  < MESSAGE_TYPE : bit (6) == 1 01010 > < MBMS Assignment (Distribution) message content > |
  < MESSAGE_TYPE : bit (6) == 1 01011 > < MBMS Neighbouring Cell Information message content > |
  < MESSAGE_TYPE : bit (6) == 1 01100 > < Packet MBMS Announcement message content > |
  < MESSAGE_TYPE : bit (6) == 1 01101 > < Packet Application Information message content > |
  ! < Unknown message type : { bit (6) = < no string > } < Default downlink message content > > ;

```

NOTE: the MESSAGE\_TYPE "010010" is reserved for the PHYSICAL INFORMATION message on DBPSCH only.

The 'Default downlink message contents' consists of the Page Mode information and an unspecified bit string that expands to the end of the message.

```

< Default downlink message content > ::=
  < PAGE_MODE : bit (2) >
  bit (*) = < no string > ;

```

The encoding of the Page Mode information is defined in sub-clause 12.20.

### 11.2.0.2 Uplink RLC/MAC messages

Uplink RLC/MAC control messages, except those using the access burst formats, are received in the RLC/MAC control block format. The different types of messages are distinguished by the MESSAGE\_TYPE field.

```

< Uplink RLC/MAC control message > ::=
  < MESSAGE_TYPE : bit (6) == 000000 > < Packet Cell Change Failure message content > |
  < MESSAGE_TYPE : bit (6) == 000001 > < Packet Control Acknowledgement message content > |
  < MESSAGE_TYPE : bit (6) == 000010 > < Packet Downlink Ack/Nack message content > |-- PACCH only
  < MESSAGE_TYPE : bit (6) == 000011 > < Packet Uplink Dummy Control Block message content > |
  < MESSAGE_TYPE : bit (6) == 000100 > < Packet Measurement Report message content > |
  < MESSAGE_TYPE : bit (6) == 001010 > < Packet Enhanced Measurement Report message content > |
  < MESSAGE_TYPE : bit (6) == 000101 > < Packet Resource Request message content > |
  < MESSAGE_TYPE : bit (6) == 000110 > < Packet Mobile TBF Status message content > |
  < MESSAGE_TYPE : bit (6) == 000111 > < Packet PSI Status message content > |
  < MESSAGE_TYPE : bit (6) == 001000 > < EGPRS Packet Downlink Ack/Nack message content > |
  < MESSAGE_TYPE : bit (6) == 010001 > < EGPRS Packet Downlink Ack/Nack Type 2 message content > |
  < MESSAGE_TYPE : bit (6) == 010010 > < EGPRS Packet Downlink Ack/Nack Type 3 message content > |
  < MESSAGE_TYPE : bit (6) == 001001 > < Packet Pause message content > |
  < MESSAGE_TYPE : bit (6) == 001011 > < Additional MS Radio Access Capabilities message content > |
  < MESSAGE_TYPE : bit (6) == 001100 > < Packet Cell Change Notification message content > |
  < MESSAGE_TYPE : bit (6) == 001101 > < Packet SI Status message content > |
  < MESSAGE_TYPE : bit (6) == 001110 > < Packet CS Request message content > |
  < MESSAGE_TYPE : bit (6) == 001111 > < MBMS Service Request message content > |
  < MESSAGE_TYPE : bit (6) == 010000 > < MBMS Downlink Ack/Nack message content > |
  < MESSAGE_TYPE : bit (6) == 010011 > < EGPRS Packet Downlink Ack/Nack DLMC message content >;

```

Messages using the access burst formats (11-bit and 8-bit formats) are defined in sub-clauses 11.2.2 11.2.5, 11.2.5a, 11.2.5c, 11.2.33 and 11.2.44.

### 11.2.1 Packet Access Reject

This message is sent on the PCCCH or PACCH by the network to the mobile station to indicate that the network has rejected the MSs access request. This message may contain fields addressing more than one mobile station.

Message type: PACKET ACCESS REJECT

Direction: network to mobile station

Classification: distribution message



Table 11.2.1.1: PACKET ACCESS REJECT information elements

```

< Packet Access Reject message content > ::=
  < PAGE_MODE : bit (2) >
  < Reject : < Reject struct > >
  { { 1 < Additional Reject: < Reject struct > > } ** 0
    { null | 0 bit ** = < no string > -- Receiver compatible with earlier releases
      | 1 -- Additions in release 5
        { 1 < lu mode Reject: < lu mode Reject struct > > } ** 0
          { null | 0 bit ** = < no string > -- Receiver compatible with earlier releases
            | 1 -- Additions in release 6
              { 1 < A/Gb mode Reject: < A/Gb mode Reject struct > > } ** 0 }
        }
      } // -- truncation at end of message allowed, bits '0' assumed
  ! < Distribution part error : bit (*) = < no string > > ;

< Reject struct > ::=
  { 0 < TLLI / G-RNTI : bit (32) >
    | 1 { 0 < Packet Request Reference : < Packet Request Reference IE > >
        | 1 < Global TFI : < Global TFI IE > > } }
  { 0 | 1 < WAIT_INDICATION : bit (8) >
    < WAIT_INDICATION_SIZE : bit (1) > }
  ! < Ignore : bit (*) = < no string > > ;

< lu mode Reject struct > ::=
  < G-RNTI_extension : bit (4) >
  { 0 -- all TBF requests for the MS identified by the G-RNTI in the corresponding Reject struct are rejected
    | { 1 < RB Id : bit(5) > } ** 0 } ; -- TBF requests for these RB Ids are rejected

< A/Gb mode Reject struct > ::=
  { 0 -- all TBF requests for the MS identified by the TLLI in the corresponding Reject struct are rejected
    | { 1 < PFI : bit (7) > } ** 0 } ; -- TBF requests for these PFIs are rejected

```

Table 11.2.1.2: PACKET ACCESS REJECT information element details

<p><b>PAGE_MODE</b> (2 bit field) This field is defined in sub-clause 12.20.</p> <p><b>Reject struct</b> The mobile station shall only accept the first Reject struct addressed to it and ignore all other Reject structs.</p> <p><b>Iu mode Reject struct</b> For each occurrence of a G-RNTI in the TLLI / G-RNTI field of a Reject struct, a corresponding <i>Iu mode Reject struct</i> shall be included in the message. The list of <i>Iu mode Reject structs</i> shall address the Iu mode mobile stations in the same order as the list of G-RNTI values in the Reject structs.</p> <p><b>A/Gb mode Reject struct</b> For each occurrence of a TLLI in the TLLI / G-RNTI field of a Reject struct, a corresponding <i>A/Gb mode Reject struct</i> shall be included in the message. The list of <i>A/Gb mode Reject structs</i> shall address the A/Gb mode mobile stations in the same order as the list of TLLI values in the Reject structs.</p> <p><b>Packet Request Reference</b> This information element shall be included if the PACKET ACCESS REJECT message is sent in response to a PACKET CHANNEL REQUEST message. This information element is defined in sub-clause 12.11.</p>
<p><b>TLLI / G-RNTI</b> (32 bit field) This information field shall be included if the PACKET ACCESS REJECT message is sent in response to a PACKET RESOURCE REQUEST message or a Channel Request Description IE contained in a PACKET DOWNLINK ACK/NACK message. This information field is defined in sub-clause 12.16.</p>
<p><b>G-RNTI extension</b> (4 bit field) This field contains the extra 4 bits of the G-RNTI not included in the TLLI / G-RNTI field which are necessary to provide a unique identifier for contention resolution in Iu-mode.</p> <p>For each occurrence of the TLLI / G-RNTI field in the Reject struct, the corresponding G-RNTI extension field shall be included in the Iu mode reject struct in the same order as the list of G-RNTI values in the TLLI / G-RNTI field.</p>
<p><b>Global TFI</b> This information element contains the TFI of one of the mobile station's downlink TBFs or uplink TBFs. This field is defined in sub-clause 12.10.</p>
<p><b>WAIT_INDICATION</b> (8 bit field) The Wait Indication field indicates the time the mobile station shall wait before attempting another channel request. This field is coded as the binary representation of the T3172 timeout value in units of 20 ms or in units of seconds. The units are indicated in the WAIT_INDICATION_SIZE field. Range 0 to 255.</p>
<p><b>WAIT_INDICATION_SIZE</b> (1 bit field) This field indicates the units of the WAIT_INDICATION field.</p> <p>0 the WAIT_INDICATION field is coded in units of s 1 the WAIT_INDICATION field is coded in units of 20 ms</p>
<p><b>RB Id</b> (5 bit field) This field contains the identifier of the radio bearer for which a TBF was requested.</p>
<p><b>PFI</b> (7 bit field) This field contains the PFI parameter identifying a Packet Flow Context. The PFI parameter is encoded as the contents of the PFI information element defined in 3GPP TS 44.018.</p>

## 11.2.2 Packet Control Acknowledgement

This message is sent on the PACCH from the mobile station to the network. In *Iu mode*, it is also sent on FACCH, SACCH and SDCCH from the mobile station to the network. The message is formatted either as an RLC/MAC control block using the PACCH block format defined in 3GPP TS 44.004 or as 4 identical access bursts using the PACCH short acknowledgement block format defined in 3GPP TS 44.004. If the CTRL\_ACK\_EXTENSION field is to be included (i.e. the MS is sending acknowledgement information for a RLC/MAC control message which it knows to have been segmented using extended RLC/MAC control message segmentation - see Table 11.2.2.2) the message shall be formatted as an RLC/MAC control block. Otherwise, if sent as response to a Packet Polling Request message this latter message shall specify the format of the Packet Control Acknowledgement message. Otherwise the System Information parameter CONTROL\_ACK\_TYPE indicates which format the mobile station shall use. The order of bit transmission is defined in 3GPP TS 44.004. The numbering, assembling and field mapping conventions defined for RLC/MAC control blocks in sub-clause 10.0b shall apply.

The RLC/MAC control block format is shown in table 11.2.2.1 and table 11.2.2.2.

The access burst format is either 11-bit or 8-bit and is coded as shown in table 11.2.2.1. The mobile station shall use the format indicated by the System Information parameter ACCESS\_BURST\_TYPE. The mobile station shall transmit the access burst four times, one time in each TDMA frame of the uplink radio block.

Message type: PACKET CONTROL ACKNOWLEDGEMENT

Direction: mobile station to network

**Table 11.2.2.1: PACKET CONTROL ACKNOWLEDGEMENT**

<pre> &lt; Packet Control Acknowledgement message content &gt; ::= -- RLC/MAC control block format   &lt; TLLI/G-RNTI : bit (32) &gt;   &lt; CTRL_ACK : bit (2) &gt;   { null   0 bit** = &lt; no string &gt; -- Receiver backward compatible with earlier version of the protocol       1 -- Release 5 additions       { 0   1 &lt; TN_RRBP : bit (3) &gt; }       { 0   1 &lt; G-RNTI extension : bit (4) &gt; }       { null   0 bit** = &lt; no string &gt; -- Receiver backward compatible with earlier version of the protocol           1 -- Release 6 additions           { 0   1 &lt; CTRL_ACK_EXTENSION : bit (9) &gt; }         &lt; padding bits &gt; } } ;  &lt; Packet Control Acknowledgement 11 bit message &gt; ::= -- 11-bit access burst format   &lt; MESSAGE_TYPE : bit (9) == 1111 1100 1 &gt;     { &lt; MESSAGE_TYPE : bit (6) == 110111 &gt;       &lt; TN_RRBP : bit (3) &gt; }   &lt; CTRL_ACK : bit (2) &gt; ;  &lt; Packet Control Acknowledgement 8 bit message &gt; ::= -- 8-bit access burst format   &lt; MESSAGE_TYPE : bit (6) == 0111 11 &gt;     { &lt; MESSAGE_TYPE : bit (3) == 000 &gt;       &lt; TN_RRBP : bit (3) &gt; }   &lt; CTRL_ACK : bit (2) &gt; ; </pre>
---

**Table 11.2.2.2: PACKET CONTROL ACKNOWLEDGEMENT**

**TLLI/G-RNTI** (32 bit field)

This field contains the TLLI/G-RNTI of the mobile station. This field is encoded as defined in sub-clause 12.16.

**CTRL\_ACK** (2 bit field)

This field contains acknowledgement information for the group of RLC/MAC control blocks that make up an RLC/MAC control message. The mobile station shall set the CTRL\_ACK field to indicate which segments of an RLC/MAC control message have been received by the time of transmission of the PACKET CONTROL ACKNOWLEDGEMENT message.

This field can also be coded to contain the information if the mobile station is requesting the establishment of new TBF. This coding is allowed only when the message is sent in access burst format as a response to the PACKET UPLINK ACK/NACK message with Final Ack Indicator set to '1' and TBF Est is set to '1'.

If the PACKET CONTROL ACKNOWLEDGEMENT message is being transmitted in response to a valid RRBP field received as part of an RLC/MAC block with Payload Type equal to '10', the CTRL\_ACK field shall be set according to the following table:

bit

2 1

- |     |   |
|-----|---|
| 0 0 | in case the message is sent in access burst format, the same meaning as for the value '11' except that the mobile station is requesting new TBF. Otherwise the bit value '00' is reserved and shall not be sent. If received it shall be interpreted as bit value '01'. |
| 0 1 | the MS received an RLC/MAC control block addressed to itself and with RBSN = 1, and did not receive an RLC/MAC control block with the same RTI value and RBSN = 0.  |
| 1 0 | the MS received an RLC/MAC control block addressed to itself and with RBSN = 0, and did not receive an RLC/MAC control block with the same RTI value and RBSN = 1. This value is sent irrespective of the value of the FS bit.  |
| 1 1 | the MS received two RLC/MAC blocks with the same RTI value, one with RBSN = 0 and the other with RBSN = 1.  |

If the PACKET CONTROL ACKNOWLEDGEMENT message is being transmitted in response to a valid RRBP field received as part of an RLC/MAC block with Payload Type not equal to '10', the CTRL\_ACK field shall be set to the value '11' in case the message is sent in normal burst format or in case the mobile station is not requesting new TBF. In case the message is sent in access burst format and the mobile station is requesting new TBF, the CTRL\_ACK field shall be set to the value '00'.

If the PACKET CONTROL ACKNOWLEDGEMENT message is being transmitted in response to a polling request in an IMMEDIATE ASSIGNMENT message received on CCCH, the CTRL\_ACK field shall be set to the value '11'.

If the mobile station receives an RLC/MAC block with Payload Type equal to '10' and RLC/MAC block with Payload Type not equal to '10' with different RRBP values such that they specify the same uplink block, the mobile station shall set the CTRL\_ACK field according to the group of RLC/MAC control blocks that the RLC/MAC block with Payload Type equal to '10' belongs.

**CTRL\_ACK\_EXTENSION** (9 bit field)

This field contains acknowledgement information for the group of up to nine RLC/MAC control blocks that make up an RLC/MAC control message sent using extended RLC/MAC control message segmentation. The mobile station shall set the CTRL\_ACK\_EXTENSION field to indicate which segments of an RLC/MAC control message addressed to itself have been received by the time of transmission of the PACKET CONTROL ACKNOWLEDGEMENT message. Bit at index  $n$  in the CTRL\_ACK\_EXTENSION field indicates whether RLC/MAC control block "10 -  $n$ " has been received. This bit shall be set to "1" if the corresponding RLC/MAC control block has been received and to "0" otherwise. When CTRL\_ACK\_EXTENSION field is present, the CTRL\_ACK field shall be ignored. The CTRL\_ACK\_EXTENSION field shall be included only if the MS knows an RLC/MAC control message has been segmented using extended RLC/MAC control message segmentation (i.e. the MS has received at least one segment other than the first segment of an RLC/MAC control message segmented using extended RLC/MAC control message segmentation). The CTRL\_ACK\_EXTENSION field shall not be included if the MS has only received the first segment of an RLC/MAC control message and hence does not know whether extended RLC/MAC control message segmentation is used.

bit

9 8 7 6 5 4 3 2 1

0 0 0 0 0 0 0 0 0 this value is reserved and shall not be sent.

1 0 0 0 0 0 0 0 0 this value is reserved and shall not be sent.

...

0 0 1 0 1 0 0 0 0 the MS received the 3<sup>rd</sup> and 5<sup>th</sup> segments (i.e. with RBSN = "1" and RBSNe = "001" and RBSN = "1" and RBSNe = "011" respectively) of an RLC/MAC control message sent using a given RTI value and did not receive any other RLC/MAC control block(s) with other RBSN and RBSNe values having that same RTI value.

...

1 1 1 1 1 1 1 1 1 the MS received all nine segments of an RLC/MAC control message.

If the mobile station receives an RLC/MAC block with Payload Type equal to '10' and an RLC/MAC block with Payload Type not equal to '10' with different RRBPs such that they specify the same uplink block, the mobile station shall set the CTRL\_ACK\_EXTENSION field according to the group of RLC/MAC control blocks that the RLC/MAC block with Payload Type equal to '10' belongs to.

**TN\_RRBP** (3 bit field)

This field contains the timeslot number of the downlink PDCH on which the RRBPs were received. The TN\_RRBP field is coded as the binary representation of the timeslot number as defined in 3GPP TS 45.002.

**G-RNTI extension** (4 bit field)

This field contains the extra 4 bits of the G-RNTI not included in the TLLI / G-RNTI field which are necessary to provide a unique identifier in *lu mode*.

## 11.2.2a Packet Cell Change Continue

This message is sent on the PACCH by the network to the mobile station to command the mobile station to continue the cell reselection procedure.

Message type: PACKET CELL CHANGE CONTINUE

Direction: network to mobile station

Classification: non-distribution message

**Table 11.2.2a.1: PACKET CELL CHANGE CONTINUE message content**

```

< Packet Cell Change Continue message content > ::=
  < PAGE_MODE : bit (2) >
  { 0 < GLOBAL_TFI : Global TFI IE >
  { { 0 | 1 < ARFCN : bit (10) >
    < BSIC : bit (6) >
    < CONTAINER_ID : bit (2) > }
    < padding bits >
    ! < Non-distribution part error : bit (*) = < no string >> }
    ! < Address information part error : bit (*) = < no string >> }
    ! < Distribution part error : bit (*) = < no string >> ;

```

**Table 11.2.2a.2: PACKET CELL CHANGE CONTINUE information element details****PAGE\_MODE** (2 bit field)

This field is defined in sub-clause 12.20.

**Global TFI**

This information element contains the TFI of the mobile station's downlink TBF or uplink TBF. This field is defined in sub-clause 12.10.

The **ARFCN**, **BSIC** and the **CONTAINER\_ID** parameters shall be included if the network has earlier sent neighbour cell system information for the cell within a set of PACKET NEIGHBOUR CELL DATA messages referred by the corresponding CONTAINER\_ID value but without ARFCN and BSIC provided. Otherwise these parameters are optional.

**ARFCN** (10 bit field)

This field contains the BCCH frequency of the new cell candidate for re-selection. This field is encoded as the ARFCN defined in 3GPP TS 44.018.

Range 0 to 1023

**BSIC** (6 bit field)

This field contains the BSIC of the new cell candidate for re-selection. This field is encoded as the BSIC value defined in 3GPP TS 44.018.

Range 0 to 63

**CONTAINER\_ID** (2 bit field)

This field contains the identity of the neighbour cell system information container previously sent in the PACKET NEIGHBOUR CELL DATA message for the cell addressed by the ARFCN and the BSIC above.

Range 0 to 3

### 11.2.3 Packet Cell Change Failure

This message is sent on the PACCH from the mobile station to the network to indicate that a commanded cell change order has failed. For a (3G) multi-RAT mobile station this may be a 3G Cell. For a (E-UTRAN) multi-RAT mobile station this may be an E-UTRAN cell.

Message type: PACKET CELL CHANGE FAILURE

Direction: mobile station to network

**Table 11.2.3.1: PACKET CELL CHANGE FAILURE message content**

```

< Packet Cell Change Failure message content > ::=
  < TLLI / G-RNTI : bit (32) >
  < ARFCN : bit (10) >
  < BSIC : bit (6) >
  < CAUSE : bit (4) >
  { null | 0 bit ** = < no string > -- Receiver compatible with earlier release
    | 1 -- Additions in release 99 :
      { 0 | 1 < UTRAN FDD Target cell: < UTRAN FDD Target cell IE > > }
      { 0 | 1 < UTRAN TDD Target cell: < UTRAN TDD Target cell IE > > }
      { null | 0 bit ** = < no string > -- Receiver compatible with earlier release
        | 1 -- Additions in Rel-5 :
          { 0 | 1 < G-RNTI extension : bit (4) > }
          { null | 0 bit ** = < no string > -- Receiver compatible with earlier release
            | 1 -- Additions in Rel-8 :
              { 0 | 1 < E-UTRAN Target cell: < E-UTRAN Target cell IE > > }
              { null | 0 bit ** = < no string > -- Receiver compatible with earlier release
                | 1 -- Additions in Rel-9 :
                  { 0 | 1 < UTRAN CSG Target cell:
                    < UTRAN CSG Target cell IE > > }
                  { 0 | 1 < E-UTRAN CSG Target cell :
                    < E-UTRAN CSG Target cell IE > > }
                }
              }
            }
          }
        }
      }
    }
  }
  < padding bits > } } } } ;

```

**Table 11.2.3.2: PACKET CELL CHANGE FAILURE information element details**

<b>TLLI / G-RNTI</b> (32 bit field) This field is defined in sub-clause 12.16.																				
<b>ARFCN</b> (10 bit field) This field contains, in case of a GSM cell, the BCH frequency of the target cell on which the failure occurred. This field is encoded as the ARFCN defined in 3GPP TS 44.018. Range 0 to 1023 If a 3G Cell or an E-UTRAN Cell is indicated, this field shall be sent with the value 0																				
<b>BSIC</b> (6 bit field) This field contains, in case of a GSM cell, the BSIC of the BCH frequency of the target cell on which the failure occurred. This field is encoded as the BSIC value defined in 3GPP TS 44.018. Range 0 to 63 If a 3G Cell or an E-UTRAN Cell is indicated, this field shall be sent with the value 0.																				
<b>CAUSE</b> (4 bit field) This field indicates the cause of the cell change order failure on the target cell.  <table border="0"> <tr><td>bit</td><td></td></tr> <tr><td>4 3 2 1</td><td></td></tr> <tr><td>0 0 0 0</td><td>Frequency not implemented</td></tr> <tr><td>0 0 0 1</td><td>No response on target cell</td></tr> <tr><td>0 0 1 0</td><td>Immediate Assign Reject or Packet Access Reject on target cell</td></tr> <tr><td>0 0 1 1</td><td>On going CS connection</td></tr> <tr><td>0 1 0 0</td><td>PS Handover failure-other</td></tr> <tr><td>0 1 0 1</td><td>MS in GMM Standby state</td></tr> <tr><td>0 1 1 0</td><td>Forced to the Standby state</td></tr> <tr><td>All others</td><td>Reserved for future use</td></tr> </table>	bit		4 3 2 1		0 0 0 0	Frequency not implemented	0 0 0 1	No response on target cell	0 0 1 0	Immediate Assign Reject or Packet Access Reject on target cell	0 0 1 1	On going CS connection	0 1 0 0	PS Handover failure-other	0 1 0 1	MS in GMM Standby state	0 1 1 0	Forced to the Standby state	All others	Reserved for future use
bit																				
4 3 2 1																				
0 0 0 0	Frequency not implemented																			
0 0 0 1	No response on target cell																			
0 0 1 0	Immediate Assign Reject or Packet Access Reject on target cell																			
0 0 1 1	On going CS connection																			
0 1 0 0	PS Handover failure-other																			
0 1 0 1	MS in GMM Standby state																			
0 1 1 0	Forced to the Standby state																			
All others	Reserved for future use																			
<b>UTRAN FDD Target cell</b>  This information element contains the description of the UTRAN FDD Target cell. This information element is defined in sub-clause 12.31.																				

<b>UTRAN TDD Target cell</b> This information element contains the description of the UTRAN TDD Target cell. This field is defined in sub-clause 12.32.
<b>E-UTRAN Target cell</b> This information element contains the description of the E-UTRAN Target cell. This field is defined in sub-clause 12.49
<b>G-RNTI extension</b> (4 bit field) This field contains the extra 4 bits of the G-RNTI not included in the TLLI / G-RNTI field which are necessary to provide a unique identifier in <i>Iu mode</i> .
<b>UTRAN CSG Target cell</b> This information element contains the routing parameters for the UTRAN CSG or hybrid cell. It is defined in sub-clause 12.63.
<b>E-UTRAN CSG Target cell</b> This information element contains the routing parameters for the E-UTRAN CSG or hybrid cell. It is defined in sub-clause 12.62.

### 11.2.3a Packet Cell Change Notification

This message is sent on the PACCH by the mobile station to the network to inform the network that the cell re-selection criteria are now fulfilled and that the mobile station has entered CCN mode or that the criteria specified in sub-clause 5.6.3.9 have been met in respect of a CSG or detected hybrid cell.

Message type: PACKET CELL CHANGE NOTIFICATION

Direction: mobile station to network



Table 11.2.3a.1: PACKET CELL CHANGE NOTIFICATION message content

```

< Packet Cell Change Notification message content > ::=
  < Global TFI : < Global TFI IE > >
  { 0 < ARFCN : bit (10) >
    < BSIC : bit (6) >
  | 10    -- Extension in Rel-6 and an escape bit for future extensions of the message added:
    < 3G Target Cell : < 3G Target Cell Struct >> } -- Re-selection with a 3G cell as the preferred target cell
  | 110    -- Extension in Rel-8 for E-UTRAN and an escape bit for future extensions of the message
    { 0 | 1 < ARFCN : bit (10) >
      < BSIC : bit (6) > }
      { 0 | 1 < 3G Target Cell : < 3G Target Cell Struct >> }
      { 0 | 1 < E-UTRAN Target Cell : < E-UTRAN Target Cell Struct >> }
      { 0 | 1 < E-UTRAN CCN Measurement Report : < E-UTRAN CCN Measurement Report struct >> }
  | 1110    -- Extension in Rel-9 for CSG target cells and an escape bit for future extensions of the message
    { 0
      < UTRAN CSG Target Cell Measurement Report : < UTRAN CSG Measurement Report IE >>
    | 1
      < E-UTRAN CSG Target Cell Measurement Report : < E-UTRAN CSG Measurement Report IE >> }
      { 0 | 1 < E-UTRAN CCN Measurement Report : < E-UTRAN CCN Measurement Report struct >> }
  ! < Message escape : { 1111 } bit (*) = <no string>> }
  { 0 < BA_USED : bit > | 1 < PSI3_CHANGE_MARK : bit(2) > }
  < PMO_USED : bit >
  < PCCN_SENDING : bit (1) >
  < CCN Measurement Report : < CCN Measurement Report struct >>
  { null | 0 bit** = <no string> -- Receiver compatible with earlier release
  | 1 -- Addition in Rel-6
    { 0 | 1 < 3G_BA_USED : bit > }
    < 3G CCN Measurement Report : < 3G CCN Measurement Report struct >>
    { null | 0 bit** = <no string> -- Receiver compatible with earlier release
    | 1 -- Additions in Rel-10
      < CSG Discriminator : bit (1) >
      { null | 0 bit** = <no string> -- Receiver compatible with earlier release
      | 1 -- Additions in Rel-12
        { 0 | 1 < Downlink_eTFI : bit (3) > }
    }
  < padding bits > } } } ;

< CCN Measurement Report struct > ::=
  < RXLEV_SERVING_CELL : bit (6) >
  0 -- The value '1' was allocated in an earlier version of the protocol and shall not be used.
  < NUMBER_OF_NC_MEASUREMENTS : bit (3) >
  { < FREQUENCY_N : bit (6) >
    { 0 | 1 < BSIC_N : bit (6) > }
    < RXLEV_N : bit (6) > } * (val(NUMBER_OF_NC_MEASUREMENTS)) ;

< 3G Target Cell Struct > ::=
  { 0 | 1 < FDD-ARFCN : bit (14) > -- 3G UTRAN FDD
    { 0 | 1 < Bandwidth_FDD : bit (3) > }
    < SCRAMBLING_CODE : bit (9) > }
  { 0 | 1 < TDD-ARFCN : bit (14) > -- 3G UTRAN TDD
    { 0 | 1 < Bandwidth_TDD : bit (3) > }
    < Cell Parameter : bit (7) >
    < Sync Case : bit > }
  < REPORTING_QUANTITY : bit (6) > ; -- Measurement Report for 3G target cell

< 3G CCN Measurement Report Struct > ::= -- Measurement Report for 3G neighbour cells
  < N_3G : bit (3) >
  { < 3G_CELL_LIST_INDEX : bit (7) >
    < REPORTING_QUANTITY : bit (6) > } * (val(N_3G + 1)) ;

< E-UTRAN Target Cell struct > ::=
  < EARFCN : bit (16) >
  { 0 | 1 < Measurement Bandwidth : bit (3) > }
  < Physical Layer Cell Identity : bit (9) >
  < REPORTING_QUANTITY : bit (6) > ; -- Measurement Report for E-UTRAN target cell

```

```

< E-UTRAN CCN Measurement Report struct > ::= -- Measurement Report for E-UTRAN neighbour cells
  < 3G_BA_USED : bit >
  < N_E-UTRAN : bit (2) >
  {
    < E-UTRAN_FREQUENCY_INDEX : bit (3) >
    < CELL_IDENTITY : bit (9) >
    < REPORTING_QUANTITY : bit (6) > } * (val(N_E-UTRAN + 1) );

```

**Table 11.2.3a.2: PACKET CELL CHANGE NOTIFICATION information element details**

<p><b>Global TFI</b> This information element contains the TFI of the mobile station's downlink TBF or uplink TBF. This field is defined in sub-clause 12.10.</p>
<p><b>ARFCN</b> (10 bit field) This field contains the BCCH frequency of the proposed cell for re-selection. This field is encoded as the ARFCN defined in 3GPP TS 44.018. Range 0 to 1023</p>
<p><b>BSIC</b> (6 bit field) This field contains the BSIC of the proposed cell for re-selection. This field is encoded as the BSIC value defined in 3GPP TS 44.018. Range 0 to 63</p>
<p><b>BA_USED</b> (1 bit field)</p> <p><b>3G_BA_USED</b> (1 bit field)</p> <p><b>PSI3_CHANGE_MARK</b> (2 bit field)</p> <p>These fields shall be included and contain the value of the BA_IND, 3G_BA_IND and PSI3_CHANGE_MARK respectively in the messages defining the used GSM Neighbour Cell list.</p> <p>In case PBCCH exists, PSI3_CHANGE_MARK shall be used. In case PBCCH does not exist, BA_USED and 3G_BA_USED shall be used.</p>
<p><b>PMO_USED</b> (1 bit field) This parameter shall contain the value of the PMO_IND in the PACKET CELL CHANGE ORDER or PACKET MEASUREMENT ORDER messages that has modified the used GSM Neighbour Cell list. If no such message has been received, PMO_USED shall be set to zero.</p>
<p><b>CCN Measurement Report struct</b></p> <p>This struct is identical to the NC Measurement Report struct specified in the PACKET MEASUREMENT REPORT message with the exception that the NC_MODE parameter is not part of the struct.</p>
<p><b>PCCN SENDING</b> (1 bit field)</p> <p><b>0</b> This is the first sending of the Packet Cell Change Notification message; <b>1</b> This is the second sending of the Packet Cell Change Notification message.</p> <p>This field is used by the network to know whether the mobile station has just started T3208 or whether the reception of this message was triggered by T3210 expiry.</p>
<p><b>3G Target Cell struct</b> For information regarding the REPORTING QUANTITY see below. Regarding the other parameters see sub-clause 11.2.4 -PACKET CELL CHANGE ORDER message.</p>

<p><b>3G CCN Measurement Report struct</b> Measurement reporting for 3G Cells is defined in 3GPP TS 45.008.</p> <p><b>3G_CELL_LIST_INDEX</b> (7 bit field) This is the index of the i'th reported 3G neighbour cell in the 3G Neighbour Cell List. See sub-clause 5.6.3.1.</p> <p><b>REPORTING_QUANTITY</b> (6 bit field) This is the reporting quantity for the serving and for the i'th reported 3G cell. The quantities are defined in 3GPP TS 45.008 for the respective Radio Access Technology</p>
<p><b>E-UTRAN Target Cell struct</b> For information regarding the REPORTING QUANTITY see below. Regarding the other parameters see sub-clause 12.49.</p>
<p><b>E-UTRAN CCN Measurement Report struct</b> Measurement reporting for E-UTRAN Cells is defined in 3GPP TS 45.008.</p> <p><b>3G_BA_USED</b> (1 bit field) <b>N_E-UTRAN</b> (2 bit field) <b>E-UTRAN_FREQUENCY_INDEX</b> (3 bit field) <b>CELL_IDENTITY</b> (9 bit field) These fields are described in sub-clause 11.2.9.</p> <p><b>REPORTING_QUANTITY</b> (6 bit field) This is the reporting quantity for the E-UTRAN neighbour cell. The quantities are defined in 3GPP TS 45.008 for the respective Radio Access Technology.</p>
<p><b>UTRAN CSG Target Cell Measurement Report</b> Measurement reporting for UTRAN CSG cells is defined in 3GPP TS 45.008. This information element contains the measurement results and routing parameters for one UTRAN CSG or hybrid target cell. It is encoded as the UTRAN CSG Measurement Report IE defined in sub-clause 12.61.</p>
<p><b>E-UTRAN CSG Target Cell Measurement Report</b> Measurement reporting for E-UTRAN CSG cells is defined in 3GPP TS 45.008. This information element contains the measurement results and routing parameters for one E-UTRAN CSG or hybrid target cell. It is encoded as the E-UTRAN CSG Measurement Report IE defined in sub-clause 12.60.</p>
<p><b>CSG Discriminator</b> (1 bit field) This field is defined in sub-clause 5.6.3.9. It shall be included if the message includes a report for a CSG cell as specified in sub-clause 5.6.3.9, otherwise, it shall be omitted.</p>
<p><b>DOWNLINK_eTFI</b> (3 bit field) See sub-clause 11.2.48</p>

## 11.2.4 Packet Cell Change Order

This message is sent on the PCCCH or PACCH by the network to the mobile station to command the mobile station to leave the current cell and change to a new cell. For a (3G) multi-RAT mobile station the new cell may be a 3G Cell. For a (E-UTRAN) multi-RAT mobile station the new cell may be an E-UTRAN cell.

Message type: PACKET CELL CHANGE ORDER

Direction: network to mobile station

Classification: non-distribution message

Table 11.2.4.1: PACKET CELL CHANGE ORDER message content

```

< Packet Cell Change Order message content > ::=
< PAGE_MODE : bit (2) >
{
  { 0 < Global TFI : < Global TFI IE > >
    | 10 < TLLI / G-RNTI : bit (32) > }
  { 0
    { < IMMEDIATE_REL : bit >
      < GSM target cell: < GSM target cell struct >>
      ! < Non-distribution part error : bit (*) = < no string >> }
    | 1
      { 00 -- Message escape
        { < IMMEDIATE_REL : bit >
          { 0 | 1 < UTRAN FDD Target cell: < UTRAN FDD Target cell IE >> }
          { 0 | 1 < UTRAN TDD Target cell: < UTRAN TDD Target cell IE >> }
          { null | 0 bit ** = < no string > -- Receiver compatible with earlier release
            | 1 -- Additions in Rel-5 :
              { 0 | 1 < G-RNTI extension : bit (4) > }
              { null | 0 bit ** = < no string > -- Receiver compatible with earlier release
                | 1 -- Additions in Rel-8
                  { 0 | 1 < E-UTRAN Target cell : < E-UTRAN Target cell IE >> }
                  { 0 | 1 < Individual Priorities : < Individual Priorities IE >> }
                }
              }
            }
          }
        }
      }
    }
    ! < Non-distribution part error : bit (*) = < no string >> }
    ! < Message escape : { 01 | 10 | 11} bit (*) = < no string >> } }
    ! < Address information part error : bit (*) = < no string >> }
    ! < Distribution part error : bit (*) = < no string >> ;
  }
}

< GSM target cell struct > ::=
< ARFCN : bit (10) >
< BSIC : bit (6) >
< NC Measurement Parameters : < NC Measurement Parameters struct > >
{ null | 0 bit ** = < no string > -- Receiver compatible with earlier release
  | 1 -- Additions in release 98 :
    { 0 | 1 < LSA Parameters : < LSA Parameters IE >> }
    { null | 0 bit ** = < no string > -- Receiver compatible with earlier release
      | 1 -- Additions in release 99 :
        < ENH Measurement parameters : < ENH Measurement parameters struct >>
        { null | 0 bit ** = < no string > -- Receiver compatible with earlier release
          | 1 -- Additions in Rel-4 :
            < CCN_ACTIVE : bit (1) >
            { 0 | 1 < CONTAINER_ID : bit (2) > }
            { 0 | 1 < CCN Support Description : < CCN Support Description struct >> }
            { null | 0 bit ** = < no string > -- Receiver compatible with earlier release
              | 1 -- Additions in Rel-5 :
                { 0 | 1 < G-RNTI extension : bit (4) > }
                { 0 | 1 < lu Mode Neighbour Cell Parameters : { 1 < lu Mode Neighbour Cell params struct > } ** 0 >
                  --Supplementary information for dual lu mode and A/Gb mode capable cells
                }
                { 0 | 1 < NC lu MODE ONLY CAPABLE CELL LIST : NC lu Mode Only Cell List struct > }
                { 0 | 1 < GPRS 3G Additional Measurement Parameters Description 2 :
                  < GPRS 3G Additional Measurement Parameters Description 2 struct >> }
                { null | 0 bit ** = < no string > -- Receiver compatible with earlier release
                  | 1 -- Additions in Rel-6 :
                    < 3G_CCN_ACTIVE : bit (1) >
                    { null | 0 bit ** = < no string > -- Receiver compatible with earlier release
                      | 1 -- Additions in Rel-7 :
                        { 0 | 1 < 700_REPORTING_OFFSET : bit (3) >
                          < 700_REPORTING_THRESHOLD : bit (3) > }
                        { 0 | 1 < 810_REPORTING_OFFSET : bit (3) >
                          < 810_REPORTING_THRESHOLD : bit (3) > }
                        { null | 0 bit** = < no string > -- Receiver backward compatible with earlier version
                          | 1 -- Additions for Rel-8
                            < E-UTRAN_CCN_ACTIVE : bit (1) >
                            { 0 | 1 < Individual Priorities : < Individual Priorities IE >> }
                          }
                        }
                      }
                    }
                  }
                }
              }
            }
          }
        }
      }
    }
  }
}

```

```

< NC Measurement Parameters struct > ::=
  < NETWORK_CONTROL_ORDER : bit (2) >
  { 0 | 1 < NC_NON_DRX_PERIOD : bit (3) >
    < NC_REPORTING_PERIOD_I : bit (3) >
    < NC_REPORTING_PERIOD_T : bit (3) > }
  { 0 | 1 < NC_FREQUENCY_LIST : NC Frequency list struct > };

< NC Frequency list struct > ::=
  { 0 | 1 < NR_OF_REMOVED_FREQ : bit (5) >
    { < REMOVED_FREQ_INDEX : bit (6) > } * (1 + val(NR_OF_REMOVED_FREQ)) }
  { 1 < List of added Frequency : < Add Frequency list struct > } ** 0;

< Add Frequency list struct > ::=
  < START_FREQUENCY : bit (10) >
  < BSIC : bit (6) >
  { 0 | 1 < Cell selection params : < Cell Selection struct > > }
  < NR_OF_FREQUENCIES : bit (5) >
  < FREQ_DIFF_LENGTH : bit (3) >
  { < FREQUENCY_DIFF : bit (val(FREQ_DIFF_LENGTH)) > }
  < BSIC : bit (6) >
  { 0 | 1 < Cell selection params : < Cell Selection struct > > } * (val(NR_OF_FREQUENCIES));

< Cell Selection struct > ::=
  < CELL_BAR_ACCESS_2 : bit (1) >
  < EXC_ACC : bit >
  < SAME_RA_AS_SERVING_CELL : bit (1) >
  { 0 | 1 < GPRS_RXLEV_ACCESS_MIN : bit (6) >
    < GPRS_MS_TXPWR_MAX_CCH : bit (5) > }
  { 0 | 1 < GPRS_TEMPORARY_OFFSET : bit (3) >
    < GPRS_PENALTY_TIME : bit (5) > }
  { 0 | 1 < GPRS_RESELECT_OFFSET : bit (5) > }
  { 0 | 1 < HCS params : < HCS struct > > }
  { 0 | 1 < SI13_PBCCH_LOCATION : < SI13_PBCCH_LOCATION struct > > };

< SI13_PBCCH_LOCATION struct > ::=
  { 0 < SI13_LOCATION : bit (1) >
    | 1 < PBCCH_LOCATION : bit (2) >
    < PSI1_REPEAT_PERIOD : bit (4) > };

< HCS struct > ::=
  < PRIORITY_CLASS : bit (3) >
  < HCS_THR : bit (5) >;

< ENH Measurement parameters struct > ::=
  { 0 < BA_IND : bit > < 3G_BA_IND : bit > | 1 < PSI3_CHANGE_MARK : bit(2) > }
  < PMO_IND : bit >
  < REPORT_TYPE : bit >
  < REPORTING_RATE : bit >
  < INVALID_BSIC_REPORTING : bit >
  { 0 | 1 < 3G Neighbour Cell Description : < 3G Neighbour Cell Description struct >> }
  { 0 | 1 < GPRS REP PRIORITY Description : < GPRS REP PRIORITY Description struct >> }
  { 0 | 1 < GPRS MEASUREMENT Parameters Description :
    < GPRS MEASUREMENT PARAMETERS Description struct >> }
  { 0 | 1 < GPRS 3G MEASUREMENT Parameters Description :
    < GPRS 3G MEASUREMENT PARAMETERS Description struct >> };

< 3G Neighbour Cell Description struct > ::=
  { 0 | 1 < Index_Start_3G : bit (7) > }
  { 0 | 1 < Absolute_Index_Start_EMR : bit (7) > }
  { 0 | 1 < UTRAN FDD Description : < UTRAN FDD Description struct >> }
  { 0 | 1 < UTRAN TDD Description : < UTRAN TDD Description struct >> }
  { 0 | 1 < REMOVED_3GCELL_Description : < REMOVED_3GCELL_Description struct >> };

```

```

< REMOVED_3GCELL_Description struct > ::=
  < N1 : bit (2) >
  {
    < N2 : bit (5) >
    {
      < REMOVED_3GCELL_INDEX : bit (7) >
      < 3G_CELL_DIFF_LENGTH : bit (3) >
      < 3GCELL_DIFF : bit (val(3G_CELL_DIFF_LENGTH)) >
    } * (1+val(N2))
  } * (1+val(N1));

< UTRAN FDD Description struct > ::=
  { 0 | 1 < Bandwidth_FDD : bit (3) > }
  { 1 < Repeated UTRAN FDD Neighbour Cells : < Repeated UTRAN FDD Neighbour Cells struct >> } ** 0;

< Repeated UTRAN FDD Neighbour Cells struct > ::=
  0 < FDD-ARFCN : bit (14) >      -- The value "1" was used in an earlier
                                -- version of the protocol and shall not be used.
  < FDD_Indic0 : bit >
  < NR_OF_FDD_CELLS : bit (5) >
  < FDD_CELL_INFORMATION Field : bit(p(NR_OF_FDD_CELLS)) >;
                                -- p(x) defined in table 11.2.9b.2.a/3GPP TS 44.060

< UTRAN TDD Description struct > ::=
  { 0 | 1 < Bandwidth_TDD : bit (3) > }
  { 1 < Repeated UTRAN TDD Neighbour Cells : < Repeated UTRAN TDD Neighbour Cells struct >> } ** 0;

< Repeated UTRAN TDD Neighbour Cells struct > ::=
  0 < TDD-ARFCN : bit (14) >      -- The value "1" was used in an earlier
                                -- version of the protocol and shall not be used.
  < TDD_Indic0 : bit >
  < NR_OF_TDD_CELLS : bit (5) >
  < TDD_CELL_INFORMATION Field : bit(q(NR_OF_TDD_CELLS)) >;
                                -- q(x) defined in table 11.2.9b.2.b/3GPP TS 44.060.

< GPRS REP PRIORITY Description struct > ::=
  < Number_Cells : bit(7) >
  { < REP_PRIORITY : bit > } * (val(Number_Cells));

< GPRS MEASUREMENT PARAMETERS Description struct > ::=
  { 0 | 1 < MULTIBAND_REPORTING : bit (2) > }
  { 0 | 1 < SERVING_BAND_REPORTING : bit (2) > }
  < SCALE_ORD : bit(2) >

  { 0 | 1 < 900_REPORTING_OFFSET : bit (3) >
    < 900_REPORTING_THRESHOLD : bit (3) > }

  { 0 | 1 < 1800_REPORTING_OFFSET : bit (3) >
    < 1800_REPORTING_THRESHOLD : bit (3) > }

  { 0 | 1 < 400_REPORTING_OFFSET : bit (3) >
    < 400_REPORTING_THRESHOLD : bit (3) > }

  { 0 | 1 < 1900_REPORTING_OFFSET : bit (3) >
    < 1900_REPORTING_THRESHOLD : bit (3) > }

  { 0 | 1 < 850_REPORTING_OFFSET : bit (3) >
    < 850_REPORTING_THRESHOLD : bit (3) > } ;

```

```

< GPRS 3G MEASUREMENT PARAMETERS Description struct > ::=
  < Qsearch_P : bit (4) >
  { 1 ! < Ignore : bit = < no string >> }          -- this bit shall be ignored by the receiver
                                                    -- for backward compatibility with earlier releases
  { 0 | 1 < FDD_REP_QUANT : bit >
    < FDD_MULTIRAT_REPORTING : bit (2) > }          -- FDD Parameters

  { 0 | 1 < FDD_REPORTING_OFFSET : bit (3) >
    < FDD_REPORTING_THRESHOLD : bit (3) > }

  { 0 | 1 < TDD_MULTIRAT_REPORTING : bit (2) > }    -- TDD Parameters
  { 0 | 1 < TDD_REPORTING_OFFSET : bit (3) >
    < TDD_REPORTING_THRESHOLD : bit (3) > } ;

< CCN Support Description struct > ::=
  < Number_Cells : bit (7) >
  { CCN_SUPPORTED : bit } * (val(Number_Cells)) ;
< lu Mode Neighbour Cell Params struct > ::=
  { 0 | 1 < lu Mode Cell Selection Params : < lu Mode Cell Selection struct > > }
  { 0 | 1 < lu Mode Cell Selection Params :
    < lu Mode Cell Selection struct > > } * (val(NR_OF_FREQUENCIES)) ;
< lu Mode Cell Selection struct > ::=
  < CELL_BAR_QUALIFY_3 : bit (2) >
  { 0 | 1 < SI13Alt_PBCCH_Location : < SI13_PBCCH_Location struct > > } ;
< NC lu Mode Only Cell List struct > ::=
  { 1 < List of added cells : < Add lu Mode Only Cell List struct > > } ** 0 ;
< Add lu Mode Only Cell List struct > ::=
  < START_FREQUENCY : bit (10) >
  < BSIC : bit (6) >
  { 0 | 1 < Cell selection params : < lu Mode Only Cell Selection struct > > }
  < NR_OF_FREQUENCIES : bit (5) >
  < FREQ_DIFF_LENGTH : bit (3) >
  { < FREQUENCY_DIFF : bit (val(FREQ_DIFF_LENGTH)) >
  < BSIC : bit (6) >
  { 0 | 1 < Cell selection params : < lu Mode Only Cell Selection struct > > } } * (val(NR_OF_FREQUENCIES))
;
< lu Mode Only Cell Selection struct > ::=
  < CELL_BAR_QUALIFY_3 : bit (2) >
  < SAME_RA_AS_SERVING_CELL : bit (1) >
  { 0 | 1 < GPRS_RXLEV_ACCESS_MIN : bit (6) >
    < GPRS_MS_TXPWR_MAX_CCH : bit (5) > }
  { 0 | 1 < GPRS_TEMPORARY_OFFSET : bit (3) >
    < GPRS_PENALTY_TIME : bit (5) > }
  { 0 | 1 < GPRS_RESELECT_OFFSET : bit (5) > }
  { 0 | 1 < HCS params : < HCS struct > > }
  { 0 | 1 < SI13Alt_PBCCH_LOCATION : < SI13_PBCCH_LOCATION struct > > } ;

< GPRS 3G Additional Measurement Parameters Description 2 struct > ::=
  { 0 | 1 < FDD_REPORTING_THRESHOLD_2 : bit (6) > } ;          -- FDD Parameters

```

**Table 11.2.4.2: PACKET CELL CHANGE ORDER information element details**

<p><b>PAGE_MODE</b> (2 bit field) This field is defined in sub-clause 12.20.</p> <p><b>Global TFI</b> This information element contains the TFI of the mobile station's downlink TBF or uplink TBF. This field is defined in sub-clause 12.10.</p> <p><b>TLLI / G-RNTI</b> (32 bit field) This field is defined in sub-clause 12.16.</p>
<p><b>IMMEDIATE_REL</b> (1 bit field) This field indicates whether the MS shall immediately abort any operation in the old cell and move to the target cell (see sub-clause 8.4), or it shall not immediately abort operation in the old cell and follow the cell reselection procedure defined in sub-clause 5.5.1.1. This field is coded according to the following table:</p> <p>0 No immediate abort of operation in the old cell is required. 1 Immediate abort of operation in the old cell is required.</p>
<p><b>ARFCN</b> (10 bit field) This field contains the BCCH frequency of the new cell. This field is encoded as the ARFCN defined in 3GPP TS 44.018. Range 0 to 1023</p>
<p><b>BSIC</b> (6 bit field) This field contains the BSIC of the new cell. This field is encoded as the BSIC value defined in 3GPP TS 44.018. Range 0 to 63</p>
<p><b>CCN_ACTIVE</b> (1 bit field) This field indicates whether CCN is enabled towards GSM cells for the mobile station in the GSM cell addressed by ARFCN and BSIC. It is coded as follows: 0 The broadcast CCN_ACTIVE parameter shall apply if available. Otherwise, CCN is disabled for the mobile station. 1 CCN is enabled for the mobile station.</p>
<p><b>CONTAINER_ID</b> (2 bit field) This optional parameters is included only if the network has earlier sent neighbour cell system information for the cell addressed by the ARFCN and the BSIC. For detailed element definition see sub-clause 11.2.2.a.</p>
<p>The <b>NC_Measurement_Parameters struct</b> contains the NETWORK_CONTROL_ORDER and the optional parameters NC_NON_DRX_PERIOD, NC_REPORTING_PERIOD_I, NC_REPORTING_PERIOD_T and the NC_FREQUENCY_LIST. These parameters shall apply in the target cell (see sub-clause 5.6.1)</p>
<p><b>NETWORK_CONTROL_ORDER</b> (2 bit field) The NETWORK_CONTROL_ORDER field is coded according to the following table (for definition of NCx see 3GPP TS 45.008):</p> <p>bit 2 1 0 0 NC0 0 1 NC1 1 0 NC2 1 1 RESET</p>
<p><b>NC_NON_DRX_PERIOD</b> (3 bit field) <b>NC_REPORTING_PERIOD_I</b> (3 bit field) <b>NC_REPORTING_PERIOD_T</b> (3 bit field) For detailed element definitions see the PSI5 message.</p>



<p><b>NR_OF_REMOVED_FREQ</b> (5 bit field)  <b>REMOVED_FREQ_INDEX</b> (6 bit field)  <b>START_FREQUENCY</b> (10 bit field)  <b>BSIC</b> (6 bit field)  For detailed element definitions, see the Packet Measurement Order message</p>
<p><b>FREQ_DIFF_LENGTH</b> (3 bit field)  This field is required to calculate the number of bits to be used for the FREQUENCY_DIFF field in the current frequency group. The FREQ_DIFF_LENGTH value shall be different to 0.</p>
<p><b>FREQUENCY_DIFF</b> (val(FREQ_DIFF_LENGTH) bit field)  Each FREQUENCY_DIFF parameter field specifies the difference in frequency to the next carrier to be defined. The FREQUENCY_DIFF parameter encodes a non negative integer in binary format (W). Each frequency following the start frequency (ARFCN(0)) and belonging to the Frequency List struct is then calculated by the formula <math>ARFCN(n) = (ARFCN(n-1) + W(n)) \text{ modulus } 1024</math>, <math>n=1, \dots, \text{val}(\text{NR\_OF\_FREQUENCIES})</math>.</p>
<p><b>LSA Parameters</b>  This information element is defined in sub-clause 12.28. The 'LSA parameters IE' is optional. For detailed element definition, see the PSI3 message.</p>
<p><b>ENH Measurement Parameters:</b>  For detailed element definitions see the Packet Measurement Order message (except that CDMA2000 Description struct does not exist in this message).</p>
<p><b>UTRAN FDD Target cell</b>  This information element contains the description of the UTRAN FDD Target cell. This information element is defined in sub-clause 12.31.</p>
<p><b>UTRAN TDD Target cell</b>  This information element contains the description of the UTRAN TDD Target cell. This information element is defined in sub-clause 12.32.</p>
<p><b>E-UTRAN Target cell</b>  This information element contains the description of the E-UTRAN Target cell. This information element is defined in sub-clause 12.49.</p>
<p><b>GPRS MEASUREMENT PARAMETERS Description</b>  The fields of this Description are used for measurements, as defined in 3GPP TS 45.008.  Any parameter present overwrites any old data held by the mobile station for this parameter.</p>
<p><b>GPRS 3G MEASUREMENT PARAMETERS Description</b>  The fields of this Description are used for measurements, as defined in 3GPP TS 45.008.  Any parameter present overwrites any old data held by the mobile station for this parameter.</p>
<p><b>GPRS REP PRIORITY Description</b>  <b>REP_PRIORITY bit:</b>  <b>0</b> Normal reporting priority  <b>1</b> High reporting priority  The use of these bits is defined in sub-clause 5.6.3.5 and 3GPP TS 45.008.</p>
<p><b>CCN Support Description</b>  <b>CCN_SUPPORTED</b> (1 bit field)  This parameter is used for determining whether the mobile station shall enter CCN mode when re-selecting a GSM cell and CCN is enabled. The use of these bits is described in sub-clause 8.8.2a:  Bit  <b>0</b> CCN is enabled towards the corresponding cell  <b>1</b> CCN is disabled towards the corresponding cell</p>

<p><b>G-RNTI extension</b> (4 bit field)</p> <p>This field contains the extra 4 bits of the G-RNTI not included in the TLLI / G-RNTI field which are necessary to provide a unique identifier in <i>Iu mode</i>.</p>
<p><b><i>Iu Mode Neighbour Cell Parameters</i></b></p> <p>The <i>Iu mode Neighbour Cell Parameters</i> shall only be included when the <i>List of added Frequency struct</i> is present.</p>
<p><b><i>Iu Mode Neighbour Cell Params Struct</i></b></p> <p>This struct presents supplementary information for <i>Iu mode</i> capable cells. The struct assigns <i>Iu mode</i> parameter values to the neighbouring cells defined by the message. The <i>Iu mode Neighbour Cell params struct</i> values are assigned to the neighbouring cells in the same order they appear in the <i>List of added Frequency struct</i>.</p>
<p><b><i>NC Iu Mode Only Capable Cell List Parameters</i></b></p> <p>These parameters are used to add <i>Iu mode</i> only capable cells to BA(GPRS) list.</p>
<p><b>CELL BAR QUALIFY 3</b> (2 bit field)</p> <p>This information element is defined in 3GPP TS 44.018.</p>
<p><b><i>GPRS 3G Additional Measurement Parameters Description 2</i></b></p> <p>The fields of this Description are used for measurements, as defined in 3GPP TS 45.008. Any parameter present overwrites any old data held by the mobile station for this parameter.</p>
<p><b>3G_CCN_ACTIVE</b> (1 bit field)</p> <p>This field indicates whether CCN is enabled towards 3G neighbouring cells. It is coded as follows:</p> <p>0 The broadcast 3G_CCN_ACTIVE parameter shall apply if available. Otherwise, CCN towards 3G cells is disabled in the cell.</p> <p>1 CCN towards 3G cells is enabled in the cell.</p>
<p><b>700_REPORTING_OFFSET</b> (3 bit field)</p> <p><b>700_REPORTING_THRESHOLD</b> (3 bit field)</p> <p>These fields are used for measurements, as defined in 3GPP TS 45.008. Any parameter present overwrites any old data held by the mobile station for these parameters.</p>
<p><b>810_REPORTING_OFFSET</b> (3 bit field)</p> <p><b>810_REPORTING_THRESHOLD</b> (3 bit field)</p> <p>These fields are used for measurements, as defined in 3GPP TS 45.008. Any parameter present overwrites any old data held by the mobile station for these parameters.</p>
<p><b>E-UTRAN_CCN_ACTIVE</b> (1 bit field)</p> <p>This field indicates whether CCN is enabled towards E-UTRAN neighbouring cells in the target cell. For description and encoding see subclause 12.53.</p>
<p><b>Individual Priorities</b></p> <p>This information element is defined in sub-clause 12.50.</p>

## 11.2.5 Packet Channel Request

This message is sent in random mode on the PRACH using the PRACH uplink block format defined in 3GPP TS 44.004. The order of bit transmission is defined in 3GPP TS 44.004. The numbering, assembling and field mapping conventions defined for RLC/MAC control blocks in sub-clause 10.0b shall apply.

The message format is either 11-bit or 8-bit. The mobile station shall use the format indicated by the System Information parameter ACCESS\_BURST\_TYPE

The 11-bit format is coded as shown in table 11.2.5.1.

The 8-bit format is coded as shown in table 11.2.5.2.

Table 11.2.5.1: PACKET CHANNEL REQUEST 11 bit message content

<pre> &lt; Packet channel request 11 bit message content &gt; ::=   &lt; One Phase Access Request : 0 &lt; MultislotClass : bit (5) &gt;     &lt; Priority : bit (2) &gt;     &lt; RandomBits : bit (3) &gt; &gt;     &lt; Short Access Request : 100 -- The value 100 was allocated in an earlier version of the protocol and shall not   be used by the mobile station     &lt; NumberOfBlocks : bit (3) &gt;     &lt; Priority : bit (2) &gt;     &lt; RandomBits : bit (3) &gt; &gt;     &lt; Two Phase Access Request : 110000 &lt; Priority : bit (2) &gt;     &lt; RandomBits : bit (3) &gt; &gt;     &lt; Page Response : 110001 &lt; RandomBits : bit (5) &gt; &gt;     &lt; Cell Update : 110010 &lt; RandomBits : bit (5) &gt; &gt;     &lt; MM Procedure : 110011 &lt; RandomBits : bit (5) &gt; &gt;     &lt; Single Block Without TBF Establishment : 110100 &lt; RandomBits : bit (5) &gt; &gt;     &lt; One Phase Access Request in RLC unack mode : 110101 &lt; RandomBits : bit (5) &gt; &gt;     &lt; Dedicated channel request : 110110 &lt; RandomBits : bit (5) &gt; &gt;     &lt; Emergency call : 110111 &lt; RandomBits : bit (5) &gt; &gt;     &lt; Single block MBMS access : 111000 &lt; RandomBits : bit (5) &gt; &gt;; </pre>
---

Table 11.2.5.2: PACKET CHANNEL REQUEST 8 bit message content

<pre> &lt; Packet channel request 8 bit message content &gt; ::=   &lt; One Phase Access Request : 1 &lt; MultislotClass : bit (5) &gt;     &lt; RandomBits : bit (2) &gt; &gt;     &lt; Short Access Request : 00 -- The value 00 was allocated in an earlier version of the protocol and shall not be   used by the mobile station     &lt; NumberOfBlocks : bit (3) &gt;     &lt; RandomBits : bit (3) &gt; &gt;     &lt; Two Phase Access Request : 01000 &lt; RandomBits : bit (3) &gt; &gt;     &lt; Page Response : 01001 &lt; RandomBits : bit (3) &gt; &gt;     &lt; Cell Update : 01010 &lt; RandomBits : bit (3) &gt; &gt;     &lt; MM Procedure : 01011 &lt; RandomBits : bit (3) &gt; &gt;     &lt; Single Block Without TBF Establishment : 01100 &lt; RandomBits : bit (3) &gt; &gt;     &lt; One phase Access Request in RLC unack mode : 011010 &lt; RandomBits : bit (2) &gt; &gt;     &lt; Dedicated channel request : 011011 &lt; RandomBits : bit (2) &gt; &gt;     &lt; Emergency call : 011100 &lt; RandomBits : bit (2) &gt; &gt;     &lt; Single block MBMS access : 01111 &lt; RandomBits : bit (3) &gt; &gt;; </pre>
---

Table 11.2.5.3: PACKET CHANNEL REQUEST details

<b>MultislotClass</b> (5 bit field)	
This information field indicates the GPRS multislot class of the MS. The multislot class indicated by this field shall be the same as the GPRS multislot class indicated in the MS Radio Access Capability IE (see 3GPP TS 24.008). The coding is defined in the following table.	
bit	
5 4 3 2 1	
0 0 0 0	multislot class 1
0 0 0 1	multislot class 2
::	::
1 1 1 0 0	multislot class 29
other	reserved values

<p><b>Priority</b> (2 bit field)</p> <p>This information field indicates the requested Radio Priority. This field is coded as shown in the following table. The 8 bit format has a default Radio Priority of 4.</p> <p>bit</p> <p>2 1</p> <p>0 0      Radio Priority 1 (Highest priority)</p> <p>0 1      Radio Priority 2</p> <p>1 0      Radio Priority 3</p> <p>1 1      Radio Priority 4 (Lower priority)</p>
<p><b>NumberOfBlocks</b> (3 bit field)</p> <p>This information field indicates the number of blocks requested during a mobile originated Temporary Block Flow. This field is coded as shown in the following table:</p> <p>bit</p> <p>3 2 1</p> <p>0 0 0      1 RLC data block</p> <p>0 0 1      2 RLC data blocks</p> <p>...</p> <p>1 1 1      8 RLC data blocks</p>
<p><b>RandomBits</b> (2 bit field or 3 bit field or 5 bit field)</p> <p>This is an unformatted field.</p>

### 11.2.5a EGPRS Packet Channel Request

This message may be sent by an EGPRS capable mobile station in a cell supporting EGPRS and where the EGPRS\_PACKET\_CHANNEL\_REQUEST parameter indicates that this message shall be used.

This message is sent in random mode on the PRACH using the PRACH uplink block format or on the RACH (see 3GPP TS 44.018) using the RACH uplink / Uplink access burst block format defined in 3GPP TS 44.004. The order of bit transmission is defined in 3GPP TS 44.004. The numbering, assembling and field mapping conventions defined for RLC/MAC control blocks in sub-clause 10.0b shall apply. The message is coded in 11-bit format.

The EGPRS capability is indicated using alternative training sequences (see 3GPP TS 45.002).

**Table 11.2.5a.1: EGPRS PACKET CHANNEL REQUEST message content**

Training sequence (see 3GPP TS 45.002)	bits 11.....1	Packet Channel Access
TS1	< EGPRS Packet channel request message content >	EGPRS with 8PSK capability in uplink
TS2	< EGPRS Packet channel request message content >	EGPRS without 8PSK capability in uplink

**Table 11.2.5a.2: EGPRS PACKET CHANNEL REQUEST message content**

<b>&lt; EGPRS Packet channel request message content &gt; ::=</b>		
<b>&lt; One Phase Access Request :</b>	0	<b>&lt; MultislotClass :</b> bit (5) > <b>&lt; Priority :</b> bit (2) > <b>&lt; RandomBits :</b> bit (3) > > <i>-- The value 100 was allocated in an earlier version of the protocol and shall not be used by the mobile station</i>
<b>  &lt; Short Access Request :</b>	100	<b>&lt; NumberOfBlocks :</b> bit (3) > <b>&lt; Priority :</b> bit (2) > <b>&lt; RandomBits :</b> bit (3) > > 101 <b>&lt; MultislotClassGroup :</b> bit (3) >
<i>earlier version of the protocol and shall not be used by the mobile station</i>		
<b>  &lt; One Phase Access Request by Reduced Latency MS:</b>		<b>&lt; Priority :</b> bit (2) > <b>&lt; RandomBits :</b> bit (3) > >
<b>  &lt; Two Phase Access Request :</b>	110000	<b>&lt; Priority :</b> bit (2) > <b>&lt; RandomBits :</b> bit (3) > > <b>&lt; RandomBits :</b> bit (5) > >
<b>  &lt; Signalling :</b>	110011	<b>&lt; RandomBits :</b> bit (5) > >
<b>  &lt; One phase Access Request in RLC unack mode :</b>	110101	<b>&lt; RandomBits :</b> bit (5) > >
<b>  &lt; Dedicated Channel Request :</b>	110110	<b>&lt; RandomBits :</b> bit (5) > >
<b>  &lt; Emergency call :</b>	110111	<b>&lt; RandomBits :</b> bit (5) > >
<b>  &lt; Two Phase Access Request by IPA capable MS</b>	111000	<b>&lt; Priority :</b> bit (2) > <b>&lt; RandomBits :</b> bit (3) > >
<b>  &lt; Signalling by IPA capable MS :</b>	111001	<b>&lt; RandomBits :</b> bit (5) > >;

**Table 11.2.5a.3: EGPRS PACKET CHANNEL REQUEST details**

<b>MultislotClass</b> (5 bit field)	
This information field indicates the EGPRS multislot class of the MS. The multislot class indicated by this field shall be the same as the EGPRS multislot class indicated in the MS Radio Access Capability IE (see 3GPP TS 24.008). The coding is defined in the following table.	
bit	
5 4 3 2 1	
0 0 0 0 0	multislot class 1
0 0 0 0 1	multislot class 2
:: ::	
1 1 1 0 0	multislot class 29
1 1 1 0 1	multislot class with Tx=1 by IPA capable MS, the network shall assume the MS is multislot class 1
1 1 1 1 0	multislot class with Tx=2 by IPA capable MS, the network shall assume the MS is multislot class 5
1 1 1 1 1	multislot class with Tx=4 by IPA capable MS, the network shall assume the MS is multislot class 12
<b>Priority</b> (2 bit field)	
<b>NumberOfBlocks</b> (3 bit field)	
<b>RandomBits</b> (3 bit field or 5 bit field)	
For the definition of these three last information fields see Packet Channel Request in sec. 11.2.5.	

**MultislotClassGroup** (3 bit field)

This information field indicates the set of the EGPRS multislot classes to which the mobile station belongs. The network shall assume the longest transition times ( $T_{ta}$ ,  $T_{tb}$ ,  $T_{ra}$ ,  $T_{rb}$ ) and the minimum number of RX, TX and SUM slots common to multislot classes in each set for the assignments (see Annex L).

bit	multislot classes
3 2 1	
0 0 0	5-7
0 0 1	9-11
0 1 0	31, 36, 41
0 1 1	12, 32, 37, 42
1 0 0	33, 34, 43
1 0 1	38, 39
1 1 0	44, 45
1 1 1	reserved

### 11.2.5b Packet DBPSCH Assignment

This message is sent on the PCCCH or the PACCH from the network to the mobile station in *lu mode* to assign one or more DBPSCH(s) or a SDCCH to the mobile station.

Message type: PACKET DBPSCH ASSIGNMENT

Direction: network to mobile station

Classification: non-distribution message

Table 11.2.5b.1: PACKET DBPSCH ASSIGNMENT information elements

```

< Packet DBPSCH Assignment message content > ::=
< PAGE_MODE : bit (2) >
{ 0 | 1 < PERSISTENCE_LEVEL : bit (4) > * 4 }
{
  { 0 < Global TFI : < Global TFI IE > >
    | 10 < G-RNTI : bit (32) >
    | 11 < Packet Request Reference : < Packet Request Reference IE >> }
  { 0
    -- Message escape
    {
      < CHANNEL_DESCRIPTION : < Channel Description struct >>
      { 0 | 1 < TIMING_ADVANCE_VALUE : bit (8) > }
      < NETWORK_RESPONSE_TIMES : < Network Response Times struct >>
      < padding bits > -- truncation at end of message allowed, bits '0' assumed
      ! < Non-distribution part error : bit (*) = < no string >> }
      ! < Message escape : 1 bit (*) = < no string >> }
      ! < Address information part error : bit (*) = < no string >> }
      ! < Distribution part error : bit (*) = < no string >> ;
    }
}

< Channel Description struct > ::=
< CHANNEL_TYPE : bit (6) >
< DOWNLINK_TIMESLOT_ALLOCATION : bit (8) >
{ 0 -- Symmetric uplink and downlink timeslot allocation
| 1 < UPLINK_TIMESLOT_ALLOCATION : bit (8) > } -- Asymmetric uplink and downlink timeslot allocation
{ 0 | 1 < USF : bit (3) >
  < USF_GRANULARITY : bit (1) > }
< POWER_COMMAND : < Power Command struct >>
{ 0 | 1 < CHANNEL_MODE : bit (8) > }
< TSC : bit (3) >
{ 0 < MAIO : bit (6) >
  < HSN : bit (6) >
| 1 < ARFCN : bit (10) > } ;

< Network Response Times struct > ::=
{ 0 -- Network's response times on SDCCH
  < RESPONSE_TIME_SDCCH : < Response Time SDCCH struct >>
| 1 -- Network's response times on the assigned DBPSCH
  < RESPONSE_TIME_SACCH : < Response Time SACCH struct >> -- Network's response time on SACCH
  { 0 -- Network's response time on FACCH/F
    -- i.e. between a request sent on TCH/F or FACCH/F and the corresponding response sent on FACCH/F
    < RESPONSE_TIME_FACCH_F : < Response Time struct >>
  | 1 < RESPONSE_TIME_FACCH_H : < Response Time struct >>}; -- Network's response time on FACCH/H

< Response Time SDCCH struct > ::=
< TRMIN_SDCCH : bit (1) > -- Network's minimum response time on SDCCH
< TRESP_SDCCH : bit (1) >; -- Network's maximum response time on SDCCH

< Response Time SACCH struct > ::=
< TRMIN_SACCH : bit (1) > -- Network's minimum response time on SACCH
< TRESP_SACCH : bit (1) >; -- Network's maximum response time on SACCH

< Response Time struct > ::=
< TRMIN : bit (6) >
< TRESP_MAC_DTM : bit (7) >
< TRESP_MAC_Dedicated : bit (7) >;

< Power Command struct > ::= -- Provides the power level to be used by the mobile station
{ 0 -- Normal power control
| 1 < FPC_EPC : bit (1) > } -- Fast or Enhanced Power Control
< POWER_LEVEL : bit (8) >;

```

Table 11.2.5b.2: PACKET DBPSCH ASSIGNMENT information elements details

<b>PAGE_MODE</b> (2 bit field) This field is defined in sub-clause 12.20.
<b>PERSISTENCE_LEVEL</b> (4 bit field for each Radio Priority 1...4) This field is defined in sub-clause 12.14, PRACH Control Parameters.
<b>Global TFI</b> This information element contains one of the mobile station's downlink or uplink TFIs. This field is defined in sub-clause 12.10.

<p><b>G-RNTI</b> (32 bit field) This field is defined in sub-clause 12.16.</p>														
<p><b>Packet_Request_Reference</b> This information element is defined in sub-clause 12.11</p>														
<p><b>CHANNEL_TYPE</b> (6 bit field) This field indicates the type of channel allocated to the mobile station on DBPSCH. The T bits indicate the subchannel number coded in binary. See 3GPP TS 45.002.</p> <p>bit</p> <table> <tr> <td>6 5 4 3 2 1</td> <td></td> </tr> <tr> <td>0 0 0 0 T T</td> <td>SDCCH/4 + SACCH/C4</td> </tr> <tr> <td>0 0 1 T T T</td> <td>SDCCH/8 + SACCH/C8</td> </tr> <tr> <td>0 1 0 0 0 0</td> <td>TCH/F + FACCH/F + SACCH/F</td> </tr> <tr> <td>0 1 0 0 1 T</td> <td>TCH/H + FACCH/H + SACCH/TH</td> </tr> <tr> <td>0 1 0 1 0 0</td> <td>PDTCH/F + PACCH/F + SACCH/F</td> </tr> <tr> <td>All other values</td> <td>Reserved</td> </tr> </table>	6 5 4 3 2 1		0 0 0 0 T T	SDCCH/4 + SACCH/C4	0 0 1 T T T	SDCCH/8 + SACCH/C8	0 1 0 0 0 0	TCH/F + FACCH/F + SACCH/F	0 1 0 0 1 T	TCH/H + FACCH/H + SACCH/TH	0 1 0 1 0 0	PDTCH/F + PACCH/F + SACCH/F	All other values	Reserved
6 5 4 3 2 1														
0 0 0 0 T T	SDCCH/4 + SACCH/C4													
0 0 1 T T T	SDCCH/8 + SACCH/C8													
0 1 0 0 0 0	TCH/F + FACCH/F + SACCH/F													
0 1 0 0 1 T	TCH/H + FACCH/H + SACCH/TH													
0 1 0 1 0 0	PDTCH/F + PACCH/F + SACCH/F													
All other values	Reserved													
<p><b>DOWNLINK_TIMESLOT_ALLOCATION</b> (8 bit field) This field is coded as the Timeslot Allocation field defined in sub-clause 12.18. The uplink timeslot allocation is identical to the downlink timeslot allocation given in this field in case the UPLINK_TIMESLOT_ALLOCATION field is not included.</p> <p>NOTE: Multislot allocation is only possible with a CHANNEL_TYPE indicating TCH or PDTCH.</p>														
<p><b>UPLINK_TIMESLOT_ALLOCATION</b> (8 bit field) This field is coded as the Timeslot Allocation field defined in sub-clause 12.18. It is included only in case of asymmetric timeslot allocation between downlink and uplink.</p> <p>NOTE: Multislot allocation is only possible with a CHANNEL_TYPE indicating TCH or PDTCH.</p>														
<p><b>CHANNEL_MODE</b> (8 bit field) This field is coded as the mode part of the channel mode IE defined in 3GPP TS 44.018. It shall be included only in case a TCH is assigned to the mobile station.</p>														
<p><b>TSC</b> (3 bit field) This field is the binary representation of the training sequence code, see 3GPP TS 45.002.</p> <p>Range: 0 to 7.</p>														
<p><b>MAIO</b> (6 bit field) This field is the binary representation of the mobile allocation index offset (MAIO), see 3GPP TS 45.002.</p> <p>Range: 0 to 63.</p>														
<p><b>HSN</b> (6 bit field) This field is the binary representation of the hopping sequence number, see 3GPP TS 45.002.</p> <p>Range: 0 to 63.</p>														
<p><b>ARFCN</b> (10 bit field) This field is the binary representation of the absolute radio frequency channel number (ARFCN) defined in 3GPP TS 45.005.</p> <p>Range 0 to 1023.</p>														
<p><b>TIMING_ADVANCE_VALUE</b> (8 bit field) This field is defined in 3GPP TS 44.018.</p>														



<p><b>TRMIN_SDCCH</b> (1 bit field)</p> <p>This field indicates the minimum response time of the network on SDCCH, expressed as a number of TDMA frames. See 3GPP TS 44.160.</p> <p>Bit</p> <p>1</p> <p>0 32</p> <p>1 83</p>
<p><b>TRESP_SDCCH</b> (1 bit field)</p> <p>This field indicates the maximum response time of the network on SDCCH, expressed as a number of TDMA frames. See 3GPP TS 44.160.</p> <p>Bit</p> <p>1</p> <p>0 134</p> <p>1 185</p>
<p><b>TRMIN_SACCH</b> (1 bit field)</p> <p>This field indicates the minimum response time of the network on SACCH, expressed as a number of TDMA frames. See 3GPP TS 44.160.</p> <p>Bit</p> <p>1</p> <p>0 25</p> <p>1 129</p>
<p><b>TRESP_SACCH</b> (1 bit field)</p> <p>This field indicates the maximum response time of the network on SACCH, expressed as a number of TDMA frames. See 3GPP TS 44.160.</p> <p>Bit</p> <p>1</p> <p>0 129</p> <p>1 233</p>
<p><b>TRMIN</b> (6 bit field)</p> <p>This field indicates the minimum response time of the network, expressed as a number of TDMA frames. See 3GPP TS 44.160.</p> <p>Bit</p> <p>6 5 4 3 2 1</p> <p>0 0 0 0 0 0 9</p> <p>0 0 0 0 0 1 10</p> <p>...</p> <p>1 1 1 1 1 1 72</p>
<p><b>TRESP_MAC_DTM</b> (7 bit field)</p> <p><b>TRESP_MAC_Dedicated</b> (7 bit field)</p> <p>These fields indicate for a given MAC state the maximum response time of the network expressed as a number of TDMA frames. See 3GPP TS 44.160.</p> <p>Bit</p> <p>7 6 5 4 3 2 1</p> <p>0 0 0 0 0 0 0 14</p> <p>0 0 0 0 0 0 1 15</p> <p>...</p> <p>1 1 1 1 1 1 1 141</p>

<p><b>FPC_EPC</b> (1 bit field)</p> <p>This field indicates whether fast power control or enhanced power control (see 3GPP TS 45.008) shall be used. It is coded as follows:</p> <p>Bit</p> <p>1</p> <p>0 FPC in use</p> <p>1 EPC in use</p>
<p><b>POWER_LEVEL</b> (8 bit field)</p> <p>This field is coded as the binary representation of the "power control level", see 3GPP TS 45.005. This value shall be used by the mobile station according to 3GPP TS 45.008.</p> <p>Range: 0 to 31</p>
<p><b>USF</b> (3 bit field)</p> <p>This field indicates the USF value assigned to the MS for all assigned timeslots (range 0 to 7). This field is encoded as a binary representation of the USF value as defined in sub-clause 10.4.1.</p>
<p><b>USF_GRANULARITY</b> (1 bit field)</p> <p>This information field indicates the USF granularity to be applied by the mobile station on DBPSCH.</p> <p>0 the mobile station shall transmit one RLC/MAC block</p> <p>1 the mobile station shall transmit four consecutive RLC/MAC blocks</p>

### 11.2.5c MPRACH Packet Channel Request

This message is sent in random mode on the MPRACH using the PRACH uplink block format defined in 3GPP TS 44.004. The order of bit transmission is defined in 3GPP TS 44.004. The numbering, assembling and field mapping conventions defined for RLC/MAC control blocks in sub-clause 10.0b shall apply.

The message is coded as shown in table 11.2.5c.1.

**Table 11.2.5c.1: MPRACH PACKET CHANNEL REQUEST message content**

<p>&lt; MPRACH Packet channel request message content &gt; ::=</p> <p>&lt; <b>Single block MBMS access</b>: 0000 &lt; <b>RandomBits</b>: bit (7) &gt; &gt;;</p>
---

**Table 11.2.5c.2: MPRACH PACKET CHANNEL REQUEST details**

<p><b>RandomBits</b> (7 bit field)</p> <p>This is an unformatted field.</p>
---

### 11.2.6 Packet Downlink Ack/Nack

This message is sent on the PACCH from the mobile station to the network to indicate the status of downlink RLC data blocks received and to report the channel quality of the downlink. The mobile station may optionally initiate an uplink TBF.

Message type: PACKET DOWNLINK ACK/NACK

Direction: mobile station to network

Table 11.2.6.1: PACKET DOWNLINK ACK/NACK information elements

```

< Packet Downlink Ack/Nack message content > ::=
  < DOWNLINK_TFI : bit (5) >
  < Ack/Nack Description : < Ack/Nack Description IE > >
  { 0 | 1 < Channel Request Description : < Channel Request Description IE > > }
  < Channel Quality Report : < Channel Quality Report struct > >
  { null | 0 bit** = <no string> -- Receiver backward compatible with earlier version
    | 1 -- Additional contents for Release 1999
    { 0 | 1 < PFI : bit(7) > }
    { null | 0 bit** = < no string > -- Receiver backward compatible with earlier version
      | 1 -- Additions for REL-5
      { 0 | 1 < Iu mode Channel Request Description : < Iu mode Channel Request Description IE > > }
      { 0 | 1 < RB Id : bit (5) > }
      { 0 | 1 < Timeslot Number : bit (3) > }
      { null | 0 bit** = <no string> -- Receiver backward compatible with earlier version
        | 1 -- Additional contents for Release 6
        { 0 | 1 < Extended Channel Request Description : < Extended Channel Request Description IE > > }
        { null | 0 bit** = <no string> -- Receiver backward compatible with earlier version
          | 1 -- Additional contents for Release 7
          < EARLY_TBF_ESTABLISHMENT : bit (1) >
        }
      }
    }
  < padding bits > } };

< Channel Quality Report struct > ::=
  < C_VALUE : bit (6) >
  < RXQUAL : bit (3) >
  < SIGN_VAR : bit (6) >
  { 0 | 1 < I_LEVEL_TN0 : bit (4) > }
  { 0 | 1 < I_LEVEL_TN1 : bit (4) > }
  { 0 | 1 < I_LEVEL_TN2 : bit (4) > }
  { 0 | 1 < I_LEVEL_TN3 : bit (4) > }
  { 0 | 1 < I_LEVEL_TN4 : bit (4) > }
  { 0 | 1 < I_LEVEL_TN5 : bit (4) > }
  { 0 | 1 < I_LEVEL_TN6 : bit (4) > }
  { 0 | 1 < I_LEVEL_TN7 : bit (4) > };

```

Table 11.2.6.2: PACKET DOWNLINK ACK/NACK information element details

<p><b>DOWNLINK_TFI</b> (5 bit field)</p> <p>This field contains the TFI of the mobile station's downlink TBF. This field is defined in sub-clause 12.15. On DBPSCH, this field equals the radio bearer identity of the radio bearer to which this message applies.</p> <p><b>Ack/Nack Description</b></p> <p>This information element is defined in sub-clause 12.3.</p> <p><b>Channel Request Description</b></p> <p>This information element is defined in sub-clause 12.7. If a PFI field is included in this message, it relates to the TBF request contained in the <i>Channel Request Description</i> IE. Neither this IE nor the PFI field shall be included if the <i>Extended Channel Request Description</i> IE is included.</p> <p><b>Iu mode Channel Request Description</b></p> <p>This information element is defined in sub-clause 12.7a.</p> <p><b>Extended Channel Request Description</b></p> <p>This information element is defined in sub-clause 12.7b. This IE contains a request for one or more additional uplink TBFs and shall only be included if the mobile station and the network support multiple TBF procedures. If this IE is included, the <i>Channel Request Description</i> IE and PFI field in the message shall be omitted.</p>
<p><b>C_VALUE</b> (6 bit field)</p> <p>This field is encoded as the binary representation of the C value as specified in 3GPP TS 45.008. Range 0 to 63</p>

<p><b>RXQUAL</b> (3 bit field)</p> <p>This field contains the RXQUAL parameter field calculated by the mobile station (see 3GPP TS 45.008). This field is encoded as defined in 3GPP TS 44.018.</p> <p>Range 0 to 7</p>														
<p><b>PFI</b> (7 bit field)</p> <p>This field contains the PFI parameter identifying a Packet Flow Context relating to the resource request specified in the <i>Channel Request Description IE</i>. The PFI parameter is encoded as the contents of the PFI information element as defined in 3GPP TS 44.018. This field may be included if the network supports packet flow context procedures and if a Channel Request Description IE is included in the message. If this field is included but the <i>Channel Request Description IE</i> is omitted, this field shall be ignored.</p>														
<p><b>SIGN_VAR</b> (6 bit field)</p> <p>This field contains the signal variance parameter SIGN_VAR calculated by the mobile station (see 3GPP TS 45.008).</p> <p>bit</p> <table> <tr><td>6 5 4 3 2 1</td><td></td></tr> <tr><td>0 0 0 0 0 0</td><td>0dB<sup>2</sup> to 0.25 dB<sup>2</sup></td></tr> <tr><td>0 0 0 0 0 1</td><td>&gt;0.25 dB<sup>2</sup> to 0.50 dB<sup>2</sup></td></tr> <tr><td>0 0 0 0 1 0</td><td>&gt;0.50 dB<sup>2</sup> to 0.75 dB<sup>2</sup></td></tr> <tr><td>:::</td><td>::</td></tr> <tr><td>1 1 1 1 1 0</td><td>&gt;15.50 dB<sup>2</sup> to 15.75 dB<sup>2</sup></td></tr> <tr><td>1 1 1 1 1 1</td><td>&gt;15.75 dB<sup>2</sup></td></tr> </table>	6 5 4 3 2 1		0 0 0 0 0 0	0dB <sup>2</sup> to 0.25 dB <sup>2</sup>	0 0 0 0 0 1	>0.25 dB <sup>2</sup> to 0.50 dB <sup>2</sup>	0 0 0 0 1 0	>0.50 dB <sup>2</sup> to 0.75 dB <sup>2</sup>	:::	::	1 1 1 1 1 0	>15.50 dB <sup>2</sup> to 15.75 dB <sup>2</sup>	1 1 1 1 1 1	>15.75 dB <sup>2</sup>
6 5 4 3 2 1														
0 0 0 0 0 0	0dB <sup>2</sup> to 0.25 dB <sup>2</sup>													
0 0 0 0 0 1	>0.25 dB <sup>2</sup> to 0.50 dB <sup>2</sup>													
0 0 0 0 1 0	>0.50 dB <sup>2</sup> to 0.75 dB <sup>2</sup>													
:::	::													
1 1 1 1 1 0	>15.50 dB <sup>2</sup> to 15.75 dB <sup>2</sup>													
1 1 1 1 1 1	>15.75 dB <sup>2</sup>													
<p><b>I_LEVEL_TN0</b> (4 bit field)</p> <p><b>I_LEVEL_TN1</b> (4 bit field)</p> <p><b>I_LEVEL_TN2</b> (4 bit field)</p> <p><b>I_LEVEL_TN3</b> (4 bit field)</p> <p><b>I_LEVEL_TN4</b> (4 bit field)</p> <p><b>I_LEVEL_TN5</b> (4 bit field)</p> <p><b>I_LEVEL_TN6</b> (4 bit field)</p> <p><b>I_LEVEL_TN7</b> (4 bit field)</p> <p>These fields contain the I_LEVEL value measured on timeslots 0 through 7, respectively. The I_LEVEL is defined in 3GPP TS 45.008 and the coding of I_LEVEL is as follows:</p> <p>bit</p> <table> <tr><td>4 3 2 1</td><td></td></tr> <tr><td>0 0 0 0</td><td>I_LEVEL 0</td></tr> <tr><td>0 0 0 1</td><td>I_LEVEL 1</td></tr> <tr><td>...</td><td></td></tr> <tr><td>1 1 1 0</td><td>I_LEVEL 14</td></tr> <tr><td>1 1 1 1</td><td>I_LEVEL 15</td></tr> </table>	4 3 2 1		0 0 0 0	I_LEVEL 0	0 0 0 1	I_LEVEL 1	...		1 1 1 0	I_LEVEL 14	1 1 1 1	I_LEVEL 15		
4 3 2 1														
0 0 0 0	I_LEVEL 0													
0 0 0 1	I_LEVEL 1													
...														
1 1 1 0	I_LEVEL 14													
1 1 1 1	I_LEVEL 15													
<p><b>RB Id</b> (5 bit field)</p> <p>This field contains the radio bearer identity of the mobile station's radio bearer for which the downlink data transfer on SFACCH is acknowledged. This field is not included when the PACKET DOWNLINK ACK/NACK message is sent on DBPSCH. This field is encoded as a binary number with range 0-31</p>														
<p><b>Timeslot Number</b> (3 bit field)</p> <p>It contains the timeslot number of the timeslot on which the corresponding RRBP was received. This field shall be included if and only if the timeslot number of the PDTCH/SBPSCH on which the PACKET DOWNLINK ACK/NACK message is sent is different from the timeslot number of each of the timeslots assigned to this TBF in the direction of this TBF. This field is encoded as the binary representation of the timeslot number as defined in 3GPP TS 45.002.</p>														
<p><b>EARLY_TBF_ESTABLISHMENT</b> (1 bit field)</p> <p>This field indicates whether or not the channel request is meant to request pre-allocation of an uplink TBF:</p> <p>0 The channel request is not meant to pre-allocate an uplink TBF.</p> <p>1 The channel request is meant to pre-allocate an uplink TBF.</p>														

## 11.2.6a EGPRS Packet Downlink Ack/Nack

This message is sent on the PACCH from the mobile station to the network to indicate the status of downlink RLC data blocks received and to report the channel quality of the downlink. The mobile station may optionally initiate an uplink TBF or request a temporary suspension of the downlink TBF.

Message type: EGPRS Packet Downlink Ack/Nack

Direction: mobile station to network

**Table 11.2.6a.1 : EGPRS PACKET DOWNLINK ACK/NACK information elements**

```

< EGPRS Packet Downlink Ack/Nack message content > ::=
  < DOWNLINK_TFI : bit (5) >
  < MS OUT OF MEMORY : bit(1)>
  { 0 | 1 < EGPRS Channel Quality Report : < EGPRS Channel Quality Report IE > > }
  { 0 | 1 < Channel Request Description : >Channel Request Description IE > > }
  { 0 | 1 < PFI : bit(7) > }
  { 0 | 1 < EPD A/N Extension length index : bit (6) >
    < bit (expanded_EPDAN_extension_length(val(EPD A/N Extension length index)))
      & { < EPD A/N Extension Info > ! { bit** = <no string> } } > }
  < EGPRS Ack/Nack Description : < EGPRS Ack/Nack Description IE > >
  < padding bits > } ;
< EPD A/N Extension Info > ::=
  { {
    -- Rel-5 extension
    { 0 | 1 < lu mode Channel Request Description : < lu mode Channel Request Description IE > > }
    { 0 | 1 < RB Id : bit (5) > }
    { 0 | 1 < Timeslot Number : bit (3) > } }
  {
    -- Rel-6 extension
    { 0 | 1 < Extended Channel Request Description : < Extended Channel Request Description IE > > } }
  {
    -- Rel-7 extension
    < EARLY_TBF_ESTABLISHMENT : bit (1) >
    { 0 | 1 < Secondary Dual Carrier Channel Report : < EGPRS Channel Quality Report IE > > } }
  < spare bit > ** } // ;
  -- Truncation may occur between released versions of the protocol
  -- The receiver shall assume the value zero of any truncated bits

```

**Table 11.2.6a.1a : expanded\_EP DAN\_extension\_length function**

```

/*
 * The expanded_EP DAN_extension_length function returns the actual length of
 * the EPD A/N Extension Info IE computed as follows:
 * - if index_value >= 6 or the mobile station is NOT assigned a dual carrier
 *   configuration, the length is index_value +1 (for sizes ranging from 1 to 64 bits)
 * - if index_value < 6 and the mobile station is assigned a dual carrier configuration,
 *   the length is index_value +65 (for "expanded" sizes ranging from 65 to 70 bits)
 *
 * The description of the function in ANSI C language is provided herein for illustration.
 *
 * Parameter:
 *   index:      index ranging from 0 to 63 and representative of the actual IE size
 *
 * Returned value: actual (expanded) size of the IE
 */

unsigned char expanded_EP DAN_extension_length (unsigned char index)
{
/* Indicates whether the mobile station is assigned a DLDC configuration (1) or not (0) */
extern unsigned char DLDC_configuration;

    unsigned char L;

    if ((index >= 6) OR (DLDC_configuration == 0))
        L = index + 1;
    else
        L = index + 65;

    return (L);
}

```

**Table 11.2.6a.2: EGPRS PACKET DOWNLINK ACK/NACK information element details****DOWNLINK\_TFI** (5 bit field)

This field contains the TFI of the mobile station's downlink TBF. This field is defined in sub-clause 12.15. On DBPSCH, this field equals the radio bearer identity of the radio bearer to which this message applies.

**EGPRS Ack/Nack Description IE** (L bit field)

This information element is defined in sub-clause 12.3.1. The number of bits (L) available for Ack/Nack Description information element depends on the inclusion of channel quality reports and channel requests. L shall be set so that the entire EGPRS PACKET DOWNLINK ACK/NACK message evenly fits into an RLC/MAC control block. If a lower L covers the entire receive window, that L shall be used.

**MS OUT OF MEMORY** (1 bit field)

This field indicates that the MS has no more enough memory to perform Incremental Redundancy.

- 0 The MS has enough memory
- 1 The MS is running out of memory

<p><b>Channel Request Description IE</b> This information element is defined in sub-clause 12.7. If a PFI field is included in this message, it relates to the TBF request contained in the <i>Channel Request Description IE</i>. Neither this IE nor the PFI field shall be included if the <i>Extended Channel Request Description IE</i> is included.</p> <p><b>Iu mode Channel Request Description IE</b> This information element is defined in sub-clause 12.7a.</p> <p><b>Extended Channel Request Description</b> This information element is defined in sub-clause 12.7b. This IE contains a request for one or more additional uplink TBFs and shall only be included if the mobile station and the network support multiple TBF procedures. If this IE is included, the <i>Channel Request Description IE</i> and PFI field in the message shall be omitted.</p> <p><b>EGPRS Channel Quality Report IE</b> This information element is defined in sub-clause 12.5.1. For a mobile station with a dual carrier downlink assignment, this IE shall contain measurements corresponding to the downlink carrier which is paired with the uplink carrier on which this message is being sent.</p>
<p><b>PFI</b> (7 bit field) This field contains the PFI parameter identifying a Packet Flow Context relating to the resource request specified in the Channel Request Description IE. The PFI parameter is encoded as the contents of the PFI information element as defined in 3GPP TS 44.018. This field may be included if the network supports packet flow context procedures and if a Channel Request Description IE is included in the message. If this field is included but the Channel Request Description IE is omitted, this field shall be ignored.</p>
<p><b>RB Id</b> (5 bit field) This field contains the radio bearer identity of the mobile station's radio bearer for which the downlink data transfer on SFACCH is acknowledged. This field is not included when the EGPRS PACKET DOWNLINK ACK/NACK message is sent on DBPSCH. This field is encoded as a binary number with range 0-31.</p>
<p><b>Timeslot Number</b> (3 bit field) It contains the timeslot number of the timeslot on which the corresponding RRBP was received. This field shall be included if and only if the timeslot number of the PDTCH/SBPSCH on which the EGPRS PACKET DOWNLINK ACK/NACK message is sent is different from the timeslot number of each of the timeslots assigned to this TBF in the direction of this TBF. This field is encoded as the binary representation of the timeslot number as defined in 3GPP TS 45.002.</p>
<p><b>EARLY_TBF_ESTABLISHMENT</b> (1 bit field) This field indicates whether or not the channel request is meant to request pre-allocation of an uplink TBF:</p> <p>0 The channel request is not meant to pre-allocate an uplink TBF. 1 The channel request is meant to pre-allocate an uplink TBF.</p>
<p><b>Secondary Dual Carrier Channel Report</b> This information element is described in sub-clause 12.5.1. For a mobile station with a dual carrier downlink assignment, this IE shall contain measurements corresponding to the downlink carrier which is not paired with the uplink carrier on which this message is being sent. This IE shall not be included by an MS with a single carrier downlink assignment.</p>

### 11.2.6b Packet DBPSCH Downlink Ack/Nack

This message is sent on FACCH, SACCH or SDCCH from the mobile station to the network to indicate the status of downlink RLC data blocks received.

Message type: PACKET DBPSCH DOWNLINK ACK/NACK

Direction: mobile station to network

**Table 11.2.6b.1: PACKET DBPSCH DOWNLINK ACK/NACK information elements**

<pre> &lt; Packet DBPSCH Downlink Ack/Nack message &gt; ::=   &lt; MESSAGE_TYPE : bit (6) == 000010 &gt;   &lt; RB Id : bit (5) &gt;   { 0 -- TCH TBF mode     { 0 - All data blocks acknowledged, no retransmission requested         1 &lt; STARTING_SEQUENCE_NUMBER : bit (8) &gt;         &lt; RECEIVED_BLOCK_BITMAP : bit (128) &gt; }       1 -- DCCH TBF mode       { 0 - All data blocks acknowledged, no retransmission requested           1 &lt; STARTING_SEQUENCE_NUMBER : bit (4) &gt;           &lt; RECEIVED_BLOCK_BITMAP : bit (8) &gt; } }   &lt;padding bits &gt; ; </pre>
--

**Table 11.2.6b.2: PACKET DBPSCH DOWNLINK ACK/NACK information element details**

<p><b>RB Id</b> (5 bit field)</p> <p>This field contains the radio bearer identity of the mobile station's radio bearer for which the downlink data transfer is acknowledged. This field is encoded as a binary number with range 0-31.</p>
<p><b>STARTING_SEQUENCE_NUMBER</b> (8 or 4 bit field)</p> <p>The SSN contains the value of V(R) when this information element was transmitted. This field is encoded as the binary representation of V(R).</p> <p>Range 0 to 255 (8 bit field)</p> <p>Range 0 to 15 (4 bit field)</p>
<p><b>RECEIVE_BLOCK_BITMAP (RBB)</b> (128 or 8 bit field)</p> <p>The RBB is a bitmap representing Block Sequence Numbers. The bitmap is indexed relative to SSN as follows:</p> <p style="padding-left: 40px;">BSN = (SSN - bit_number) modulo 256, for bit_number = 1 to 128 (128 bit field).</p> <p style="padding-left: 40px;">BSN = (SSN - bit_number) modulo 16, for bit_number = 1 to 8 (8 bit field).</p> <p>The BSN values represented range:</p> <p style="padding-left: 40px;">from (SSN - 1) mod 256 to (SSN - 128) mod 256 (128 bit field)</p> <p style="padding-left: 40px;">from (SSN - 1) mod 16 to (SSN - 8) mod 16 (8 bit field)</p> <p>The value of each bit represents the acknowledgement status of the RLC data block with:</p> <p style="padding-left: 40px;">BSN = (SSN - bit_number) mod 256 (128 bit field)</p> <p style="padding-left: 40px;">BSN = (SSN - bit_number) mod 16 (8 bit field),</p> <p>it is encoded as follows:</p> <p style="padding-left: 40px;">0    Negative acknowledgement</p> <p style="padding-left: 40px;">1    Positive acknowledgement</p> <p>Mapping of the bitmap is defined in 3GPP TS 44.160.</p>

## 11.2.6c Packet DBPSCH Downlink Ack/Nack Type 2

This message shall only be used when FLO is used. It is sent on ADCH from the mobile station to the network to indicate the status of downlink RLC data blocks received.

Message type:    PACKET DBPSCH DOWNLINK ACK/NACK TYPE 2

Direction:        mobile station to network



**Table 11.2.6c.1: PACKET DBPSCH DOWNLINK ACK/NACK TYPE 2 information elements**

<pre> &lt; Packet DBPSCH Downlink Ack/Nack Type 2 message &gt; ::=   &lt; MESSAGE_TYPE : bit (6) == 000010 &gt; -- The same message type as for Packet DBPSCH Downlink Ack/Nack is     -- used since these two messages are mutually exclusive    &lt; RB Id : bit (5) &gt;   &lt; EGPRS Channel Quality Report : &lt; EGPRS Channel Quality Report IE &gt; &gt;   { 0 -- UDCH TBF mode     { 0 -- All data blocks acknowledged, no retransmission requested         1 &lt; FLO Ack/Nack Description : &lt; FLO Ack/Nack Description IE &gt; &gt; }       1 -- CDCH TBF mode       { 0 -- All data blocks acknowledged, no retransmission requested           1 &lt; STARTING_SEQUENCE_NUMBER : bit (4) &gt;           &lt; RECEIVED_BLOCK_BITMAP : bit (8) &gt; } }   &lt;padding bits &gt; ; </pre>
---

**Table 11.2.6c.2: PACKET DBPSCH DOWNLINK ACK/NACK TYPE 2 information element details**

<p><b>RB Id</b> (5 bit field)</p> <p>This field contains the radio bearer identity of the mobile station's radio bearer for which the downlink data transfer is acknowledged. This field is encoded as a binary number with range 0-31.</p>
<p><b>FLO Ack/Nack Description IE</b> (x bit field)</p> <p>This information element is defined in sub-clause 12.3.2.</p>
<p><b>STARTING_SEQUENCE_NUMBER</b> (4 bit field)</p> <p>The SSN contains the value of V(R) when this information element was transmitted. This field is encoded as the binary representation of V(R). Range 0 to 15</p>
<p><b>RECEIVE_BLOCK_BITMAP (RBB)</b> (128 or 8 bit field)</p> <p>The RBB is a bitmap representing Block Sequence Numbers. The bitmap is indexed relative to SSN as follows:</p> <p style="padding-left: 40px;"><math>BSN = (SSN - bit\_number) \text{ modulo } 16</math>, for <math>bit\_number = 1 \text{ to } 8</math> (8 bit field).</p> <p>The BSN values represented range:</p> <p style="padding-left: 40px;">from <math>(SSN - 1) \text{ mod } 16</math> to <math>(SSN - 8) \text{ mod } 16</math> (8 bit field)</p> <p>The value of each bit represents the acknowledgement status of the RLC data block with:</p> <p style="padding-left: 40px;"><math>BSN = (SSN - bit\_number) \text{ mod } 16</math> (8 bit field),</p> <p>it is encoded as follows:</p> <p style="padding-left: 40px;">0    Negative acknowledgement 1    Positive acknowledgement</p> <p>Mapping of the bitmap is defined in 3GPP TS 44.160.</p>

## 11.2.6d MBMS Downlink Ack/Nack

This message is sent on the PACCH from the mobile station to the network to indicate the status of downlink RLC data blocks received, to report neighbouring cell measurements and to notify the network of the release of the MS\_ID on the mobile station side.

Message type:    MBMS Downlink Ack/Nack

Direction:        mobile station to network

Table 11.2.6d.1: MBMS DOWNLINK ACK/NACK information elements

```

< MBMS Downlink Ack/Nack message content > ::=
  < DOWNLINK_TFI : bit (5) >
  < MBMS Neighbouring Cell Report : < MBMS Neighbouring Cell Report struct > > -- Neighbouring cell reporting
  < MS_ID Release Indication : bit (1) >
  { 0 | 1 < Extension Bits : Extension Bits IE > } -- sub-clause 12.26
  { 0 < Ack/Nack Description : < Ack/Nack Description IE > > -- Ack/Nack information
  | 1 < MS_OUT_OF_MEMORY : bit (1) >
    < EGPRS Ack/Nack Description : < EGPRS Ack/Nack Description IE > > }
  <padding bits > ;

< MBMS Neighbouring Cell Report struct > ::=
  { 0 < BA_USED : bit (1) >
  | 1 < PSI3_CHANGE_MARK : bit (2) > }
  < Neighbouring Cell Report : < Neighbouring Cell Report struct > >;

< Neighbouring Cell Report struct > ::=
  < RXLEV_SERVING_CELL : bit (6) > -- Serving cell Rx level
  < RESEL_CRITERIA_FULFILLED : bit (1) > -- If re-selection criteria are fulfilled, only the
  -- corresponding neighbouring cell is reported

  < NUMBER_OF_NEIGHBOURING_CELL_MEASUREMENTS : bit (3) >
  {
    < NCELL_LIST_INDEX_N : bit (7) > -- Neighbouring cells Rx levels
    { 0 | 1 < BSIC_N : bit (6) > }
    < RXLEV_N : bit (6) >
    < RESEL_PARAMS_ACQUIRED : bit (1) >
    { 0 -- No ptm parameters acquired for that session
    -- in that cell
    | 1 < MBMS_PTM_CHANGE_MARK : bit (2) > } -- Ptm parameters acquired for that session in
    -- that cell
  }
  * val (NUMBER_OF_NEIGHBOURING_CELL_MEASUREMENTS);

```

Table 11.2.6d.2: MBMS DOWNLINK ACK/NACK information element details

<p><b>DOWNLINK_TFI</b> (5 bit field)</p> <p>This field contains the TFI identifying the mobile station sending this message (i.e. the concatenation of the MBMS Bearer ID and the MS_ID).</p>
<p><b>MS_ID Release Indication</b> (1 bit field)</p> <p>This field is used by the mobile station to notify the network of the release of the MS_ID, for the MBMS radio bearer the message relates to, on the mobile station side.</p> <p>0 The MS_ID is not released on the mobile station side 1 The MS_ID is released on the mobile station side</p>
<p><b>Extension Bits</b></p> <p>This information element, if present, shall be skipped over. Any information content shall be ignored by the network. This information element is defined in sub-clause 12.26.</p>
<p><b>Ack/Nack Description IE</b></p> <p>This information element is defined in sub-clause 12.3.</p>
<p><b>MS OUT OF MEMORY</b> (1 bit field)</p> <p>This field indicates that the MS has no more enough memory to perform Incremental Redundancy.</p> <p>0 The MS has enough memory 1 The MS is running out of memory</p>
<p><b>EGPRS Ack/Nack Description IE</b> (L bit field)</p> <p>This information element is defined in sub-clause 12.3.1. The number of bits (L) available for Ack/Nack Description information element may depend on the number of neighbouring cell measurements included (see sub-clause 9.1.8.2.1). L shall be set so that the entire MBMS DOWNLINK ACK/NACK message evenly fits into an RLC/MAC control block. If a lower L covers the entire receive window, that L shall be used.</p>

<p><b>BA_USED</b> (1 bit field)</p> <p><b>PSI3_CHANGE_MARK</b> (2 bit field)</p> <p>These fields shall contain the value of BA_IND and PSI3_CHANGE_MARK respectively in the message defining the used Neighbour Cell List.</p> <p>In case PBCCH exists, PSI3_CHANGE_MARK shall be used. In case PBCCH does not exist, BA_USED shall be used.</p>
<p><b>RXLEV_SERVING_CELL</b> (6 bit field)</p> <p>This field contains the value of the RXLEV parameter for the serving cell calculated by the mobile station (see 3GPP TS 45.008). This field is encoded as the binary representation of the RXLEV parameter value defined in 3GPP TS 45.008.</p> <p>Range 0 to 63.</p>
<p><b>Neighbouring cell reporting</b></p> <p>The reporting of neighbouring cell measurement results is done in decreasing order of the corresponding cell re-selection ranking, as described in sub-clause 5.6.4. In case cell re-selection criteria are fulfilled, only the measurement results for the corresponding neighbouring cell are included and no other measurement results for any other neighbouring cell are included.</p>
<p><b>RESEL_CRITERIA_FULFILLED</b> (1 bit field)</p> <p>This field indicates whether cell re-selection criteria are fulfilled.</p> <p><u>Bit</u></p> <p>0 Cell re-selection criteria are not fulfilled 1 Cell re-selection criteria are fulfilled</p>
<p><b>NUMBER_OF_NEIGHBOURING_CELL_MEASUREMENTS</b> (3 bit field)</p> <p>This field is encoded as the binary representation of the amount of neighbouring cells reported.</p> <p><u>Bit</u></p> <p><u>3 2 1</u> 0 0 0 0 ... .. 1 0 1 5 1 1 x 6</p>
<p><b>NCELL_LIST_INDEX_N</b> (7 bit field)</p> <p>This field contains the index of the GSM Neighbour Cell list, see sub-clause 5.6.3.2. As an exception, if PBCCH is not present in the cell and the MS has not acquired the complete GSM Neighbour Cell list from the BCCH messages, this field shall refer to the BA(BCCH) list.</p>
<p><b>BSIC_N</b> (6 bit field)</p> <p>This field indicates the BSIC of the frequency upon which the measurement was made. This field shall be included only for frequencies that refer to the BA(BCCH) list. The field is encoded as the BSIC value defined in 3GPP TS 44.018.</p> <p>Range 0 to 63</p>
<p><b>RXLEV_N</b> (6 bit field)</p> <p>This field indicates the measured RXLEV of the frequency upon which the measurement was made (see 3GPP TS 45.008). This field is encoded as the RXLEV value defined in 3GPP TS 44.018.</p> <p>Range 0 to 63</p>
<p><b>RESEL_PARAMS_ACQUIRED</b> (1 bit field)</p> <p>This field indicates whether the mobile station has received the re-selection parameters for the reported neighbouring cell.</p> <p><u>Bit</u></p> <p>0 No re-selection parameters received for this neighbouring cell 1 Re-selection parameters received for this neighbouring cell</p>

**MBMS\_PTM\_CHANGE\_MARK** (2 bit field)

This field shall contain the value of the MBMS\_PTM\_CHANGE\_MARK field in the latest MBMS NEIGHBOURING CELL INFORMATION message received by the mobile station for that MBMS session and that reported neighbouring cell. If no such MBMS\_PTM\_CHANGE\_MARK is available, it shall not be included in the MBMS DOWNLINK ACK/NACK message.

## 11.2.6e EGPRS Packet Downlink Ack/Nack Type 2

This message is sent on the PACCH from the mobile station to the network to indicate the status of downlink RLC data blocks received and to report the channel quality of the downlink. The mobile station may optionally initiate an uplink TBF or request a temporary suspension of the downlink TBF.

Message type: EGPRS Packet Downlink Ack/Nack Type 2

Direction: mobile station to network

**Table 11.2.6e.1 : EGPRS PACKET DOWNLINK ACK/NACK TYPE 2 information elements**

```

< EGPRS Packet Downlink Ack/Nack Type 2 message content > ::=
  < DOWNLINK_TFI : bit (5) >
  < MS OUT OF MEMORY : bit(1)>
  { 0 | 1 < EGPRS Channel Quality Report Type 2 : < EGPRS Channel Quality Report Type 2 IE > > }
  { 0 | 1 < Channel Request Description : < Channel Request Description IE > > }
  { 0 | 1 < PFI : bit(7) > }
  { 0 | 1 < EPD A/N Type 2 Extension length : bit (8) >
    < bit (val(EPD A/N Type 2 Extension length) + 1)
    & { < EPD A/N Type 2 Extension Info > ! { bit** = <no string> } } > }

  -- Truncation of the EGPRS Ack/Nack Description is allowed if the mobile station is assigned a downlink
  -- dual carrier configuration and the available space in the message without EGPRS Ack/Nack Description IE
  -- does not allow for the inclusion of a valid EGPRS Ack/Nack Description IE, i.e. is less than 16 bits.
  -- In the same conditions, the receiver shall assume that no EGPRS Ack/Nack description IE is included.
  { < EGPRS Ack/Nack Description : < EGPRS Ack/Nack Description IE >> } //
  <padding bits > } ;
< EPD A/N Type 2 Extension Info > ::=
  { 0 | 1 < Extended Channel Request Description : < Extended Channel Request Description IE > > }
  < EARLY_TBF_ESTABLISHMENT : bit (1) >
  { 0 | 1 < Secondary Dual Carrier Channel Report : < EGPRS Channel Quality Report Type 2 IE > }
  < spare bit > ** // ;
  -- Truncation may occur between released versions of the protocol
  -- The receiver shall assume the value zero of any truncated bits

```

**Table 11.2.6e.2: EGPRS PACKET DOWNLINK ACK/NACK TYPE 2 information element details**

**DOWNLINK\_TFI** (5 bit field)

This field contains the TFI of the mobile station's downlink TBF. This field is defined in sub-clause 12.15. On DBPSCH, this field equals the radio bearer identity of the radio bearer to which this message applies.

**EGPRS Ack/Nack Description IE** (L bit field)

This information element is defined in sub-clause 12.3.1. The number of bits (L) available for Ack/Nack Description information element depends on the inclusion of channel quality reports and channel requests. L shall be set so that the entire EGPRS PACKET DOWNLINK ACK/NACK message evenly fits into an RLC/MAC control block. If a lower L covers the entire receive window, that L shall be used.

**MS OUT OF MEMORY** (1 bit field)

This field indicates that the MS has no more enough memory to perform Incremental Redundancy.

0 The MS has enough memory

1 The MS is running out of memory

**Channel Request Description IE**

This information element is defined in sub-clause 12.7. If a PFI field is included in this message, it relates to the TBF request contained in the *Channel Request Description IE*. Neither this IE nor the PFI field shall be included if the *Extended Channel Request Description IE* is included.

**Extended Channel Request Description**

This information element is defined in sub-clause 12.7b. This IE contains a request for one or more additional uplink TBFs and shall only be included if the mobile station and the network support multiple TBF procedures. If this IE is included, the *Channel Request Description IE* and PFI field in the message shall be omitted.

**EGPRS Channel Quality Report Type 2 IE**

This information element is defined in sub-clause 12.5a.1. For a mobile station with a dual carrier downlink assignment, this IE shall contain measurements corresponding to the downlink carrier which is paired with the uplink carrier on which this message is being sent.

**PFI (7 bit field)**

This field contains the PFI parameter identifying a Packet Flow Context relating to the resource request specified in the *Channel Request Description IE*. The PFI parameter is encoded as the contents of the PFI information element as defined in 3GPP TS 44.018. This field may be included if the network supports packet flow context procedures and if a *Channel Request Description IE* is included in the message. If this field is included but the *Channel Request Description IE* is omitted, this field shall be ignored.

**EARLY\_TBF\_ESTABLISHMENT (1 bit field)**

This field indicates whether or not the channel request is meant to request pre-allocation of an uplink TBF:

- 0 The channel request is not meant to pre-allocate an uplink TBF.
- 1 The channel request is meant to pre-allocate an uplink TBF.

**Secondary Dual Carrier Channel Report**

This information element is described in sub-clause 12.5a.1. For a mobile station with a dual carrier downlink assignment, this IE shall contain measurements corresponding to the downlink carrier which is not paired with the uplink carrier on which this message is being sent. This IE shall not be included by an MS with a single carrier downlink assignment.

## 11.2.6f EGPRS Packet Downlink Ack/Nack Type 3

This message is sent on the PACCH from the mobile station to the network to indicate the status of downlink RLC data blocks received and to report the channel quality of the downlink.

This message shall only be used by the mobile station if indicated as supported by the network according to the value of the *EGPRS Packet Downlink Ack/Nack Type 3 Support* field in assignment messages.

Message type: EGPRS Packet Downlink Ack/Nack Type 3

Direction: mobile station to network

**Table 11.2.6f.1: EGPRS PACKET DOWNLINK ACK/NACK TYPE 3 information elements**

```

< EGPRS Packet Downlink Ack/Nack Type 3 message content > ::=
  < DOWNLINK_TFI : bit (5) >
  < MS OUT OF MEMORY : bit(1)>
  { 0 | 1 < EGPRS Channel Quality Report : < EGPRS Channel Quality Report Type 2 IE > >}
  { 0 | 1 < Secondary Dual Carrier Channel Report : < EGPRS Channel Quality Report Type 2 IE > >}
  {
    { 0 | 1 < Extension Bits : Extension Bits IE > }          -- sub-clause 12.26

    -- Truncation of the EGPRS Ack/Nack Description is allowed
    -- if the available space in the message without EGPRS Ack/Nack Description IE
    -- does not allow for the inclusion of a valid EGPRS Ack/Nack Description IE, i.e. is less than 16 bits.
    -- In these conditions, the receiver shall assume that no EGPRS Ack/Nack description IE is included.
    < EGPRS Ack/Nack Description : < EGPRS Ack/Nack Description IE >>
  } // -- Truncation allowed (specific conditions apply for the EGPRS Ack/Nack Description - see above)
  <padding bits > ;

```

**Table 11.2.6f.2: EGPRS PACKET DOWNLINK ACK/NACK TYPE 3 information element details**

<p><b>DOWNLINK_TFI</b> (5 bit field) This field contains the TFI of the mobile station's downlink TBF. This field is defined in sub-clause 12.15. On DBPSCH, this field equals the radio bearer identity of the radio bearer to which this message applies.</p> <p><b>MS OUT OF MEMORY</b> (1 bit field) This field indicates that the MS has no more enough memory to perform Incremental Redundancy.</p> <p>0 The MS has enough memory 1 The MS is running out of memory</p> <p><b>EGPRS Channel Quality Report</b> This information element is defined in sub-clause 12.5a.1. For a mobile station with a dual carrier downlink assignment, this IE shall contain measurements corresponding to the downlink carrier which is paired with the uplink carrier on which this message is being sent.</p> <p><b>Secondary Dual Carrier Channel Report</b> This information element is described in sub-clause 12.5a.1. For a mobile station with a dual carrier downlink assignment, this IE shall contain measurements corresponding to the downlink carrier which is not paired with the uplink carrier on which this message is being sent. This IE shall only be included by an MS in a Downlink Dual Carrier configuration.</p> <p><b>EGPRS Ack/Nack Description</b> (L bit field) This information element is defined in sub-clause 12.3.1. The number of bits (L) available for Ack/Nack Description information element depends on the inclusion of channel quality reports and channel requests. L shall be set so that the entire EGPRS PACKET DOWNLINK ACK/NACK message fits into an RLC/MAC control block. If a lower L covers the entire receive window, that L shall be used.</p>
--

## 11.2.7 Packet Downlink Assignment

This message is sent on the PCCCH or PACCH by the network to the mobile station to assign downlink resources to the mobile station. If the mobile station supports Downlink Dual Carrier or Downlink Multi Carrier, this message may be sent using extended RLC/MAC control message segmentation (see sub-clause 9.1.12a).

A mobile allocation or reference frequency list received as part of this assignment message shall be valid until a new assignment is received or each TBF of the MS are terminated.

Message type: PACKET DOWNLINK ASSIGNMENT

Direction: network to mobile station

Classification: non-distribution message

Table 11.2.7.1: PACKET DOWNLINK ASSIGNMENT information elements

<pre> &lt; Packet Downlink Assignment message content &gt; ::= &lt; PAGE_MODE : bit (2) &gt; { 0   1 &lt; PERSISTENCE_LEVEL : bit (4) &gt; * 4 } {   { 0 &lt; Global TFI : &lt; Global TFI IE &gt; &gt;       10 &lt; TLLI/ G-RNTI : bit (32) &gt; }   { 0 -- Message escape     {       &lt; MAC_MODE : bit (2) &gt;       &lt; RLC_MODE : bit (1) &gt;       &lt; CONTROL_ACK : bit (1) &gt;       &lt; TIMESLOT_ALLOCATION : bit (8) &gt;       &lt; Packet Timing Advance : &lt; Packet Timing Advance IE &gt; &gt;       { 0   1 &lt; PO : bit (4) &gt;         0 -- The value '1' was allocated in an earlier version of the protocol and shall not be used.         &lt; PR_MODE : bit (1) &gt; }       {         { 0   1 &lt; Frequency Parameters : &lt; Frequency Parameters IE &gt; &gt; }         { 0   1 &lt; DOWNLINK_TFI_ASSIGNMENT : bit (5) &gt; }         { 0   1 &lt; Power Control Parameters : &lt; Power Control Parameters IE &gt; &gt; }         { 0   1 &lt; TBF Starting Time : &lt; Starting Frame Number Description IE &gt; &gt; }         0 -- The value '1' was allocated in an earlier version of the protocol and shall not be used.         { null   0 bit** = &lt; no string &gt; -- Receiver backward compatible with earlier version             1 -- Additional contents for Release 1999             { 0   1 &lt; EGPRS Window Size : &lt; EGPRS Window Size IE &gt; &gt;               &lt; LINK_QUALITY_MEASUREMENT_MODE : bit (2) &gt;               { 0   1 &lt; BEP_PERIOD2 : bit(4) &gt; } }             { 0   1 &lt; Packet Extended Timing Advance : bit (2) &gt; }             { 0   1 &lt; COMPACT reduced MA : &lt; COMPACT reduced MA IE &gt; &gt; }             { null   0 bit** = &lt; no string &gt; -- Receiver backward compatible with earlier version                 1 -- Additions for REL-5                 { 0   1 &lt; RB Id : bit (5) &gt;                   { 0   1 &lt; G-RNTI extension : bit (4) &gt; }                   { 0   1 &lt; Uplink Control Timeslot : bit (3) &gt; }                   { 0   1 &lt; HFN_LSB : bit (1) &gt; } }                 { null   0 bit** = &lt; no string &gt; -- Receiver backward compatible with earlier version                     1 -- Additions for REL-6                     { 0   1 &lt; PFI : bit (7) &gt; }                     { null   0 bit** = &lt; no string &gt; -- Receiver backward compatible with earlier version                         1 -- Additions for REL-7                         { 0   1 &lt; NPM Transfer Time : bit (5) &gt; }                         { null   0 bit** = &lt; no string &gt; -- Receiver backward compatible with earlier version                             1 -- Additions for REL-9                             &lt; Indication of Upper Layer PDU Start for RLC UM : bit &gt;                             { 0                                 1 &lt; RLC Entity 2 : &lt; RLC Entity Struct &gt; &gt; -- EMST is used                                 { 0                                     1 &lt; RLC Entity 3 : &lt; RLC Entity Struct &gt; &gt; }                               }                             { null   0 bit** = &lt; no string &gt; -- Receiver backward compatible with earlier version                                 1 -- Additions for Rel-10                                 { 1 &lt; EMSR Additional PFCs 1 : &lt; Additional PFCs struct &gt; &gt; } ** 0                                 { 1 &lt; EMSR Additional PFCs 2 : &lt; Additional PFCs struct &gt; &gt; } ** 0                                 { 1 &lt; EMSR Additional PFCs 3 : &lt; Additional PFCs struct &gt; &gt; } ** 0                                 { null   0 bit** = &lt; no string &gt; -- Receiver backward compatible with earlier version                                     1 -- Additions for Rel-12                                     &lt; Primary TSC Set : bit (1) &gt;                                     { 0   1 -- Secondary DL TSC Value assigned                                       &lt; Secondary DL TSC Set : bit (1) &gt;                                       &lt; Secondary DL TSC Value : bit (3) &gt; }                                     &lt; padding bits &gt; } } } } } } // -- truncation at end of message allowed, bits '0'                                 }                                 ! &lt; Non-distribution part error : bit (*) = &lt; no string &gt; &gt; }           }         }       }     }   } } </pre>
--

```

| 1          -- message escape for dual carrier, multi carrier, RTTI, BTTI with FANR activated, EGPRS2
{ 00       -- downlink dual carrier, RTTI, BTTI with FANR activated, EGPRS2
  {
    < RLC_MODE : bit (1) >
    < CONTROL_ACK : bit (1) >
    < Assignment Info : < Assignment Info struct > >
    { 0      -- BTTI mode
      < TIMESLOT_ALLOCATION_C1 : bit (8) >
      { 0 | 1 < TIMESLOT_ALLOCATION_C2 : bit (8) > }
    } | 1    -- RTTI mode
      { 0    -- Single Carrier Assignment
        { 00  -- Default PDCH pair configuration
          | 01  -- Unchanged
          | 10  -- Explicit PDCH pair configuration
          < DOWNLINK_PDCH_PAIRS_C1 : bit (8) >
          < UPLINK_PDCH_PAIRS_C1 : bit (8) >
          ! < PDCH pairs configuration error : { 1 1 } bit (*) = < no string > >    -- reserved
        }
        < RTTI_DOWNLINK_PDCH_PAIR_ASSIGNMENT_SC : bit (4) >
      } | 1  -- Dual Carrier Assignment
        { 00  -- Default PDCH pair configuration
          | 01  -- Unchanged
          | 10  -- Explicit PDCH pair configuration
          < DOWNLINK_PDCH_PAIRS_C1 : bit (8) >
          < DOWNLINK_PDCH_PAIRS_C2 : bit (8) >
          < UPLINK_PDCH_PAIRS_C1 : bit (8) >
          < UPLINK_PDCH_PAIRS_C2 : bit (8) >
          ! < PDCH pairs configuration error : { 1 1 } bit (*) = < no string > >    -- reserved
        }
        < RTTI_DOWNLINK_PDCH_PAIR_ASSIGNMENT_DC : bit (8) >
      }
    }
  }
  < Packet Timing Advance : < Packet Timing Advance IE > >
  { 00  -- No frequency parameters included
    | 01  -- Legacy IEs used
      { 0 | 1 < Frequency Parameters C1 : < Frequency Parameters IE > > }
      { 0 | 1 < Frequency Parameters C2 : < Frequency Parameters IE > > }
    } | 10  -- Optimized Dual Carrier frequency parameters used
      < Dual Carrier Frequency Parameters : < Dual Carrier Frequency Parameters IE > >
      ! < Frequency Parameters error : { 11 } bit(*) = < no string > > -- reserved for future used
      { 0 | 1 < P0_C1 : bit (4) >
        < PR_MODE_C1 : bit (1) >
        { 0 | 1 < P0_C2 : bit (4) >
          < PR_MODE_C2 : bit (1) > } }
      { 0 | 1 < DOWNLINK_TFI_ASSIGNMENT : bit (5) > }
      { 0 | 1 < Power Control Parameters C1 : < Power Control Parameters IE > > }
      { 0 | 1 < Power Control Parameters C2 : < Power Control Parameters IE > > }
      { 0 | 1 < EGPRS Window Size : < EGPRS Window Size IE > >
        < LINK_QUALITY_MEASUREMENT_MODE : bit (2) >
        { 0 | 1 < BEP_PERIOD2 : bit(4) > } }
      { 0 | 1 < Packet Extended Timing Advance : bit (2) > }
      { 0 | 1 < PFI : bit (7) > }
      { 0 | 1 < NPM Transfer Time : bit (5) > }
      { 0 | 1 -- '1' indicates Fast Ack/Nack Reporting is activated
        < EVENT_BASED_FANR : bit (1) >
      }
  }
  < Downlink EGPRS Level : < EGPRS Level IE > >
  { null | 0 bit** = < no string > -- Receiver backward compatible with earlier version

```



```

| 1 -- Additions for REL-9
  < Indication of Upper Layer PDU Start for RLC UM: bit >
  { 0
  | 1 < RLC Entity 2 : < RLC Entity Struct > > -- EMST is used
    { 0
    | 1 < RLC Entity 3 : < RLC Entity Struct > >
    }
  }
  { 0 | 1 MTTI_DOWNLINK_ASSIGNMENT_C1 : bit (1) }
  { 0 | 1 MTTI_DOWNLINK_ASSIGNMENT_C2 : bit (1) }
  { null | 0 bit** = < no string > -- Receiver backward compatible with earlier version
  | 1 -- Additions for Rel-10
    { 1 < EMSR Additional PFCs 1 : < Additional PFCs struct > > } ** 0
    { 1 < EMSR Additional PFCs 2 : < Additional PFCs struct > > } ** 0
    { 1 < EMSR Additional PFCs 3 : < Additional PFCs struct > > } ** 0
    { null | 0 bit** = < no string > -- Receiver backward compatible with earlier version
    | 1 -- Additions for Rel-11
      < EGPRS Packet Downlink Ack/Nack Type 3 Support : bit(1) >
      { null | 0 bit** = < no string > -- Receiver backward compatible with earlier version
      | 1 -- Additions for Rel-12
        < Primary TSC Set : bit (1) >
        { 0 | 1 -- Secondary DL TSC Value assigned
        < Secondary DL TSC Set : bit (1) >
        < Secondary DL TSC Value : bit (3) >
        < padding bits > } } // -- truncation at end of message allowed, bits '0' assumed
      ! < Non-distribution part error : bit (*) = < no string > >
    }
  | 01 -- downlink multi carrier, RTTI, BTTI with FANR activated, EGPRS2
    {
      < RLC_MODE : bit (1) >
      < CONTROL_ACK : bit (1) >
      { 1 < UFPS : < UFPS struct > > } ** 0
      DLMC Measurement Type : bit (1)
      < LINK_QUALITY_MEASUREMENT_MODE : bit (2) >
      { 0 | 1 < Carrier for < Packet Timing Advance : < Packet Timing Advance IE > >
      | 0 | 1 < Packet Extended Timing Advance : bit (2) >
      | 0 | 1 < PTCCH_CARRIER : bit (4) >
      < PDAN Coding : bit (1) >
      < Extended SNS : bit (1) >
      { 0 | 1 < BEP_PERIOD2 : bit(4) >
      | 0 | 1 < PFI : bit (7) >
      | 0 | 1 < NPM Transfer Time : bit (5) >
      | 0 | 1 -- '1' indicates Fast Ack/Nack Reporting is activated
      < EVENT_BASED_FANR: bit (1) >
      < Downlink EGPRS Level: < EGPRS Level IE > >
      < Indication of Upper Layer PDU Start for RLC UM : bit >
      < EGPRS Packet Downlink Ack/Nack Type 3 Support : bit(1) >
      < padding bits > // -- truncation at end of message allowed, bits '0' assumed
      ! < Non-distribution part error : bit (*) = < no string > >
    }
  }
  ! < Message escape : { 10 | 11 } bit (*) = < no string > >
}
! < Address information part error : bit (*) = < no string > >
! < Distribution part error : bit (*) = < no string > >;

< Assignment Info struct > ::=
  < Assignment Type : bit (2) >
  < Carrier ID : bit (1) >;

< RLC Entity Struct > ::=
  < DOWNLINK_TFI_ASSIGNMENT : bit (5) >
  < RLC_MODE : bit (1) >
  { 0 | 1 < EGPRS Window Size : < EGPRS Window Size IE > >
  < PFI : bit (7) >;

< Additional PFCs struct > ::=
  < DOWNLINK_TFI_ASSIGNMENT : bit (5) >
  { 0 | 1 < NPM Transfer Time : bit (5) >
  < PFI : bit (7) >;

```

```

< UFPS struct > ::=
{ 00      -- Existing UFPS released
  | 01      -- Existing UFPS remains unchanged (no information provided)
  | 10      -- Existing UFPS changed/new UFPS provided
    { 0      -- Existing DLMC Frequency Parameters unchanged
      | 1 < DLMC Frequency Parameters : < DLMC Frequency Parameters IE > > }
    { 1 < CARRIER_SPECIFIC_INFO : < Carrier Specific Info struct > > } ** 0
  | 11 bit (*) = < no string >      -- Reserved
};

< Carrier Specific Info struct > ::=
{ 00      -- Existing carrier released
  | 01      -- Existing carrier remains unchanged (no information provided)
  | 10      -- Existing carrier changed/new carrier provided
    { 0      -- BTTI mode
      { 0      -- same timeslots as the lowest numbered carrier
        | 1 < TIMESLOT_ALLOCATION : bit (8) > }
      | 1      -- RTTI mode
        { 0      -- same PDCH-pairs as the lowest numbered carrier
          | 1 < DOWNLINK_PDCH_PAIRS_DLMC : bit (8) >
            < RTTI_DOWNLINK_PDCH_PAIR_ASSIGNMENT_DLMC : bit (4) > }
        }
      { 0 | 1 < MAIO : bit (6) > }
      { 0      -- same P0 and PR_MODE as the lowest numbered carrier
        | 1 < P0 : bit (4) >
          < PR_MODE : bit (1) > }
      { 0      -- same DOWNLINK_TFI_ASSIGNMENT as the lowest numbered carrier
        | 1 < DOWNLINK_TFI_ASSIGNMENT : bit (5) >
          { 0 | 1 < DOWNLINK_eTFI_ASSIGNMENT : bit (3) > } }
      { 0      -- same Power Control Parameters as the lowest numbered carrier
        | 1 < Power Control Parameters : < Power Control Parameters IE > > }
      { 0      -- EMST is not used on this carrier
        | 1 -- EMST is used on this carrier
          < RLC Entity 2 : < RLC Entity Struct > >
          { 0 | 1 < DOWNLINK_eTFI_ASSIGNMENT : bit (3) > }
          { 0 | 1 < RLC Entity 3 : < RLC Entity Struct > >
            { 0 | 1 < DOWNLINK_eTFI_ASSIGNMENT : bit (3) > } }
      { 0      -- EMSR is not used on this carrier
        | 1 -- EMSR is used on this carrier
          { 1 < EMSR Additional PFCs 1 : < Additional PFCs struct > >
            { 0 | 1 < DOWNLINK_eTFI_ASSIGNMENT : bit (3) > } } ** 0
          { 1 < EMSR Additional PFCs 2 : < Additional PFCs struct > >
            { 0 | 1 < DOWNLINK_eTFI_ASSIGNMENT : bit (3) > } } ** 0
          { 1 < EMSR Additional PFCs 3 : < Additional PFCs struct > >
            { 0 | 1 < DOWNLINK_eTFI_ASSIGNMENT : bit (3) > } } ** 0
          }
      < Primary TSC Set : bit (1) >
      { 0 | 1      -- Secondary DL TSC Value assigned
        < Secondary DL SC Set : bit (1) >
        < Secondary DL TSC Value : bit (3) > }
    | 11 bit (*) = < no string >      -- Reserved
};

```

Table 11.2.7.2: PACKET DOWNLINK ASSIGNMENT information element details

**PAGE\_MODE** (2 bit field)

This field is defined in sub-clause 12.20.

**PERSISTENCE\_LEVEL** (4 bit field for each Radio Priority 1...4)

This field is defined in sub-clause 12.14, PRACH Control Parameters.

**Global TFI**

This information element contains the TFI of one of the mobile station's downlink TBFs or uplink TBFs. This field is defined in sub-clause 12.10.

<p><b>TLLI/ G-RNTI</b> (32 bit field) This field is defined in sub-clause 12.16.</p>
<p><b>MAC_MODE</b> (2 bit field) This information field was used in an earlier version of the protocol to indicate the medium access method to be used during an uplink TBF. For backward compatibility reasons, if there is an ongoing uplink TBF using the extended dynamic allocation, the network shall set the value of this field to "extended dynamic allocation". Otherwise, the value shall be set to "dynamic allocation". The mobile station shall ignore this field.</p> <p>bit 2 1</p> <p>0 0 Dynamic Allocation 0 1 Extended Dynamic Allocation 1 0 Reserved -- The value '10' was allocated in an earlier version of the protocol and shall not be used. 1 1 Reserved -- The value '11' was allocated in an earlier version of the protocol and shall not be used.</p>
<p><b>RLC_MODE</b> (1 bit field) This field indicates the RLC mode of the requested TBF. If EMST is used, this field indicates the RLC mode of the RLC entity..</p> <p>0 RLC acknowledged mode 1 RLC unacknowledged mode. For the case of an EGPRS TBF an MS that supports RLC non-persistent mode shall respond to this indication of RLC mode as described in the EGPRS Window Size IE (see sub-clause 12.5.2).</p>
<p><b>CONTROL_ACK</b> (1 bit field) In <i>A/Gb mode</i>, this field shall be set to '1' if the network establishes a new downlink TBF for the mobile station whose timer T3192 is running. Otherwise this field shall be set to '0'.</p> <p>In <i>Iu mode</i>, this field shall be set to '1' if the network wishes to instruct the mobile station to release a given TBF for which timer T3192 is running. The TBF to be released is identified by the TFI given in the DOWNLINK_TFI_ASSIGNMENT field and has to be valid on the PACCH on which this message was sent. Otherwise this field shall be set to '0'.</p>
<p><b>TIMESLOT_ALLOCATION</b> (8 bit field) This field is defined in sub-clause 12.18.</p> <p><b>TIMESLOT_ALLOCATION_C1, TIMESLOT_ALLOCATION_C2</b> (8 bit field) These information fields indicate the timeslots assigned for use during the TBF. If the Assignment Type field is included and indicates 'Assignment on single carrier only' or 'Modification of existing assignment', then TIMESLOT_ALLOCATION_C1 shall apply to the carrier indicated by the Carrier ID field. Otherwise, TIMESLOT_ALLOCATION_C1 and TIMESLOT_ALLOCATION_C2 shall apply on carrier 1 and carrier 2 respectively of a dual carrier configuration. These fields are defined in sub-clause 12.18.</p> <p>If TIMESLOT_ALLOCATION_C1 is present and TIMESLOT_ALLOCATION_C2 is not present and the Assignment Type field indicates 'Dual Carrier assignment', then the timeslots specified in TIMESLOT_ALLOCATION_C1 apply also to carrier 2.</p> <p>For the case of a downlink carrier assigned for a DLMC configuration the assignment message shall provide the TIMESLOT_ALLOCATION IE for at least the first carrier in the corresponding UFPS. If this IE is absent for any remaining carriers, the TIMESLOT_ALLOCATION IE for the lowest numbered carrier (see sub-clause 8.1.1.1.3) shall apply.</p> <p><b>Packet Timing Advance</b> This information element is defined in sub-clause 12.12.</p>

**P0, P0\_C1, P0\_C2** (4 bit field)

For description and encoding, see the Packet Uplink Assignment message. If the Assignment Type field is included and indicates 'Assignment on single carrier only' or 'Modification of existing assignment', then P0\_C1 shall apply to the carrier indicated by the Carrier ID field. Otherwise, P0\_C1 and P0\_C2 shall apply to carrier 1 and carrier 2 respectively. If the P0\_C1 IE is present but the P0\_C2 IE is absent and the Assignment Type field indicates 'Dual Carrier assignment', then the P0\_C1 IE shall apply also to carrier 2.

For the case of a downlink carrier assigned for a DLMC configuration the assignment message shall provide the P0 IE for at least the first carrier in the corresponding UFPS. If this IE is absent for any remaining carriers, the P0 IE for the lowest numbered carrier (see sub-clause 8.1.1.1.3) shall apply.

**PR\_MODE, PR\_MODE\_C1, PR\_MODE\_C2** (1 bit field)

For description and encoding, see the Packet Uplink Assignment message. If the Assignment Type field is included and indicates 'Assignment on single carrier only' or 'Modification of existing assignment', then PR\_MODE\_C1 shall apply to the carrier specified in the Carrier ID field. Otherwise, PR\_MODE\_C1 and PR\_MODE\_C2 shall apply to carrier 1 and carrier 2 respectively. If the Assignment Type field indicates 'Dual Carrier assignment' and the PR\_MODE\_C1 IE is present but the PR\_MODE\_C2 IE is absent, then the PR\_MODE\_C1 IE shall apply also to carrier 2.

For the case of a downlink carrier assigned for a DLMC configuration the assignment message shall provide the PR\_MODE IE for at least the first carrier in the corresponding UFPS. If this IE is absent for any remaining carriers, the PR\_MODE IE for the lowest numbered carrier (see sub-clause 8.1.1.1.3) shall apply.

**Power Control Parameters, Power Control Parameters C1, Power Control Parameters C2**

These information elements are coded as defined in sub-clause 12.13.

If the Assignment Type field is included and indicates 'Assignment on single carrier only' or 'Modification of existing assignment', then the Power Control Parameters C1 IE shall apply to the carrier specified in the Carrier ID field. If, in this case, the Power Control Parameters C1 IE is absent, then the previous parameters for that carrier shall apply.

If the Assignment Type field is included and indicates 'Dual Carrier assignment' and the Power Control Parameters C1 IE is present but the Power Control Parameters C2 IE is absent, then the Power Control Parameters C1 IE shall apply also to carrier 2. Otherwise, if either Power Control Parameters C1 IE or Power Control Parameters C2 IE is absent, the previous parameters for the respective carrier(s) shall apply.

For the case of a downlink carrier assigned for a DLMC configuration the assignment message shall provide the Power Control Parameters IE for at least the first carrier in the corresponding UFPS. If this IE is absent for any remaining carriers, the Power Control Parameters IE for the lowest numbered carrier (see sub-clause 8.1.1.1.3) shall apply.

**Frequency Parameters**

This information element is defined in sub-clause 12.8.

**Frequency Parameters C1, Frequency Parameters C2**

These information elements are coded as defined in sub-clause 12.8.

If the Assignment Type field is included and indicates 'Assignment on single carrier only' or 'Modification of existing assignment', then Frequency Parameters C1 (if present) shall apply to the carrier specified in the Carrier ID field.

If the Assignment Type field is included and indicates 'Dual Carrier assignment', Frequency Parameters C1 and Frequency Parameters C2 (if present) assign frequency parameters for carrier 1 and carrier 2, respectively.

**Dual Carrier Frequency Parameters**

This information element is defined in sub-clause 12.8.2.

**DOWNLINK\_TFI\_ASSIGNMENT** (5 bit field)

This information element, if present, assigns the TFI to the mobile station to identify the downlink TBF described by this message. TFI is encoded as defined in sub-clause 12.15. If EMST is used, each TFI identifies an RLC entity allocated on the downlink TBF. If EMSR is supported, each TFI identifies a Packet Flow Context supported by a specific RLC entity allocated on the downlink TBF.

If a DL MC configuration is established, the assignment message shall provide the DOWNLINK\_TFI\_ASSIGNMENT IE for at least the first carrier in the corresponding UFPS. If this IE is absent for any remaining carriers, the DOWNLINK\_TFI\_ASSIGNMENT IE for the first carrier in the first UFPS shall apply.

**TBF Starting Time**

The TBF Starting Time field contains a starting time that indicates the TDMA frame number during which the assigned TBF may start. If no downlink TBF is in progress, the mobile station need not monitor the TFI field of downlink RLC data blocks until the indicated TDMA frame number. After the indicated TDMA frame number, the mobile station shall operate as during a downlink TBF. If a downlink TBF is already in progress, the mobile station shall continue to use the parameters of the existing TBF until the TDMA frame number occurs. When the indicated TDMA frame number occurs, the mobile station shall immediately begin to use the new parameters assigned. This information element is defined in sub-clause 12.21.

**EGPRS Window Size**

This information element is defined in sub-clause 12.5.2.

**LINK\_QUALITY\_MEASUREMENT\_MODE** (2 bit field)

This field determines the measurements to be included within the EGPRS Timeslot Link Quality Measurements IE or EGPRS Timeslot Link Quality Measurements Type 2 IE. In case the assignment results in a dual carrier configuration, the value of the LINK\_QUALITY\_MEASUREMENT\_MODE field shall apply to both carriers. In case the assignment results in a DLMC configuration, the value of the LINK\_QUALITY\_MEASUREMENT\_MODE field shall apply to all carriers.

bit

2 1

- 0 0 The mobile station shall not report either interference measurements ( $\gamma$  values) or per slot (slot pair in RTTI configuration) mean BEP measurements.
- 0 1 The mobile station shall report available interference measurements ( $\gamma$  values) for timeslots 0 through 7. The  $\gamma$  value is defined in 3GPP TS 45.008. No per slot (slot pair in RTTI configuration) mean BEP measurements shall be reported.

For a mobile station in a DLMC configuration, available interference measurements shall be reported for timeslots 0 through 7 for the carrier indicated by the assignment message or the lowest numbered downlink carrier if carrier information for interference measurements is not provided by the assignment message (see sub-clause 12.66 for additional reporting rules).

- 1 0 The mobile station shall report the mean BEP on each assigned time slot (slot pair in RTTI configuration) as specified in 3GPP TS 45.008. No interference measurements ( $\gamma$  values) shall be reported. For a mobile station in a DLMC configuration where measurement information is to be reported on a per carrier basis (see sub-clause 11.2.7), the mean BEP (as specified in 3GPP TS 45.008) shall only be reported for the assigned timeslots on the carrier on which it was polled (see sub-clause 12.66). A mobile station in a DLMC configuration where measurement information is to be reported on a per UFPS basis (see sub-clause 9.1.8.2.1) shall treat this code point as the "00" code point.
- 1 1 The mobile station shall report the mean BEP on each assigned time slot (slot pair in RTTI configuration) as specified in 3GPP TS 45.008. In addition to mean BEP, the mobile station shall report interference measurements ( $\gamma$  values) for no more than four time slots for a given carrier within a single reporting message instance. If the MS has interference measurements for more than four timeslots to report for a given carrier, the selection of timeslots for which interference measurements are included in each message instance is implementation specific, subject to the requirement that a measurement for each time slot on each carrier, unless not available (see 3GPP TS 45.008), is included in at least every other report.

For a mobile station in a DLMC configuration, available interference measurements shall be reported for timeslots 0 through 7 for the carrier indicated by the assignment message or the lowest numbered downlink carrier if carrier information for interference measurements is not provided by the assignment message (see sub-clause 12.66 for additional reporting rules). If measurement information is to be reported on a per carrier basis (see sub-clause 11.2.7), the mean BEP (as specified in 3GPP TS 45.008) shall only be reported for the assigned timeslots on the carrier on which it was polled (see sub-clause 12.66). A mobile station in a DLMC configuration where measurement information is to be reported on a per UFPS basis (see sub-clause 9.1.8.2.1) shall treat this code point as the "01" code point.

In addition, for a mobile station assigned a Downlink Dual Carrier configuration, if not all the required interference measurements can be included within a reporting message instance after all the required per slot mean BEP values for both carriers have been included, the mobile station shall include as many interference measurements (if any) as can fit in this message instance. The selection of timeslots for which interference measurements are included in each message instance is implementation specific. See sub-clause 9.1.8.2.1 for how a mobile station in a DLMC configuration can report information for more than one UFPS/carrier.

**Packet Extended Timing Advance** (2 bit field)

This field is defined in sub-clause 12.12b.

**COMPACT reduced MA**

This information element is defined in sub-clause 12.29.

<p><b>BEP_PERIOD2</b> (4 bit field)</p> <p>This field contains a constant which is used for filtering channel quality measurements in EGPRS. BEP_PERIOD2 when present, or if not, when received in a previous message of the same TBF session, shall be used instead of BEP_PERIOD. For details see 3GPP TS 45.008.</p> <p>Range: 0 to 15</p>												
<p><b>RB Id</b> (5 bit field)</p> <p>This field is included in <i>Iu</i> mode when a TBF is assigned. It contains the radio bearer identifier for the radio bearer using the assigned TBF.</p>												
<p><b>G-RNTI extension</b> (4 bit field)</p> <p>This field contains the extra 4 bits of the G-RNTI not included in the TLLI / G-RNTI field which are necessary to provide a unique identifier for contention resolution in <i>Iu</i>-mode.</p>												
<p><b>Uplink Control Timeslot</b> (3 bit field)</p> <p>This field contains the timeslot number of the timeslot where the PACCH for the MS is located. It is encoded as the binary representation of the timeslot number as defined in 3GPP TS 45.002.</p>												
<p><b>HFN_LSB</b> (1 bit field)</p> <p>This field contains the least significant bit of the downlink HFN of the radio bearer for which the TBF is assigned. It is used in <i>Iu mode</i> only.</p>												
<p><b>PFI</b> (7 bit field)</p> <p>This field contains the PFI parameter identifying the Packet Flow Context related to the TBF identified in the DOWNLINK_TFI_ASSIGNMENT field. The PFI parameter is encoded as the contents of the PFI information element defined in 3GPP TS 44.018. If EMST is used, this field contains the PFI parameter identifying the Packet Flow Context related to the RLC entity. If EMSR is supported, this field contains the PFI parameter identifying a Packet Flow Context supported by a specific RLC entity.</p>												
<p><b>NPM Transfer Time</b> (5 bit field)</p> <p>This field contains the NPM Transfer Time limitation for TBF or RLC entity assigned to operate in RLC non-persistent mode. If EMSR is supported this field contains the NPM Transfer Time limitation for a specific Packet Flow Context configured to use RLC non-persistent mode.</p>												
<p><b>Assignment Type</b> (2 bit field)</p> <p>This indicates the type of assignment:</p> <table> <tr> <td>bit</td> <td></td> </tr> <tr> <td>2 1</td> <td></td> </tr> <tr> <td>0 0</td> <td>Assignment on single carrier only</td> </tr> <tr> <td>0 1</td> <td>Modification of existing assignment</td> </tr> <tr> <td>1 0</td> <td>Dual Carrier assignment</td> </tr> <tr> <td>1 1</td> <td>Reserved for future use</td> </tr> </table> <p>If the Assignment Type indicates an Assignment on a single carrier only the resources specified in this message are assigned for this TBF on the carrier identified by the Carrier ID field. If the assignment is sent to a mobile station that does not currently have a dual carrier configuration, the Carrier ID field shall indicate Carrier 1 and all resources specified in the message shall relate to Carrier 1.</p> <p>If the Assignment Type indicates Modification of an existing assignment resources specified in this message replace any existing allocation for this TBF on the carrier indicated by the Carrier ID field. If this type of assignment is used to place a mobile station which currently has resources assigned on only one carrier in a dual carrier configuration the Carrier ID shall indicate Carrier 2.</p> <p>If the Assignment Type indicates a Dual Carrier assignment the Carrier ID field shall be ignored by the mobile station.</p> <p>The meaning of the different types of assignment is specified in sub-clause 8.1.1.1.3.</p>	bit		2 1		0 0	Assignment on single carrier only	0 1	Modification of existing assignment	1 0	Dual Carrier assignment	1 1	Reserved for future use
bit												
2 1												
0 0	Assignment on single carrier only											
0 1	Modification of existing assignment											
1 0	Dual Carrier assignment											
1 1	Reserved for future use											

<p><b>Carrier ID</b> (1 bit field) This identifies the carrier to which the description refers.</p> <p>0 Carrier 1 1 Carrier 2</p>
<p><b>EVENT_BASED_FANR</b> (1 bit field) This field indicates whether the event-based FANR shall be used for the assigned TBF. This field shall be included if the assignment is for a RTTI or MTTI configuration.</p> <p>0 The MS shall not use event-based FANR 1 The MS shall use event-based FANR</p>
<p><b>DOWNLINK_PDCH_PAIRS_C1</b> <b>DOWNLINK_PDCH_PAIRS_C2</b> <b>UPLINK_PDCH_PAIRS_C1</b> <b>UPLINK_PDCH_PAIRS_C2</b> <b>RTTI_DOWNLINK_PDCH_PAIR_ASSIGNMENT_SC</b> <b>RTTI_DOWNLINK_PDCH_PAIR_ASSIGNMENT_DC</b> <b>DOWNLINK_PDCH_PAIRS_DLMC</b> <b>UPLINK_PDCH_PAIRS_DLMC</b> <b>RTTI_DOWNLINK_PDCH_PAIR_ASSIGNMENT_DLMC</b></p> <p>These fields are defined in sub-clause 11.2.31</p>
<p><b>Downlink EGPRS Level</b> (2 bit field) This information element specifies the group of modulation and coding schemes applicable to the TBF. This information element is defined in sub-clause 12.10f.</p>
<p><b>Indication of Upper Layer PDU Start for RLC UM</b> (1 bit field) This field indicates whether "Indication of Upper Layer PDU Start for RLC UM" as described in sub-clause 10.4.14a is used for the assigned TBF. It is applicable only when the assigned TBF is operating in RLC unacknowledged mode.</p> <p>0 "Indication of Upper Layer PDU Start for RLC UM" is not used for the assigned TBF. 1 "Indication of Upper Layer PDU Start for RLC UM" is used for the assigned TBF.</p>
<p><b>MTTI_DOWNLINK_ASSIGNMENT_C1</b> (1 bit field) <b>MTTI_DOWNLINK_ASSIGNMENT_C2</b> (1 bit field)</p> <p>If either of these fields is present, it indicates that the assigned downlink TBF operates in an MTTI configuration. If present, a PDCH is assigned on the respective carrier in addition to any assigned PDCH-pairs. If set to '1' (respectively '0'), the assigned PDCH uses the timeslot immediately adjacent to and lower than (respectively higher than) the lower (respectively higher) timeslot used by the lowest numbered (respectively highest numbered) PDCH-pair assigned on that carrier. If no PDCH-pairs are assigned on one carrier, then the assigned PDCH for that carrier is on the same timeslot as the assigned PDCH on the other carrier, regardless of the value of the field.</p>
<p><b>EMSR Additional PFCs 1</b> <b>EMSR Additional PFCs 2</b> <b>EMSR Additional PFCs 3</b></p> <p>If EMSR is supported one or more of these information elements may be included for allocating multiple PFCs to their corresponding RLC entity:</p> <ul style="list-style-type: none"> <li>- if EMST is not used, <b>EMSR Additional PFCs 1</b> corresponds to the single RLC entity of the TBF; <b>EMSR Additional PFCs 2</b> and <b>EMSR Additional PFCs 3</b>, if present, shall be ignored.</li> <li>- if EMST is used, <b>EMSR Additional PFCs 1</b>, <b>EMSR Additional PFCs 2</b> and <b>EMSR Additional PFCs 3</b> correspond to the first, the second and the third RLC entity, respectively, assigned to the TBF. <b>EMSR Additional PFCs 2</b> corresponds to the RLC entity assigned using the <b>RLC Entity 2</b> IE and <b>EMSR Additional PFCs 3</b> correspond to the RLC entity assigned using the <b>RLC Entity 3</b> IE if these RLC entities have been assigned; <b>EMSR Additional PFCs 2</b>, respectively <b>EMSR Additional PFCs 3</b>, if present, shall be ignored if the corresponding RLC entity has not been assigned.</li> </ul>
<p><b>EGPRS Packet Downlink Ack/Nack Type 3 Support</b> (1 bit field) This field indicates whether or not the network supports the EGPRS PACKET DOWNLINK ACK/NACK TYPE 3 message (see sub-clause 11.2.6f):</p> <p>0 The network does not support the EGPRS PACKET DOWNLINK ACK/NACK TYPE 3 message. 1 The network supports the EGPRS PACKET DOWNLINK ACK/NACK TYPE 3 message.</p> <p>If this field is not present, the value '0' (EGPRS PACKET DOWNLINK ACK/NACK TYPE 3 message not supported) shall be assumed by the mobile station.</p>



**UFPS**

This information element is used to identify the set of resources corresponding to each UFPS within the set of UFPS assigned for a DLMC configuration. Each UFPS in the set of UFPS is numbered according to the scheme described in sub-clause 8.1.1.1.3. The assignment message allows for releasing an existing UFPS, keeping an existing UFPS unchanged, modifying an existing UFPS or adding a new UFPS.

For the case where a UFPS is defined by a MA the first frequency indicated for the UFPS (i.e. by the CARRIER\_SPECIFIC\_INFO IE) is that corresponding to highest numbered element of the MA\_BITMAP for which a "1" is indicated, the second frequency indicated is that corresponding to 2<sup>nd</sup> highest numbered element of the MA\_BITMAP for which a "1" is indicated, and so on where the last frequency indicated is that corresponding to lowest numbered element of the MA\_BITMAP for which a "1" is indicated. See sub-clause 12.10a for a description of the MA\_BITMAP field.

**DLMC Measurement Type**

This field indicates the type of measurement reporting to be used by a mobile station in a DLMC configuration.

bit

- 0 BEP Link Quality is reported on a per UFPS basis using a representative value averaged over all carriers in the reported UFPS (see 3GPP TS 45.008 [15]).
- 1 BEP Link Quality is reported on a per carrier basis.

This field indicates the carrier to be used for making interference measurements. If the

**LINK\_QUALITY\_MEASUREMENT\_MODE** field indicates interference measurements are requested and this field is absent the MS shall make interference measurements using the lowest numbered carrier (see sub-clause 8.1.1.1.3).

bit

- |         |                                  |
|---------|----------------------------------|
| 4 3 2 1 |                                  |
| 0 0 0 0 | Use the 1 <sup>st</sup> carrier  |
| 0 0 0 1 | Use the 2 <sup>nd</sup> carrier  |
| 0 0 1 0 | Use the 3 <sup>rd</sup> carrier  |
| ...     |                                  |
| 1 1 1 0 | Use the 15 <sup>th</sup> carrier |
| 1 1 1 1 | Use the 16 <sup>th</sup> carrier |

**CARRIER\_SPECIFIC\_INFO**

This information element is used to describe the downlink carriers corresponding to a given UFPS applicable to the downlink TBF assigned for a DLMC configuration (see sub-clause 8.1.1.1.3 for the numbering of downlink carriers in a DLMC configuration).

**DLMC Frequency Parameters**

This information element provides frequency parameters for a UFPS and is described in sub-clause 12.8.4. For the case where a UFPS is defined by an MA this information element indicates the corresponding mobile allocation and TSC applicable to all carriers in that UFPS.

**MAIO** (6 bit field)

This field is the binary representation of the mobile allocation index offset (MAIO), see 3GPP TS 45.002. Range 0 to 63.

**PTCCH\_CARRIER** (4 bit field)

This field is included if the continuous timing advance procedure is used and identifies the carrier that serves as the PTCCH carrier.

**PDAN Coding** (1 bit field)

This information field indicates the channel coding rate to be used when a mobile station in a DLMC configuration sends a Packet Downlink Ack/Nack message and is coded as follows:

- 0 CS-1 channel coding is used
- 1 CS-3 channel coding is used

**DOWNLINK\_eTFI\_ASSIGNMENT** (3 bit field)

This field, if present, assigns an extended TFI (eTFI) used by a mobile station in a DL MC configuration that along with the TFI uniquely identifies a downlink Temporary Block Flow (TBF) on a given carrier (see sub-clause 5.13). This information element is encoded as defined in sub-clause 12.67. When this field is present, the assignment message shall provide it for at least the first carrier in the corresponding UFPS. If this field is absent for any remaining carriers, the DOWNLINK\_eTFI\_ASSIGNMENT IE for the lowest numbered carrier (see sub-clause 8.1.1.3) shall apply

**Extended SNS** (1 bit field)

This field indicates whether or not the Extended Sequence Number Space of 8192 shall be used in a DL MC configuration. A mobile station shall ignore this field if the maximum number of downlink timeslots it supports in a DL MC configuration is 20 or less.

- 0 Extended SNS is disabled
- 1 Extended SNS is enabled

**Primary TSC Set** (1 bit field)

If a mobile station supports the extended TSC sets (see 3GPP TS 45.002 [32]) then it shall use this field to identify the TSC set associated with the TSC value provided by the *Frequency Parameters* IE, *Dual Carrier Frequency Parameters* IE or *DL MC Frequency Parameters* IE for use on the assigned downlink PS resources.

**Secondary DL TSC Set** (1 bit field)

If a mobile station supports the extended TSC sets (see 3GPP TS 45.002 [32]) then it shall use this field to identify the TSC set associated with the *Secondary DL TSC Value* field.

The Primary TSC Set and Secondary DL TSC Set fields are coded as follows:

- 0 TSC set 1
- 1 Indicates TSC set 2 for 8PSK, 16QAM and 32QAM modulation. For GMSK modulation it indicates TSC set 3 (which is identical to TSC set 3 used for the CS domain).

**Secondary DL TSC Value** (3 bit field)

If a mobile station supports the extended TSC sets (see 3GPP TS 45.002 [32]) then it shall use this field to identify the secondary TSC value to be used on the assigned downlink PS resources. It is coded as the binary representation of the Training Sequence code as defined in 3GPP TS 45.002. Range: 0 to 7.

### 11.2.7.1 Special requirements in dual transfer mode for downlink TBF

Special requirements apply when a downlink TBF is assigned to a mobile station in dual transfer mode or a mobile station about to enter dual transfer mode.

If the mobile station has an RR connection to the network on a half-rate TCH, the network may assign a downlink TBF using the other sub-channel of the same timeslot for a half-rate PDCH (see 3GPP TS 45.002). In this case, the downlink assignment message shall be encoded with a timeslot allocation including the timeslot number for the half-rate TCH and the half-rate PDCH and only that timeslot number. The mobile station shall interpret this allocation as an allocation of a half-rate PDCH.

### 11.2.7a Multiple TBF Downlink Assignment

This message is sent on the PACCH by the network to the mobile station to assign multiple downlink resources to the mobile station. If the mobile station supports Downlink Dual Carrier, this message may be sent using extended RLC/MAC control message segmentation (see sub-clause 9.1.12a).

A mobile allocation or reference frequency list received as part of this assignment message shall be valid until a new assignment is received or until all of the TBFs belonging to the MS are terminated.

Message type: MULTIPLE TBF DOWNLINK ASSIGNMENT

Direction: network to mobile station

Classification: non-distribution message

Table 11.2.7a.1: MULTIPLE TBF DOWNLINK ASSIGNMENT information elements

```

< Multiple TBF Downlink Assignment message content > ::=
< PAGE_MODE : bit (2) >
{ 0 | 1 < PERSISTENCE_LEVEL : bit (4) > * 4 }
{
  { 0 < Global TFI : < Global TFI IE > >
    | 10 { < TLLI / G-RNTI : < TLLI / G-RNTI IE > > < G-RNTI extension : bit (4) > } }
    | 0 -- Message escape
      { < Packet Timing Advance : < Packet Timing Advance IE > >
        { 0 | 1 < P0 : bit (4) >
          < PR_MODE : bit (1) > }
          { { 0 | 1 < Frequency Parameters : < Frequency Parameters IE > > }
            { 0 | 1 < Power Control Parameters : < Power Control Parameters IE > > }
            { 0 | 1 < TBF Starting Time : < Starting Frame Number Description IE > > }
            { 0 | 1 { 0 | 1 < EGPRS Window Size : < EGPRS Window Size IE > > }
              < LINK_QUALITY_MEASUREMENT_MODE : bit (2) >
              { 0 | 1 < BEP_PERIOD2 : bit(4) > } }
            { 0 | 1 < Packet Extended Timing Advance : bit (2) > }
            { 0 | 1 < Uplink Control Timeslot : bit (3) > }
            { 1 < Multiple Downlink TBF Assignment : < Multiple Downlink TBF Assignment struct > > } ** 0
              { null | 0 bit** = < no string > -- Receiver backward compatible with earlier version
                | 1 -- Additions for REL-7
                  { 1 { 0 | 1 < NPM Transfer Time : bit (5) > } ** 0
                    < padding bits > } } // -- truncation at end of message allowed, bits '0' assumed
              ! < Non-distribution part error : bit (*) = < no string > > }

```

```

| 1 -- Message escape for dual carrier, RTTI, BTTI with FANR activated, EGPRS2
{ 00 { < Packet Timing Advance : < Packet Timing Advance IE > >
  < Assignment Info : < Assignment Info struct > >
  { 0 | 1 < P0_C1 : bit (4) >
    < PR_MODE_C1 : bit (1) >
    { 0 | 1 < P0_C2 : bit (4) >
      < PR_MODE_C2 : bit (1) > } }
  { { 00 -- No frequency parameters included
    | 01 -- Legacy IEs used
      { 0 | 1 < Frequency Parameters C1 : < Frequency Parameters IE > > }
      { 0 | 1 < Frequency Parameters C2 : < Frequency Parameters IE > > }
    | 10 -- Optimized Dual Carrier frequency parameters used
      < Dual Carrier Frequency Parameters: < Dual Carrier Frequency Parameters IE > >
      ! < Frequency Parameters error: { 11 } bit(*) = < no string > > -- reserved for future use
      { 0 | 1 < Power Control Parameters C1 : < Power Control Parameters IE > > }
      { 0 | 1 < Power Control Parameters C2 : < Power Control Parameters IE > > }
      { 0 | 1 { 0 | 1 < EGPRS Window Size : < EGPRS Window Size IE > > }
        < LINK_QUALITY_MEASUREMENT_MODE : bit (2) >
        { 0 | 1 < BEP_PERIOD2 : bit(4) > } }
      { 0 | 1 < Packet Extended Timing Advance : bit (2) > }
      { 0 | 1 < Uplink Control Timeslot C1 : bit (3) > }
      { 0 | 1 < Uplink Control Timeslot C2 : bit (3) > }
      { 0 | 1 -- BTTI mode
        < FANR: bit (1) >
        { 1 < BTTI Multiple Downlink Assignment :
          < BTTI Multiple Downlink Assignment struct > > } ** 0
        }
      { 0 | 1 -- RTTI mode
        { 0
          -- Single Carrier Assignment
          { 00 -- Default PDCH-pair configuration
            | 01 -- Unchanged
            | 10 -- Explicit PDCH pair configuration
              < DOWNLINK_PDCH_PAIRS_C1 : bit (8) >
              < UPLINK_PDCH_PAIRS_C1 : bit (8) >
              ! < PDCH pairs configuration error : { 1 1 } bit (*) = < no string > > -- reserved
            }
          { 1 < RTTI Multiple Downlink Assignment SC :
            < RTTI Multiple Downlink Assignment SC struct > > } ** 0
          | 1 -- Dual Carrier Assignment
          { 00 -- Default PDCH pair configuration
            | 01 -- Unchanged
            | 10 -- Explicit PDCH pair configuration
              < DOWNLINK_PDCH_PAIRS_C1 : bit (8) >
              < DOWNLINK_PDCH_PAIRS_C2 : bit (8) >
              < UPLINK_PDCH_PAIRS_C1 : bit (8) >
              < UPLINK_PDCH_PAIRS_C2 : bit (8) >
              ! < PDCH pairs configuration error : { 1 1 } bit (*) = < no string > > -- reserved
            }
          { 1 < RTTI Multiple Downlink Assignment DC :
            < RTTI Multiple Downlink Assignment DC struct > > } ** 0
          }
        }
      }
    }
  }
  < Downlink EGPRS Level: < EGPRS Level IE > >
  { null | 0 bit** = < no string > -- Receiver backward compatible with earlier version
    | 1 -- Additions for Rel-9
      { 1 < Indication of Upper Layer PDU Start for RLC UM : bit > } ** 0
      < padding bits > } // -- truncation at end of message allowed, bits '0' assumed
      ! < Non-distribution part error : bit (*) = < no string > > }
      ! < Message escape : { 01 | 10 | 11 } bit (*) = < no string > > }
      ! < Address information part error : bit (*) = < no string > > }
      ! < Distribution part error : bit (*) = < no string > > ;
  }
}
< Multiple Downlink TBF Assignment struct > ::=
  < TIMESLOT_ALLOCATION : bit (8) >
  { 1 < Downlink TBF assignment : < Downlink TBF assignment struct > > } ** 0 ;

```

```

< BTTI Multiple Downlink Assignment struct > ::=
  { 0 | 1 < TIMESLOT_ALLOCATION_C1 : bit (8) > }
  { 0 | 1 < TIMESLOT_ALLOCATION_C2 : bit (8) > }
  { 1 < Downlink TBF assignment : < Downlink TBF assignment 2 struct > > } ** 0 ;

< RTTI Multiple Downlink Assignment SC struct > ::=
  < RTTI_DOWNLINK_PDCH_PAIR_ASSIGNMENT_SC : bit (4) >
  { 1 < Downlink TBF assignment : < Downlink TBF assignment 2 struct > > } ** 0 ;

< RTTI Multiple Downlink Assignment DC struct > ::=
  < RTTI_DOWNLINK_PDCH_PAIR_ASSIGNMENT_DC : bit (8) >
  { 1 < Downlink TBF assignment : < Downlink TBF assignment 2 struct > > } ** 0 ;

< Downlink TBF assignment struct > ::=
  { 0 < RB Id : bit (5) >
    | 1 < PFI : bit (7) >
      < RLC_MODE : bit (1) > }
  < TFI Assignment : bit (5) >
  < CONTROL_ACK : bit (1) >
  { 0 | 1 < EGPRS Window Size : < EGPRS Window Size IE > > }
  { 0 | 1 < HFN_LSB : bit (1) > }; -- HFN_LSB field used in lu mode only

< Downlink TBF assignment 2 struct > ::=
  < PFI : bit (7) >
  < RLC_MODE : bit (1) >
  < TFI Assignment : bit (5) >
  < CONTROL_ACK : bit (1) >
  { 0 | 1 < NPM Transfer Time : bit (5) > }
  < EVENT_BASED_FANR : bit (1) >
  { 0 | 1 < Downlink EGPRS Window Size : < EGPRS Window Size IE > > };

< Assignment Info struct > ::=
  < Assignment Type : bit (2) >
  < Carrier ID : bit (1) > ;

```

Table 11.2.7a.2: MULTIPLE TBF DOWNLINK ASSIGNMENT information element details

<b>PAGE_MODE</b> (2 bit field) This field is defined in sub-clause 12.20.
<b>PERSISTENCE_LEVEL</b> (4 bit field for each Radio Priority 1...4) This field is defined in sub-clause 12.14, PRACH Control Parameters.
<b>Global TFI</b> This information element identifies one of the mobile station's downlink or uplink TFIs. This field is defined in sub-clause 12.10.
<b>TLLI / G-RNTI</b> This information element is defined in sub-clause 12.16.
<b>G-RNTI extension</b> (4 bit field) This field contains the extra 4 bits of the G-RNTI not included in the TLLI / G-RNTI field which are necessary to provide a unique identifier for contention resolution in Iu-mode.
<b>CONTROL_ACK</b> (1 bit field) This field shall be set to "1" if the network wishes to instruct the mobile station to release the given TBFs for which timer T3192 is running. The TBFs to be released are identified by the TFIs given in the TFI Assignment field and have to be valid on the PACCH on which this message was sent. Otherwise this field shall be set to "0".
<b>TIMESLOT_ALLOCATION, TIMESLOT_ALLOCATION_C1, TIMESLOT_ALLOCATION_C2</b> (8 bit field) These fields describe the timeslot(s) on which all TBFs described in this message are assigned resources.

<p><b>Uplink Control Timeslot, Uplink Control Timeslot C1, Uplink Control Timeslot C2</b> (3 bit field)</p> <p>In case of a BTTI configuration, these fields contain the timeslot number of the timeslot where the PACCH/U for the MS is located. In case of an RTTI configuration, these fields contain the timeslot number of the timeslot belonging to the uplink PDCH pair where the PACCH/U for the MS is located. These fields are encoded as the binary representation of the timeslot number as defined in 3GPP TS 45.002.</p>
<p><b>Packet Timing Advance</b></p> <p>This information element is defined in sub-clause 12.12.</p>
<p><b>P0, P0_C1, P0_C2</b> (4 bit field)</p> <p>For description and encoding, see the Packet Uplink Assignment message.</p>
<p><b>PR_MODE, PR_MODE_C1, PR_MODE_C2</b> (1 bit field)</p> <p>For description and encoding, see the Packet Uplink Assignment message.</p>
<p><b>Power Control Parameters, Power Control Parameters C1, Power Control Parameters C2</b></p> <p>This information element is defined in sub-clause 12.13.</p>
<p><b>Frequency Parameters</b></p> <p>This information element is defined in sub-clause 12.8.</p> <p><b>Frequency Parameters C1, Frequency Parameters C2</b></p> <p>The usage of these parameters is specified in sub-clause 11.2.7. These information elements are coded as defined in sub-clause 12.8.</p> <p><b>Dual Carrier Frequency Parameters</b></p> <p>This information element is defined in sub-clause 12.8.2</p>
<p><b>TFI Assignment</b> (5 bit field)</p> <p>This information element assigns one (or more) TFI(s) to each TBF assigned to the mobile station in this message. This field is repeated for each TBF that is assigned in this message. TFI is encoded as defined in sub-clause 12.15.</p>
<p><b>TBF Starting Time</b></p> <p>The TBF Starting Time field contains a starting time that indicates the TDMA frame number during which the assigned TBFs may start. If no downlink TBF is in progress, the mobile station need not monitor the TFI field of downlink RLC data blocks until the indicated TDMA frame number. After the indicated TDMA frame number, the mobile station shall operate as during a downlink TBF. If a downlink TBF is already in progress, the mobile station shall continue to use the parameters of the existing TBF until the TDMA frame number occurs. When the indicated TDMA frame number occurs, the mobile station shall immediately begin to use the new parameters assigned. This information element is defined in sub-clause 12.21.</p>
<p><b>EGPRS Window Size</b></p> <p>This information element is defined in sub-clause 12.5.2.</p>
<p><b>LINK_QUALITY_MEASUREMENT_MODE</b> (2 bit field)</p> <p>This field is defined in sub-clause 11.2.7</p>
<p><b>Packet Extended Timing Advance</b> (2 bit field)</p> <p>This field is defined in sub-clause 12.12b.</p>
<p><b>BEP_PERIOD2</b> (4 bit field)</p> <p>This field contains a constant which is used for filtering channel quality measurements in EGPRS. BEP_PERIOD2 when present, or if not, when received in a previous message of the same TBF session, shall be used instead of BEP_PERIOD. For details see 3GPP TS 45.008. Range: 0 to 15</p>
<p><b>RB Id</b> (5 bit field)</p> <p>This field contains the radio bearer identifier for the radio bearer using the assigned TBF. This provides the mapping of TFI to RB Id which is necessary to uniquely identify Iu-mode data flows.</p>
<p><b>PFI</b> (7 bit field)</p> <p>This field contains the PFI parameter identifying a Packet Flow Context. The PFI parameter is encoded as the contents of the PFI information element as defined in 3GPP TS 44.018.</p>

<p><b>RLC_MODE</b> (1 bit field) This field indicates the RLC mode of the assigned TBF.</p> <p>0 RLC acknowledged mode 1 RLC unacknowledged mode. For the case of an EGPRS TBF an MS that supports RLC non-persistent mode shall respond to this indication of RLC mode as described in the EGPRS Window Size IE (see sub-clause 12.5.2).</p>
<p><b>HFN_LSB</b> (1 bit field) (<i>Iu mode</i> only) This field contains the least significant bit of the downlink HFN of the radio bearer for which the TBF is assigned.</p>
<p><b>NPM Transfer Time</b> (5 bit field) This field contains the NPM Transfer Time limitation in case of RLC non-persistent mode</p> <p>The list of NPM Transfer Time IEs in the Rel-7 additions is ordered as described by the loops in the earlier releases part.</p>
<p><b>Assignment Type</b> (2 bit field) This field is defined in sub-clause 11.2.7.</p>
<p><b>Carrier ID</b> (1 bit field) This identifies the carrier to which the description refers.</p> <p>0 Carrier 1 1 Carrier 2</p>
<p><b>EVENT_BASED_FANR</b> (1 bit field) This field indicates whether the event-based FANR shall be used for the assigned TBF:</p> <p>0 The MS shall not use event-based FANR 1 The MS shall use event-based FANR</p> <p>This field shall be ignored if FANR is not activated. The list of EVENT_BASED_FANR IEs in the Rel-7 additions is ordered as described by the loops in the earlier releases part.</p>
<p><b>DOWNLINK_PDCH_PAIRS_C1</b> <b>DOWNLINK_PDCH_PAIRS_C2</b> <b>UPLINK_PDCH_PAIRS_C1</b> <b>UPLINK_PDCH_PAIRS_C2</b> <b>RTTI_DOWNLINK_PDCH_PAIR_ASSIGNMENT_SC</b> <b>RTTI_DOWNLINK_PDCH_PAIR_ASSIGNMENT_DC</b></p> <p>These fields are defined in sub-clause 11.2.31</p>
<p><b>FANR</b> (1 bit field) This field indicates whether FANR is activated.</p> <p>0 FANR is not activated for the assigned TBFs 1 FANR is activated for the assigned TBFs</p>
<p><b>Downlink EGPRS Level</b> (2 bit field) This field specifies the group of modulation and coding schemes applicable to the TBFs. This information element is defined in sub-clause 12.10f.</p>
<p><b>Indication of Upper Layer PDU Start for RLC UM</b> (1 bit field) This field is defined in section 11.2.7.</p> <p>The list of Indication of Upper Layer PDU Start for RLC UM IEs in the Rel-9 additions is ordered as described by the loops in the earlier releases part.</p>

## 11.2.8 Packet Downlink Dummy Control Block

This message is sent on the PCCCH or PACCH by the network to the mobile station as a fill message with either of the optional parameters PAGE\_MODE and PERSISTENCE\_LEVEL or with no content. In *Iu mode*, it is also sent on FACCH, SACCH and SDCCH.



Message type: PACKET DOWNLINK DUMMY CONTROL BLOCK  
 Direction: network to mobile station  
 Classification: distribution message

**Table 11.2.8.1: PACKET DOWNLINK DUMMY CONTROL BLOCK information elements**

```
< Packet Downlink Dummy Control Block message content > ::=
  < PAGE_MODE : bit (2) >
  { 0 | 1 < PERSISTENCE_LEVEL : bit (4) > * 4 }
  < padding bits >
  ! < Distribution part error : bit (*) = < no string > >;
```

**Table 11.2.8.2: PACKET DOWNLINK DUMMY CONTROL BLOCK information element details**

**PAGE\_MODE** (2 bit field)  
 This field is defined in sub-clause 12.20.

**PERSISTENCE\_LEVEL** (4 bit field for each Radio Priority 1..4)  
 This field is defined in sub-clause 12.14, PRACH Control Parameters.

## 11.2.8b Packet Uplink Dummy Control Block

This message is sent on the PACCH from the mobile station to the network when the mobile station has no other block to transmit. In *Iu mode*, it is also sent on FACCH, SACCH and SDCCH.

Message type: PACKET UPLINK DUMMY CONTROL BLOCK  
 Direction: mobile station to network

**Table 11.2.8b.1: PACKET UPLINK DUMMY CONTROL BLOCK information elements**

```
< Packet Uplink Dummy Control Block message content > ::=
  < TLLI / G-RNTI : bit (32) >
  { null | 0 bit ** = < no string > -- Receiver compatible with earlier release
  | 1 -- Additions in Rel-5 :
    { 0 | 1 < G-RNTI extension : bit (4) > }
  < padding bits > };
```

**Table 11.2.8b.2: PACKET UPLINK DUMMY CONTROL BLOCK information element details**

**TLLI / G-RNTI** (32 bit field)  
 This field contains the TLLI / G-RNTI of the mobile station. This field is encoded as defined in sub-clause 12.16.

**G-RNTI extension** (4 bit field)  
 This field contains the extra 4 bits of the G-RNTI not included in the TLLI / G-RNTI field which are necessary to provide a unique identifier in *Iu mode*.

## 11.2.9 Packet Measurement Report

This message is sent on the PACCH from the mobile station to the network to report measurement results. The message contains measurement results from the Network Control measurements. For a (3G) multi-RAT mobile station, report on 3G cells may be included. For a (E-UTRAN) multi-RAT mobile station, report on E-UTRAN cells may be included.

Message type: PACKET MEASUREMENT REPORT  
 Direction: mobile station to network

Table 11.2.9.1: PACKET MEASUREMENT REPORT message content

```

< Packet Measurement Report message content > ::=
< TLLI / G-RNTI : bit (32) >
{ 0 | 1 < PSI5_CHANGE_MARK : bit (2) > }
0 < NC Measurement Report : < NC Measurement Report struct > >
  { null | 0 bit** = < no string > -- Receiver compatible with earlier release
  | 1 -- Additions in release 99 :
    { 0 | 1 { 0 < BA_USED : bit > < 3G_BA_USED : bit > | 1 < PSI3_CHANGE_MARK : bit(2) > }
    < PMO_USED : bit > }
    { 0 | 1 < 3G Measurement Report : < 3G Measurement Report struct > > }
    { null | 0 bit** = < no string > -- Receiver compatible with earlier release
    | 1 -- Additions in Rel-5 :
      { 0 | 1 < G-RNTI extension : bit (4) > }
      { null | 0 bit** = < no string > -- Receiver compatible with earlier release
      | 1 -- Additions in Rel-8 :
        { 0 | 1 < E-UTRAN Measurement Report : < E-UTRAN Measurement Report struct > > }
        { null | 0 bit** = < no string > -- Receiver compatible with earlier release
        | 1 -- Additions in Rel-9 :
          { 0 | 1 < UTRAN CSG Measurement Report : < UTRAN CSG Measurement Report IE > > }
          { 0 | 1 < E-UTRAN CSG Measurement Report : < E-UTRAN CSG Measurement Report IE > > }
          { null | 0 bit** = < no string > -- Receiver compatible with earlier release
          | 1 -- Additions in Rel-11 :
            < SI23_BA_USED : bit >
            < padding bits > } } } } };

< NC Measurement Report struct > ::=
< NC_MODE : bit (1) >
< RXLEV_SERVING_CELL : bit (6) >
0 -- The value '1' was allocated in an earlier version of the protocol and shall not be used.
< NUMBER_OF_NC_MEASUREMENTS : bit (3) >
{ < FREQUENCY_N : bit (6) >
  { 0 | 1 < BSIC_N : bit (6) > }
  < RXLEV_N : bit (6) > } * (val(NUMBER_OF_NC_MEASUREMENTS));

< 3G Measurement Report struct > ::=
< N_3G : bit (3) >
{ < 3G_CELL_LIST_INDEX : bit (7) >
  < REPORTING_QUANTITY : bit (6) > } * (val(N_3G + 1));

< E-UTRAN Measurement Report struct > ::=
< N_E-UTRAN : bit (2) >
{ < E-UTRAN_FREQUENCY_INDEX : bit (3) >
  < CELL_IDENTITY : bit (9) >
  < REPORTING_QUANTITY : bit (6) > } * (val(N_E-UTRAN + 1));

```

Table 11.2.9.2: PACKET MEASUREMENT REPORT information element details

<b>TLLI / G-RNTI</b> (32 bit field)
This field contains the TLLI / G-RNTI of the mobile station. This field is encoded as defined in sub-clause 12.16.
<b>PSI5_CHANGE_MARK</b> (2 bit field)
This field shall contain the value of the PSI5_CHANGE_MARK in the PSI5 message containing the list of frequencies to measure. If the measurement order has been initiated by a PACKET MEASUREMENT ORDER message, the PSI5_CHANGE_MARK parameter shall be omitted from the message.

<p><b>BA_USED</b> (1 bit field)  <b>3G_BA_USED</b> (1 bit field)  <b>PSI3_CHANGE_MARK</b> (2 bit field)</p> <p>In case of NC measurement report, these fields shall be included and contain the value of the BA_IND, 3G_BA_IND and PSI3_CHANGE_MARK respectively in the messages defining the used Neighbour Cell list and E-UTRAN Neighbour Cell list.</p> <p>In case PBCCH exists, PSI3_CHANGE_MARK shall be used.  In case PBCCH does not exist, BA_USED and 3G_BA_USED shall be used.</p>
<p><b>PMO_USED</b> (1 bit field)</p> <p>This parameter shall contain the value of the PMO_IND in the PACKET CELL CHANGE ORDER or PACKET MEASUREMENT ORDER messages that has modified the used Neighbour Cell list. If no such message has been received, PMO_USED shall be set to zero.</p>
<p><b>NC_MODE</b> (1 bit field)</p> <p>This field indicates if the mobile station was in mode NC1 or NC2 when sending the measurement report.</p> <p>0 Mobile station in mode NC1  1 Mobile station in mode NC2</p>
<p><b>RXLEV_SERVING_CELL</b> (6 bit field)</p> <p>This field contains the value of the RXLEV parameter for the serving cell calculated by the mobile station (see 3GPP TS 45.008). This field is encoded as the binary representation of the RXLEV parameter value defined in 3GPP TS 45.008.  Range 0 to 63</p>
<p><b>FREQUENCY_N</b> (6 bit field)</p> <p>This field indicates the frequency/cell upon which the measurement was made. The field is an index into the resulting Frequency/Cell List for NCmeasurements.</p> <p><b>NC Measurements</b></p> <p>If PBCCH is allocated in the cell, the resulting frequency/cell list for NC Measurements is the GSM Neighbour Cell list defined in sub-clause 5.6.3.2.</p> <p>If PBCCH is not allocated in the cell, the resulting frequency/cell list for NC Measurements is</p> <ul style="list-style-type: none"> <li>- The BA(GPRS) (defined in sub-clause 5.6.3.2) before the MS has acquired the complete GSM Neighbour Cell list from the BCCH messages. In this case, the MS shall not include R99 extension ('Additions in release 99') in the PACKET MEASUREMENT REPORT message.</li> <li>- The GSM Neighbour Cell list (defined in sub-clause 5.6.3.2) after the MS has acquired the complete GSM Neighbour Cell list from the BCCH messages. When the mobile station has acquired the GSM Neighbour Cell list, the mobile station shall include in the measurement reports only cells present in that list.</li> </ul>
<p><b>BSIC_N</b> (6 bit field)</p> <p>This field indicates the BSIC of the frequency upon which the measurement was made. This field shall be included only for frequencies that refer to the BA(BCCH) list. The field is encoded as the BSIC value defined in 3GPP TS 44.018.  Range 0 to 63</p>
<p><b>RXLEV_N</b> (6 bit field)</p> <p>This field indicates the measured RXLEV of the frequency upon which the measurement was made (see 3GPP TS 45.008). This field is encoded as the RXLEV value defined in 3GPP TS 44.018.  Range 0 to 63</p>

<p><b>3G Measurements</b> Measurement reporting for 3G Cells is defined in 3GPP TS 45.008.</p> <p><b>3G_CELL_LIST_INDEX</b> (7 bit field) This is the index of the i'th reported 3G neighbour cell in the 3G Neighbour Cell List. See sub-clause 5.6.3.1.</p> <p><b>REPORTING_QUANTITY</b> (6 bit field) This is the reporting quantity for the i'th reported 3G cell. The quantities are defined in 3GPP TS 45.008 for the respective Radio Access Technology.</p>
<p><b>G-RNTI extension</b> (4 bit field) This field contains the extra 4 bits of the G-RNTI not included in the TLLI / G-RNTI field which are necessary to provide a unique identifier in <i>Iu mode</i>.</p>
<p><b>E-UTRAN Measurements</b> Measurement reporting for E-UTRAN Cells is defined in 3GPP TS 45.008.</p> <p><b>E-UTRAN_FREQUENCY_INDEX</b> (3 bit field) This field contains the index into the frequencies specified as part of the E-UTRAN Neighbour Cell list. This field is described in sub-clause 12.53.</p> <p><b>CELL_IDENTITY</b> (9 bit field) This field contains the physical layer cell identity (as defined in 3GPP TS 36.211) of the cell being reported.</p> <p><b>REPORTING_QUANTITY</b> (6 bit field) This is the reporting quantity for E-UTRAN cell identified by the E-UTRAN frequency and physical layer cell identity. The quantities are defined in 3GPP TS 45.008 for the respective Radio Access Technology.</p>
<p><b>UTRAN CSG Measurement Report</b> Measurement reporting for UTRAN CSG cells is defined in 3GPP TS 45.008. This information element contains the measurement results and routing parameters for one UTRAN CSG or hybrid cell. It is defined in sub-clause 12.61.</p>
<p><b>E-UTRAN CSG Measurement Report</b> Measurement reporting for E-UTRAN CSG cells is defined in 3GPP TS 45.008. This information element contains the measurement results and routing parameters for one E-UTRAN CSG or hybrid cell. It is defined in sub-clause 12.60.</p>
<p><b>SI23_BA_USED</b> (1 bit field) In case of NC measurement report, this field contains the value of the SI 23_BA_IND field in the SYSTEM INFORMATION TYPE 23 message defining the E-UTRAN Neighbour Cell list used. In the case SYSTEM INFORMATION TYPE 23 message is not broadcast in the cell or if the mobile station does not support network sharing this field shall be set to 0. Range 0 to 1.</p>

## 11.2.9b Packet Measurement Order

This message is sent on the PCCCH or PACCH by the network to a mobile station giving information for NC and EXT measurement reporting and network controlled cell reselection. If not all information fits into one message, the remaining information will be sent in other instances of the Packet Measurement Order message.

Message type: PACKET MEASUREMENT ORDER

Direction: network to mobile station

Classification: non-distribution message



```

< NC Frequency list struct > ::=
  { 0 | 1 { < NR_OF_REMOVED_FREQ : bit (5) >
            { < REMOVED_FREQ_INDEX : bit (6) > } * (1 + val(NR_OF_REMOVED_FREQ)) } }
  { 1 < List of added Frequency struct : < Add Frequency list struct > > } ** 0;

< Add Frequency list struct > ::=
  < START_FREQUENCY : bit (10) >
  < BSIC : bit (6) >
  { 0 | 1 < Cell selection params : < Cell Selection struct > > }
  < NR_OF_FREQUENCIES : bit (5) >
  < FREQ_DIFF_LENGTH : bit (3) >
  { < FREQUENCY_DIFF : bit (1+val(FREQ_DIFF_LENGTH)) >
    < BSIC : bit (6) >
    { 0 | 1 < Cell selection params : < Cell Selection struct > > } } * (val(NR_OF_FREQUENCIES));

< Cell Selection struct > ::=
  < CELL_BAR_ACCESS_2 : bit (1) >
  < EXC_ACC : bit >
  < SAME_RA_AS_SERVING_CELL : bit (1) >
  { 0 | 1 < GPRS_RXLEV_ACCESS_MIN : bit (6) >
        < GPRS_MS_TXPWR_MAX_CCH : bit (5) > }
  { 0 | 1 < GPRS_TEMPORARY_OFFSET : bit (3) >
        < GPRS_PENALTY_TIME : bit (5) > }
  { 0 | 1 < GPRS_RESELECT_OFFSET : bit (5) > }
  { 0 | 1 < HCS params : < HCS struct > > }
  { 0 | 1 < SI13_PBCCH_LOCATION : < SI13_PBCCH_LOCATION struct > > } ;

< SI13_PBCCH_LOCATION struct > ::=
  { 0 < SI13_LOCATION : bit (1) >
    | 1 < PBCCH_LOCATION : bit (2) >
      < PSI1_REPEAT_PERIOD : bit (4) > } ;

< HCS struct > ::=
  < PRIORITY_CLASS : bit (3) >
  < HCS_THR : bit (5) > ;

< ENH Measurement parameters struct > ::=
  { 0 < BA_IND : bit > < 3G_BA_IND : bit > | 1 < PSI3_CHANGE_MARK : bit(2) > }
  < PMO_IND : bit >
  < REPORT_TYPE : bit >
  < REPORTING_RATE : bit >
  < INVALID_BSIC_REPORTING : bit >
  { 0 | 1 < 3G Neighbour Cell Description : < 3G Neighbour Cell Description struct >> }
  { 0 | 1 < GPRS REP PRIORITY Description : < GPRS REP PRIORITY Description struct >> }
  { 0 | 1 < GPRS MEASUREMENT Parameters Description :
        < GPRS MEASUREMENT PARAMETERS Description struct >> }
  { 0 | 1 < GPRS 3G MEASUREMENT Parameters Description :
        < GPRS 3G MEASUREMENT PARAMETERS BIS Description struct >> } ;

< 3G Neighbour Cell Description struct > ::=
  { 0 | 1 < Index_Start_3G : bit (7) > }
  { 0 | 1 < Absolute_Index_Start_EMR : bit (7) > }
  { 0 | 1 < UTRAN FDD Description : < UTRAN FDD Description struct > }
  { 0 | 1 < UTRAN TDD Description : < UTRAN TDD Description struct > }
  { 0 | 1 < CDMA2000 Description : < CDMA2000 Description struct > }
  { 0 | 1 < REMOVED_3GCELL_Description : < REMOVED_3GCELL_Description struct >> } ;

< REMOVED_3GCELL_Description struct > ::=
  < N1 : bit (2) >
  { < N2 : bit (5) >
    { < REMOVED_3GCELL_INDEX : bit (7) >
      < 3G_CELL_DIFF_LENGTH : bit (3) >
      < 3GCELL_DIFF : bit (val(3G_CELL_DIFF_LENGTH)) >
    } * (1+val(N2))
  } * (1+val(N1)) ;

```

```

< UTRAN FDD Description struct > ::=
  { 0 | 1 < Bandwidth_FDD : bit (3) > }
  { 1 < Repeated UTRAN FDD Neighbour Cells : Repeated UTRAN FDD Neighbour Cells struct >> } ** 0 ;

< Repeated UTRAN FDD Neighbour Cells struct > ::=
  0 < FDD-ARFCN : bit (14) >   -- The value "1" was used in an earlier
                               -- version of the protocol and shall not be used.

  < FDD_Indic0 : bit >
  < NR_OF_FDD_CELLS : bit (5) >
  < FDD_CELL_INFORMATION Field : bit(p(NR_OF_FDD_CELLS)) > ;
                               -- p(x) defined in table 11.2.9b.2.a/3GPP TS 44.060

< UTRAN TDD Description struct > ::=
  { 0 | 1 < Bandwidth_TDD : bit (3) > }
  { 1 < Repeated UTRAN TDD Neighbour Cells : < Repeated UTRAN TDD Neighbour Cells struct >> } ** 0 ;

< Repeated UTRAN TDD Neighbour Cells struct > ::=
  < TDD_Indic0 : bit >
  0 < TDD-ARFCN : bit (14) >   -- The value "1" was used in an earlier
                               -- version of the protocol and shall not be used.

  < NR_OF_TDD_CELLS : bit (5) >
  < TDD_CELL_INFORMATION Field : bit(q(NR_OF_TDD_CELLS)) > ;
                               -- q(x) defined in table 11.2.9b.2.b/3GPP TS 44.060

< CDMA 2000 Description struct > ::=
  < cdma2000 frequency band : bit (5) >
  < cdma2000 frequency : bit (11) >
  < number_cdma2000_cells : bit (5) >
  { < Pilot PN offset : bit (9) >
    -- this information is enough for 1X Common Pilot
    { 0 | 1 { 000 { < TD_MODE : bit (2) > < TD_POWER_LEVEL : bit (3) > }
      -- additional information for 1X Common Pilot with Transmit Diversity
      | 001 { < QOF : bit (2) > < WALSH_LEN_A : bit (3) >
        < AUX_PILOT_WALSH : bit(val(WALSH_LEN_A)+6)> }
      -- additional information for 1X Auxiliary Pilot
      | 010 { < QOF : bit (2) > < WALSH_LEN_B : bit (3) >
        < AUX_TD_WALSH : bit(val(WALSH_LEN_B)+6)>
        < AUX_TD_POWER_LEVEL : bit (2) > < TD_MODE : bit (2) > }
      -- additional information for 1X Auxiliary Pilot with Transmit Diversity
      | 011 { < SR3_PRIM_PILOT : bit (2) > < SR3_PILOT_POWER1 : bit (3) >
        < SR3_PILOT_POWER2 : bit (3) > }
      -- additional information for 3X Common Pilot
      | 110 { < SR3_PRIM_PILOT : bit (2) > < SR3_PILOT_POWER1 : bit (3) >
        < SR3_PILOT_POWER2 : bit (3) > < QOF : bit (2) >
        < WALSH_LEN_C : bit (3) >
        < AUX_WALSH_LEN : bit(val(WALSH_LEN_C)+6)>
        { 0 | 1 < QOF1 : bit (2) > < WALSH_LENGTH1 : bit (3) >
          < AUX_PILOT_WALSH1 : bit(val(WALSH_LENGTH1)+6)> }
        { 0 | 1 < QOF2 : bit (2) > < WALSH_LENGTH2 : bit (3) >
          < AUX_PILOT_WALSH2 : bit(val(WALSH_LENGTH2)+6)> } }
      -- additional information for 3X Auxiliary Pilot
    }
  }
  } * val(number_cdma2000_cells) ;

< GPRS REP PRIORITY Description struct > ::=
  < Number_Cells : bit(7) >
  { < REP_PRIORITY : bit > } * (val(Number_Cells)) ;

```

```

< GPRS MEASUREMENT PARAMETERS Description struct > ::=
  { 0 | 1 < MULTIBAND_REPORTING : bit (2) > }
  { 0 | 1 < SERVING_BAND_REPORTING : bit (2) > }
  < SCALE_ORD : bit(2) >

  { 0 | 1 < 900_REPORTING_OFFSET : bit (3) >
    < 900_REPORTING_THRESHOLD : bit (3) > }

  { 0 | 1 < 1800_REPORTING_OFFSET : bit (3) >
    < 1800_REPORTING_THRESHOLD : bit (3) > }

  { 0 | 1 < 400_REPORTING_OFFSET : bit (3) >
    < 400_REPORTING_THRESHOLD : bit (3) > }

  { 0 | 1 < 1900_REPORTING_OFFSET : bit (3) >
    < 1900_REPORTING_THRESHOLD : bit (3) > }

  { 0 | 1 < 850_REPORTING_OFFSET : bit (3) >
    < 850_REPORTING_THRESHOLD : bit (3) > } ;

< GPRS 3G MEASUREMENT PARAMETERS BIS Description struct > ::=
  < Qsearch_P : bit (4) >
  { 1 ! < Ignore : bit = < no string >> }          -- this bit shall be ignored by the receiver
                                                    -- for backward compatibility with earlier releases

  { 0 | 1 < FDD_REP_QUANT : bit >                -- FDD Parameters
    < FDD_MULTIRAT_REPORTING : bit (2) > }

  { 0 | 1 < FDD_REPORTING_OFFSET : bit (3) >
    < FDD_REPORTING_THRESHOLD : bit (3) > }

  { 0 | 1 < TDD_MULTIRAT_REPORTING : bit (2) > }          -- TDD Parameters
  { 0 | 1 < TDD_REPORTING_OFFSET : bit (3) >
    < TDD_REPORTING_THRESHOLD : bit (3) > }

  { 0 | 1 < CDMA2000_MULTIRAT_REPORTING : bit (2) > }      -- CDMA2000 Parameters
  { 0 | 1 < CDMA2000_REPORTING_OFFSET : bit (3) >
    < CDMA2000_REPORTING_THRESHOLD : bit (3) > } ;

< CCN Support Description struct > ::=
< Number_Cells : bit (7) >
{ CCN_SUPPORTED : bit } * (val(Number_Cells)) ;
< lu Mode Neighbour Cell Params struct > ::=
  { 0 | 1 < lu Mode Cell Selection Params : < lu Mode Cell Selection struct > > }
    < NR_OF_FREQUENCIES : bit (5) >
    { 0 | 1 < lu Mode Cell Selection Params :
      < lu Mode Cell Selection struct > > } * (val(NR_OF_FREQUENCIES)) ;
< lu Mode Cell Selection struct > ::=
  < CELL_BAR_QUALIFY 3 : bit (2) >
  { 0 | 1 < SI13Alt PBCCH Location: < SI13 PBCCH Location struct > > } ;
< NC lu Mode Only Cell List struct > ::=
  { 1 < List of added cells : < Add lu Mode Only Cell List struct > > } ** 0;
< Add lu Mode Only Cell List struct > ::=
  < START_FREQUENCY : bit (10) >
  < BSIC : bit (6) >
  { 0 | 1 < Cell selection params : < lu Mode Only Cell Selection struct > > }
    < NR_OF_FREQUENCIES : bit (5) >
    < FREQ_DIFF_LENGTH : bit (3) >
    { < FREQUENCY_DIFF : bit (val(FREQ_DIFF_LENGTH)) >
    < BSIC : bit (6) >
    { 0 | 1 < Cell selection params :
      < lu Mode Only Cell Selection struct > > } } * (val(NR_OF_FREQUENCIES)) ;

```



```

< lu Mode Only Cell Selection struct > ::=
  < CELL_BAR_QUALIFY_3 : bit (2) >
  < SAME_RA_AS_SERVING_CELL : bit (1) >
  { 0 | 1 < GPRS_RXLEV_ACCESS_MIN : bit (6) >
    < GPRS_MS_TXPWR_MAX_CCH : bit (5) > }
  { 0 | 1 < GPRS_TEMPORARY_OFFSET : bit (3) >
    < GPRS_PENALTY_TIME : bit (5) > }
  { 0 | 1 < GPRS_RESELECT_OFFSET : bit (5) > }
  { 0 | 1 < HCS_params : < HCS struct > > }
  { 0 | 1 < SI13Alt_PBCCH_LOCATION : < SI13_PBCCH_LOCATION struct > > } ;

< GPRS 3G Additional Measurement Parameters Description 2 struct > ::=
  { 0 | 1 < FDD_REPORTING_THRESHOLD_2 : bit (6) > } ;
  -- FDD Parameters

< Priority and E-UTRAN Parameters Description struct > ::=
  { 0 | 1 < Serving Cell Priority Parameters Description : < GSM Priority Parameters IE >> }
  { 0 | 1 < 3G Priority Parameters Description : < 3G Priority Parameters IE >> }
  { 0 | 1 < E-UTRAN Parameters Description : < E-UTRAN Parameters IE >> } ;

< CSG Cells Reporting Description struct > ::=
  { 0 | 1 < UTRAN CSG Cells Reporting Description : < UTRAN CSG Cells Reporting Description struct >> }
  { 0 | 1 < E-UTRAN CSG Cells Reporting Description : < E-UTRAN CSG Cells Reporting Description struct >> } ;

< UTRAN CSG Cells Reporting Description struct > ::=
  { 0 | 1 < UTRAN_CSG_FDD_REPORTING_THRESHOLD : bit (3) >
    < UTRAN_CSG_FDD_REPORTING_THRESHOLD_2 : bit (6) > }
  { 0 | 1 < UTRAN_CSG_TDD_REPORTING_THRESHOLD : bit (3) > } ;

< E-UTRAN CSG Cells Reporting Description struct > ::=
  { 0 | 1 < E-UTRAN_CSG_FDD_REPORTING_THRESHOLD : bit (3) >
    < E-UTRAN_CSG_FDD_REPORTING_THRESHOLD_2 : bit (6) > }
  { 0 | 1 < E-UTRAN_CSG_TDD_REPORTING_THRESHOLD : bit (3) >
    < E-UTRAN_CSG_TDD_REPORTING_THRESHOLD_2 : bit (6) > } ;

```

**Table 11.2.9b.2 : Packet Measurement Order information element details**

The Packet Measurement Order message contains measurement parameters either for Network Control measurements. If parameters for the NC measurements are not included, a previous Packet Measurement Order message belonging to the same set of messages shall still be valid.

The 'NC measurement parameters struct' contains the Network Control Order, the NC parameters and an NC Frequency List struct. If the value of the Network Control Order or any of the NC parameters differs between instances of the message, the value of the parameter in the instance with the highest PMO\_INDEX shall be valid and all others shall be ignored.

If included the NC Frequency List struct is a deviation list which contains removed or added frequencies to the BA(GPRS) list (see 3GPP TS 45.008). The building of the resulting GSM Neighbour Cell list is defined in sub-clause 5.6.3.2.

The 'LSA parameters IE' contains a list of LSA\_ID(s) corresponding to the entries in the 'Add Frequency list struct'. Some entries in 'LSA parameters IE' may be empty. The entries in the two structures are listed in the same order and the number of entries (nr\_of\_frequencies) should be the same. In case there are too few entries in the 'LSA parameters IE', empty entries shall be added at the end. In case there are too many entries in the 'LSA parameters IE', the last shall be discarded. The 'LSA parameters IE' is defined in sub-clause 12.28.

The 'ENH Measurement parameters structure' contains information for performing enhanced measurements and reporting the measurement with the PACKET MEASUREMENT REPORT or PACKET ENHANCED MEASUREMENT REPORT message. For a 3G multi-RAT mobile station it may also include information for reporting on 3G Cells.

**PAGE\_MODE** (2 bit field)

This field is defined in sub-clause 12.20.

<p><b>PMO_INDEX</b> (3 bit field) and <b>PMO_COUNT</b> (3 bit field)</p> <p>The purpose of the PMO_INDEX field and the PMO_COUNT field is to indicate the number of individual messages within the sequence of Packet Measurement Order messages and to assign an index to identify each one of them. The PMO_INDEX field is binary coded, range: 0 to 7, and provides an index to identify the individual Packet Measurement Order message. The PMO_COUNT field is binary coded, range: 0 to 7, and provides the PMO_INDEX value for the last (highest indexed) message in the sequence of Packet Measurement Order messages. A measurement order shall not be effected by the mobile station until all instances of a Packet Measurement Order message is received.</p> <p><b>Global TFI</b></p> <p>If present, this information element indicates the mobile station to which this message is addressed. This field is defined in sub-clause 12.10.</p>												
<p><b>TLLI / G-RNTI</b> (32 bit field)</p> <p>If present, this field indicates the mobile station to which this message is addressed. This field is defined in sub-clause 12.16.</p> <p><b>CCN_ACTIVE</b> (1 bit field)</p> <p>This field indicates whether CCN is enabled in the serving cell for the mobile station when reselecting to a GSM cell. It is coded as follows:</p> <p>0 The broadcast CCN_ACTIVE parameter shall apply if available. Otherwise CCN is disabled in the cell for the mobile station when reselecting to a GSM cell.</p> <p>1 CCN is enabled in the cell for the mobile station when reselecting to a GSM cell.</p> <p>The NC Measurement Parameters gives the parameters for the serving cell and may contain frequency list deviations (add/delete) to the BA(GPRS) either on PBCCH or on BCCH.</p> <p>The <b>NC_Measurement_Parameters struct</b> contains the NETWORK_CONTROL_ORDER and the optional parameters NC_NON_DRX_PERIOD, NC_REPORTING_PERIOD_I, NC_REPORTING_PERIOD_T and the NC_FREQUENCY LIST.</p>												
<p><b>NETWORK_CONTROL_ORDER</b> (2 bit field)</p> <p>The NETWORK_CONTROL_ORDER field is coded according to the following table (for definition of NCx see 3GPP TS 45.008):</p> <table border="1"> <tr><td>Bit</td><td></td></tr> <tr><td>2 1</td><td></td></tr> <tr><td>0 0</td><td>NC0</td></tr> <tr><td>0 1</td><td>NC1</td></tr> <tr><td>1 0</td><td>NC2</td></tr> <tr><td>1 1</td><td>RESET</td></tr> </table>	Bit		2 1		0 0	NC0	0 1	NC1	1 0	NC2	1 1	RESET
Bit												
2 1												
0 0	NC0											
0 1	NC1											
1 0	NC2											
1 1	RESET											
<p><b>NC_NON_DRX_PERIOD</b> (3 bit field)</p> <p><b>NC_REPORTING_PERIOD_I</b> (3 bit field)</p> <p><b>NC_REPORTING_PERIOD_T</b> (3 bit field)</p> <p>For detailed element definitions, see the PSI5 message.</p>												
<p><b>NR_OF_REMOVED_FREQ</b> (5 bit field)</p> <p>1+val(NR_OF_REMOVED_FREQ) indicates the number of frequencies in the BA-list which shall not be used for NC-measurements and gives the number of instances of the parameter REMOVED_FREQ_INDEX.</p> <p>Range of NR_OF_REMOVED_FREQ: 0 to 31.</p>												
<p><b>REMOVED_FREQ_INDEX</b> (6 bit field)</p> <p>This field indicates the index to the frequency to be removed in the BA(GPRS) sent on PBCCH or on BCCH, see sub-clause 5.6.3.2.</p> <p>Range: 0 to 63.</p> <p>Add Frequency list struct contains the frequency list for NC measurements.</p>												
<p><b>START_FREQUENCY</b> (10 bit field)</p> <p><b>FREQ_DIFF_LENGTH</b> (3 bit field)</p> <p><b>FREQUENCY_DIFF</b> (1+val(FREQ_DIFF_LENGTH) bit field)</p> <p>For detailed element definition of these parameters, see the PSI5 message.</p>												

**BSIC** (6 bit field)

This field is encoded as the 'Base Station Identity Code' defined in 3GPP TS 23.003.

Range 0 to 63

The **Cell selection params** in the Add Frequency list struct shall be present for the first neighbour cell added by the message. For description of the cell selection parameters see Table: *PSI3 information element details*

As an abnormal case, if the **Cell selection params** is missed for the first neighbour cell added by the message then the same parameters as the serving cell shall be applied as default value:

If PBCCH is present in the serving cell then :

CELL_BAR_ACCESS_2 :	Serving cell CELL_BAR_ACCESS_2
EXC_ACC :	Serving cell EXC_ACC
SAME_RA_AS_SERVING_CELL :	<i>The cell is in the same Routeing Area as the serving cell</i>
GPRS_RXLEV_ACCESS_MIN :	Serving cell GPRS_RXLEV_ACCESS_MIN
GPRS_MS_TXPWR_MAX_CCH :	Serving cell GPRS_MS_TXPWR_MAX_CCH
GPRS_TEMPORARY_OFFSET :	0 dB
GPRS_PENALTY_TIME :	<i>Undefined</i>
GPRS_RESELECT_OFFSET :	0 dB
HCS_THR :	Serving cell HCS_THR
PRIORITY_CLASS :	Serving cell PRIORITY_CLASS
SI13_PBCCH_LOCATION :	<i>Undefined.</i>

If PBCCH is not present in the serving cell then :

CELL_BAR_ACCESS_2 :	Serving cell CELL_BAR_ACCESS
EXC_ACC :	Serving cell cell exclusive access support capability
SAME_RA_AS_SERVING_CELL :	<i>The cell is in the same Routeing Area as the serving cell</i>
The other parameters default values take the same values as if the structure is present and optional fields are omitted (see below).	

In case the cell selection params is given and if PBCCH is not present in the serving cell, optional parameters which are not present shall be affected with the following default values :

GPRS_RXLEV_ACCESS_MIN :	Serving cell RXLEV_ACCESS_MIN
GPRS_MS_TXPWR_MAX_CCH :	Serving cell MS_TXPWR_MAX_CCH
GPRS_TEMPORARY_OFFSET :	0 dB
GPRS_PENALTY_TIME :	<i>Undefined</i>
GPRS_RESELECT_OFFSET :	0 dB
HCS_THR :	infinity
PRIORITY_CLASS :	undefined
SI13_PBCCH_LOCATION :	undefined

In case the cell selection params is given and if PBCCH is present in the serving cell, optional parameters which are not present shall be affected with the following default values :

GPRS_RXLEV_ACCESS_MIN :	Serving cell GPRS_RXLEV_ACCESS_MIN
GPRS_MS_TXPWR_MAX_CCH :	Serving cell GPRS_MS_TXPWR_MAX_CCH
GPRS_TEMPORARY_OFFSET :	0 dB
GPRS_PENALTY_TIME :	<i>Undefined</i>
GPRS_RESELECT_OFFSET :	0 dB
HCS_THR :	Serving cell HCS_THR
PRIORITY_CLASS :	Serving cell PRIORITY_CLASS
SI13_PBCCH_LOCATION :	<i>Undefined.</i>

The following neighbour cells defined in the message use the parameter values of the previous neighbour cell as their default values.

<p><b>ENH Measurement Parameters:</b></p> <p><b>BA_IND</b> (1 bit field)  <b>3G_BA_IND</b> (1 bit field)  <b>PSI3_CHANGE_MARK</b> (2 bit field)</p> <p>These parameters are needed to allow the mobile station to associate the removed/added cells or frequencies to the correct Neighbour Cell list. The values of this parameters are reflected in the PACKET ENHANCED MEASUREMENT REPORT message and in the PACKET MEASUREMENT REPORT message.</p>
<p><b>PMO_IND</b> (1 bit field)</p> <p>This parameter is needed to allow the network to discriminate measurements results related to Neighbour Cell list modified by different Packet Cell Change Order or Packet Measurement Order messages sent to the MS. The value of this parameter is reflected in the PACKET ENHANCED MEASUREMENT REPORT message and in the PACKET MEASUREMENT REPORT message.</p>
<p><b>REPORT_TYPE</b> (1 bit)</p> <p>This parameter is used to indicate to the mobile station to use the PACKET MEASUREMENT REPORT or PACKET ENHANCED MEASUREMENT REPORT messages for (NC) reporting:</p> <p>If the cell has a PBCCH allocated:</p> <p><b>Bit</b></p> <p><b>0</b> The mobile station shall use the PACKET ENHANCED MEASUREMENT REPORT message for (NC) reporting  <b>1</b> The mobile station shall use the PACKET MEASUREMENT REPORT message for (NC) reporting</p> <p>If the cell has no PBCCH allocated:</p> <p><b>Bit</b></p> <p><b>0</b> The mobile station shall use the PACKET ENHANCED MEASUREMENT REPORT message for (NC) reporting if at least one BSIC is allocated to each BA(GPRS) frequency. Otherwise, the PACKET MEASUREMENT REPORT shall be used.  <b>1</b> The mobile station shall use the PACKET MEASUREMENT REPORT message for (NC) reporting</p>
<p><b>REPORTING_RATE</b> (1 bit)</p> <p>This parameter is used for measurements, see 3GPP TS 45.008.</p> <p><b>bit</b></p> <p><b>0</b> Normal rate reporting  <b>1</b> Reduced reporting rate allowed</p>
<p><b>INVALID_BSIC_REPORTING</b> (1 bit)</p> <p>This field specifies if cells with invalid BSIC and allowed NCC part of BSIC are allowed to be reported or not, see 3GPP TS 45.008.</p> <p><b>bit</b></p> <p><b>0</b> Report on cells with invalid BSIC and allowed NCC part of BSIC is not allowed.  <b>1</b> Report on cells with invalid BSIC and allowed NCC part of BSIC is allowed. In this case NCC_PERMITTED is required in PSI5.</p>
<p><b>3G Neighbour Cell Description:</b></p> <p>The building of the 3G Neighbour Cell list and the ordering of indices within each Radio Access Technology is described in sub-clause 5.6.3.1.</p>
<p><b>Index_Start_3G</b> (7 bit)</p> <p>This optional information element indicates the value of the first index to use to build this instance of the 3G Neighbour Cell list. When missing, the value 0 is assumed. See sub-clause 5.6.3.1.</p>

<p><b>Absolute_Index_Start_EMR</b> (7 bit)</p> <p>This parameter indicates the value to be added to the indices of the 3G Neighbour Cell list for reporting 3G Cells with the PACKET ENHANCED MEASUREMENT REPORT message (see sub-clause 5.6.3.3). If present, it overrides the parameter value of the reference 3G Neighbour Cell list. If different values are received for this parameter in different instances of this message, the instance with the highest index shall be used.</p> <p>NOTE: This parameter is not used for reporting 3G Cells with the PACKET MEASUREMENT REPORT message, see sub-clause 11.2.9.</p>																																																
<p><b>UTRAN FDD Description:</b></p> <p><b>Bandwidth_FDD</b> (3 bit field)</p> <p>This information element will be used for future releases of the protocol. When missing, this indicates the present FDD bandwidth. When present, this shall not be considered as an error; indices of the 3G Neighbour Cell list shall be incremented accordingly.</p> <p><b>FDD_ARFCN</b> (14 bit field)</p> <p>This information element is defined as the UARFCN in 3GPP TS 25.101. Any non-supported frequency shall not be considered as an error; indices of the 3G Neighbour Cell list shall be incremented accordingly.</p>																																																
<p><b>FDD_Indic0</b>, information 0 indicator (1 bit):</p> <p>This field indicates if the Scrambling Code/Diversity parameter value '0000000000' is a member of the set.</p> <p>Bit</p> <p>0 parameter value '0000000000' is not a member of the set</p> <p>1 parameter value '0000000000' is a member of the set</p> <p>NOTE: This bit FDD_Indic0 is equivalent to the bit F0 bit in the frequency list information element (see 3GPP TS 44.018).</p>																																																
<p><b>NR_OF_FDD_CELLS</b> (5 bit field)</p> <p>This field defines the number of FDD_CELL_INFORMATION parameters.</p>																																																
<p><b>FDD_CELL_INFORMATION Field</b> (p bit field)</p> <p>This field allows to compute a set of 10-bit-long FDD_CELL_INFORMATION parameters, re-using the <i>Range 1024 format</i> compression algorithm, see 3GPP TS 44.018 Annex J: 'Algorithm to encode frequency list information'. The formulas for decoding are given in 3GPP TS 44.018: 'Range 1024 format'. The consecutive parameters of this field are concatenated, starting with w1, and then w2, w3...</p> <p>The total number of bits p of this field depends on the value of the parameter NR_OF_FDD_CELLS = n, as follows:</p> <table border="1"> <thead> <tr> <th>n</th> <th>p</th> <th>n</th> <th>p</th> <th>n</th> <th>p</th> <th>n</th> <th>p</th> </tr> </thead> <tbody> <tr> <td>0</td> <td>0</td> <td>5</td> <td>44</td> <td>10</td> <td>81</td> <td>15</td> <td>116</td> </tr> <tr> <td>1</td> <td>10</td> <td>6</td> <td>52</td> <td>11</td> <td>88</td> <td>16</td> <td>122</td> </tr> <tr> <td>2</td> <td>19</td> <td>7</td> <td>60</td> <td>12</td> <td>95</td> <td>17-31</td> <td>0</td> </tr> <tr> <td>3</td> <td>28</td> <td>8</td> <td>67</td> <td>13</td> <td>102</td> <td></td> <td></td> </tr> <tr> <td>4</td> <td>36</td> <td>9</td> <td>74</td> <td>14</td> <td>109</td> <td></td> <td></td> </tr> </tbody> </table> <p>Table 11.2.9b.2.a</p> <p>If n=0 and FDD_Indic0 = 0, this indicates the 3G Neighbour Cell list index for report on RSSI, see 3GPP TS 45.008.</p> <p>If n is equal or greater than 17, this shall not be considered as an error; the corresponding index in the 3G Neighbour Cell list shall be incremented by one. The entry created in the 3G Neighbour Cell list does not contain valid information.</p> <p>For each (10-bit-long) decoded parameter, bits 1-9 are the Scrambling Code and bit 10 is the Diversity bit.</p>	n	p	n	p	n	p	n	p	0	0	5	44	10	81	15	116	1	10	6	52	11	88	16	122	2	19	7	60	12	95	17-31	0	3	28	8	67	13	102			4	36	9	74	14	109		
n	p	n	p	n	p	n	p																																									
0	0	5	44	10	81	15	116																																									
1	10	6	52	11	88	16	122																																									
2	19	7	60	12	95	17-31	0																																									
3	28	8	67	13	102																																											
4	36	9	74	14	109																																											
<p><b>Scrambling Code</b> (9 bit field)</p> <p>This parameter indicates the Primary Scrambling Code as defined in 3GPP TS 25.213.</p>																																																

<p><b>Diversity</b> (1 bit field)</p> <p>This parameter indicates if diversity is applied for the cell:</p> <p>Bit</p> <p>0 Diversity is not applied for this cell</p> <p>1 Diversity is applied for this cell.</p>																																																												
<p><b>UTRAN TDD Description:</b></p> <p><b>Bandwidth_TDD</b> (3bit field)</p> <p>This optional information element refers to 3GPP TS 25.331.</p> <p>Bit</p> <p>321</p> <p>000 3,84 Mcps</p> <p>001 1,28 Mcps</p> <p>All other values shall not be interpreted as an error; indices of the 3G Neighbour Cell list shall be incremented accordingly (but no reporting can be performed). When missing, this indicates 3,84 Mcps.</p>																																																												
<p><b>TDD_ARFCN</b> (14 bit field)</p> <p>This optional information element is defined as the UARFCN in 3GPP TS 25.102. Any non supported frequency shall not be considered as an error; indices of the 3G Neighbour Cell list shall be incremented accordingly.</p>																																																												
<p><b>TDD_Indic0</b>, information 0 indicator (1 bit):</p> <p>This field indicates if the Cell_Parameter/Sync_Case/Diversity parameter value '0000000000' is a member of the set.</p> <p>Bit</p> <p>0 parameter value '0000000000' is not a member of the set</p> <p>1 parameter value '0000000000' is a member of the set</p>																																																												
<p><b>NR_OF_TDD_CELLS</b> (5 bit field)</p> <p>This field defines the decimal value of the number of TDD_CELL_INFORMATION parameters.</p>																																																												
<p><b>TDD_CELL_INFORMATION Field</b> (q bit field)</p> <p>This field allows to compute a set of 9-bit-long TDD_CELL_INFORMATION parameters, re-using the <i>Range 512 format</i> compression algorithm, see 3GPP TS 44.018 Annex J: 'Algorithm to encode frequency list information'. The formulas for decoding are given in 3GPP TS 44.018 sub-clause 10.5.2.13.4: 'Range 512 format', with w0=0. The consecutive parameters of this field are concatenated, starting with w1, and then w2, w3...</p> <p>The total number of bits q of this field depends on the value of the parameter NR_OF_TDD_CELLS = m, as follows:</p> <table border="1"> <thead> <tr> <th>m</th><th>q</th><th>m</th><th>q</th><th>m</th><th>q</th><th>m</th><th>q</th><th>m</th><th>q</th></tr> </thead> <tbody> <tr> <td>0</td><td>0</td><td>5</td><td>39</td><td>10</td><td>71</td><td>15</td><td>101</td><td>20</td><td>126</td></tr> <tr> <td>1</td><td>9</td><td>6</td><td>46</td><td>11</td><td>77</td><td>16</td><td>106</td><td>21-31</td><td>0</td></tr> <tr> <td>2</td><td>17</td><td>7</td><td>53</td><td>12</td><td>83</td><td>17</td><td>111</td><td></td><td></td></tr> <tr> <td>3</td><td>25</td><td>8</td><td>59</td><td>13</td><td>89</td><td>18</td><td>116</td><td></td><td></td></tr> <tr> <td>4</td><td>32</td><td>9</td><td>65</td><td>14</td><td>95</td><td>19</td><td>121</td><td></td><td></td></tr> </tbody> </table> <p><i>Table 11.2.9b.2.b.</i></p> <p>If m=0 and TDD_Indic0=0, or m is equal or greater than 21, this shall not be considered as an error; the corresponding index in the 3G Neighbour Cell list shall be incremented by one. The entry created in the 3G Neighbour Cell list does not contain valid information.</p> <p>For each (9-bit-long) decoded parameter, bits 1-7 are the Cell Parameter, bit 8 is the Sync Case TSTD and bit 9 is the Diversity TDD bit.</p>	m	q	m	q	m	q	m	q	m	q	0	0	5	39	10	71	15	101	20	126	1	9	6	46	11	77	16	106	21-31	0	2	17	7	53	12	83	17	111			3	25	8	59	13	89	18	116			4	32	9	65	14	95	19	121		
m	q	m	q	m	q	m	q	m	q																																																			
0	0	5	39	10	71	15	101	20	126																																																			
1	9	6	46	11	77	16	106	21-31	0																																																			
2	17	7	53	12	83	17	111																																																					
3	25	8	59	13	89	18	116																																																					
4	32	9	65	14	95	19	121																																																					
<p><b>Cell Parameter</b> (7 bit field)</p> <p>This parameter is defined in 3GPP TS 25.223.</p>																																																												

<p><b>Sync Case TSTD</b> (1 bit field) For 3.84 Mcps TDD, this parameter is defined in 3GPP TS 25.223. Bit 0 Sync Case 1 1 Sync Case 2</p> <p>For 1.28 Mcps TDD, this parameter indicates if TSTD (see 3GPP TS 25.224) is applied for the cell: Bit 0 TSTD is not applied for this cell 1 TSTD is applied for this cell.</p>
<p><b>Diversity TDD</b> (1 bit field) This parameter indicates if SCTD (see 3GPP TS 25.224) is applied for the cell: Bit 0 SCTD is not applied for this cell 1 SCTD is applied for this cell.</p>
<p><b>CDMA 2000 Description:</b></p> <p><b>cdma2000 frequency band</b> (5 bit field) A binary representation of cdma2000 BAND_CLASS, as defined in TIA/EIA-IS-2000-5-A. The mobile station shall ignore all the information relative to a cdma2000 frequency band that it can not support.</p> <p><b>cdma2000 frequency</b> (11 bit field) A binary representation of cdma2000 CDMA_FREQ, as defined in TIA/EIA-IS-2000-5-A. The mobile station shall ignore all the information relative to a cdma2000 frequency that it can not support.</p>
<p><b>number_cdma2000_cells</b> (5 bit field) This field indicates the number of CDMA 2000 neighbour cells.</p>
<p><b>Pilot PN offset</b> (9 bit field) A binary representation of the PN offset of the Pilot PN sequence (in units of 64 cdma2000 1x-chips), PILOT_PN, as defined in TIA/EIA-IS-2000-5-A.</p>
<p><b>TD_MODE</b> (2 bit field) An indication of transmit diversity mode is specified in TIA/EIA-IS-2000-5-A. The mobile station shall ignore TD_MODE if it does not support 1X Common Pilot with Transmit Diversity.</p>
<p><b>TD_POWER_LEVEL</b> (3 bit field) Power level of the Transmit Diversity Pilot relative to that of the Forward Pilot Channel as specified in TIA/EIA/IS-2000-5-A. The mobile station shall ignore TD_POWER_LEVEL if it does not support 1X Common Pilot with Transmit Diversity.</p>
<p><b>QOF</b> (2 bit field) Quasi-orthogonal function index is defined in TIA/EIA/IS-2000-5-A. The mobile station shall ignore QOF if it does not support the quasi-orthogonal function.</p>
<p><b>WALSH_LEN_A, WALSH_LEN_B and WALSH_LEN_C</b> (3 bit field each) A three bit field to indicate the length of the Walsh code for the pilot that is used in as the Auxiliary Pilot, and specified as WALSH_LEN in TIA/EIA/IS-2000-5-A. The mobile station shall ignore WALSH_LEN if it does not support 1X Auxiliary Pilot.</p>

<p><b>AUX_PILOT_WALSH</b> (var.Length field) Indicates the walsh code corresponding to the Auxiliary Pilot, as specified in TIA/EIA/IS-2000-5-A. The mobile station shall ignore AUX_PILOT_WALSH if it does not support 1X Auxiliary Pilot.</p> <p><b>AUX_TD_WALSH</b> (var.Length field) Indicates the walsh code corresponding to the Auxiliary Transmit Diversity Pilot, as specified in TIA/EIA/IS-2000-5-A. The mobile station shall ignore AUX_TD_WALSH if it does not support 1X Auxiliary Pilot with Transmit Diversity.</p> <p><b>AUX_TD_POWER_LEVEL</b> (2 bit field) Power level of the Auxiliary Transmit Diversity Pilot relative to that of the Forward Pilot Channel as specified in TIA/EIA/IS-2000-5-A. The mobile station shall ignore AUX_TD_POWER_LEVEL if it does not support 1X Auxiliary Pilot with Transmit Diversity.</p>
<p><b>SR3_PRIM_PILOT</b> (3 bit field) Position of the primary SR3 pilot as specified in TIA/EIA/IS-2000-5-A. The mobile station shall ignore SR3_PRIM_PILOT if it does not support 3X Common Pilot.</p> <p><b>SR3_PILOT_POWER1</b> (3 bit field), relative power level between the primary SR3 pilot and the pilot on the lower frequency of the two remaining SR3 frequencies, as specified in TIA/EIA/IS-2000-5-A. The mobile station shall ignore SR3_PILOT_POWER1 if it does not support 3X Common Pilot.</p> <p><b>SR3_PILOT_POWER2</b> (3 bit field), relative power level between the primary SR3 pilot and the pilot on the higher frequency of the two remaining SR3 frequencies, as specified in TIA/EIA/IS-2000-5-A. The mobile station shall ignore SR3_PILOT_POWER2 if it does not support 3X Common Pilot.</p>
<p><b>QOF1</b> (2 bit field), <b>WALSH_LEN1</b> (3 bit field) and <b>AUX_PILOT_WALSH1</b> (var. Length field) The corresponding quantities for pilot on the lower frequency of the two remaining SR3 frequencies, as specified in TIA/EIA/IS-2000-5-A. The mobile station shall ignore QOF1, WALSH_LEN1 and AUX_PILOT_WALSH1 if it does not support 3X Auxiliary Pilot.</p> <p><b>QOF2</b> (2 bit field), <b>WALSH_LENGTH2</b> (3 bit field) and <b>AUX_PILOT_WALSH2</b> (var Length field) The corresponding quantities for pilot on the higher frequency of the two remaining SR3 frequencies, as specified in TIA/EIA/IS-2000-5-A. The mobile station shall ignore QOF2, WALSH_LEN2 and AUX_PILOT_WALSH2 if it does not support 3X Auxiliary Pilot.</p>
<p><b>REMOVED_3GCELL_Description</b> This struct contains a list of cells to be removed from the 3G Neighbour Cell list for measurements (see sub-clause 5.6.3.1). The cells are identified by their index. The struct consists of N1 sublists, each comprising the following three parameters:</p> <p><b>REMOVED_3GCELL_INDEX</b> (7 bit field) This field indicates the index of the first cell in the sublist.</p> <p><b>3G_CELL_DIFF_LENGTH</b> (3 bit field) This field indicates the number of bits used for the 3GCELL_DIFF field in the current sublist.</p> <p><b>3GCELL_DIFF</b> (variable size) This field indicates the difference in index to the next cell in the sublist.</p>
<p><b>GPRS REP PRIORITY Description</b></p> <p><b>REP_PRIORITY bit:</b></p> <p><b>0</b> Normal reporting priority</p> <p><b>1</b> High reporting priority</p> <p>The use of these bits is defined in sub-clause 5.6.3.5 and 3GPP TS 45.008.</p>



<p><b><i>GPRS MEASUREMENT PARAMETERS Description</i></b>  The fields of this Description are used for measurements, as defined in 3GPP TS 45.008.  Any parameter present overwrites any old data held by the mobile station for this parameter.</p> <p><b><i>GPRS 3G MEASUREMENT PARAMETERS Description</i></b>  The fields of this Description are used for measurements, as defined in 3GPP TS 45.008.  Any parameter present overwrites any old data held by the mobile station for this parameter.</p> <p><b><i>GPRS 3G Additional Measurement Parameters Description 2</i></b>  The fields of this Description are used for measurements, as defined in 3GPP TS 45.008.  Any parameter present overwrites any old data held by the mobile station for this parameter.</p>
<p><b><i>CCN Support Description</i></b></p> <p><b>CCN_SUPPORTED</b> (1 bit field)  This parameter is used for determining whether the mobile station shall enter CCN mode when re-selecting a cell and CCN is enabled. The use of these bits is described in sub-clause 8.8.2a ("CCN support description"):  Bit  <b>0</b> CCN is enabled towards the corresponding cell  <b>1</b> CCN is disabled towards the corresponding cell</p>
<p><b>G-RNTI extension</b> (4 bit field)  This field contains the extra 4 bits of the G-RNTI not included in the TLLI / G-RNTI field which are necessary to provide a unique identifier in <i>Iu mode</i>.</p>
<p><b><i>Iu Mode Neighbour Cell Parameters</i></b>  The <i>Iu mode Neighbour Cell Parameters</i> shall only be included when the <i>List of added Frequency struct</i> is present.</p>
<p><b><i>Iu Mode Neighbour Cell Params Struct</i></b>  This struct presents supplementary information for <i>Iu mode</i> capable cells. The struct assigns <i>Iu mode</i> parameter values to the neighbouring cells defined by the message. The <i>Iu mode Neighbour Cell params struct</i> values are assigned to the neighbouring cells in the same order they appear in the <i>List of added Frequency struct</i>.</p>
<p><b><i>NC Iu Mode Only Capable Cell List Parameters</i></b>  These parameters are used to add <i>Iu mode</i> only capable cells to BA(GPRS) list.</p>
<p><b>CELL BAR QUALIFY 3</b> (2 bit field)  This information element is defined in 3GPP TS 44.018.</p>
<p><b>3G_CCN_ACTIVE</b> (1 bit field)  This field indicates whether CCN is enabled towards 3G neighbouring cells. It is coded as follows:  <b>0</b> The broadcast 3G_CCN_ACTIVE parameter shall apply if available. Otherwise, CCN towards 3G cells is disabled in the cell.  <b>1</b> CCN towards 3G cells is enabled in the cell.</p>
<p><b>700_REPORTING_OFFSET</b> (3 bit field)  <b>700_REPORTING_THRESHOLD</b> (3 bit field)  These fields are used for measurements, as defined in 3GPP TS 45.008.  Any parameter present overwrites any old data held by the mobile station for these parameters.</p>
<p><b>810_REPORTING_OFFSET</b> (3 bit field)  <b>810_REPORTING_THRESHOLD</b> (3 bit field)  These fields are used for measurements, as defined in 3GPP TS 45.008.  Any parameter present overwrites any old data held by the mobile station for these parameters.</p>
<p><b>3G_BA_IND</b> (1 bit field)  <b>PMO_IND</b> (1 bit field)  These parameters are described in the <i>ENH Measurement Parameters</i> information element.    If either of these parameters are included also in the <i>ENH Measurement Parameters</i> information element, the values provided by the <i>ENH Measurement Parameters</i> information element shall be used.</p>

<p><b>Serving Cell Priority Parameters Description</b></p> <p>These fields are used for the inter-RAT cell re-selection algorithm based on priority, as defined in 3GPP TS 45.008. Any parameter present overwrites any old data held by the mobile station for these parameters.</p> <p>This information element is defined in sub-clause 12.51.</p>
<p><b>3G Priority Parameters Description</b></p> <p>This information element is defined in sub-clause 12.52.</p> <p>Any parameter present overwrites any old data held by the mobile station for these parameters.</p>
<p><b>E-UTRAN Parameters Description</b></p> <p>This information element is defined in sub-clause 12.53.</p>
<p><b>Individual Priorities</b></p> <p>This information element is defined in sub-clause 12.50.</p>
<p><b>3G CSG Description</b></p> <p>This information element contains the description of the 3G CSG cells. This information element is defined in sub-clause 12.54.</p>
<p><b>E-UTRAN CSG Description</b></p> <p>This information element contains the description of the E-UTRAN CSG cells. This information element is defined in sub-clause 12.55.</p>
<p><b>Measurement Control Parameters Description</b></p> <p>This information element contains the Measurement control parameters per frequency for UTRAN and E-UTRAN. This information element is defined in sub-clause 12.56.</p>
<p><b>Enhanced Cell Reselection Parameters Description</b></p> <p>This information element contains parameters for enhanced cell reselection procedures towards E-UTRAN cells, see 3GPP TS 45.008.</p> <p>This information element is defined in sub-clause 12.59.</p>
<p><b>CSG Cells Reporting Description</b></p> <p>The fields of this structure are used to signal the related parameters for measurement and reporting for CSG cells in packet transfer mode as defined in 3GPP TS 45.008. If this structure is not present, the MS shall revert to the corresponding parameters for this structure as indicated by the last received SI2quater message.</p>
<p><b>UTRAN CSG Cells Reporting Description</b></p> <p><b>UTRAN_CSG_FDD_REPORTING_THRESHOLD</b> (3 bit field)  <b>UTRAN_CSG_FDD_REPORTING_THRESHOLD_2</b> (6 bit field)  <b>UTRAN_CSG_TDD_REPORTING_THRESHOLD</b> (3 bit field)</p> <p>These fields are used to control the reporting for CSG cells as specified in 3GPP TS 45.008. If this IE is received containing none of the above fields for a given mode (FDD or TDD), the MS shall use the values of these fields from the <i>UTRAN CSG Cells Reporting Description</i> IE in the last received SI2quater within the serving cell. If no values have been received by the MS within the serving cell, the default values specified in 3GPP TS 45.008 shall apply.</p>
<p><b>E-UTRAN CSG Cells Reporting Description</b></p> <p><b>E-UTRAN_CSG_FDD_REPORTING_THRESHOLD</b> (3 bit field)  <b>E-UTRAN_CSG_FDD_REPORTING_THRESHOLD_2</b> (6 bit field)  <b>E-UTRAN_CSG_TDD_REPORTING_THRESHOLD</b> (3 bit field)  <b>E-UTRAN_CSG_TDD_REPORTING_THRESHOLD_2</b> (6 bit field)</p> <p>These fields are used to control the reporting for CSG cells as specified in 3GPP TS 45.008. If this IE is received containing none of the above fields for a given mode (FDD or TDD), the MS shall use the values of these fields from the <i>E-UTRAN CSG Cells Reporting Description</i> IE in the last received SI2quater within the serving cell. If no values have been received by the MS within the serving cell, the default values specified in 3GPP TS 45.008 shall apply.</p>

### 11.2.9b.1 GPRS REP PRIORITY description

A GPRS REP PRIORITY description construction shall be included in one and only one instance of the PACKET MEASUREMENT ORDER message within the consistent set of PACKET MEASUREMENT ORDER messages.

### 11.2.9c Packet Mobile TBF Status

This message is sent from the mobile station to the network on the uplink PACCH to indicate erroneous messages have been received relating to either a downlink or an uplink TBF.

Message type: PACKET MOBILE TBF STATUS

Direction: mobile station to network

**Table 11.2.9c.1: Packet MOBILE TBF STATUS information elements**

<pre> &lt; Packet Mobile TBF Status message content &gt; ::=   &lt; GLOBAL_TFI : &lt; Global TFI IE &gt; &gt;   &lt; TBF_CAUSE : bit (3) &gt;   { 0   1 &lt; STATUS_MESSAGE_TYPE : bit (6) &gt; }   { null   0 bit ** = &lt; no string &gt; -- Receiver compatible with earlier release       1 -- Additions in Rel-12       { 0   1 &lt; Downlink_eTFI : bit (3) &gt; }   &lt; padding bits &gt; }; </pre>
---

**Table 11.2.9c.2: Packet MOBILE TBF STATUS information element details**

<p><b>Global TFI IE</b> This information element contains the TFI of the mobile station's downlink TBF or uplink TBF. This field is defined in sub-clause 12.10.</p> <p><b>TBF_CAUSE</b> (3 bit field) The TBF_CAUSE field indicates the error cause value of the current TBF. This field is encoded according to the following table:</p> <table> <tr> <td>Bit</td> <td></td> </tr> <tr> <td>3 2 1</td> <td></td> </tr> <tr> <td>0 0 0</td> <td>Normal event;</td> </tr> <tr> <td>0 0 1</td> <td>Status, unspecified;</td> </tr> <tr> <td>0 1 0</td> <td>Syntactically incorrect message, non-distribution part error;</td> </tr> <tr> <td>0 1 1</td> <td>Syntactically incorrect message, message escape;</td> </tr> <tr> <td>1 0 0</td> <td>Message not compatible with current protocol state.</td> </tr> </table> <p>All other values are reserved and may be interpreted "Status, unspecified".</p> <p><b>STATUS_MESSAGE_TYPE</b> (6 bit field) The STATUS_MESSAGE_TYPE field, if present, is the binary representation of the message type of the downlink RLC/MAC control message that caused the status condition. Message type values are defined in sub-clause 11.2.0.1.</p> <p><b>DOWNLINK_eTFI</b> (3 bit field) See sub-clause 11.2.48</p>	Bit		3 2 1		0 0 0	Normal event;	0 0 1	Status, unspecified;	0 1 0	Syntactically incorrect message, non-distribution part error;	0 1 1	Syntactically incorrect message, message escape;	1 0 0	Message not compatible with current protocol state.
Bit														
3 2 1														
0 0 0	Normal event;													
0 0 1	Status, unspecified;													
0 1 0	Syntactically incorrect message, non-distribution part error;													
0 1 1	Syntactically incorrect message, message escape;													
1 0 0	Message not compatible with current protocol state.													

### 11.2.9d Packet Enhanced Measurement Report

This message is sent either on the PACCH if in packet transfer mode or on an assigned block on a PDTCH, from the mobile station to the network to report enhanced measurement results. The message contains measurement results from the Network Control measurements.

Message type: PACKET ENHANCED MEASUREMENT REPORT

Direction: mobile station to network

Table 11.2.9d.1: PACKET ENHANCED MEASUREMENT REPORT message content

```

< PACKET ENHANCED MEASUREMENT REPORT message content > ::=
  < TLLI / G-RNTI : bit (32) >
  { < NC Measurement Report : < NC Measurement Report struct > > }
  { null | 0 bit ** = < no string > -- Receiver compatible with earlier release
    | 1 -- Additions in Rel-5 :
      { 0 | 1 < G-RNTI extension : bit (4) > }
      { null | 0 bit ** = < no string > -- Receiver compatible with earlier release
        | 1 -- Additions in Rel-8 :
          < BITMAP_LENGTH : bit(7) >
          { 0 | 1 < REPORTING_QUANTITY : bit (6) > } * (val(BITMAP_LENGTH + 1) )
          { 0 | 1 < E-UTRAN Measurement Report : < E-UTRAN Measurement Report struct > > }
          { null | 0 bit ** = < no string > -- Receiver compatible with earlier release
            | 1 -- Additions in Rel-9 :
              { 0 | 1 < UTRAN CSG Measurement Report : < UTRAN CSG Measurement Report IE > > }
              { 0 | 1 < E-UTRAN CSG Measurement Report : < E-UTRAN CSG Measurement Report IE > > }
              { null | 0 bit ** = < no string > -- Receiver compatible with earlier release
                | 1 -- Additions in Rel-11 :
                  < SI23_BA_USED : bit >
                < padding bits > } } } } ;

< NC Measurement Report struct > ::=
  < NC_MODE : bit (1) >
  { 0 < BA_USED : bit > < 3G_BA_USED : bit >
    | 1 < PSI3_CHANGE_MARK : bit(2) > }
  < PMO_USED : bit >
  < BSIC_Seen : bit >
  < SCALE : bit >
  { 0 | 1 < Serving cell data : < Serving cell data struct > > }
  { 1 < Repeated Invalid_BSIC_Information : < Repeated Invalid_BSIC_Information struct > > } ** 0
  { 0 | 1 { 0 | 1 < REPORTING_QUANTITY : bit (6) > } ** } ; -- bitmap type reporting

< Serving cell data struct > ::=
  < RXLEV_SERVING_CELL : bit (6) >
  0 ; -- The value '1' was allocated in an earlier version of the protocol and shall not be used.

< Repeated Invalid_BSIC_Information struct > ::=
  < BCCH-FREQ-NCELL : bit (5) >
  < BSIC : bit (6) >
  < RXLEV-NCELL : bit (6) > ;

< E-UTRAN Measurement Report struct > ::=
  < N_E-UTRAN: bit (2) >
  { < E-UTRAN_FREQUENCY_INDEX : bit (3) >
    < CELL_IDENTITY : bit (9) >
    < REPORTING_QUANTITY : bit (6) > } * (val(N_E-UTRAN + 1) ) ;

```

Table 11.2.9d.2: PACKET ENHANCED MEASUREMENT REPORT information element details

<p><b>TLLI / G-RNTI</b> (32 bit field)</p> <p>This field contains the TLLI / G-RNTI of the mobile station. This field is encoded as defined in sub-clause 12.16.</p>
<p><b>NC_MODE</b> (1 bit field)</p> <p>This field indicates if the mobile station was in mode NC1 or NC2 when sending the measurement report.</p> <p>0 Mobile station in mode NC1</p> <p>1 Mobile station in mode NC2</p>

<p><b>BA_USED</b> (1 bit field),  <b>3G_BA_USED</b> (1 bit field)  <b>PSI3_CHANGE_MARK</b> (2 bit field)</p> <p>These fields shall contain the value of the BA_IND, 3G_BA_IND and PSI3_CHANGE_MARK respectively in the messages defining the used Neighbour Cell list or E-UTRAN Neighbour Cell list.</p> <p>In case PBCCH exists, PSI3_CHANGE_MARK shall be used.  In case PBCCH does not exist, BA_USED and 3G_BA_USED shall be used.</p>
<p><b>PMO_USED</b> (1 bit field)</p> <p>This parameter shall contain the value of the PMO_IND in the PACKET CELL CHANGE ORDER or PACKET MEASUREMENT ORDER messages that has modified the used Neighbour Cell list. If no such message has been received, PMO_USED shall be set to zero.</p>
<p><b>BSIC_Seen</b> (1 bit field)</p> <p>This parameters indicates if a GSM cell with invalid BSIC and allowed NCC part BSIC is one of the six strongest, see 3GPP TS 45.008.</p> <p><b>Bit</b></p> <p><b>0</b> No cell with invalid BSIC and allowed NCC part of BSIC is seen  <b>1</b> One cell or more with invalid BSIC and allowed NCC part of BSIC is seen</p>
<p><b>SCALE</b> (1 bit field)</p> <p>The value of this field is defined in 3GPP TS 45.008.</p>
<p><b>Serving cell reporting</b></p> <p>If the structure "serving cell data" is missing, this indicates that no valid measurement exist for the serving cell.</p> <p><b>RXLEV_SERVING_CELL</b> (6 bit field)</p> <p>This field contains the value of the RXLEV parameter for the serving cell calculated by the mobile station (see 3GPP TS 45.008). This field is encoded as the binary representation of the RXLEV parameter value defined in 3GPP TS 45.008.  Range 0 to 63</p>
<p><b>Neighbour cell reporting</b></p> <p><b>Repeated Invalid BSIC</b>  This structure contains the report of cells with invalid BSIC.  <b>BCCH-FREQ-NCELL</b> (5 bits). This field represents the index of the BA(GPRS), see 3GPP TS 44.018.  <b>BSIC</b> (6 bits). Base station identity code of the corresponding index in the BA(GPRS).  <b>RXLEV</b> (6 bits). GSM reporting quantity, see 3GPP TS 45.008.</p> <p><b>Bitmap type reporting:</b>  This structure contains the report of cells with valid BSIC.  Each bit of the bitmap points to the corresponding index of the Neighbour Cell list defined in sub-clause 5.6.3.3 ("Deriving the Neighbour Cell list from the GSM Neighbour Cell list and the 3G Neighbour Cell list").</p> <p>If this structure is present and more bits than needed are available at the end of the message, the MS shall set the value of the redundant bitmap positions to '0'.</p> <p>At least 96 neighbour cell entries shall be encoded in the bitmap.</p> <p>If this structure is present, some remaining bits indicating no report at the end of the message may be omitted if these bits do not fit into the message. This shall not lead to an error in the receiver of that message.</p> <p>If E-UTRAN neighbour cells are to be reported, then this structure shall be omitted and replaced by the bitmap reporting structure in the release-8 extension of this message.</p> <p><b>REPORTING_QUANTITY</b> (6 bits):  Measurement quantities are defined in 3GPP TS 45.008.</p>

<p><b>G-RNTI extension</b> (4 bit field)</p> <p>This field contains the extra 4 bits of the G-RNTI not included in the TLLI / G-RNTI field which are necessary to provide a unique identifier in <i>Iu mode</i>.</p>
<p><b>E-UTRAN Neighbour cell reporting</b></p> <p><b>BITMAP_LENGTH</b> (7 bit field)</p> <p>1+val(BITMAP_LENGTH) indicates the number of entries in the reporting bitmap.</p> <p><b>Bitmap type reporting:</b></p> <p>This structure contains the report of cells with valid BSIC. Each bit of the bitmap points to the corresponding index of the Neighbour Cell list defined in sub-clause 5.6.3.3 ("Deriving the Neighbour Cell list from the GSM Neighbour Cell list and the 3G Neighbour Cell list").</p> <p><b>REPORTING_QUANTITY</b> (6 bits):</p> <p>Measurement quantities are defined in 3GPP TS 45.008.</p>
<p><b>E-UTRAN Measurement Report</b></p> <p>This information element contains the measurement reports for one or more E-UTRAN neighbour cell. This field is defined in sub-clause 11.2.9.</p>
<p><b>UTRAN CSG Measurement Report</b></p> <p>Measurement reporting for UTRAN CSG cells is defined in 3GPP TS 45.008. This information element contains the measurement results and routing parameters for one UTRAN CSG or hybrid cell. It is defined in sub-clause 12.61.</p>
<p><b>E-UTRAN CSG Measurement Report</b></p> <p>Measurement reporting for E-UTRAN CSG cells is defined in 3GPP TS 45.008. This information element contains the measurement results and routing parameters for one E-UTRAN CSG or hybrid cell. It is defined in sub-clause 12.60.</p>
<p><b>SI23_BA_USED</b> (1 bit field)</p> <p>This field contains the value of the SI 23_BA_IND field in the SYSTEM INFORMATION TYPE 23 message defining the E-UTRAN Neighbour Cell list used. In the case SYSTEM INFORMATION TYPE 23 message is not broadcast in the cell or if the mobile station does not support network sharing this field shall be set to 0. Range 0 to 1.</p>

### 11.2.9e Packet Neighbour Cell Data

This optional message is sent by the network on the PACCH to provide system information required for initial access in a neighbouring cell. This message shall not be segmented across more than one RLC/MAC control block. If not all information fits into one instance of the PACKET NEIGHBOUR CELL DATA message, the message can be repeated.

Message type: PACKET NEIGHBOUR CELL DATA

Direction: network to mobile station

Classification: non distribution message

Table 11.2.9e.1: Packet Neighbour Cell Data information elements

```

< Packet Neighbour Cell Data message content > ::=
  < PAGE_MODE : bit (2) >
  { 0 < Global TFI : < Global TFI IE > >

    {
      < CONTAINER_ID : bit (2) >
      < spare : bit (1) >
      < CONTAINER_INDEX : bit (5) >
      { 0 | 1 < ARFCN : bit (10) >
        < BSIC : bit (6) > }
      < CONTAINER : < Container repetition struct > >
      < padding bits >
      ! < Non-distribution part error : bit (*) = < no string > > }
      ! < Address information part error : bit (*) = < no string > > }
      ! < Distribution part error : bit (*) = < no string > > ;

< Container repetition struct > ::=
  {
    {
      < PD : bit (3) >
      < CD_LENGTH : { bit (5) exclude 00000 exclude 11111 } >
      < CONTAINER_DATA : octet (val(CD_LENGTH)) > -- Final container segment. Next container follows.

    |
      < PD : bit (3) >
      < CD_LENGTH : { bit (5) == 11111 } >
      < CONTAINER_DATA : octet ** > ** -- Container continued in next message.

    {
      < spare bit (3) > -- Repetition of the container repetition struct continues until:
      < CD_LENGTH : { bit (5) == 00000 } > } -- A) val(CD_LENGTH) = 0 or
  } // ; -- B) end of PNCD message.

```

Table 11.2.9e.2: Packet Neighbour Cell Data information element details

<p>The Packet Neighbour Cell Data message consists of up to 32 instances and contains neighbour cell system information messages from either the BCCH or from the PBCCH or from both. Each container repetition struct contains information from one or more SI/PSI message. One SI/PSI message can be distributed over more than one instance.</p> <p>A container may have the cell identity represented by the ARFCN and BSIC included.</p>	
<b>PAGE_MODE</b> (2 bit field)	This field is defined in sub-clause 12.20 and gives the PAGE_MODE parameter valid in the serving cell.
<b>Global TFI</b>	This information element contains the TFI of the mobile station's downlink TBF or uplink TBF. This field is defined in sub-clause 12.10.
<b>CONTAINER_ID</b> (2 bit field)	This field contains the Container identity and shall have the same value in all instances to form a complete set of neighbour cell system information for a certain cell. Value range: 0-3.
<b>Spare</b> (1 bit field)	This bit is reserved for future use.
<b>CONTAINER_INDEX</b> (5 bit field)	This field contains the message index within a complete set of neighbour cell system information for a certain cell Value range: 0-31.

<p><b>ARFCN and BSIC</b> ARFCN and BSIC is optional, but if included their value shall be same in all instances forming a complete set. If not the same, the mobile station shall act as described in sub-clause 8.8.1.</p> <p><b>ARFCN</b> (10 bit field) This field indicates the ARFCN of the BCCH of the neighbour cell for which the information contained in this message is valid for. This field is encoded as the ARFCN defined in 3GPP TS 44.018. Range 0 to 1023</p> <p><b>BSIC</b> (6 bit field) This field indicates the BSIC of the neighbour cell for which the information contained in this message is valid.  This field is encoded as the BSIC value defined in 3GPP TS 44.018. Range 0 to 63</p>
<p><b>PD</b> (3 bit field) This field contains a protocol discriminator and indicates the origin of the contained message. bit 2 1 0 0 0      BCCH (LAPDm); 0 0 1      PBCCH (RLC/MAC); 0 1 0      Reserved; If received the contents of the container shall be discarded. ..... 1 1 1      Reserved;. If received the contents of the container shall be discarded.</p>
<p><b>CD_LENGTH</b> (5 bit field) This field indicates the number of CONTAINER DATA octets that forms a specific SI/PSI message and is coded as shown below.  bit 5 4 3 2 1 0 0 0 0 0      No CONTAINER DATA follows; Spare padding is used to fill the rest of the message; 0 0 0 0 1      CONTAINER DATA length = 1 octet; .... 1 0 0 1 0      CONTAINER DATA length = 18 octets; 1 1 1 1 1      The remaining portion of the Packet Neighbour Cell Data message is used by the associated CONTAINER DATA. The message continues in a subsequent instance of the Packet Neighbour Cell Data message, in the next CONTAINER DATA with the same Protocol Discriminator value as the current one.  All other values reserved. If a reserved value is received the contents of the container shall be discarded.</p>
<p><b>CONTAINER_DATA</b>(n*8 bits) The concatenation of one or several CONTAINER_DATA octets forms the actual contents, specific to the SI/PSI messages.  If the contained system information messages are copied from the BCCH the information contained in the Packet Neighbour Cell Data message shall exclude the following information elements from the beginning of the messages: L2 Pseudo Length; RR management Protocol Discriminator and Skip Indicator.  If the contained system information messages are copied from the PBCCH the information contained in the Packet Neighbour Cell Data message shall include the complete PSI message.  Extra octets of padding bits at the end of the SI/PSI messages may be excluded.</p>

### 11.2.10 Packet Paging Request

This message is sent on the PCCCH by the network to trigger channel access by up to four mobile stations, for either TBF or RR connection establishment. It may also be sent on PACCH to a mobile station in packet transfer mode to indicate page request for RR connection establishment. The mobile stations are identified by either IMSI, TMSI, P-TMSI or G-RNTI. Depending on the method used to identify the mobile station, 1 - 4 mobile stations can be addressed



in the message. The PACKET PAGING REQUEST message may also be used to send MBMS (pre-)notifications. Special requirements for the transmission of this message on PACCH applies, see 3GPP TS 45.002. The PACKET PAGING REQUEST message may also be used to broadcast an ETWS Primary Notification message on the PCCCH. If not all information fits into one instance of the PACKET PAGING REQUEST message, the PACKET PAGING REQUEST message can be repeated.

Message type: PACKET PAGING REQUEST

Direction: network to mobile station

Classification: distribution message

Table 11.2.10.1: PACKET PAGING REQUEST message content

```

< Packet Paging Request message content > ::=
< PAGE_MODE : bit (2) >
{ 0 | 1 < PERSISTENCE_LEVEL : bit (4) > * 4 }
{ 0 | 1 < NLN(PPCH) : bit (2) > }
{ { 1 < Repeated Page info : < Repeated Page info struct > > } ** 0
  { null
    | 0 bit** = < no string >          -- Receiver compatible with earlier release
    | 1                                -- REL-5 additions:
      { 1 < Repeated lu Page info : < Repeated lu Page info struct > > } ** 0
        { null | 0 bit** = < no string >          -- Receiver compatible with earlier release
          | 1                                -- REL-6 additions:
            { 0 | 1 < MBMS Information > }
            { 0 | 1 < NLN status(PPCH) : bit (1) > }
            { null | 0 bit** = < no string >          -- Receiver compatible with earlier release
              | 1                                -- REL-8 additions:
                { 0 | 1 < ETWS Primary Notification : < ETWS Primary Notification struct > > }
            }
          }
        }
    }
  } // -- truncation at end of message allowed, bits '0' assumed
! < Distribution part error : bit (*) = < no string > > ;

< Repeated Page info struct > ::=
{ 0                                -- Page request for TBF establishment
  { 0 < PTMSI : bit (32) >
    | 1 < Length of Mobile Identity contents : bit (4) >
      < Mobile Identity : octet (val (Length of Mobile Identity contents)) > }
  | 1                                -- Page request for RR conn. establishment
    { 0 < TMSI : bit (32) >
      | 1 < Length of Mobile Identity contents : bit (4) >
        < Mobile Identity : octet (val (Length of Mobile Identity contents)) > }
      < CHANNEL_NEEDED : bit (2) >
      { 0 | 1 < eMLPP_PRIORITY : bit (3) > } }
! < Ignore : bit (*) = < no string > > ;

< Repeated lu Page info struct > ::=
{
  { 0 < G-RNTI : bit(32) >          -- used for a CN page to an MS in RRC connected mode, or a GERAN initiated page
    { 0 | 1 < Page info struct : < Page info struct > > } -- only included for a CN page
  | 1
    { 00 < TMSI : bit (32) >
      | 01 < PTMSI : bit (32) >
      | 11 { < Length of Mobile Identity contents : bit (4) >
          < Mobile Identity : octet (val (Length of Mobile Identity contents)) > }
        < Page info struct : < Page info struct > > }
    { 0 | 1 < eMLPP_PRIORITY : bit (3) > } }
! < Ignore : bit (*) = < no string > > ;

< MBMS Information > ::=
{
  -- Pre-notifications
  < MBMS Sessions List : < MBMS Sessions List IE > >

  -- Notifications: listed per MBMS Channel Parameters
  { 1 < MBMS Channel Parameters : < MBMS Channel Parameters IE > >
    < MBMS Sessions List : < MBMS Sessions List IE > > ** 0 } }
! < Ignore : bit (*) = < no string > > ;

< Page info struct > ::=
< PAGING CAUSE : bit (3) >
< CN DOMAIN IDENTITY : bit (2) >
{ 0 | 1 < Paging Record Type Identifier : bit (2) > }; -- This field is only included if the MS is paged using a G-RNTI

```

```

< ETWS Primary Notification struct > ::=
{0 -- First segment of ETWS Primary Notification, number of segments included
  < Total No Of Segments For ETWS Primary Notification : bit (4) >
|1 -- Not first segment, segment number included
  < Segment Number : bit (4) >
}
< PNI: bit (1) > -- identifier for segments belonging to one and the same ETWS Primary Notification message
< Length Of Segment : bit (7) > -- length of segment in bits
< ETWS Primary Notification Data : bit (val(Length of segment)) >;

```

Table 11.2.10.2: PACKET PAGING REQUEST information element details

<p><b>PAGE_MODE</b> (2 bit field) This field is defined in sub-clause 12.20.</p>
<p><b>PERSISTENCE_LEVEL</b> (4 bit field for each Radio Priority 1...4) This field is defined in sub-clause 12.14, PRACH Control Parameters.</p>
<p><b>NLN(PPCH)</b> (2 bit field) Notification List Number - This field may only be present if the message contains at least one page request for an RR connection establishment. The presence of the <i>NLN(PPCH)</i> field indicates that if an NCH is present, reduced NCH monitoring can be used, and gives the <i>NLN(PPCH)</i> value, to be used as specified in 3GPP TS 44.018. The field is coded as defined in the P1 Rest Octets information element in 3GPP TS 44.018.</p> <p><b>NLN status(PPCH)</b> (1 bit field) Notification List Number status - This field may only be present if the message contains at least one page request for an RR connection establishment. The <i>NLN status</i> indicates the status of the content of the NOTIFICATION/NCH messages for a particular <i>NLN</i> value. A change of the <i>NLN status</i> field indicates a change of information on the NCH which is not related to new calls, as specified in 3GPP TS 44.018. The field is coded as defined in the P1 Rest Octets information element in 3GPP TS 44.018.</p>
<p><b>Repeated Page info struct</b> The Repeated Page info struct is repeated as many times as required to fulfil the number of wanted paged mobiles. If the Paging Request Message is used with only P-TMSIs or TMSIs, the field can be repeated up to four times within one message. If the Paging Request Message is used with only IMSIs, the field can be repeated up to two times within one message.</p> <p>The first bit in the Repeated Page info field indicates if this is a page request for TBF connection establishment or for RR connection establishment.</p> <p>A page request for TBF connection establishment can either be addressed with P-TMSI or IMSI.</p> <p>A page request for RR connection establishment contains a Channel Needed and optionally a Priority parameter and can either be addressed with TMSI or IMSI.</p>
<p><b>PTMSI</b> (32 bit field) The Packet Temporary Mobile Station Identity (PTMSI) is defined in 3GPP TS 23.003. This field is encoded as a binary number. Range 0 to 4294967295</p>
<p><b>Mobile Identity</b> (variable length octet string) This octet string is the representation of the <i>Mobile Identity</i>. It shall provide the international mobile subscriber identity, IMSI. The encoding of this octet string is the <i>value part</i> (starting with octet 3) of the type 4 information element <i>Mobile Identity</i> defined in 3GPP TS 44.018.</p> <p>Any value other than IMSI for the type of identity in this octet string is spare. Such mobile identity shall be disregarded by the receiver but any further occurrence of the Repeated Page Info struct in the message shall be analysed.</p>
<p><b>TMSI</b> (32 bit field) TMSI is a unique Temporary Mobile Subscriber Identity. TMSI is associated with the mobile subscriber and defined in 3GPP TS 23.003. This field is coded as a binary number. Range 0 to 4294967295</p>

**CHANNEL\_NEEDED** (2 bit field)

The channel needed field indicates which type of channel is needed for the mobile station for the transaction linked to the paging procedure. The field is coded according to following table:

bit	
2 1	
0 0	Any channel
0 1	SDCCH
1 0	TCH/F (Full rate)
1 1	TCH/H or TCH/F (Dual rate)

**eMLPP\_PRIORITY** (3 bit field)

The optional eMLPP\_PRIORITY field relates to Mobile Station Identity  $i$  ( $i = 1, 2, 3, 4$ ) and may only be present when the page relates to a paging request to trigger RR/RRC connection establishment. The eMLPP\_PRIORITY field is coded as the Priority field defined in the P1 Rest Octets information element in 3GPP TS 44.018.

**Repeated MBMS Notification info struct**

The Repeated MBMS Notification info struct is repeated as many times as required to fulfil the number of wanted paged Temporary Mobile Groups.

The MBMS session identity is optional and shall be included whenever being made available in the MBMS-SESSION-START-REQUEST PDU or in the MBMS-SESSION-UPDATE-REQUEST PDU received from the SGSN.

If no counting should take place then a MBMS p-t-m channel description may be included.

If counting is requested then a MPRACH description may be included.

**MBMS Sessions List**

This information element contains a list of MBMS sessions identified by their TMGI and if available MBMS Session Identity. This information element is defined in sub-clause 12.39.

**MBMS Channel Parameters**

This information element contains the MBMS channel parameters of one or more MBMS sessions. This information element is defined in sub-clause 12.36.

**Page info struct**

This struct contains all information to be passed between RLC/MAC and RRC in the MS.

**Repeated Iu\_Page info struct**

The Repeated Iu\_Page info struct is repeated as many times as required to fulfil the number of wanted paged mobiles. If the PACKET PAGING REQUEST message is used with only P-TMSIs, TMSIs or G-RNTIs, the field can be repeated up to four times within one message. If the Paging Request Message is used with only IMSIs, the field can be repeated up to two times within one message.

**G-RNTI** (32 bits)

The G-RNTI field identifies the MS within GERAN when an RRC connection exists between this MS and GERAN. G-RNTI is defined in 3GPP TS 44.118.

**PAGING RECORD TYPE IDENTIFIER** (2 bits field)

The Paging Record Type Identifier field indicates the type of identity used in the core network page, as it is defined in 3GPP TS 44.118. This field shall be included in the message if the MS is identified in the page with a G-RNTI

bit	
2 1	
0 0	IMSI (GSM-MAP)
0 1	TMSI (GSM-MAP) / P-TMSI
1 0	IMSI (DS-41)
1 1	TMSI (DS-41)

**CN DOMAIN IDENTITY** (2 bit field)

The CN Domain Identity field indicates the domain of the core network from which the MS is paged, as defined in 3GPP TS 44.118.

Bit	
2 1	
0 0	CS domain
0 1	PS domain
1 0	Either
1 1	Reserved

**PAGING CAUSE** (3 bits field)

The Paging Cause field indicates the cause for paging, as defined in 3GPP TS 44.118.

bit	
3 2 1	
0 0 0	Terminating Conversational Call
0 0 1	Terminating Streaming Call
0 1 0	Terminating Interactive Call
0 1 1	Terminating Background Call
1 0 0	Terminating High Priority Signalling
1 0 1	Terminating Low Priority Signalling
1 1 0	Terminating - cause unknown
1 1 1	Reserved

**Total No Of Segments For ETWS Primary Notification** (4 bits)

This field contains the number of segments for the ETWS Primary Notification message.

Bits	
4 3 2 1	
0 0 0 0	reserved
0 0 0 1	one segment
0 0 1 0	two segments
. . .	
0 0 1 0	fifteen segments

**Segment Number** (4 bits)

This field contains the Segment Number of the ETWS Primary Notification message.

Bits	
4 3 2 1	
0 0 0 0	reserved
0 0 0 1	reserved
0 0 1 0	second segment
0 0 1 1	third segment
. . .	
0 0 1 1	fifteenth segment

**PNI, Primary Notification Identifier** (1 bit)

This field is used as an identifier to determine the set of segments belonging to a certain ETWS Primary Notification message. This information element will have the same value (0 or 1) for all segments belonging to the same ETWS Primary Notification message.

**Length Of Segment** (7 bits)

This field indicates the length of a segment in number of bits.

**ETWS Primary Notification Data** (n\*8 bits)

The ETWS Primary Notification data is coded as specified in 3GPP TS 23.041.

## 11.2.11 Packet PDCH Release

This message is sent on PACCH by the network to notify all mobile stations listening to that PDCH that one or more PDCHs will be immediately released and become unavailable for packet data traffic.

Message type: PACKET PDCH RELEASE

Direction: network to mobile station

Classification: distribution message

**Table 11.2.11.1: PACKET PDCH RELEASE information elements**

```
< Packet PDCH Release message content > ::=
  < PAGE_MODE : bit (2) >
  { 1 < TIMESLOTS_AVAILABLE : bit (8) > }
  < padding bits >
  ! < Distribution part error : bit (*) = < no string > > ;
```

**Table 11.2.11.2: PACKET PDCH RELEASE information element details**

**PAGE\_MODE** (2 bit field)

This field is defined in sub-clause 12.20.

**TIMESLOTS\_AVAILABLE** (8 bit field)

This information field indicates the timeslots assigned for GPRS use on the current MAIO or ARFCN. Bit 8 indicates the status of timeslot 0, bit 7 indicates the status of timeslot 1, etc.

- 0 Timeslot is not assigned
- 1 Timeslot is assigned

**NOTE:** If the bit preceding the parameter TIMESLOTS\_AVAILABLE is received = 0 a distribution part error should be generated by the mobile station. To allow compatibility with early GPRS mobile stations in Release 97 such mobile stations may interpret this message, if received with the bit preceding the parameter TIMESLOTS\_AVAILABLE equal to 0, as a command to release the timeslot on which the message was received.

## 11.2.12 Packet Polling Request

This message is sent on the PCCCH or PACCH by the network to the mobile station to solicit a PACKET CONTROL ACKNOWLEDGEMENT message from the mobile station.

Message type: PACKET POLLING REQUEST

Direction: network to mobile station

Classification: non-distribution message

Table 11.2.12.1: PACKET POLLING REQUEST information elements

<pre> &lt; Packet Polling Request message content &gt; ::=   &lt; PAGE_MODE : bit (2) &gt;   {     { 0 &lt; Global TFI : &lt; Global TFI IE &gt; &gt;         10 &lt; TLLI / G-RNTI : bit (32) &gt;         110 &lt; TQI : bit (16) &gt; }     { &lt; TYPE_OF_ACK : bit (1) &gt;       { null   0 bit ** = &lt; no string &gt; -- Receiver compatible with earlier release           1 -- Additions in Rel-5 :           { 0   1 &lt; G-RNTI extension : bit (4) &gt; }           &lt; padding bits &gt; }       ! &lt; Non-distribution part error : bit (*) = &lt; no string &gt; &gt; }       ! &lt; Address information part error : bit (*) = &lt; no string &gt; &gt; }       ! &lt; Distribution part error : bit (*) = &lt; no string &gt; &gt; ; </pre>
--

Table 11.2.12.2: PACKET POLLING REQUEST information element details

<p><b>PAGE_MODE</b> (2 bit field) This field is defined in sub-clause 12.20.</p>
<p><b>TQI</b> (16 bit field) This field is defined in sub-clause 12.17.</p>
<p><b>TLLI / G-RNTI</b> (32 bit field) This field is defined in sub-clause 12.16.</p>
<p><b>Global TFI</b> This information element contains the TFI of the mobile station's downlink TBF or uplink TBF. This field is defined in sub-clause 12.10.</p>
<p><b>TYPE_OF_ACK</b> This field indicates the format of the PACKET CONTROL ACKNOWLEDGEMENT message requested from the mobile station by the PACKET POLLING REQUEST message.</p> <p>0 PACKET CONTROL ACKNOWLEDGEMENT message format shall be sent as four access bursts 1 PACKET CONTROL ACKNOWLEDGEMENT message format shall be an RLC/MAC control block</p>
<p><b>G-RNTI extension</b> (4 bit field) This field contains the extra 4 bits of the G-RNTI not included in the TLLI / G-RNTI field which are necessary to provide a unique identifier in <i>lu mode</i>.</p>

### 11.2.13 Packet Power Control/Timing Advance

This message is sent on PACCH by the network to the mobile station in order to update the mobile station timing advance or power control parameters.

Message type: PACKET POWER CONTROL/TIMING ADVANCE

Direction: network to mobile station

Classification: non-distribution message

**Table 11.2.13.1: PACKET POWER CONTROL/TIMING ADVANCE information elements**

```

< Packet Power Control/Timing Advance message content > ::=
  < PAGE_MODE : bit (2) >
  { 0 < Global TFI : < Global TFI IE > >
    { 0 -- Message escape
      { { 0 | 1 < Global Power Control Parameters : < Global Power Control Parameters IE >> }
        { 0 < Global Packet Timing Advance : < Global Packet Timing Advance IE > >
          < Power Control Parameters : < Power Control Parameters IE > >
        | 1 { 0 < Global Packet Timing Advance : < Global Packet Timing Advance IE > >
          | 1 < Power Control Parameters : < Power Control parameters IE > > } }
      { null | 0 bit** = < no string > -- Receiver backward compatible with earlier version
        | 1 -- Additions for R99
          { 0 | 1 < Packet Extended Timing Advance : bit (2)> }
          { null | 0 bit** = < no string > -- Receiver backward compatible with earlier version
            | 1 -- Additions for REL-7
              { 0 | 1 < Carrier Identification : bit (2) > }
              { null | 0 bit** = < no string > -- Receiver backward compatible with earlier version
                | 1 -- Additions for REL-12
                  { 0 | 1 < Carrier Count : bit (4) >
                    < DLMC Carrier Bitmap : bit (val(Carrier Count) + 1) }
                }
            }
          }
      }
    }
  }
  ! < Non-distribution part error : bit (*) = < no string > > }
  ! < Message escape : 1 bit (*) = < no string > > }
  ! < Address information part error : bit (*) = < no string > > }
  ! < Distribution part error : bit (*) = < no string > > ;

```

**Table 11.2.13.2: PACKET POWER CONTROL/TIMING ADVANCE information element details**

<p><b>Global Power Control Parameters IE</b> This information field is defined in sub-clause 12.9.</p> <p><b>Global Packet Timing Advance IE</b> This information field is defined in sub-clause 12.12a.</p> <p><b>Power Control Parameters IE</b> This information element contains the power control parameters the mobile station shall use to determine its TX power level. If this information element does not include the updated power control parameters for some of currently assigned timeslots, the MS shall continue to use the current power control parameters for these timeslots. This information field is defined in sub-clause 12.13.</p> <p><b>Global TFI IE</b> This information element contains the TFI of the mobile station's downlink TBF or uplink TBF. This field is defined in sub-clause 12.10.</p> <p><b>Packet Extended Timing Advance (2 bit field)</b> This field is defined in sub-clause 12.12b.</p>
<p><b>Carrier Identification (2 bit field)</b> This field identifies the carrier to which the Power Control Parameters refers.</p> <p>bit</p> <p>0 0 Power Control Parameters applies to both carriers</p> <p>0 1 Power Control Parameters applies to carrier 1</p> <p>1 0 Power Control Parameters applies to carrier 2</p> <p>1 1 Reserved for future use</p>



**DLMC Carrier Bitmap** (1 - 16 bit field)

This field identifies the carrier(s) to which the Power Control Parameters are applicable for a DLMC configuration. In the absence of this field the MS shall assume the Power Control Parameters applies to all downlink carriers assigned for the DLMC configuration.

The most significant bit of this bitmap (bit N) refers to the lowest number carrier in the DLMC configuration and the least significant bit of this bitmap (bit 1) refers to the highest number carrier in the DLMC configuration. Each bit position in this bitmap is coded as follows:

- 0 The Power Control Parameters are not applicable
- 1 The Power Control Parameters are applicable

## 11.2.14 Packet PRACH Parameters

This message is sent on the PCCCH by the network to all mobile stations within the cell to update the PRACH parameters in between Packet System Information messages containing PRACH parameters.

Message type: PACKET PRACH PARAMETERS

Direction: network to mobile station

Classification: distribution message

**Table 11.2.14.1: PACKET PRACH PARAMETERS information elements**

```
< Packet PRACH Parameters message content > ::=
  < PAGE_MODE : bit (2) >
  < PRACH Control Parameters : < PRACH Control Parameters IE > >
  < padding bits >
  ! < Distribution part error : bit (*) = < no string > > ;
```

**Table 11.2.14.2: PACKET PRACH PARAMETERS information element details**

**PAGE\_MODE** (2 bit field)

This field is defined in sub-clause 12.20.

**PRACH Control Parameters**

This information element is defined in sub-clause 12.14.

## 11.2.15 Packet Queuing Notification

This message is sent on the PCCCH by the network to the mobile station to notify the mobile station that it is being placed in queue. The message allocates a Temporary Queuing Identity to the mobile station.

Message type: PACKET QUEUING NOTIFICATION

Direction: network to mobile station

Classification: non-distribution message

**Table 11.2.15.1: PACKET QUEUING NOTIFICATION information elements**

<pre> &lt; Packet Queueing Notification message content &gt; ::=   &lt; PAGE_MODE : bit (2) &gt;   {     111 &lt; Packet Request Reference : &lt; Packet Request Reference IE &gt; &gt;     {       &lt; TQI : bit (16) &gt;       &lt; padding bits &gt;       ! &lt; Non-distribution part error : bit (*) = &lt; no string &gt; &gt; }       ! &lt; Address information part error : bit (*) = &lt; no string &gt; &gt; }     }   ! &lt; Distribution part error : bit (*) = &lt; no string &gt; &gt; ; </pre>
---

**Table 11.2.15.2: PACKET QUEUING NOTIFICATION information element details**

<p><b>PAGE_MODE</b> (2 bit field) This field is defined in sub-clause 12.20.</p> <p><b>Packet Request Reference</b> This information element is defined in sub-clause 12.11.</p> <p><b>TQI</b> (16 bit field) This information field is defined in sub-clause 12.17.</p>
--

## 11.2.16 Packet Resource Request

This message is sent on the PACCH by the mobile station to the network to request a change in the uplink resources assigned.

Message type: PACKET RESOURCE REQUEST

Direction: mobile station to network



<p><b>ACCESS_TYPE</b> (2 bit field)</p> <p>This field indicates the reason for requesting the access. It shall be included only in response to a single block or Multi block assignment.</p> <p>bit</p> <p>2 1</p> <p>0 0 Two Phase Access Request</p> <p>0 1 Page Response</p> <p>1 0 Cell Update</p> <p>1 1 Mobility Management procedure</p>
<p><b>TLLI / G-RNTI</b></p> <p>This information element is defined in sub-clause 12.16.</p>
<p><b>MS Radio Access Capability 2</b></p> <p>This information element is defined in sub-clause 12.30. This information element is sent only during two phase access and shall not be include by MS operating in <i>Iu mode</i>. Additionally, this information element shall be sent in one phase EGPRS TBF establishment procedure if ordered by the network.</p>
<p><b>Channel Request Description</b></p> <p>This information element is defined in sub-clause 12.7. If a PFI field is included in this message, it relates to the TBF request contained in the <i>Channel Request Description</i> IE. If the <i>Extended Channel Request Description</i> IE is included in this message, the value of this IE (and the PFI field) shall be ignored. When a PACKET RESOURCE REQUEST message is sent in response to an Access Technologies Request received by the MS during a one phase access this IE shall be ignored.</p> <p><b>Extended Channel Request Description</b></p> <p>This information element is defined in sub-clause 12.7b. This IE contains a request for one or more additional uplink TBFs and shall only be included if the mobile station and the network support multiple TBF procedures. If this IE is included, the <i>Channel Request Description</i> IE and PFI field in the message shall be ignored.</p>
<p><b>CHANGE_MARK</b> (2 bit field)</p> <p>This field contains the PSI2_CHANGE_MARK value stored by the mobile station's if PBCCH is present in the current cell. If PBCCH is not present in the current cell, this field contains the SI13_CHANGE_MARK value stored by the mobile station. If the mobile station does not have a valid PSI2 or SI13 <i>change mark</i> for the current cell, the mobile station shall omit this field. The coding of this field is network dependent.</p>
<p><b>C_VALUE</b> (6 bit field)</p> <p>This field is encoded as the binary representation of the C value as specified in 3GPP TS 45.008. Range 0 to 63</p>
<p><b>SIGN_VAR</b> (6 bits)</p> <p>This field contains the signal variance parameter SIGN_VAR calculated by the mobile station (see 3GPP TS 45.008). This field is not present for TBF establishment using two phase access or for a TBF in EGPRS mode.</p> <p>bit</p> <p>6 5 4 3 2 1</p> <p>0 0 0 0 0 0 0dB<sup>2</sup> to 0.25 dB<sup>2</sup></p> <p>0 0 0 0 0 1 &gt;0.25 dB<sup>2</sup> to 0.50 dB<sup>2</sup></p> <p>0 0 0 0 1 0 &gt;0.50 dB<sup>2</sup> to 0.75 dB<sup>2</sup></p> <p>:::</p> <p>1 1 1 1 1 0 &gt;15.50 dB<sup>2</sup> to 15.75 dB<sup>2</sup></p> <p>1 1 1 1 1 1 &gt;15.75 dB<sup>2</sup></p>

<p><b>I_LEVEL_TN0</b> (4 bit field)  <b>I_LEVEL_TN1</b> (4 bit field)  <b>I_LEVEL_TN2</b> (4 bit field)  <b>I_LEVEL_TN3</b> (4 bit field)  <b>I_LEVEL_TN4</b> (4 bit field)  <b>I_LEVEL_TN5</b> (4 bit field)  <b>I_LEVEL_TN6</b> (4 bit field)  <b>I_LEVEL_TN7</b> (4 bit field)</p> <p>For element definition see sub-clause 11.2.6 - Packet Downlink Ack/Nack. These fields shall not be present if they are included in the EGPRS Timeslot Link Quality Measurements IE.</p>
<p><b>EGPRS BEP Link Quality Measurements</b></p> <p>This information element is defined in sub-clause 12.5.3. This IE is transferred if it is available and if it would not cause the message to expand beyond one RLC/MAC control block and if the PACKET RESOURCE REQUEST is sent during on-going concurrent EGPRS TBF.</p>
<p><b>EGPRS Timeslot Link Quality Measurements</b></p> <p>This information element is defined in sub-clause 12.5.4. This IE is transferred if it is available and if it would not cause the message to expand beyond one RLC/MAC control block and if the PACKET RESOURCE REQUEST is sent during on-going concurrent EGPRS TBF.</p>
<p><b>PFI</b> (7 bit field)</p> <p>This field contains the PFI parameter identifying a Packet Flow Context relating to the resource request specified in the <i>Channel Request Description</i> IE. The PFI parameter is encoded as the contents of the PFI information element as defined in 3GPP TS 44.018. This field may be included if the network supports packet flow context procedures. If the <i>Extended Channel Request Description</i> IE is included in this message, the value of this field (and the <i>Channel Request Description</i> IE) shall be ignored.</p>
<p><b>ADDITIONAL MS RAC INFORMATION AVAILABLE (1 bit field)</b></p> <p>0 indicates that the MS will not send more information about its radio access capabilities than included in this message</p> <p>1 indicates that the MS will provide more information about its radio access capabilities by sending an ADDITIONAL MS RADIO ACCESS CAPABILITIES message, either in the next radio block allocated to the mobile station on the assigned PDCH, or upon a further request from the network if the mobile station was allocated only one radio block. This value shall not be used by MS operating in <i>Iu mode</i>.</p>
<p><b>RETRANSMISSION OF PRR (1 bit field)</b></p> <p>This field indicates whether the corresponding PACKET RESOURCE REQUEST message is a retransmission. In case the PACKET RESOURCE REQUEST message is a retransmission, the message content (except this field and the address information) shall be identical to the PACKET RESOURCE REQUEST message previously sent (see sub-clause 7.1.2.2.1a).</p> <p>0 indicates that this message is an initial PACKET RESOURCE REQUEST message</p> <p>1 indicates that this message is a retransmitted PACKET RESOURCE REQUEST message; in this case the corresponding PACKET RESOURCE REQUEST message shall not be interpreted as a request for resource reassignment.</p>
<p><b>G-RNTI extension</b> (4 bit field)</p> <p>This field contains the extra 4 bits of the G-RNTI not included in the TLLI / G-RNTI field which are necessary to provide a unique identifier for contention resolution in <i>Iu-mode</i>.</p>
<p><b>HFN_LSB</b> (1 bit field)</p> <p>This field contains the least significant bit of the uplink HFN of the radio bearer for which the TBF is requested.</p>
<p><b>EARLY_TBF_ESTABLISHMENT</b> (1 bit field)</p> <p>This field indicates whether or not the packet resource request is meant to request pre-allocation of an uplink TBF:</p> <p>0 The packet resource request is not meant to pre-allocate an uplink TBF.</p> <p>1 The packet resource request is meant to pre-allocate an uplink TBF.</p>
<p><b>EGPRS BEP Link Quality Measurements Type 2</b></p> <p>This information element is defined in sub-clause 12.5a.2. This IE is transferred if it is available and if it would not cause the message to expand beyond one RLC/MAC control block and if the PACKET RESOURCE REQUEST is sent during on-going concurrent EGPRS2 TBF.</p>

**EGPRS Timeslot Link Quality Measurements Type 2**

This information element is defined in sub-clause 12.5a.3. This IE is transferred if it is available and if it would not cause the message to expand beyond one RLC/MAC control block and if the PACKET RESOURCE REQUEST is sent during on-going concurrent EGPRS2 TBF.

**Low Access Priority Signalling**

This field allows a mobile station to indicate whether it is requesting a packet access for the purpose of *NAS signalling low priority* (see sub-clause 7.1.3.1).

0 Indicates the PACKET RESOURCE REQUEST message is sent for requesting a packet access for a different purpose than *NAS signalling low priority*

1 Indicates the PACKET RESOURCE REQUEST message is sent for requesting a packet access for the purpose of *NAS signalling low priority*

**DOWNLINK\_eTFI** (3 bit field)

See sub-clause 11.2.48

## 11.2.17 Packet PSI Status

This message is sent on the PACCH from the mobile station to the network to indicate which PSI messages the mobile station has received.

Message type: PACKET PSI STATUS

Direction: mobile station to network

**Table 11.2.17.1: PACKET PSI STATUS information elements**

```

< Packet PSI Status message content > ::=
  < GLOBAL_TFI : < Global TFI IE > >
  < PBCCH_CHANGE_MARK : bit (3) >
  < Received PSI Message List : < PSI Message List struct > >
  < Received Unknown PSI Message List : < Unknown PSI Message List struct > >

  { null | 0 bit** = < no string >          -- Receiver backward compatible with earlier version
    | 1                                     -- Additions for REL-6 :
      < PS_REL_REQ : bit >
      < padding bits > } ;

< PSI Message List struct > ::=
  { 1 < MESSAGE_TYPE : bit (6) >
    < PSIX_CHANGE_MARK : bit (2) >
    { 0 | 1 < PSIX_COUNT : bit (4) >
      < Instance bitmap : bit (val(PSIX_COUNT) + 1) > } ** 0
    < ADDITIONAL_MSG_TYPE : bit > ;

< Unknown PSI Message List struct > ::=
  { 1 < MESSAGE_TYPE : bit (6) > } ** 0
  < ADDITIONAL_MSG_TYPE : bit > ;

```

**Table 11.2.17.2: PACKET PSI STATUS information element details**

**Global TFI** (information element)

This information element contains the TFI of the mobile station's uplink or downlink TBF.. The coding of this information element is defined in sub-clause 12.10.

**PBCCH\_CHANGE\_MARK** (3 bit field)

This field is the binary representation of the last PBCCH\_CHANGE\_MARK received in the PSI1 message on PBCCH.

<p><b>Received PSI Message List</b> (construction)</p> <p>This construction contains a list of supported PSI messages (see sub-clause 5.5.1.4.3). The sender of this message may indicate as many messages in this list as can be fit into the message. Messages are listed by message type in descending order of priority. If there are more PSI messages than can be indicated in this list, the presence of additional message type(s) shall be indicated at the end of the list.</p> <p>If the sender of this message has received a PSI message which is part of a consistent set of PSI messages (see 5.5.2.1.4), the Instance Bitmap may indicate which instances of this message type that have been received.</p> <p>Under certain circumstances, see sub-clause 5.5.1.4.3, the sender of this message may use this construction to indicate the message type of a PSI message that has not been received. In that case, the corresponding Instance Bitmap field shall be included. The PSIX_CHANGE_MARK field, PSIX_COUNT field and the one element of the Instance Bitmap field shall all be set to the value '0'.</p>
<p><b>Received Unknown PSI Message List</b> (construction)</p> <p>This construction contains a list of message types that are received on PBCCH, which are either unknown or not recognized as supported PSI message types. The sender of this message may indicate as many messages in this list as can be fit into the message following the Received PSI Message List. Messages are listed by message type in the inverse order of reception, starting with the most recently received message type. If there are more messages than can be indicated in this list, the presence of additional message type(s) shall be indicated at the end of the list.</p>
<p><b>MESSAGE_TYPE</b> (6 bit field)</p> <p>This field is the binary representation of the message type (see sub-clause 11.2.0.1).</p>
<p><b>PSIX_CHANGE_MARK</b> (2 bit field)</p> <p>This field is the binary representation of the PSI <i>change mark</i> parameter received for a certain PSI message type. Range: 0 to 3.</p>
<p><b>PSIX_COUNT</b> (4 bit field)</p> <p>This field is the binary representation of the PSI <i>count</i> parameter received for a certain PSI message type. This field indicates the length of the corresponding <i>Instance bitmap</i> field and shall be provided only if the corresponding <i>Instance bitmap</i> field is provided in the message. Range: 0 to 7 or 0 to 15, depending on message type.</p>
<p><b>Instance bitmap</b> (1 - 16 bit field)</p> <p>This field is a bitmap indicating which instances of a certain message type that are received within a consistent set of PSI messages. This field shall be included when a sub-set of these messages has been received. This field shall not be included when the complete set of these messages has been received.</p> <p>The most significant bit of this bitmap (bit N) refers to the message instance with the PSI <i>index</i> parameter = N-1, where N is the number of instances of the particular message type (PSI <i>count</i> + 1). The least significant bit of this bitmap (bit 1) refers to the message instance with the PSI <i>index</i> parameter = 0. Each bit position is coded:</p> <p>0 Message instance is not received; 1 Message instance is received.</p>
<p><b>ADDITIONAL_MSG_TYPE</b> (1 bit field)</p> <p>0 No additional message type is present. 1 Additional message type(s) are available, but this information does not fit into the message.</p>
<p><b>PS_REL_REQ</b> (1 bit field)</p> <p>This field indicates whether the mobile station requests the release of the RR connection and packet resources. This field may only be set to "1" in certain cases, see 3GPP TS 44.018. This field shall always be present in the message when the enhanced DTM CS release procedure is ongoing.</p> <p>0 The mobile station does not request the release of the RR connection and packet resources. 1 The mobile station requests the release of the RR connection and packet resources.</p>

## 11.2.17a Packet Serving Cell Data

This optional message is sent by the network on the PACCH to provide system information broadcast on the BCCH (respectively PBCCH to a mobile station. For example, several instances of this message may be sent by the network in

a cell supporting PACKET SI STATUS (respectively PACKET PSI STATUS) following the request for acquisition of system information by a mobile station. This message shall not be segmented across more than one RLC/MAC control block. If not all information fits into one instance of the PACKET SERVING CELL DATA message, the message can be repeated.

Message type: PACKET SERVING CELL DATA

Direction: network to mobile station

Classification: non-distribution message

**Table 11.2.17a.1: Packet Serving Cell Data information elements**

```

< Packet Serving Cell Data message content > ::=
  < PAGE_MODE : bit (2) >
  { 0 < Global TFI : < Global TFI IE > >
    { < spare : bit (4) >
      < CONTAINER_INDEX : bit (5) >
      < CONTAINER : < Container repetition struct > >
      < padding bits >
      ! < Non-distribution part error : bit (*) = < no string > > }
      ! < Address information part error : bit (*) = < no string > > }
      ! < Distribution part error : bit (*) = < no string > > ;
  }

< Container repetition struct > ::=
  {
    { < PD : bit (3) >
      < CD_LENGTH : { bit (5) exclude 00000 exclude 11111 } >
      < CONTAINER_DATA : octet (val(CD_LENGTH)) > -- Final container segment. Next container follows.

    | < PD : bit (3) >
      < CD_LENGTH : { bit (5) == 11111 } >
      < CONTAINER_DATA : octet ** > } ** -- Container continued in next message.

    { < spare bit (3) >
      < CD_LENGTH : { bit (5) == 00000 } > } -- Repetition continues until:
      -- A) val(CD_LENGTH) = 0 or
      -- B) end of PSCD message.
  } // ;

```

**Table 11.2.17a.2: Packet Serving Cell Data information element details**

<p>The Packet Serving Cell Data message consists of up to 32 instances and contains serving cell system information messages from the BCCH or from the PBCCH or from both. Each container repetition struct contains information from one or more SI/PSI message. One SI/PSI message can be distributed over more than one instance.</p> <p>A container can only refer to the serving cell.</p>	
<p><b>PAGE_MODE</b> (2 bit field) This field is defined in sub-clause 12.20.</p>	
<p><b>Global TFI</b> This information element contains the TFI of the mobile station's downlink TBF or uplink TBF. This field is defined in sub-clause 12.10.</p>	
<p><b>PD</b> (3 bit field) This field contains a protocol discriminator and indicates the origin of the contained message.</p>	
Bit	
2 1	
0 0 0	BCCH (LAPDm);
0 0 1	PBCCH (RLC/MAC);
0 1 0	Reserved; If received the contents of the container shall be discarded.
.....	
1 1 1	Reserved; If received the contents of the container shall be discarded.



**CD\_LENGTH** (5 bit field)

This field indicates the number of CONTAINER DATA octets that forms a specific SI/PSI message and is coded as shown below.

Bit

5 4 3 2 1

0 0 0 0 0 No CONTAINER DATA follows; Spare padding is used to fill the rest of the message;

0 0 0 0 1 CONTAINER DATA length = 1 octet;

....

1 0 0 1 0 CONTAINER DATA length = 18 octets;

1 1 1 1 1 The remaining portion of the Packet Serving Cell Data message is used by the associated CONTAINER DATA. The message continues in a subsequent instance of the Packet Serving Cell Data message, in the next CONTAINER DATA with the same Protocol Discriminator value as the current one.

All other values reserved. If a reserved value is received the contents of the container shall be discarded.

**CONTAINER\_DATA**(n\*8 bits)

The concatenation of one or several CONTAINER\_DATA octets forms the actual contents, specific to the SI/PSI messages.

If the contained system information messages are copied from the BCCH the information contained in the Packet Serving Cell Data message shall exclude the following information elements from the beginning of the messages: L2 Pseudo Length; RR management Protocol Discriminator and Skip Indicator.

If the contained system information messages are copied from the PBCCH the information contained in the Packet Serving Cell Data message shall include the complete PSI message.

Extra octets of padding bits at the end of the SI/PSI messages may be excluded.

## 11.2.17b Packet SI Status

This message is sent on the PACCH from the mobile station to the network to indicate which SI messages the mobile station has received.

Message type: PACKET SI STATUS

Direction: mobile station to network

Table 11.2.17b.1: PACKET SI STATUS information elements

```

< Packet SI Status message content > ::=
  < GLOBAL_TFI : < Global TFI IE > >
  < BCCH_CHANGE_MARK : bit (3) >
  < Received SI Message List : < SI Message List struct > >
  < Received Unknown SI Message List : < Unknown SI Message List struct > >

  { null | 0 bit** = < no string >      -- Receiver backward compatible with earlier version
  | 1                                     -- Additions for REL-6 :
    < PSCSI_SUPPORT : bit >
    < PS_REL_REQ : bit >
    < padding bits > } ;
< SI Message List struct > ::=
  { 1 < SI_MESSAGE_TYPE : bit (8) >
    { < MESS_REC : bit (2) == 00 > < null > -- Message type supported but not received
    | < MESS_REC : bit (2) == 01 > < null > -- Message type supported and received, single instance
    | < MESS_REC : bit (2) == 10 >          -- Message type supported and partially received, multiple instances
      < SIX_CHANGE_MARK : bit (3) >
      < SIX_COUNT : bit (4) >
      < Instance bitmap : bit (val(SIX_COUNT) + 1) >
    | < MESS_REC : bit (2) == 11 >          -- Message type supported and completely received, multiple
      instances
      < SIX_CHANGE_MARK : bit (3) > }
  } ** 0
  < ADDITIONAL_MSG_TYPE : bit > ;
< Unknown SI Message List struct > ::=
  { 1 < SI_MESSAGE_TYPE : bit (8) > } ** 0
  < ADDITIONAL_MSG_TYPE : bit > ;

```

Table 11.2.17b.2: PACKET SI STATUS information element details

<p><b>Global TFI</b> (information element)</p> <p>This information element contains the TFI of the mobile station's uplink or downlink TBF. The coding of this information element is defined in sub-clause 12.10.</p>
<p><b>BCCH_CHANGE_MARK</b> (3 bit field)</p> <p>This field is the binary representation of the last BCCH_CHANGE_MARK received in the SI13 message on BCCH or PACCH.</p>
<p><b>Received SI Message List</b> (construction)</p> <p>This construction contains a list of supported SI messages (see sub-clause 5.5.1.4.3). The sender of this message may indicate as many messages in this list as can be fit into the message. Messages are listed by message type in descending order of priority. If there are more SI messages than can be indicated in this list, the presence of additional message type(s) shall be indicated at the end of the list.</p> <p>If the sender of this message has received an SI message which is part of a consistent set of SI messages (see sub-clause 5.5.2.1.4), the Instance Bitmap may indicate which instances of this message type that have been received.</p>
<p><b>Received Unknown SI Message List</b> (construction)</p> <p>This construction contains a list of message types that are received on BCCH, which are either unknown or not recognised as supported SI message types. The sender of this message may indicate as many messages in this list as can be fit into the message following the Received SI Message List. Messages are listed by message type in the inverse order of reception, starting with the most recently received message type. If there are more messages than can be indicated in this list, the presence of additional message type(s) shall be indicated at the end of the list.</p>
<p><b>SI_MESSAGE_TYPE</b> (8 bit field)</p> <p>This field is the binary representation of the message type of the indicated SI message (see 3GPP TS 24.007 and 3GPP TS 44.018).</p>

**MESS\_REC** (2 bit field)

This field indicates for each message type that is supported by the mobile station whether one or more instances of the message have been received. The field is coded:

Bit

2 1

0 0 The message type is supported but not received;

0 1 The message type is supported and received; this type of SI message does not exist in multiple instances;

1 0 The message type is supported and instances of the message with the indicated change mark are partially received;

1 1 The message type is supported and all instances of the message are received with the indicated change mark.

**SIX\_CHANGE\_MARK** (3 bit field)

This field is the binary representation of the SI change mark parameter received for a certain SI message type, except for the SI2ter, the SI2quater and the SI15 message types. For the SI2ter, SI2n,, SI18, SI19 and SI20 messages, the range is: 0 to 3. For the SI2quater and SI15 messages, the range is: 0 to 7.

For the SI2ter message type, the three bits are used according to the following principles:

SI2ter

Bit

3 2 1

0 - X Bit 1: SI2ter\_3G\_CHANGE\_MARK

0 X - Bit 2: SI2ter\_MP\_CHANGE\_MARK.

For the SI2quater message type, the mobile station shall include the latest received values of the BA\_IND, 3G\_BA\_IND and MP\_CHANGE\_MARK fields. The field is coded as follows:

Bit

3 2 1

- - X Bit 1: MP\_CHANGE\_MARK

- X - Bit 2: 3G\_BA\_IND

X - - Bit 3: BA\_IND

For the SI15 message type, the mobile station shall include the three least significant bits of the DM\_CHANGE\_MARK parameter (i.e., DM\_CHANGE\_MARK modulo 8).

**SIX\_COUNT** (4 bit field)

This field is the binary representation of the SI *count* parameter received for a certain SI message type. This field indicates the length of the corresponding *Instance bitmap* field and shall be provided only if the corresponding *Instance bitmap* field is provided in the message.

For SI18, SI19 and SI20 messages, this field shall be set to 7 if present.

For the SI15 message the range is 0 to 3.

For the SI2ter message the range is 0 to 7.

For the SI2quater message the range is 0 to 15.

For the SI2n message the range is 0 to 15.

**Instance bitmap** (1 - 16 bit field)

This field is a bitmap indicating which instances of a certain message type that are received within a consistent set of SI messages. This field shall be included when a sub-set of these messages has been received. This field shall not be included when the complete set of these messages has been received.

The most significant bit of this bitmap (bit N) refers to the message instance with the *SIX index* parameter = N-1, where N is the number of instances of the particular message type (*SIX count* + 1). The least significant bit of this bitmap (bit 1) refers to the message instance with the *SI index* parameter = 0. Each bit position is coded:

0 Message instance is not received;

1 Message instance is received.

<p><b>ADDITIONAL_MSG_TYPE</b> (1 bit field)</p> <p>0 No additional message type is present.</p> <p>1 Additional message type(s) are available, but this information does not fit in to the message.</p>
<p><b>PSCSI_SUPPORT</b> (1 bit field)</p> <p>0 PACKET SERVING CELL SI message not supported</p> <p>1 PACKET SERVING CELL SI message supported</p> <p>The MS shall set the PSCSI_SUPPORT bit to "1" in this revision of the specification. This field shall always be present in the PACKET SI STATUS message. If not present, '0' shall be assumed by the receiver</p>
<p><b>PS_REL_REQ</b> (1 bit field)</p> <p>This field indicates whether the mobile station requests the release of the RR connection and packet resources. This field may only be set to "1" in certain cases, see 3GPP TS 44.018. This field shall always be present in the message when the enhanced DTM CS release procedure is ongoing.</p> <p>0 The mobile station does not request the release of the RR connection and packet resources.</p> <p>1 The mobile station requests the release of the RR connection and packet resources.</p>

## 11.2.17c Packet Serving Cell SI

This optional message is sent by the network on the PACCH to provide a SYSTEM INFORMATION message broadcast on the BCCH. For example, several instances of this message may be sent by the network in a cell supporting PACKET SI STATUS following the request for acquisition of system information by a mobile station. This message shall not be segmented across more than one RLC/MAC control block.

Message type: PACKET SERVING CELL SI

Direction: network to mobile station

Classification: distribution message

**Table 11.2.17c.1: Packet Serving Cell SI information elements**

<pre>&lt; Packet Serving Cell SI message content &gt; ::=   &lt; PAGE_MODE : bit (2) &gt;   &lt; CONTAINER_DATA : octet ** &gt;   &lt; padding bits &gt;z   ! &lt; Distribution part error : bit (*) = &lt; no string &gt; &gt; ;</pre>
---

**Table 11.2.17c.2: Packet Serving Cell SI information element details**

<p>The Packet Serving Cell SI message contains a serving cell SYSTEM INFORMATION message from the BCCH.</p>
<p><b>PAGE_MODE</b> (2 bit field)</p> <p>This field is defined in sub-clause 12.20.</p>
<p><b>CONTAINER_DATA</b>(n*8 bits)</p> <p>The CONTAINER_DATA octets forms the actual SI message content. The information contained in the Packet Serving Cell SI message shall exclude the following information elements from the beginning of the SI message: L2 Pseudo Length; RR management Protocol Discriminator and Skip Indicator.</p> <p>Extra octets of padding bits at the end of the SI message may be excluded.</p>

## 11.2.18 Packet System Information Type 1

This message is sent by the network on the PBCCH or PACCH giving information for Cell selection, for control of the PRACH, for description of the control channel(s) and global power control parameters. This message shall not be segmented across more than one RLC/MAC control block by using the procedures specified in sub-clause 9.1.12a. Special requirements for the transmission of this message apply on the PBCCH, see 3GPP TS 45.002.

Message type: PACKET SYSTEM INFORMATION TYPE 1

Direction: network to mobile station

Classification: distribution message

**Table 11.2.18.1: PSI1 information elements**

<pre> &lt; PSI1 message content &gt; ::=   &lt; PAGE_MODE : bit (2) &gt;   &lt; PBCCH_CHANGE_MARK : bit (3) &gt;   &lt; PSI_CHANGE_FIELD : bit (4) &gt;   &lt; PSI1_REPEAT_PERIOD : bit (4) &gt;   &lt; PSI_COUNT_LR : bit (6) &gt;   { 0   1 &lt; PSI_COUNT_HR : bit (4) &gt; }   &lt; MEASUREMENT_ORDER : bit (1) &gt;   &lt; GPRS Cell Options : &lt; GPRS Cell Options IE &gt; &gt;   &lt; PRACH Control Parameters : &lt; PRACH Control Parameters IE &gt; &gt;   &lt; PCCCH Organization Parameters : &lt; PCCCH Organization Parameters IE &gt; &gt;   &lt; Global Power Control Parameters : &lt; Global Power Control Parameters IE &gt; &gt;   &lt; PSI_STATUS_IND : bit &gt;   { null   0 -- Receiver backward compatible with earlier release       1 -- Additions in release 99 :     &lt; MSCR : bit &gt;     &lt; SGSNR : bit &gt;     &lt; BAND_INDICATOR : bit &gt;     { null   0 -- Receiver backward compatible with earlier release         1 -- Additions in Rel-6 :       { 0   1 &lt; LB_MS_TXPWR_MAX_CCH : bit (5) &gt; }       &lt; padding bits &gt; } }   ! &lt; Distribution part error : bit (*) = &lt; no string &gt; &gt; ; </pre>
--

**Table 11.2.18.2: PSI1 information element details**

<p><b>GPRS Cell Options</b> This information element is defined in sub-clause 12.24</p>
<p><b>Global Power Control Parameters</b> This information element is defined in sub-clause 12.9.</p>
<p><b>MEASUREMENT ORDER</b> (1 bit field) The MEASUREMENT ORDER field indicates if set = 0 that the mobile station is in control of the cell re-selection in both packet idle mode and packet transfer mode and that the mobile station shall not send any measurement reports to the network (= NC0 in 3GPP TS 45.008). It also indicates that the Optional PSI5 message is not broadcast. If set = 1 the mobile station shall send measurement reports for cell re-selection to the network. Further cell re-selection and measurement details are included in the PSI5 message.</p>
<p><b>PAGE_MODE</b> (2 bit field) This field describes which type of page mode used, i.e. either normal paging, extended paging, paging reorganization or same as before from the previous page mode. The mobile station shall ignore this field if the message is received on the PACCH. Coding of this field is defined in 3GPP TS 44.018.</p>
<p><b>PBCCH_CHANGE_MARK</b> (3 bit field) The PBCCH_CHANGE_MARK field is a 3 bit counter incremented with one each time information has been changed in one or more of the broadcast PSI2-PSIn messages on PBCCH (n&gt;2).</p>

<p><b>PSI_CHANGE_FIELD</b> (4 bit field)</p> <p>The PSI_CHANGE_FIELD is a 4 bit value reflecting which PSI message or group of instantiated PSI message was most recent updated when the PBCCH_CHANGE_MARK was last incremented. If more than one PSI message or group of instantiated PSI message were changed at the same time, the PSI_CHANGE_FIELD indicates unspecified updates. Range 0 to 15.</p> <p>Bit</p> <p>4 3 2 1</p> <p>0 0 0 0 Update of unspecified PSI message(s);</p> <p>0 0 0 1 Unknown</p> <p>0 0 1 0 PSI2 updated</p> <p>0 0 1 1 PSI3/PSI3bis/PSI3ter/PSI3quater updated</p> <p>0 1 0 0 Unknown -- <i>This value was allocated in an earlier version of the protocol and shall not be used</i></p> <p>0 1 0 1 PSI5 updated</p> <p>0 1 1 0 PSI6 updated</p> <p>0 1 1 1 PSI7 updated</p> <p>1 0 0 0 PSI8 updated</p> <p>All other values shall be interpreted as 'Update of unknown SI message type'.</p>
<p><b>PSI1_REPEAT_PERIOD</b> (4 bit field)</p> <p>This field is the binary representation of the PSI1_REPEAT_PERIOD parameter value minus one, see 3GPP TS 45.002. The field is coded according to the following table:</p> <p>Bit</p> <p>4 3 2 1</p> <p>0 0 0 0 PSI1_REPEAT_PERIOD = 1</p> <p>0 0 0 1 PSI1_REPEAT_PERIOD = 2</p> <p>...</p> <p>1 1 1 1 PSI1_REPEAT_PERIOD = 16</p>
<p><b>PSI_COUNT_LR</b> (6 bit field)</p> <p>This field is the binary representation of the PSI_COUNT_LR parameter, see 3GPP TS 45.002. The field is coded according to the following table:</p> <p>Bit</p> <p>6 5 4 3 2 1</p> <p>0 0 0 0 0 0 PSI_COUNT_LR = 0</p> <p>0 0 0 0 0 1 PSI_COUNT_LR = 1</p> <p>...</p> <p>1 1 1 1 1 1 PSI_COUNT_LR = 63</p>
<p><b>PSI_COUNT_HR</b> (4 bit field)</p> <p>This field is the binary representation of the PSI_COUNT_HR parameter value minus one, see 3GPP TS 45.002. If PSI_COUNT_HR is not included in PSI1 message, the default value PSI_COUNT_HR = 0 applies. The field is coded according to the following table:</p> <p>Bit</p> <p>4 3 2 1</p> <p>0 0 0 0 PSI_COUNT_HR = 1</p> <p>0 0 0 1 PSI_COUNT_HR = 2</p> <p>...</p> <p>1 1 1 1 PSI_COUNT_HR = 16</p>
<p><b>PCCCH Organization Parameters</b></p> <p>This information element is defined in sub-clause 12.25</p>
<p><b>PRACH Control Parameters</b></p> <p>This information element is defined in sub-clause 12.14.</p>
<p><b>PSI_STATUS_IND</b> (1 bit field):</p> <p>0 The network does not support the PACKET PSI STATUS message;</p> <p>1 The network supports the PACKET PSI STATUS message.</p>

<p><b>MSCR</b>, MSC Release (1 bit field):</p> <p>0 The MSC is Release '98 or older</p> <p>1 The MSC is Release '99 onwards</p>
<p><b>SGSNR</b>, SGSN Release (1 bit field)</p> <p>0 The SGSN is Release '98 or older</p> <p>1 The SGSN is Release '99 onwards</p>
<p><b>BAND_INDICATOR</b> (1 bit field)</p> <p>See 3GPP TS 45.005 for definition of this field, which is coded as follows:</p> <p>0 ARFCN indicates 1800 band</p> <p>1 ARFCN indicates 1900 band</p>
<p><b>LB_MS_TXPWR_MAX_CCH</b> (5 bit field)</p> <p>The LB_MS_TXPWR_MAX_CCH field is coded as the binary representation of the 'power control level' in 3GPP TS 45.005 corresponding to the maximum TX power level a mobile station may use when accessing on a packet control channel. This value shall be used by the mobile station according to 3GPP TS 45.008.</p>

NOTE 1: The MSC Release bit indicates the version of the MSC specific protocols and is not applicable to access stratum protocols.

NOTE 2: The SGSN Release bit indicates the version of the SGSN specific protocols and is not applicable to access stratum protocols.

## 11.2.19 Packet System Information Type 2

This message is sent by the network on PBCCH and PACCH giving information of reference frequency lists, cell allocation, GPRS mobile allocations and PCCCH descriptions being used in the cell. Special requirements for the transmission of this message apply on PBCCH, see 3GPP TS 45.002.

PSI2 also contains Non-GPRS cell options applicable for non-packet access.

This message shall not be segmented across more than one RLC/MAC control block by using the procedures specified in sub-clause 9.1.12a. A consistent set of this message type is required to completely decode the information (see sub-clause 5.5.2.1.4).

Message type: PACKET SYSTEM INFORMATION TYPE 2

Direction: network to mobile station

Classification: distribution message

Table 11.2.19.1: PSI2 information elements

```

< PSI2 message content > ::=
  < PAGE_MODE : bit (2) >
  < PSI2_CHANGE_MARK : bit (2) >
  < PSI2_INDEX : bit (3) >
  < PSI2_COUNT : bit (3) >
  {
    { 0 | 1 < Cell Identification : < Cell Identification IE > > }
    { 0 | 1 < Non GPRS Cell Options : < Non GPRS Cell Options IE > > }
    < Reference Frequency Lists : < Reference Frequency Lists struct > >
    < Cell Allocation : < Cell Allocation Lists struct > >
    < GPRS Mobile Allocations : < GPRS Mobile Allocations Lists struct > >
    < PCCCH Description : < PCCCH Description Lists struct > >
    {
      null | 0 bit** = < no string >
      | 1
      -- Release 1999 additions:
      { 0 | 1 < COMPACT Control Information : < COMPACT Control Info struct > > }
      { 0 | 1 < Additional PSI Messages : < Additional PSI Messages struct > > }
      < padding bits > } // -- truncation at end of message allowed, bits '0' assumed
    ! < Distribution part error : bit (*) = < no string > > ;

< Reference Frequency Lists struct > ::= { 1 < Reference Frequency struct > } ** 0;
< Reference Frequency struct > ::=
  < RFL_NUMBER : bit (4) >
  < Length of RFL contents : bit (4) >
  < RFL contents : octet (val(Length of RFL contents) + 3) > ;

< Cell Allocation Lists struct > ::= { 1 < Cell Allocation struct > } ** 0 ;
< Cell Allocation struct > ::=
  < RFL_NUMBER : bit (4) > ;

< GPRS Mobile Allocations Lists struct > ::= { 1 < GPRS Mobile Allocations struct > } ** 0 ;
< GPRS Mobile Allocations struct > ::=
  < MA_NUMBER : bit (4) >
  < GPRS Mobile Allocation : < GPRS Mobile Allocation IE > > ;

< PCCCH Description Lists struct > ::= { 1 < PCCCH Description struct > } ** 0 ;
< PCCCH Description struct > ::=
  < TSC : bit (3) >
  { 0 < Non-hopping PCCCH carriers : < Non-Hopping PCCCH Carriers Lists struct > >
  | 1 < MA_NUMBER : bit (4) >
  < Hopping PCCCH carriers : < Hopping PCCCH Carriers Lists struct > > } ;

< Non-hopping PCCCH Carriers Lists struct > ::= { 1 < Non-Hopping PCCCH Carriers struct > } ** 0 ;
< Non-Hopping PCCCH Carriers struct > ::=
  < ARFCN : bit (10) >
  < TIMESLOT_ALLOCATION : bit (8) > ;

< Hopping PCCCH Carriers Lists struct > ::= { 1 < Hopping PCCCH Carriers struct > } ** 0 ;
< Hopping PCCCH Carriers struct > ::=
  < MAIO : bit (6) >
  < TIMESLOT_ALLOCATION : bit (8) > ;

< COMPACT Control Info struct > ::=
  < Large Cell Operation : bit (1) >
  { 0 | 1 < Number of Idle Blocks : < Number of Idle Blocks struct > > }
  { 0 | 1 < N_CCCH_NH : bit (4) > } ;

<Number of Idle Blocks struct > ::=
  { 0 | 1 { < NIB_CCCH_0 : bit (4) > } }
  { 0 | 1 { < NIB_CCCH_1 : bit (4) > } }
  { 0 | 1 { < NIB_CCCH_2 : bit (4) > } }
  { 0 | 1 { < NIB_CCCH_3 : bit (4) > } } ;

```



```

< Additional PSI Messages struct > ::=
  < NON_GSM_INFORMATION : bit(2) >
  < PSI8_BROADCAST : bit (1) >
  < PSI3ter_BROADCAST : bit (1) >
  < PSI3quater_BROADCAST : bit (1) > ;

```

Table 11.2.19.2: PSI2 information element details

<p><b>PAGE_MODE</b> (2 bit field)</p> <p>This field describes which type of page mode used, i.e. either normal paging, extended paging, paging reorganization or same as before from the previous page mode. The mobile station shall ignore this field if the message is received on the PACCH. Coding of this field is defined in 3GPP TS 44.018</p>
<p><b>PSI2_CHANGE_MARK</b> (2 bit field)</p> <p>This field is the binary representation of the PSI <i>change mark</i> parameter identifying a consistent set of PSI2 messages. Range: 0 to 3.</p>
<p><b>PSI2_INDEX</b> (3 bit field) and <b>PSI2_COUNT</b> (3 bit field)</p> <p>These fields are the binary representation of the PSI <i>index</i> and PSI <i>count</i> parameters associated with the PSI2 message.</p>
<p><b>Cell Identification</b></p> <p>This information element is defined in sub-clause 12.23. This field shall be present in at least one instance of PSI2 and may appear only once in a complete set of PSI2 messages.</p>
<p><b>Non GPRS Cell Options</b></p> <p>This field is defined in sub-clause 12.27. This field shall be present in at least one instance of PSI2.</p>
<p><b>Reference Frequency Lists</b> (construction)</p> <p>This construction is the representation of the reference frequency lists provided in an instance of the PSI2 message. An RFL_NUMBER field preceding each reference frequency list (RFL) identifies the RFL.</p>
<p><b>Cell Allocations</b> (construction)</p> <p>This construction is a representation of the cell allocation (CA) defined for the cell. The set of radio frequency channels contained in the referenced RFLs in this construction defines the cell allocation.</p>
<p><b>GPRS Mobile Allocations</b> (construction)</p> <p>This construction is the representation of the GPRS mobile allocations provided in an instance of the PSI2 message. An MA_NUMBER field preceding each GPRS mobile allocation identifies the GPRS mobile allocation. The receiver shall disregard a GPRS mobile allocation provided in this message that is identified by MA_NUMBER = 14 or 15.</p>
<p><b>PCCCH Description</b> (construction)</p> <p>This construction is a representation of the timeslots carrying PCCCH in the cell and their frequency configurations. The training sequence code (TSC) preceding each list of PCCCH carriers in the PCCCH description shall be used for the timeslots selected for PCCCH on those PCCCH carriers. The TSC that is used for the timeslot also carrying PBCCH shall equal the TSC used for the PBCCH in the cell.</p> <p>The number of timeslots carrying PCCCH in the cell is denoted KC. This is also the implicit value of the parameter BS_PCC_CHANS, see 3GPP TS 45.002. The range for KC is 1 to 16 if PBCCH (and PCCCH) is present in the cell. (KC = 0 if PBCCH is not present in the cell.)</p> <p>The mapping of the PCCCH_GROUPS (numbered from 0 to KC-1) starts with the lowest numbered PCCCH_GROUP, which is mapped on the lowest numbered timeslot carrying PCCCH on the first (non-hopping or hopping) PCCCH carrier appearing in this construction. The next higher numbered PCCCH_GROUP is mapped on the next (if any) higher numbered timeslot carrying PCCCH on the same carrier, and so on. When all timeslots carrying PCCCH on the first carrier have been used, the next higher numbered PCCCH_GROUP is mapped on the lowest numbered timeslot carrying PCCCH on the next PCCCH carrier appearing in this construction, and so on. The highest numbered PCCCH_GROUP is mapped on the highest numbered timeslot carrying PCCCH on the last PCCCH carrier appearing in this construction.</p>

<p><b>RFL_NUMBER</b> (4 bit field) This field is the binary identification of an RFL provided in this message or the binary reference to such. Range: 0 to 15.</p>
<p><b>RFL contents</b> (variable length octet string) This variable length octet string is the representation of a set of radio frequency channels defining an RFL provided in the PSI2 message. The encoding of the octet string is defined by the <i>value part</i> of the type 4 information element <i>Frequency List</i>, defined in 3GPP TS 44.018. The allowed formats of the <i>Frequency List</i> information element are the <i>bit map 0</i>, <i>1024 range</i>, <i>512 range</i>, <i>256 range</i>, <i>128 range</i> and <i>variable bit map</i> formats.</p>
<p><b>MA_NUMBER</b> (4 bit field) This field is the binary identification of a GPRS Mobile Allocation provided in this message or the binary reference to such. Range: 0 to 13. (MA_NUMBER = 14 and 15 shall not be used in this message.)</p>
<p><b>GPRS Mobile Allocation</b> (information element) The <i>GPRS Mobile Allocation</i> information element is defined in sub-clause 12.10a.</p>
<p><b>TSC</b> (3 bit field) This field is the binary representation of the training sequence code, see 3GPP TS 45.002. Range: 0 to 7.</p>
<p><b>ARFCN</b> (10 bit field) This field is the binary representation of the absolute radio frequency channel number (ARFCN) defined in 3GPP 45.005. Range 0 to 1023.</p>
<p><b>MAIO</b> (6 bit field) This field is the binary representation of the mobile allocation index offset (MAIO), see 3GPP TS 45.002. Range: 0 to 63.</p>
<p><b>TIMESLOT_ALLOCATION</b> (8 bit field) This field indicates which timeslot are assigned as PCCCH. This field is coded as defined in sub-clause 12.18. . Note that for a CPCCCH this information shall be ignored by the MS, the CPCCCH is rotating between odd timeslots and not allocated to a specific timeslot, see 3GPP TS 45.002.</p>
<p><b>Large Cell Operation</b> (LARGE_CELL_OP) If this bit is set to one, the cell is in large cell operation mode (see 3GPP TS 45.002).</p> <p>0 This cell is a nominal size cell 1 This cell is a large cell</p>
<p><b>NIB_CCCH_0</b> (4 bit field) This field is the binary representation of the number of radio blocks that shall remain idle in time group 0 for blocks associated with CPBCCH and CPCCCH (see 3GPP TS 45.002). If this information element is not present the value 0 shall be used. Note that this information element shall not be present for the serving cell time group (e.g. if the serving cell time group is time group zero, this information element is not present, but if the serving cell time group is time group one this information element is present).</p>
<p><b>NIB_CCCH_1, NIB_CCCH_2, NIB_CCCH_3</b> Defined exactly as NIB_CCCH_0, except applied to time group 1, 2, and 3 respectively.</p>
<p><b>N_CCCH_NH</b> (4 bit field) This field is the binary representation of the amount of non-hopping blocks on control channels (see 3GPP TS 45.002). Range 1 to 11.</p>
<p><b>Additional PSI messages struct</b> If any of the PSI messages named in this structure are broadcast in the cell, this field shall be present in at least one instance of PSI2 and may appear only once in a complete set of PSI2 messages.</p>

<p><b>NON_GSM_INFORMATION</b> (2 bit field)</p> <p>This field indicates whether non-GSM information is broadcast on the cell and specifies the messages that are used for this purpose. If this field indicates that both PSI6 and PSI7 are broadcast on the cell, these messages shall be broadcast within different repetition rate groups (see 3GPP TS 45.002).</p> <p>Bit 2 1</p> <p>0 0 non-GSM information is not broadcast on the cell 0 1 non-GSM information is broadcast on the cell in PSI6 message 1 0 non-GSM information is broadcast on the cell in PSI7 message 1 1 non-GSM information is broadcast on the cell in PSI6 and PSI7 messages</p>
<p><b>PSI8_BROADCAST</b> (1 bit field)</p> <p>0 PSI8 is not broadcast on the cell 1 PSI8 is broadcast on the cell</p>
<p><b>PSI3ter_BROADCAST</b> (1 bit field)</p> <p>0 PSI3ter is not broadcast on the cell 1 PSI3ter is broadcast on the cell</p>
<p><b>PSI3quater_BROADCAST</b> (1 bit field)</p> <p>0 PSI3quater is not broadcast on the cell 1 PSI3quaer is broadcast on the cell</p>

### 11.2.19.1 Reference Frequency Lists in PSI2

A Reference Frequency Lists construction may be included in each instance of the PSI2 message. The presence of reference frequency lists (RFLs) is optional. RFLs shall be provided as required for the decoding of GPRS mobile allocations and cell allocation.

### 11.2.19.2 Cell Allocation in PSI2

A Cell Allocation construction shall not be included in more than one instance of the PSI2 message within the consistent set of PSI2 messages. The presence of a Cell Allocation construction is optional. It shall be provided as required for the decoding of GPRS mobile allocations and for the support of GPRS mobile stations which may access the network in dedicated, group receive and group transmit modes, see 3GPP TS 44.018.

### 11.2.19.3 GPRS Mobile Allocation in PSI2

A GPRS Mobile Allocations construction may be included in each instance of the PSI2 message. The presence of GPRS mobile allocations is optional. The GPRS mobile allocations shall be provided as required for determining the frequency configuration of PDCHs.

### 11.2.19.4 PCCCH Description

A PCCCH Description construction shall be included in one and only one instance of the PSI2 message within the consistent set of PSI2 messages.

### 11.2.19.5 Abnormal cases

If the receiver detects any violation against the rules for the appearance of the different constructions defined for this message within the consistent set of this message type, it may regard the contents of these messages as invalid.

## 11.2.20 Packet System Information Type 3

This message is sent by the network on the PBCCH or PACCH giving information of the BCCH allocation (BA(GPRS)) in the neighbour cells and cell selection parameters for serving cell and non-serving cells. This message shall not be segmented across more than one RLC/MAC control block by using the procedures specified in sub-clause 9.1.12a. Special requirements for the transmission of this message apply on the PBCCH, see 3GPP TS 45.002.

Message type: PACKET SYSTEM INFORMATION TYPE 3

Direction: network to mobile station

Classification: distribution message

Table 11.2.20.1: PSI3 information elements

```

< PSI3 message content > ::=
  < PAGE_MODE : bit (2) >
  < PSI3_CHANGE_MARK : bit (2) >
  < PSI3_BIS_COUNT : bit (4) >
  < Serving Cell parameters : < Serving Cell params struct > >
  < General Cell Selection parameter : < Gen Cell Sel struct > >
  < Neighbour Cell parameters : { 1 < Neighbour Cell params struct > } ** 0 >
  {
    null | 0 bit** = < no string >
    | 1
      -- Release 1998 additions:
      < Serving Cell LSA ID information : < LSA ID information struct > >
      { 0 | 1 < LSA Parameters : < LSA Parameters IE >> }
      {
        null | 0 bit** = < no string >
        | 1
          -- Release 1999 additions:
          0 0 -- The values '01', '10' and '11' were allocated in an earlier version of the protocol
              -- and shall not be used.
          { 0 | 1 < COMPACT Information : < COMPACT Information struct > > }
          0 -- The value '1' was used in an earlier version of the protocol and shall not be used.
          {
            null | 0 bit** = < no string >
            | 1
              -- Rel-4 additions:
              { 0 | 1 < CCN Support Description : < CCN Support Description struct >> }
              {
                null | 0 bit** = < no string >
                | 1
                  -- Rel-5 additions:
                  < CELL_BAR_QUALIFY 3 : bit (2) > -- Serving cell barring status.
                  < lu Mode Neighbour Cell Parameters : { 1 < lu Mode Neighbour Cell params struct > } ** 0 >
                  --Supplementary information for dual lu mode and A/Gb mode capable cells
                  < lu mode Only Neighbour Cell Parameters :
                    { 1 < lu mode Only Neighbour Cell params struct > } ** 0 >
                    < padding bits > } } }
          ! < Distribution part error : bit (*) = < no string > > ;
  }

< Serving Cell params struct > ::=
  < CELL_BAR_ACCESS_2 : bit >
  < EXC_ACC : bit >
  < GPRS_RXLEV_ACCESS_MIN : bit (6) >
  < GPRS_MS_TXPWR_MAX_CCH : bit (5) >
  { 0 | 1 < HCS Serving Cell parameters : < HCS struct > > }
  < MULTIBAND_REPORTING : bit (2) >;

< HCS struct > ::=
  < PRIORITY_CLASS : bit (3) >
  < HCS_THR : bit (5) >;

< Gen Cell Sel struct > ::=
  < GPRS_CELL_RESELECT_HYSTERESIS : bit (3) >
  < C31_HYST : bit (1) >
  < C32_QUAL : bit (1) >
  1 -- The value '0' was used in an earlier version of the protocol and shall not be used.
  { 0 | 1 < T_RESEL : bit (3) > }
  { 0 | 1 < RA_RESELECT_HYSTERESIS : bit (3) > } ;

< Neighbour Cell params struct > ::=
  < START_FREQUENCY : bit (10) >
  < Cell selection params : < Cell Selection struct > >
  < NR_OF_REMAINING_CELLS : bit (4) >
  < FREQ_DIFF_LENGTH : bit (3) >
  {
    < FREQUENCY_DIFF : bit (1 + val(FREQ_DIFF_LENGTH)) >
    < Cell Selection Params : < Cell Selection struct >> } * (val(NR_OF_REMAINING_CELLS));

```

```

< Cell Selection struct > ::=
  < BSIC : bit (6) >
  < CELL_BAR_ACCESS_2 : bit >
  < EXC_ACC : bit >
  < SAME_RA_AS_SERVING_CELL : bit (1) >
  { 0 | 1 < GPRS_RXLEV_ACCESS_MIN : bit (6) >
    < GPRS_MS_TXPWR_MAX_CCH : bit (5) > }
  { 0 | 1 < GPRS_TEMPORARY_OFFSET : bit (3) >
    < GPRS_PENALTY_TIME : bit (5) > }
  { 0 | 1 < GPRS_RESELECT_OFFSET : bit (5) > }
  { 0 | 1 < HCS params : < HCS struct > > }
  { 0 | 1 < SI13 PBCCH Location : < SI13 PBCCH Location struct > > };

< SI13 PBCCH Location struct > ::=
  { 0 < SI13_LOCATION : bit (1) >
    | 1 < PBCCH_LOCATION : bit (2) >
      < PSI1_REPEAT_PERIOD : bit (4) > };

< LSA ID information struct > ::=
  { 1 { 0 < LSA_ID : bit (24) >
      | 1 < ShortLSA_ID : bit (10) > } } ** 0 ;

< COMPACT Information struct > ::=
  < Cell Identification : Cell identification IE>
  { 1 < COMPACT Neighbour Cell params struct > } ** 0 ;

< COMPACT Neighbour Cell params struct > ::=
  < START_FREQUENCY : bit (10) >
  < COMPACT Cell selection params : < COMPACT Cell Selection struct > >
  < NR_OF_REMAINING_CELLS : bit (4) >
  < FREQ_DIFF_LENGTH : bit (3) >
  { < FREQUENCY_DIFF : bit (1 + val(FREQ_DIFF_LENGTH)) >
    < COMPACT Cell selection params :
      < COMPACT Cell Selection struct > > } * (val(NR_OF_REMAINING_CELLS));

< COMPACT Cell Selection struct > ::=
  < BSIC : bit (6) >
  < CELL_BAR_ACCESS_2 : bit >
  < EXC_ACC : bit >
  < SAME_RA_AS_SERVING_CELL : bit (1) >
  { 0 | 1 < GPRS_RXLEV_ACCESS_MIN : bit (6) >
    < GPRS_MS_TXPWR_MAX_CCH : bit (5) > }
  { 0 | 1 < GPRS_TEMPORARY_OFFSET : bit (3) >
    < GPRS_PENALTY_TIME : bit (5) > }
  { 0 | 1 < GPRS_RESELECT_OFFSET : bit (5) > }
  { 0 | 1 < HCS params : < HCS struct > > }
  { 0 | 1 < TIME_GROUP : bit (2) > }
  { 0 | 1 < GUAR_CONSTANT_PWR_BLKs : bit (2) > };

< CCN Support Description struct > ::=
  < Number_Cells : bit (7) >
  { CCN_SUPPORTED : bit } * (val(Number_Cells));
  < lu Mode Neighbour Cell Params struct > ::=
    < NR_OF_REMAINING_CELLS : bit (4) >
    { 0 | 1 < lu Mode Cell Selection Params :
      < lu Mode Cell Selection struct > > } * (val(NR_OF_REMAINING_CELLS));
  < lu Mode Cell Selection struct > ::=
    < CELL BAR QUALIFY 3 : bit (2) >
    { 0 | 1 < SI13Alt PBCCH Location: < SI13 PBCCH Location struct > > };
  < lu mode Only Neighbour Cell params struct > ::=
    < START_FREQUENCY : bit (10) >
    < lu mode Only Cell selection params : < lu mode Only Cell Selection struct > >
    < NR_OF_REMAINING_CELLS : bit (4) >
    < FREQ_DIFF_LENGTH : bit (3) >
    { < FREQUENCY_DIFF : bit (1 + val(FREQ_DIFF_LENGTH)) >
      < lu mode Only Cell selection params :
        < lu mode Only Cell Selection struct > > } * (val(NR_OF_REMAINING_CELLS));

```

```

< lu Mode Only Cell Selection struct > ::=
  < BSIC : bit (6) >
  < CELL_BAR_QUALIFY_3 : bit (2) >
  < SAME_RA_AS_SERVING_CELL : bit (1) >
  { 0 | 1 < GPRS_RXLEV_ACCESS_MIN : bit (6) >
    < GPRS_MS_TXPWR_MAX_CCH : bit (5) > }
  { 0 | 1 < GPRS_TEMPORARY_OFFSET : bit (3) >
    < GPRS_PENALTY_TIME : bit (5) > }
  { 0 | 1 < GPRS_RESELECT_OFFSET : bit (5) > }
  { 0 | 1 < HCS params : < HCS struct > > }
  { 0 | 1 < SI13Alt PBCCH Location : < SI13 PBCCH Location struct > > };

```

Table 11.2.20.2: PSI3 information element details

<p><b>PAGE_MODE</b> (2 bit field)</p> <p>This field describes which type of page mode used, i.e. either normal paging, extended paging, paging reorganization or same as before from the previous page mode. The mobile station shall ignore this field if the message is received on the PACCH. Coding of this field is defined in 3GPP TS 44.018</p>
<p><b>PSI3_CHANGE_MARK</b> (2 bit field)</p> <p>The PSI3 change mark field is changed each time information has been updated in any of the PSI3, PSI3 bis, PSI3 ter or PSI3 quater messages. A new value indicates that the mobile station shall re-read the information from the PSI3 and all PSI3 bis, PSI3 ter and PSI3 quater messages. The coding of this field is network dependent.</p> <p>Range: 0-3.</p>
<p><b>PSI3_BIS_COUNT</b> (4 bit field)</p> <p>This field is coded as the binary representation of the PSI3 bis index (in the PSI3 bis message) for the last (highest indexed) individual PSI3 bis message.</p> <p>Range: 0-15.</p>
<p><i>Serving Cell Parameters:</i></p> <p><b>CELL_BAR_ACCESS_2</b> (1 bit field)</p> <p>This field combines the CELL_BAR_ACCESS and CELL_BAR_QUALIFY parameters and indicates the status for cell reselection, see 3GPP TS 45.008:</p> <p>0 Status for cell reselection is set to <i>normal</i>;  1 Status for cell reselection is set to <i>barred</i>.</p>
<p><b>EXC_ACC</b> (1 bit field)</p> <p>EXC_ACC is used by the network to prevent mobiles without exclusive access rights from camping on the cell. The usage of EXC_ACC is described in 3GPP TS 43.022. The coding of EXC_ACC is as follows:</p> <p>0 The cell is not used for SoLSA exclusive access.  1 The cell is used for SoLSA exclusive access.</p>
<p><b>GPRS_RXLEV_ACCESS_MIN</b> (6 bit field)</p> <p>The GPRS_RXLEV_ACCESS_MIN field is coded as the binary representation of the 'RXLEV_ACCESS_MIN' defined in 3GPP TS 45.008. It is the minimum received level at the mobile station required for access to the system.</p>
<p><b>GPRS_MS_TXPWR_MAX_CCH</b> (5 bit field)</p> <p>The GPRS_MS_TXPWR_MAX_CCH field is coded as the binary representation of the 'power control level' in 3GPP TS 45.005 corresponding to the maximum TX power level a mobile station may use when accessing on a packet control channel. This value shall be used by the mobile station according to 3GPP TS 45.008.</p>
<p><i>HCS struct</i></p> <p>If the HCS struct is omitted for the serving cell, HCS is not used and the HCS parameters for the other cells shall be neglected i.e the HCS signal strength threshold shall be set to infinity for all cells. Otherwise PRIORITY_CLASS and HCS_THR are defined. The use of the HCS parameters is defined in 3GPP TS 45.008.</p>

<p><b>PRIORITY_CLASS</b> (3 bit field) The PRIORITY_CLASS field contains the binary representation of the HCS priority for the cell.</p> <p>Bit 3 2 1 0 0 0      Lowest Priority ..... 1 1 1      Highest Priority</p>
<p><b>HCS_THR</b> (5 bit field) The HCS_THR is the HCS signal strength threshold</p> <p>Bit 5 4 3 2 1 0 0 0 0 0      -110 dBm 0 0 0 0 1      -108 dBm ...              ... 1 1 1 1 0      -50 dBm 1 1 1 1 1      infinity</p>
<p><b>MULTIBAND_REPORTING</b> (2 bit field) Binary encoding of multiband reporting parameter as specified in 3GPP TS 45.008 Range 0-3.</p>
<p><i>General Cell Selection Parameters</i></p> <p><b>GPRS_CELL_RESELECT_HYSTERESIS</b> (3 bit field) The GPRS_CELL_RESELECT_HYSTERESIS field indicates the Additional Hysteresis which applies in Ready state in <i>A/Gb mode</i> and RRC-Cell_Shared state in <i>Iu mode</i> for cells in same RA. This field is encoded according to the following table:</p> <p>Bit 3 2 1 0 0 0      0 dB 0 0 1      2 dB 0 1 0      4 dB 0 1 1      6 dB 1 0 0      8 dB 1 0 1      10 dB 1 1 0      12 dB 1 1 1      14 dB</p>
<p><b>C31_HYST</b> (1 bit field) The C31_HYST field indicates if set to 1 that the GPRS_CELL_RESELECT_HYSTERESIS shall be applied to the C31 criterion.</p> <p><b>C32_QUAL</b> (1 bit field) C32_QUAL is a flag indicating an exception rule for GPRS_RESELECT_OFFSET according to 3GPP TS 45.008.</p>



**T\_RESEL** (3 bit field)

If the mobile station has performed an abnormal release with cell reselection (see sub-clause 9.4.2) from this cell, the mobile station is not allowed to reselect this cell for T\_RESEL seconds if another cell is available. The default value of T\_RESEL is 5 s. If the field is omitted from the message, the default value shall be used by the mobile station.

Bit

3 2 1

0 0 0	5 s
0 0 1	10 s
0 1 0	15 s
0 1 1	20 s
1 0 0	30 s
1 0 1	60 s
1 1 0	120 s
1 1 1	300 s

**RA\_RESELECT\_HYSTERESIS** (3 bit field)

The RA\_RESELECT\_HYSTERESIS field indicates in both STANDBY and READY state in *A/Gb mode* and RRC-Idle and RRC-Connected mode in *Iu mode* the additional hysteresis which applies when selecting a cell in a new Routing Area. If this field is not present, the default value is GPRS\_CELL\_RESELECT\_HYSTERESIS. This field is encoded according to the following table:

Bit

3 2 1

0 0 0	0 dB
0 0 1	2 dB
0 1 0	4 dB
0 1 1	6 dB
1 0 0	8 dB
1 0 1	10 dB
1 1 0	12 dB
1 1 1	14 dB

*Neighbour Cell Parameters*

The Neighbour cell parameters are used to specify neighbour cells (BA(GPRS)) and their corresponding cell selection parameters. The Neighbour cell parameters are specified in PSI3 and in at least one instance of PSI3bis. If one instance of PSI3bis is not sufficient to specify the cell selection parameters of all neighbour cells, the remaining neighbour cells are specified in consecutive instances of PSI3bis. If all information fits within the PSI3 message, one instance of PSI3bis without any neighbour cell parameters is broadcast.

NOTE: For efficient coding, cells with common cell selection parameters may be grouped together.

Building of BA(GPRS) is defined in sub-clause 5.6.3.2.

**START\_FREQUENCY** (10 bit field)

The START\_FREQUENCY defines the ARFCN for the first carrier in the list (ARFCN(0)). **FREQ\_DIFF\_LENGTH** (3 bit field)

This field is required to calculate the number of bits to be used for the FREQUENCY\_DIFF field in the current frequency group.

**FREQUENCY\_DIFF** (1+val(FREQ\_DIFF\_LENGTH) bit field)

Each FREQUENCY\_DIFF parameter field specifies the difference in frequency to the next carrier to be defined. The FREQUENCY\_DIFF parameter encodes a non negative integer in binary format (W).

Each frequency following the start frequency (ARFCN(0)) and belonging to the Frequency List struct is then calculated by the formula  $ARFCN(n) = (ARFCN(n-1) + W(n)) \text{ modulus } 1024$ ,  $n=1, \dots, \text{val}(NR\_OF\_REMAINING\_CELLS)$ .

**General rules for handling neighbour cell parameter default values**

The first neighbour cell defined in PSI3 uses as its default parameter values the parameter values defined for the serving cell. If a parameter is omitted for the serving cell then the specified default value shall be used. The following neighbour cells use the parameter values of the previous neighbour cell as their default values.

**Cell Selection params**

The first field of the Cell Selection struct, *BSIC*, defines the BSIC of the cell and then comes the fields *CELL\_BAR\_ACCESS\_2*, *ECX\_ACC* and *SAME\_RA\_AS\_SERVING\_CELL*. Then follows none, some, or all of the fields *GPRS\_RXLEV\_ACCESS\_MIN*, *GPRS\_MS\_TXPWR\_MAX\_CCH*, *GPRS\_TEMPORARY\_OFFSET*, *GPRS\_PENALTY\_TIME*, *GPRS\_RESELECT\_OFFSET*, HCS params, *SI13\_PBCCH\_LOCATION*, *PCCH\_TYPE* and *PSI1\_REPEAT\_PERIOD*. If fields are omitted, the values for these parameters are the same as for the preceding cell unless otherwise specified for the parameter.

**BSIC** (6 bit field)

The BSIC field is coded as the 'Base Station Identity Code' defined in 3GPP TS 23.003. One BSIC for each carrier in BA(GPRS) is defined.

**CELL\_BAR\_ACCESS\_2** (1 bit field)**EXC\_ACC** (1 bit field)

For definition see Serving Cell parameters

**SAME\_RA\_AS\_SERVING\_CELL** (1 bit field)

The same RA as serving cell field contains one bit, set to  
 0 if the cell is in a Routeing Area different from the serving cell, or  
 1 if the cell is in the same Routeing Area as the serving cell.

**GPRS\_TEMPORARY\_OFFSET** (3 bit field)

The *GPRS\_TEMPORARY\_OFFSET* field indicates the negative offset to C32 that the mobile station shall use for duration of *GPRS\_PENALTY\_TIME*. It is used by the mobile station as part of its calculation of C32 for the cell reselection process. Default value is 0 dB. If the field is omitted for the first neighbour cell, the default value shall be used by the mobile station.

Bit

3 2 1

0 0 0	0 dB
0 0 1	10 dB
0 1 0	20 dB
0 1 1	30 dB
1 0 0	40 dB
1 0 1	50 dB
1 1 0	60 dB
1 1 1	infinity

**GPRS\_PENALTY\_TIME** (5 bit field)

The *GPRS\_PENALTY\_TIME* defines the length of time for which *GPRS\_TEMPORARY\_OFFSET* is active.

Bit

5 4 3 2 1

0 0 0 0 0	10 s
0 0 0 0 1	20 s
...	
1 1 1 1 1	320 s

**GPRS\_RESELECT\_OFFSET** (5 bit field)

GPRS\_RESELECT\_OFFSET is used by the mobile station to apply a positive or negative offset and a hysteresis to the GPRS cell reselection criterion. Default value is 0 dB. If the field is omitted from the message, the default value shall be used by the mobile station.

Bit

5 4 3 2 1	
0 0 0 0 0	-52 dB
0 0 0 0 1	-48 dB
...	
0 1 0 1 0	-12 dB
0 1 0 1 1	-10 dB
...	
1 0 1 1 0	+12 dB
1 0 1 1 1	+16 dB
...	
1 1 1 1 1	+48 dB

**SI13\_PBCCH\_LOCATION construction**

The optional SI13\_PBCCH\_LOCATION struct may either indicate the position of the SI13 message or a PBCCH position. If not included, SI3 and SI4 in the neighbour cell indicates if the neighbour cell supports GPRS.

**SI13\_LOCATION** (1 bit field)

The SI13\_LOCATION field, if present, indicates the logical channel where the SYSTEM INFORMATION TYPE 13 is broadcast (see 3GPP TS 45.002).

- 0 SYSTEM INFORMATION TYPE 13 message is sent on BCCH norm
- 1 SYSTEM INFORMATION TYPE 13 message is sent on BCCH ext

**PBCCH\_LOCATION** (2 bit field)

The PBCCH\_LOCATION field, if present, indicates the location of the PBCCH on the BCCH carrier (see 3GPP TS 45.002). If the PBCCH location for a neighbour cell is given using this field, the TSC shall equal the BCC determined by the BSIC of that cell.

bit

2 1	
0 0	PBCCH on TN 1 of BCCH carrier
0 1	PBCCH on TN 2 of BCCH carrier
1 0	PBCCH on TN 3 of BCCH carrier
1 1	PBCCH on TN 4 of BCCH carrier

**PSI1\_REPEAT\_PERIOD** (4 bit field)

The PSI1\_REPEAT\_PERIOD field indicates the PSI repeat period. The field is coded according to the following table:

bit

4 3 2 1	
0 0 0 0	PSI1 repeat period = 1
0 0 0 1	PSI1 repeat period = 2
...	
1 1 1 1	PSI1 repeat period = 16

**LSA Parameters IE**

The LSA Parameters IE contains a list of LSA\_ID(s) corresponding to the entries in the Neighbour Cell Parameters. Some entries in LSA parameters may be empty. The entries in the LSA Parameters IE are listed in the same order as in the Neighbour Cell Parameters and the number of entries (nr\_of\_frequencies\_or\_cells) should be the same. In case there are too few entries in the LSA Parameters IE, empty entries shall be added at the end. In case there are too many entries in the LSA parameters, the last shall be discarded. The 'LSA parameters IE' is defined in sub-clause 12.28.

**LSA\_ID** (24 bit field)

The purpose of the LSA\_ID field is to identify a LSA. The LSA ID value field is coded as specified in 3GPP TS 23.003.

**Short LSA\_ID** (10 bit field)

The purpose of the Short LSA\_ID field is to identify a LSA. The LSA ID defined by the Short LSA\_ID is a LSA\_ID as specified in 3GPP TS 23.003 with bit 0 set to "0" bit 1 to 10 set to the value of the Short LSA\_ID field (LSB in bit 1, MSB in bit 10) and bit 11 to 23 set to "0".

**TIME\_GROUP** (2 bit field)

The TIME\_GROUP defines which time group (see 3GPP TS 45.002) the cell belongs to

bit	
2 1	
0 0	Time Group 0
0 1	Time Group 1
1 0	Time Group 2
1 1	Time Group 3

**GUAR\_CONSTANT\_PWR\_BLKs** (2 bit field)

This field indicates the guaranteed number of constant power blocks in the neighbour cell. These are the blocks that the MS can use to perform neighbour cell measurements (see 3GPP TS 45.008). Note that there may be more CPBCCCH blocks or allowed paging blocks in the neighbour cell than what is indicated in this field, but never less.

bit	
2 1	Blocks at constant power
0 0	4
0 1	5
1 0	6
1 1	12 (i.e. BS_PAG_BLKs_RES = 0 in that cell)

**Cell Identification**

This information element is defined in sub-clause 12.23.

**CCN Support Description****CCN\_SUPPORTED** (1 bit field)

This parameter is used for determining whether the mobile station shall enter CCN mode when re-selecting a cell and CCN is enabled. The use of these bits is described in sub-clause 8.8.2a ("CCN support description"):

Bit	
0	CCN is enabled towards the corresponding cell
1	CCN is disabled towards the corresponding cell

**CELL BAR QUALIFY 3** (2 bit field)

This information element is defined in 3GPP TS 44.018.

#### *Iu mode Neighbour Cell Parameters*

The *Iu mode Neighbour Cell Parameters* are used to specify *Iu mode* (and *A/Gb mode*) capable neighbouring cells (BA(GPRS)) and their corresponding cell selection parameters. The *Iu mode Neighbour Cell Parameters* are specified in PSI3 and in at least one instance of PSI3bis. If one instance of PSI3bis is not sufficient to specify the cell selection parameters of all *Iu mode* capable neighbouring cells, the remaining *Iu mode* capable neighbouring cells are specified in consecutive instances of PSI3bis. If all information fits within the PSI3 message, one instance of PSI3bis without any *Iu mode Neighbour Cell Parameters* is broadcast.

NOTE: For efficient coding, cells with common cell selection parameters may be grouped together.

Building of BA(GPRS) is defined in sub-clause 5.6.3.2.

#### *Iu mode Only Neighbour Cell Parameters*

The *Iu mode Only Neighbour Cell Parameters* are used to specify *Iu mode* only capable neighbouring cells and their corresponding cell selection parameters. The *Iu mode Only Neighbour Cell Parameters* are specified in PSI3 and in at least one instance of PSI3bis. If one instance of PSI3bis is not sufficient to specify the cell selection parameters of all *Iu mode* only capable neighbouring cells, the remaining *Iu mode* only capable neighbouring cells are specified in consecutive instances of PSI3bis. If all information fits within the PSI3 message, one instance of PSI3bis without any *Iu mode Only Neighbour Cell Parameters* is broadcast.

#### *Iu mode Neighbour Cell params struct*

This struct presents supplementary information for *Iu mode* capable cells. The struct may be included in this message and assigns *Iu mode* parameter values to the neighbouring cells defined by the message. *Iu mode* capable neighbouring cells are defined by the *Neighbour Cell Parameter IE*. The *Iu mode Neighbour Cell params struct* values are assigned to the neighbouring cells in the same order they appear in the PSI3 and PSI3bis messages.

## 11.2.21 Packet System Information Type 3 bis

This message is sent by the network on the PBCCH and PACCH giving information of the BCCH allocation in the neighbour cells and cell selection parameters for non-serving cells. This message shall not be segmented across more than one RLC/MAC control block by using the procedures specified in sub-clause 9.1.12a. If not all information fits into one instance of the PSI3bis message, the PSI3bis message can be repeated. Special requirements for the transmission of this message apply on PBCCH, see 3GPP TS 45.002.

Message type: PACKET SYSTEM INFORMATION TYPE 3 BIS

Direction: network to mobile station

Classification: distribution message

Table 11.2.21.1: PSI3 bis information elements

```

< PSI3 bis message content > ::=
  < PAGE_MODE : bit (2) >
  < PSI3_CHANGE_MARK : bit (2) >
  < PSI3_BIS_INDEX : bit (4) >
  < PSI3_BIS_COUNT : bit (4) >
  {
    < Neighbour cell parameters : { 1 < Neighbour cell params struct > } ** 0 >
    < Neighbour Cell parameters 2 : { 1 < Neighbour Cell params 2 struct > } ** 0 >
    {
      null | 0 bit** = < no string >
      | 1
      -- Release 1998 additions:
      { 0 | 1 < LSA Parameters : < LSA Parameters IE >> }
      {
        null | 0 bit** = < no string >
        | 1
        -- Release 1999 additions:
        < COMPACT Neighbour Cell Parameters : { 1 < COMPACT Neighbour Cell params 2 struct > } ** 0 >
        0
        -- The value '1' was used in an earlier version of the protocol and shall not be used.
        {
          null | 0 bit** = < no string >
          | 1
          -- Rel-4 additions:
          { 0 | 1 < CCN Support Description : < CCN Support Description struct >> }
          {
            null | 0 bit** = < no string >
            | 1
            -- Rel-5 additions:
            < lu Mode Neighbour Cell Parameters : { 1 < lu Mode Neighbour Cell params struct > } ** 0 >
            --Supplementary information for dual lu mode and A/Gb mode capable cells
            < lu mode Only Neighbour Cell Parameters :
              { 1 < lu mode Only Neighbour Cell params struct > } ** 0 >
            < padding bits > } } } // -- truncation at end of message allowed, bits '0' assumed
          ! < Distribution part error : bit (*) = < no string >> ;
    }
  }

< Neighbour cell params struct > ::=
  < START_FREQUENCY : bit (10) >
  < Cell selection params : < Cell Selection struct > >
  < NR_OF_REMAINING_CELLS : bit (4) >
  < FREQ_DIFF_LENGTH : bit (3) >
  {
    < FREQUENCY_DIFF : bit (1 + val(FREQ_DIFF_LENGTH)) >
    < Cell selection params : < Cell Selection struct > > } * (val(NR_OF_REMAINING_CELLS));

< Cell Selection struct > ::=
  < BSIC : bit (6) >
  < CELL_BAR_ACCESS_2 : bit >
  < EXC_ACC : bit >
  < SAME_RA_AS_SERVING_CELL : bit (1) >
  { 0 | 1 < GPRS_RXLEV_ACCESS_MIN : bit (6) >
    < GPRS_MS_TXPWR_MAX_CCH : bit (5) > }
  { 0 | 1 < GPRS_TEMPORARY_OFFSET : bit (3) >
    < GPRS_PENALTY_TIME : bit (5) > }
  { 0 | 1 < GPRS_RESELECT_OFFSET : bit (5) > }
  { 0 | 1 < HCS params : < HCS struct > > }
  { 0 | 1 < SI13_PBCCH_LOCATION : < SI13_PBCCH_LOCATION struct > > } ;

< SI13_PBCCH_LOCATION struct > ::=
  {
    0 < SI13_LOCATION : bit (1) >
    | 1 < PBCCH_LOCATION : bit (2) >
    < PSI1_REPEAT_PERIOD : bit (4) > } ;

< HCS struct > ::=
  < PRIORITY_CLASS : bit (3) >
  < HCS_THR : bit (5) > ;

< Neighbour Cell params 2 struct > ::=
  {
    00 -- Message escape
    { 1 < NCP2 Repeat struct >
      < CELL_PARAMS_POINTER : bit (2) > ** 0 --Up to four pointers to the 'Neighbour parameter set
      < Neighbour parameter set : < Neighbour parameter set struct > > * (1 + max(val(CELL_PARAMS_POINTER)))
      ! < Message escape: { 01 | 10 | 11 } bit** = < no string >> ; -- Reserved for future use
    }
  }

```

```

< NCP2 Repeat struct > ::=
    { 1 < START_FREQUENCY : bit (10) >          -- Multiple START_FREQ/FREQ DIFF sets may be defined
      < NCP2 Property struct >
      { < NR_OF_REMAINING_CELLS : { bit (4) - 0000 } >
        < FREQ_DIFF_LENGTH : bit (3) >
        { < FREQUENCY_DIFF : bit (1 + val(FREQ_DIFF_LENGTH)) >
          < NCP2 Property struct > } * (val(NR_OF_REMAINING_CELLS))
        < NCP2 Repeat struct >          -- Repeated recursively
        | 0000 }                      -- Break recursion (NR_OF_REMAINING_CELLS == 0)
      | 0 };                            -- End recursion (no more START_FREQUENCY)

< NCP2 Property struct > ::=
    < SAME_RA_AS_SERVING_CELL : bit (1) >
    < CELL_BAR_ACCESS_2 : bit >
    < BCC : bit (3) >;

< Neighbour parameter set struct > ::=
    { 0 | 1 < NCC : bit (3) > }
    < EXC_ACC : bit >
    { 0 | 1 < GPRS_RXLEV_ACCESS_MIN : bit (6) > }
    { 0 | 1 < GPRS_MS_TXPWR_MAX_CCH : bit (5) > }
    { 0 | 1 < PRIORITY_CLASS : bit (3) > }
    { 0 | 1 < HCS_THR : bit (5) > }
    { 0 | 1 < SI13_PBCCH_LOCATION : < SI13_PBCCH_LOCATION struct > > }
    < GPRS_TEMPORARY_OFFSET : bit (3) >
    < GPRS_PENALTY_TIME : bit (5) >
    < GPRS_RESELECT_OFFSET : bit (5) >;

< COMPACT Neighbour Cell params 2 struct > ::=
    { 00          -- Message escape
      { 1 < COMPACT NCP2 Repeat struct >
        < CELL_PARAMS_POINTER : bit (2) > } ** 0    -- Up to four pointers to the 'C Neighbour parameter set'
        < COMPACT Neighbour parameter set :
          < COMPACT Neighbour parameter set struct > * (1+ max(val(CELL_PARAMS_POINTER)))
        ! < Message escape: { 01 | 10 | 11 } bit** = < no string >> };    -- Reserved for future use

< COMPACT NCP2 Repeat struct > ::=
    { 1 < START_FREQUENCY : bit (10) >          -- Multiple START_FREQ/FREQ DIFF sets may be defined
      < COMPACT NCP2 Property struct >
      { < NR_OF_REMAINING_CELLS : { bit (4) - 0000 } >
        < FREQ_DIFF_LENGTH : bit (3) >
        { < FREQUENCY_DIFF : bit (1 + val(FREQ_DIFF_LENGTH)) >
          < COMPACT NCP2 Property struct > } * (val(NR_OF_REMAINING_CELLS))
        < COMPACT NCP2 Repeat struct >          -- Repeated recursively
        | 0000 }                      -- Break recursion (NR_OF_REMAINING_CELLS == 0)
      | 0 };                            -- End recursion (no more START_FREQUENCY)

< COMPACT NCP2 Property struct > ::=
    < SAME_RA_AS_SERVING_CELL : bit (1) >
    < CELL_BAR_ACCESS_2 : bit >
    < BCC : bit (3) >
    { 0 | 1 < TIME_GROUP : bit (2) > };

< COMPACT Neighbour parameter set struct > ::=
    { 0 | 1 < NCC : bit (3) > }
    < EXC_ACC : bit >
    { 0 | 1 < GPRS_RXLEV_ACCESS_MIN : bit (6) > }
    { 0 | 1 < GPRS_MS_TXPWR_MAX_CCH : bit (5) > }
    { 0 | 1 < GPRS_PRIORITY_CLASS : bit (3) > }
    { 0 | 1 < GPRS_HCS_THR : bit (5) > }
    < GPRS_TEMPORARY_OFFSET : bit (3) >
    < GPRS_PENALTY_TIME : bit (5) >
    < GPRS_RESELECT_OFFSET : bit (5) >
    { 0 | 1 < GUAR_CONSTANT_PWR_BLKs : bit (2) > };

```

```

< CCN Support Description struct > ::=
< Number_Cells : bit (7) >
{ CCN_SUPPORTED : bit } * (val(Number_Cells));

< lu mode neighbour cell params struct > ::=
  < NR_OF_REMAINING_CELLS : bit (4) >
  { 0 | 1 < lu Mode Cell Selection Params : <lu Mode Cell Selection struct >> } * (val(NR_OF_REMAINING_CELLS));

< lu Mode Cell Selection struct > ::=
  < CELL BAR QUALIFY 3 : bit (2) >
  { 0 | 1 < SI13Alt PBCCH Location: < SI13 PBCCH Location struct > > };

< lu mode Only Neighbour Cell params struct > ::=
  < START_FREQUENCY : bit (10) >
  < lu mode Only Cell selection params : < lu mode Only Cell Selection struct > >
  < NR_OF_REMAINING_CELLS : bit (4) >
  < FREQ_DIFF_LENGTH : bit (3) >
  { < FREQUENCY_DIFF : bit (1 + val(FREQ_DIFF_LENGTH)) >
    < lu mode Only Cell Selection params :
      < lu mode Only Cell Selection struct > > } * (val(NR_OF_REMAINING_CELLS));

< lu Mode Only Cell Selection struct > ::=
  < BSIC : bit (6) >
  < CELL BAR QUALIFY 3 : bit (2) >
  < SAME_RA_AS_SERVING_CELL : bit (1) >
  { 0 | 1 < GPRS_RXLEV_ACCESS_MIN : bit (6) >
    < GPRS_MS_TXPWR_MAX_CCH : bit (5) > }
  { 0 | 1 < GPRS_TEMPORARY_OFFSET : bit (3) >
    < GPRS_PENALTY_TIME : bit (5) > }
  { 0 | 1 < GPRS_RESELECT_OFFSET : bit (5) > }
  { 0 | 1 < HCS params : < HCS struct > > }
  { 0 | 1 < SI13Alt PBCCH Location : < SI13 PBCCH Location struct > > };

```

Table 11.2.21.2: PSI3 bis information element details

**PAGE\_MODE** (2 bit field)

See description under PSI3.

**PSI3\_CHANGE\_MARK** (2 bit field)

See description under PSI3.

**PSI3\_BIS\_INDEX** (4 bit field)

The **PSI3\_BIS\_INDEX** field is used to distinguish individual PSI3 bis messages containing information about different neighbour cells. The field can take the binary representation of the values 0 to n, where n is the index of the last PSI3 bis message. (PSI3 bis count).

**PSI3\_BIS\_COUNT** (4 bit field)

See description under PSI3.

**General rules for handling neighbour cell parameter default values**

The first neighbour cell defined in the first PSI3bis instance uses as its default parameter values the parameter values defined for the last neighbour cell in PSI3.

The following neighbour cells in PSI3bis use the parameter values of the previous neighbour cell as their default values.

This principle of referring to the previous cell applies independently of the coding used in PSI3bis (Neighbour cell parameters, Neighbour cell parameters 2 and COMPACT Neighbour Cell Parameters).

This principle also applies when going from PSI3bis instance i over to PSI3bis instance i+1.



<p><b><i>Neighbour cell params struct</i></b> The coding of the Neighbour cell parameters is described under PSI3.</p> <p><b><i>Neighbour cell params 2 struct</i></b> This coding may be used if the number of neighbour cells is high and many cells share common parameter values. The structure contains pointers to the list of sets of actual parameters. The coding of actual parameters that are contained in or referenced by the Neighbour Cell params 2 struct is described in PSI3.</p>
<p><b><i>COMPACT Neighbour Cell params struct</i></b> The coding of the Neighbour cell parameters is the same as the coding of the Neighbour cell params struct 2, except the two additional parameters, TIME_GROUP and GUAR_CONSTANT_PWR_BLKs. The coding of actual parameters that are contained in or referenced by the COMPACT Neighbour Cell params struct is described in PSI3.</p> <p>The following parameters (CELL_PARAMS_POINTER, BCC and NCC) are not defined in PSI3:</p> <p><b>CELL_PARAMS_POINTER</b> (2 bit field) Pointer to the parameter set valid for a certain cell group (up to four).</p> <p><b>BCC</b> (3 bit field) BTS Colour Code.</p>
<p><b><i>Neighbour parameter set struct and COMPACT Neighbour parameter set struct</i></b> The actual parameter values for the Neighbour Cell params 2 struct and the COMPACT Neighbour Cell params struct are given in these structures. Default values for absent parameters are defined according to the general rule given above, except:</p> <p><b>NCC</b> : bit (3). Network Colour Code. The default value is given by the serving cell.</p> <p><b>LSA Parameters IE</b> The LSA Parameters IE is described under PSI3 and in sub-clause 12.28.</p>
<p><b><i>CCN Support Description</i></b></p> <p><b>CCN_SUPPORTED</b> (1 bit field) This parameter is used for determining whether the mobile station shall enter CCN mode when re-selecting a cell and CCN is enabled. The use of these bits is described in sub-clause 8.8.2a: Bit  <b>0</b> CCN is enabled towards the corresponding cell  <b>1</b> CCN is disabled towards the corresponding cell</p>
<p><b>CELL BAR QUALIFY 3</b> (2 bit field) This information element is defined in 3GPP TS 44.018.</p>
<p><b><i>Iu mode Neighbour Cell params struct</i></b> This struct presents supplementary information for <i>Iu mode</i> capable cells. The struct may be included in this message and assigns <i>Iu mode</i> parameter values to the neighbouring cells defined by the message. <i>Iu mode</i> capable neighbouring cells may be defined by the <i>Neighbour Cell parameters</i> and the <i>Neighbour Cell parameters 2</i> IEs. The <i>Iu mode Neighbour Cell params struct</i> values are assigned to the neighbouring cells in the same order they appear in the PSI3 and PSI3bis messages.</p>

### 11.2.21a Packet System Information Type 3 ter

This message is sent by the network on the PBCCH or PACCH giving information on additional measurement and reporting parameters. This message shall not be segmented across more than one RLC/MAC control block by using the procedures specified in sub-clause 9.1.12a. If not all information fits into one instance of the PSI3ter message, the PSI3ter message can be repeated. Special requirements for the transmission of this message apply on PBCCH, see 3GPP TS 45.002.

Message type: PACKET SYSTEM INFORMATION TYPE 3 TER

Direction: network to mobile station

Classification: distribution message

**Table 11.2.21a.1: PSI3 ter information elements**

```

< PSI3 ter message content > ::=
  < PAGE_MODE : bit (2) >
  < PSI3_CHANGE_MARK : bit (2) >
  < PSI3_TER_INDEX : bit (4) >
  < PSI3_TER_COUNT : bit (4) >
  {
    { 0 | 1 < Real Time Difference Description : < Real Time Difference Description struct >> }
    { 0 | 1 < GPRS REP_PRIORITY Description : < GPRS REP PRIORITY Description struct >> }
    < padding bits > // -- truncation at end of message allowed, bits '0' assumed
  }
  ! < Distribution part error : bit (*) = < no string >> ;

< Real Time Difference Description struct > ::=
  { 0 | 1 { 0 | 1 < Cell_Index_Start_RTD : bit (7) > } -- default value=0
    < RTD Struct : < RTD6 Struct >>
    { 0 < RTD Struct : < RTD6 Struct >> } **1 } -- '0' : increment by 1 the index of the GSM Neighbour Cell list
  { 0 | 1 { 0 | 1 < Cell_Index_Start_RTD : bit (7) > } -- default value=0
    < RTD Struct : < RTD12 Struct >>
    { 0 < RTD Struct : < RTD12 Struct >> } **1 } ; -- '0' : increment by 1 the index of the GSM Neighbour Cell list

< RTD6 Struct > ::=
  { 0 | 1 < RTD : bit (6) > } ; -- '0' means no RTD for this cell

< RTD12 Struct > ::=
  { 0 | 1 < RTD : bit (12) > } ; -- '0' means no RTD for this cell

< GPRS REP_PRIORITY Description struct > ::=
  < Number_Cells : bit(7) >
  { < REP_PRIORITY : bit > } * (val(Number_Cells)) ;

```

**Table 11.2.21a.2: PSI3 ter information element details**

<p><b>PAGE_MODE</b> (2 bit field) See description under PSI3.</p>
<p><b>PSI3_CHANGE_MARK</b> (2 bit field) See description under PSI3.</p>
<p><b>PSI3_TER_INDEX</b> (4 bit field) The PSI3_TER_INDEX field is used to distinguish individual PSI3 bis messages containing information about different neighbour cells. The field can take the binary representation of the values 0 to n, where n is the index of the last PSI3 ter message. (PSI3 ter count).</p>
<p><b>PSI3_TER_COUNT</b> (4 bit field) This field is coded as the binary representation of the PSI3 ter index (in the PSI3 ter message) for the last (highest indexed) individual PSI3 ter message. Range: 0-15.</p>
<p><b>Real Time Difference Description</b></p> <p><b>Cell_Index_Start_RTD</b> (7 bit field) This field indicates the GSM Neighbour Cell list index for the first RTD parameter. When missing, the value '0' is assumed.</p> <p><b>RTD</b> (6 or 12 bit field) is defined in 3GPP TS 45.008. The use of these parameters is defined in sub-clause 5.6.3.4.</p>

***GPRS REP PRIORITY Description*****REP\_PRIORITY** bit:

- 0 Normal reporting priority
- 1 High reporting priority

The use of these bits is defined in sub-clause 5.6.3.5.

### 11.2.21a.1 GPRS REP PRIORITY description

A GPRS REP PRIORITY description construction shall be included in one and only one instance of the PACKET SYSTEM INFORMATION TYPE 3 TER message within the consistent set of PACKET SYSTEM INFORMATION TYPE 3 TER messages.

### 11.2.21b Packet System Information Type 3 quater

This message is sent by the network on the PBCCH or PACCH giving information on 3G Neighbour Cells and additional measurement and reporting parameters. This message shall not be segmented across more than one RLC/MAC control block by using the procedures specified in sub-clause 9.1.12a. If not all information fits into one instance of the PSI3quater message, the PSI3quater message can be repeated. Special requirements for the transmission of this message apply on PBCCH, see 3GPP TS 45.002.

Message type: PACKET SYSTEM INFORMATION TYPE 3 QUATER

Direction: network to mobile station

Classification: distribution message

Table 11.2.21b.1: PSI3 quater information elements

```

< PSI3 quater message content > ::=
  < PAGE_MODE : bit (2) >
  < PSI3_CHANGE_MARK : bit (2) >
  < PSI3_QUATER_INDEX : bit (4) >
  < PSI3_QUATER_COUNT : bit (4) >
  {
    { 0 | 1 < GPRS REP_PRIORITY Description : < GPRS REP PRIORITY Description struct >> }
    { 0 | 1 < 3G Neighbour Cells Description : < 3G Neighbour Cells Description struct >> }
    { 0 | 1 < 3G MEASUREMENT Parameters Description :
      < 3G MEASUREMENT PARAMETERS Description struct >> }
    { 0 | 1 < 3G Initial Dedicated Mode Reporting Description :
      < 3G Initial Dedicated Mode Reporting Description struct >> }
    {
      null | 0 bit** < no string >          -- Receiver compatible with earlier release
      | 1                                     -- Additions in Release 5:
      { 0 | 1 < GPRS 3G Additional Measurement Parameters Description :
        < GPRS 3G Additional Measurement Parameters Description struct >> }
      { 0 | 1 < GPRS 3G Additional Measurement Parameters Description 2:
        < GPRS 3G Additional Measurement Parameters Description 2 struct >> }
      {
        null | 0 bit** = < no string >      --Receiver compatible with earlier release
        | 1                                  --Additions in Release 6:
        < 3G_CCN_ACTIVE : bit >
        < padding bits > } } //              -- truncation at end of message allowed, bits '0' assumed ! <
  }
  Distribution part error : bit (*) = < no string > > ;

< GPRS REP PRIORITY Description struct > ::=
  < Number_Cells : bit(7) >
  { < REP_PRIORITY : bit > } * (val(Number_Cells)) ;

< 3G Neighbour Cell Description struct > ::=
  { 0 | 1 < Index_Start_3G : bit (7) > }
  { 0 | 1 < Absolute_Index_Start_EMR : bit (7) > }
  { 0 | 1 < UTRAN FDD Description : < UTRAN FDD Description struct >> }
  { 0 | 1 < UTRAN TDD Description : < UTRAN TDD Description struct >> } ;

< UTRAN FDD Description struct > ::=
  { 0 | 1 < Bandwidth_FDD : bit (3) > }
  { 1 < Repeated UTRAN FDD Neighbour Cells : < Repeated UTRAN FDD Neighbour Cells struct >> } ** 0 ;

< Repeated UTRAN FDD Neighbour Cells struct > ::=
  0 < FDD-ARFCN : bit (14) >  -- The value "1" was used in an earlier
                             -- version of the protocol and shall not be used.
  < FDD_Indic0 : bit >
  < NR_OF_FDD_CELLS : bit (5) >
  < FDD_CELL_INFORMATION Field : bit(p(NR_OF_FDD_CELLS)) > ;
                             -- p(x) defined in table 11.2.9b.2.a/3GPP TS 44.060

< UTRAN TDD Description struct > ::=
  { 0 | 1 < Bandwidth_TDD : bit (3) > }
  { 1 < Repeated UTRAN TDD Neighbour Cells : < Repeated UTRAN TDD Neighbour Cells struct >> } ** 0 ;

< Repeated UTRAN TDD Neighbour Cells struct > ::=
  0 < TDD-ARFCN : bit (14) >  -- The value "1" was used in an earlier
                             -- version of the protocol and shall not be used.
  < TDD_Indic0 : bit >
  < NR_OF_TDD_CELLS : bit (5) >
  < TDD_CELL_INFORMATION Field : bit(q(NR_OF_TDD_CELLS)) > ;
                             -- q(x) defined in table 11.2.9b.2.b/3GPP TS 44.060

< 3G MEASUREMENT PARAMETERS Description struct > ::=
  < Qsearch_P : bit (4) >
  { 1 ! < Ignore : bit = < no string >> }          -- this bit shall be ignored by the receiver
                                                  -- for backward compatibility with earlier releases
  { 0 | 1 < FDD_GPRS_Qoffset : bit (4) >          -- FDD information
    < FDD_Qmin : bit (3) > }
  { 0 | 1 < TDD_GPRS_Qoffset : bit (4) > } ;      -- TDD information

```

```

< 3G Initial Dedicated Mode Reporting Description struct > ::=
  < 3G_BA_IND : bit >
  < Qsearch_I : bit (4) >
  < Qsearch_C_Initial : bit (1) >
  { 0 | 1 < FDD_Qoffset : bit (4) >                               -- FDD information
    < FDD_REP_QUANT : bit (1) >
    < FDD_MULTIRAT_REPORTING : bit (2) > }
  { 0 | 1 < TDD_Qoffset : bit (4) >                               -- TDD information
    < TDD_MULTIRAT_REPORTING : bit (2) > };

< GPRS 3G Additional Measurement Parameters Description struct > ::=
  < FDD_Qmin_Offset : bit (3) >                                   -- FDD information
  < FDD_RSCPmin : bit (4) >;

< GPRS 3G Additional Measurement Parameters Description 2 struct > ::=
  { 0 | 1 < FDD_REPORTING_THRESHOLD_2 : bit (6) > };           -- FDD information

```

Table 11.2.21b.2: PSI3 quater information element details

<b>PAGE_MODE</b> (2 bit field) See description under PSI3.
<b>PSI3_CHANGE_MARK</b> (2 bit field) See description under PSI3.
<b>PSI3_QUATER_INDEX</b> (4 bit field) The PSI3_QUATER_INDEX field is used to distinguish individual PSI3 quater messages containing information about different neighbour cells. The field can take the binary representation of the values 0 to n, where n is the index of the last PSI3 quater message. (PSI3 quater count).
<b>PSI3_QUATER_COUNT</b> (4 bit field) This field is coded as the binary representation of the PSI3 quater index (in the PSI3 quater message) for the last (highest indexed) individual PSI3 quater message. Range: 0-15.
<b><i>GPRS REP PRIORITY Description</i></b>  <b>REP_PRIORITY</b> bit: 0 Normal reporting priority 1 High reporting priority  The use of these bits is defined in sub-clause 5.6.3.5 ("GPRS Report Priority Description").

**3G Neighbour Cell Description**

The building of the 3G Neighbour Cell list and the ordering of indices within each Radio Access Technology is described in sub-clause 5.6.3.1.

**Index\_Start\_3G** (7 bit)

This optional information element indicates the value of the first index to use to build this instance of the 3G Neighbour Cell list. When missing, the value 0 is assumed. See sub-clause 5.6.3.1.

**Absolute\_Index\_Start\_EMR** (7 bit)

This parameter indicates the value to be added to the indexes of the 3G Neighbour Cell list for reporting 3G Cells with the PACKET ENHANCED MEASUREMENT REPORT message (see sub-clause 5.6.3.3). If different values are received for this parameter in different instances of this message, the instance with the highest index shall be used. If this parameter is absent in all instances of the message, the value "0" shall be used.

NOTE: This parameter is not used for reporting 3G Cells with the PACKET MEASUREMENT REPORT message, see sub-clause 11.2.9.

**UTRAN FDD Description:**

For detailed element definitions see the Packet Measurement Order message with the following exception for the FDD\_CELL\_INFORMATION Field:

**FDD\_CELL\_INFORMATION Field** (p bit field)

If parameter *n* in table 11.2.9b.2.a is equal to 31, this indicates that the corresponding UARFCN shall be included in the GPRS 3G Cell Reselection list (see sub-clause 5.6.3.7); no index shall be allocated in the 3G Neighbour Cell list.

**UTRAN TDD Description:**

For detailed element definitions see the Packet Measurement Order message with the following exception for the TDD\_CELL\_INFORMATION Field:

**TDD\_CELL\_INFORMATION Field** (q bit field)

If parameter *m* in table 11.2.9b.2.b is equal to 31, this indicates that the corresponding UARFCN shall be included in the GPRS 3G Cell Reselection list (see sub-clause 5.6.3.7); no index shall be allocated in the 3G Neighbour Cell list.

**3G MEASUREMENT PARAMETERS Description**

The fields of this Description are used for measurements as defined in 3GPP TS 45.008.

**3G Initial Dedicated Mode Reporting Description**

These parameters shall only be used in initial 3G neighbour cell reporting in dedicated mode.

**3G\_BA\_IND** (1 bit field)

The 3G\_BA\_IND is needed to identify set of 3G Neighbour Cell information used for reporting in dedicated mode. The value received is reflected in the MEASUREMENT REPORT and ENHANCED MEASUREMENT REPORT messages, see 3GPP TS 44.018 'Parameters for Measurements and Reporting'.

The other fields of this Description are used for measurements as defined in 3GPP TS 45.008.

**GPRS 3G Additional Measurement Parameters Description**

The fields of this Description are used for measurements as defined in 3GPP TS 45.008.

If the *GPRS 3G Additional MeasurementParameters Description* is included in more than one instance of the PSI3quater message, the *GPRS 3G Additional MeasurementParameters Description* of the instance with the highest PSI3quater\_INDEX shall be used.

**3G\_CCN\_ACTIVE** (1 bit field)

This field indicates whether CCN is enabled towards 3G neighbouring cells. It is coded as follows:

- 0 CCN towards 3G cells is disabled in the cell.
- 1 CCN towards 3G cells is enabled in the cell.

***GPRS 3G Additional Measurement Parameters Description 2***

The fields of this Description are used for measurements as defined in 3GPP TS 45.008.

If the *GPRS 3G Additional Measurement Parameters Description 2* is included in more than one instance of the PSI3quater message, the *GPRS 3G Additional Measurement Parameters Description 2* of the instance with the highest PSI3quater\_INDEX shall be used.

**11.2.21b.1 GPRS REP PRIORITY description**

A GPRS REP PRIORITY description construction shall be included in one and only one instance of the PACKET SYSTEM INFORMATION TYPE 3 QUATER message within the consistent set of PACKET SYSTEM INFORMATION TYPE 3 QUATER messages.

**11.2.22 (void)****11.2.23 Packet System Information Type 5**

This optional message is sent by the network on the PBCCH giving information for measurement reporting and network controlled cell reselection. This message shall not be segmented across more than one RLC/MAC control block by using the procedures specified in sub-clause 9.1.12a. If not all information fits into one message, the remaining information will be sent in other instances of the PSI5 message. The message is sent on PBCCH only if so indicated in PSI1.

Message type: PACKET SYSTEM INFORMATION TYPE 5

Direction: network to mobile station

Classification: distribution message

Table 11.2.23.1: PSI5 information elements

```

< PSI5 message content > ::=
  < PAGE_MODE : bit (2) >
  < PSI5_CHANGE_MARK : bit (2) >
  < PSI5_INDEX : bit (3) >
  < PSI5_COUNT : bit (3) >
  { 0 | 1 < NC Measurement Parameters : < NC Measurement Parameters struct > > }
  0
  -- The value '1' was allocated in an earlier version of the protocol and shall not be used.
  {
    null | 0 bit** = <no string> -- Receiver backward compatible with earlier release
    | 1 -- Additional contents for R99
    { 0 | 1 < ENH Reporting Parameters : < ENH Reporting Parameters struct > > }
    {
      null | 0 bit** = <no string> -- Receiver compatible with earlier release
      | 1 -- Additions in Rel-5:
      { 0 | 1 < GPRS 3G Additional Measurement Parameters Description 2 :
        < GPRS 3G Additional Measurement Parameters Description 2 struct > > }
      {
        null | 0 bit** = <no string> -- Receiver compatible with earlier release
        | 1 -- Additions in Rel-7 :
        { 0 | 1 < 700_REPORTING_OFFSET : bit (3) >
          < 700_REPORTING_THRESHOLD : bit (3) > }
        { 0 | 1 < 810_REPORTING_OFFSET : bit (3) >
          < 810_REPORTING_THRESHOLD : bit (3) > }
        < padding bits > } } }
    ! < Distribution part error : bit (*) = <no string > > ;

< NC Measurement Parameters struct > ::=
  < NETWORK_CONTROL_ORDER : bit (2) >
  { 0 | 1 < NC_NON_DRX_PERIOD : bit (3) >
    < NC_REPORTING_PERIOD_I : bit (3) >
    < NC_REPORTING_PERIOD_T : bit (3) > } ;

< ENH Reporting parameters struct > ::=
  < Report_Type : bit >
  < REPORTING_RATE : bit >
  < INVALID_BSIC_REPORTING : bit >
  { 0 | 1 < NCC_PERMITTED : bit (8) > }
  { 0 | 1 < GPRS MEASUREMENT Parameters Description :
    < GPRS MEASUREMENT Parameters Description struct > > }
  { 0 | 1 < GPRS 3G MEASUREMENT Parameters Description :
    < GPRS 3G MEASUREMENT Parameters Description struct > > } ;

< GPRS MEASUREMENT PARAMETERS Description struct > ::=
  { 0 | 1 < MULTIBAND_REPORTING : bit (2) > }
  { 0 | 1 < SERVING_BAND_REPORTING : bit (2) > }
  { 0 | 1 < SCALE_ORD : bit (2) > }

  { 0 | 1 < 900_REPORTING_OFFSET : bit (3) >
    < 900_REPORTING_THRESHOLD : bit (3) > }

  { 0 | 1 < 1800_REPORTING_OFFSET : bit (3) >
    < 1800_REPORTING_THRESHOLD : bit (3) > }

  { 0 | 1 < 400_REPORTING_OFFSET : bit (3) >
    < 400_REPORTING_THRESHOLD : bit (3) > }

  { 0 | 1 < 1900_REPORTING_OFFSET : bit (3) >
    < 1900_REPORTING_THRESHOLD : bit (3) > }

  { 0 | 1 < 850_REPORTING_OFFSET : bit (3) >
    < 850_REPORTING_THRESHOLD : bit (3) > } ;

```



<b>&lt; GPRS 3G MEASUREMENT PARAMETERS Description struct &gt; ::=</b>	
{ 0   1 < <b>FDD_REP_QUANT</b> : bit > }	-- FDD Parameters
< <b>FDD_MULTIRAT_REPORTING</b> : bit (2) > }	
{ 0   1 < <b>FDD_REPORTING_OFFSET</b> : bit (3) > }	
< <b>FDD_REPORTING_THRESHOLD</b> : bit (3) > }	
{ 0   1 < <b>TDD_MULTIRAT_REPORTING</b> : bit (2) > }	-- TDD Parameters
{ 0   1 < <b>TDD_REPORTING_OFFSET</b> : bit (3) > }	
< <b>TDD_REPORTING_THRESHOLD</b> : bit (3) > } ;	
<b>&lt; GPRS 3G Additional Measurement Parameters 2 struct &gt; ::=</b>	
{ 0   1 < <b>FDD_REPORTING_THRESHOLD_2</b> : bit (6) > } ;	-- FDD Parameters

**Table 11.2.23.2: PSI5 information element details**

<p>The optional PSI5 message contains broadcast measurement parameters for Network Control (NC) measurements containing the NC Measurement Parameters. The NC Measurement parameters struct shall only exist in one instance of the PSI5 message. If the NC Measurement parameters struct is included in more than one instance, the value of the struct in the instance with the highest index shall be valid and all others shall be ignored.</p>												
<p><b>PAGE_MODE</b> (2 bit field) This field is defined in sub-clause 12.20.</p>												
<p><b>PSI5_CHANGE_MARK</b> (2 bit field) The <b>PSI5_CHANGE_MARK</b> field is changed each time information has been updated in any of the individual instances of the PSI5 message. A new value indicates that the mobile station shall re-read the information from all PSI5 messages. Range: 0 to 3. The coding of this field is network dependent.</p> <p><b>PSI5_INDEX</b> (3 bit field) and <b>PSI5_COUNT</b> (3 bit field) The purpose of the <b>PSI5_INDEX</b> field and the <b>PSI5_COUNT</b> field is to indicate the number of individual messages within the sequence of PSI5 messages and to assign an index to identify each one of them. The <b>PSI5_INDEX</b> field is binary coded, range: 0 to 7, and provides an index to identify the individual PSI5 message. The <b>PSI5_COUNT</b> field is binary coded, range: 0 to 7, and provides the <b>PSI5_INDEX</b> value for the last (highest indexed) message in the sequence of PSI5 messages.</p>												
<p><b>NETWORK_CONTROL_ORDER</b> (2 bit field) The <b>NETWORK_CONTROL_ORDER</b> field is coded according to the following table (for definition of NCx see 3GPP TS 45.008):</p> <table border="1"> <tr> <td>bit</td> <td></td> </tr> <tr> <td>2 1</td> <td></td> </tr> <tr> <td>0 0</td> <td>NC0</td> </tr> <tr> <td>0 1</td> <td>NC1</td> </tr> <tr> <td>1 0</td> <td>NC2</td> </tr> <tr> <td>1 1</td> <td>Reserved</td> </tr> </table> <p>If the <b>NETWORK_CONTROL_ORDER</b> parameter = NC0, then the other parameters in the NC Measurement parameters struct may be omitted. If the <b>NETWORK_CONTROL_ORDER</b> parameter indicates NC1 or NC2 and the other parameters are omitted, the default value for these parameters shall be assumed.</p>	bit		2 1		0 0	NC0	0 1	NC1	1 0	NC2	1 1	Reserved
bit												
2 1												
0 0	NC0											
0 1	NC1											
1 0	NC2											
1 1	Reserved											

<p><b>NC_NON_DRX_PERIOD</b> (3 bit field)</p> <p>This field indicates the minimum time the mobile station shall stay in non-DRX mode after an NC-measurement report has been sent. The field is coded according to the following table:</p> <table> <tr><td>bit</td><td></td></tr> <tr><td>3 2 1</td><td></td></tr> <tr><td>0 0 0</td><td>No non-DRX mode after a measurement report has been sent.</td></tr> <tr><td>0 0 1</td><td>0,24 s</td></tr> <tr><td>0 1 0</td><td>0,48 s (<i>default value</i>)</td></tr> <tr><td>0 1 1</td><td>0,72 s</td></tr> <tr><td>1 0 0</td><td>0,96 s</td></tr> <tr><td>1 0 1</td><td>1,20 s</td></tr> <tr><td>1 1 0</td><td>1,44 s</td></tr> <tr><td>1 1 1</td><td>1,92 s</td></tr> </table>	bit		3 2 1		0 0 0	No non-DRX mode after a measurement report has been sent.	0 0 1	0,24 s	0 1 0	0,48 s ( <i>default value</i> )	0 1 1	0,72 s	1 0 0	0,96 s	1 0 1	1,20 s	1 1 0	1,44 s	1 1 1	1,92 s
bit																				
3 2 1																				
0 0 0	No non-DRX mode after a measurement report has been sent.																			
0 0 1	0,24 s																			
0 1 0	0,48 s ( <i>default value</i> )																			
0 1 1	0,72 s																			
1 0 0	0,96 s																			
1 0 1	1,20 s																			
1 1 0	1,44 s																			
1 1 1	1,92 s																			
<p><b>NC_REPORTING_PERIOD_I</b> (3 bit field)</p> <p><b>NC_REPORTING_PERIOD_T</b> (3 bit field)</p> <p>These fields indicate the time period for cell reselection measurement reporting for packet idle mode (I) and packet transfer mode (T), respectively. The field is coded according to the following table:</p> <table> <tr><td>bit</td><td></td></tr> <tr><td>3 2 1</td><td></td></tr> <tr><td>0 0 0</td><td>0,48 s</td></tr> <tr><td>0 0 1</td><td>0,96 s</td></tr> <tr><td>0 1 0</td><td>1,92 s</td></tr> <tr><td>0 1 1</td><td>3,84 s (<i>default value for NC_REPORTING_PERIOD_T</i>)</td></tr> <tr><td>1 0 0</td><td>7,68 s</td></tr> <tr><td>1 0 1</td><td>15,36 s</td></tr> <tr><td>1 1 0</td><td>30,72 s</td></tr> <tr><td>1 1 1</td><td>61,44 s (<i>default value for NC_REPORTING_PERIOD_I</i>)</td></tr> </table>	bit		3 2 1		0 0 0	0,48 s	0 0 1	0,96 s	0 1 0	1,92 s	0 1 1	3,84 s ( <i>default value for NC_REPORTING_PERIOD_T</i> )	1 0 0	7,68 s	1 0 1	15,36 s	1 1 0	30,72 s	1 1 1	61,44 s ( <i>default value for NC_REPORTING_PERIOD_I</i> )
bit																				
3 2 1																				
0 0 0	0,48 s																			
0 0 1	0,96 s																			
0 1 0	1,92 s																			
0 1 1	3,84 s ( <i>default value for NC_REPORTING_PERIOD_T</i> )																			
1 0 0	7,68 s																			
1 0 1	15,36 s																			
1 1 0	30,72 s																			
1 1 1	61,44 s ( <i>default value for NC_REPORTING_PERIOD_I</i> )																			
<p><b>NCC_PERMITTED</b> (8 bit field)</p> <p>This field is a bitmap of NCCs for which the mobile station is permitted to report measurement; this bitmap relates to NCC part of BSIC (see coding field in 3GPP TS 44.018).</p>																				
<p><b>ENH Reporting Parameters (Enhanced Measurement reporting parameters)</b></p> <p><b>Report_Type</b> (1bit)</p> <p>This parameter is used to indicate to the mobile station to use the PACKET ENHANCED MEASUREMENT REPORT message or the PACKET MEASUREMENT REPORT message for (NC) reporting:</p> <table> <tr><td>Bit</td><td></td></tr> <tr><td>0</td><td>The MS shall use the PACKET ENHANCED MEASUREMENT REPORT message for (NC) reporting</td></tr> <tr><td>1</td><td>The MS shall use the PACKET MEASUREMENT REPORT message for (NC) reporting.</td></tr> </table>	Bit		0	The MS shall use the PACKET ENHANCED MEASUREMENT REPORT message for (NC) reporting	1	The MS shall use the PACKET MEASUREMENT REPORT message for (NC) reporting.														
Bit																				
0	The MS shall use the PACKET ENHANCED MEASUREMENT REPORT message for (NC) reporting																			
1	The MS shall use the PACKET MEASUREMENT REPORT message for (NC) reporting.																			
<p><b>REPORTING_RATE</b> (1 bit)</p> <p>This parameter is used for measurements, see 3GPP TS 45.008.</p> <table> <tr><td>Bit</td><td></td></tr> <tr><td>0</td><td>normal rate reporting</td></tr> <tr><td>1</td><td>Reduced reporting rate allowed.</td></tr> </table>	Bit		0	normal rate reporting	1	Reduced reporting rate allowed.														
Bit																				
0	normal rate reporting																			
1	Reduced reporting rate allowed.																			
<p><b>INVALID_BSIC_REPORTING</b> (1 bit)</p> <p>This field specifies if cells with invalid BSIC and allowed NCC part of BSIC are allowed to be reported or not, see 3GPP TS 45.008.</p> <table> <tr><td>Bit</td><td></td></tr> <tr><td>0</td><td>Report on cells with invalid BSIC and allowed NCC part of BSIC is not allowed.</td></tr> <tr><td>1</td><td>Report on cells with invalid BSIC and allowed NCC part of BSIC is allowed. In this case NCC_PERMITTED is required.</td></tr> </table>	Bit		0	Report on cells with invalid BSIC and allowed NCC part of BSIC is not allowed.	1	Report on cells with invalid BSIC and allowed NCC part of BSIC is allowed. In this case NCC_PERMITTED is required.														
Bit																				
0	Report on cells with invalid BSIC and allowed NCC part of BSIC is not allowed.																			
1	Report on cells with invalid BSIC and allowed NCC part of BSIC is allowed. In this case NCC_PERMITTED is required.																			
<p><b>GPRS MEASUREMENT PARAMETERS Description</b></p> <p>The fields of this Description are used for measurements as defined in 3GPP TS 45.008.</p>																				

<p><b><i>GPRS 3G MEASUREMENT PARAMETERS Description</i></b> The fields of this Description are used for measurements as defined in 3GPP TS 45.008.</p>
<p><b><i>GPRS 3G Additional Measurement Parameters 2 Description</i></b> The fields of this Description are used for measurements, as defined in 3GPP TS 45.008.</p>
<p><b>700_REPORTING_OFFSET</b> (3 bit field) <b>700_REPORTING_THRESHOLD</b> (3 bit field) These fields are used for measurements, as defined in 3GPP TS 45.008.</p>
<p><b>810_REPORTING_OFFSET</b> (3 bit field) <b>810_REPORTING_THRESHOLD</b> (3 bit field) These fields are used for measurements, as defined in 3GPP TS 45.008.</p>

### 11.2.23a Packet System Information Type 6

This optional message is sent by the network on the PBCCH or PACCH to provide broadcast information required by non-GSM networks. This message shall not be segmented across more than one RLC/MAC control block by using the procedures specified in sub-clause 9.1.12a. If not all information fits into one instance of the PSI6 message, the PSI6 message can be repeated.. Special requirements for the transmission of this message apply on PBCCH, see 3GPP TS 45.002.

Message type: PACKET SYSTEM INFORMATION TYPE 6

Direction: network to mobile station

Classification: distribution message

**Table 11.2.23a.1: PSI6 information elements**

<pre> &lt; PSI6 message content &gt; ::=   &lt; PAGE_MODE : bit (2) &gt;   &lt; PSI6_CHANGE_MARK : bit (2) &gt;   &lt; PSI6_INDEX : bit (3) &gt;   &lt; PSI6_COUNT : bit (3) &gt;   { { &lt; NonGSM Message : &lt; Non-GSM Message struct &gt; &gt; **       -- The Non-GSM Message struct is repeated until:       { &lt; spare bit &gt; * 3    00000 }      -- A) val(NR_OF_CONTAINER_OCTETS) = 0, or       &lt; padding bits &gt; } //              -- B) the PSI message is fully used     ! &lt; Distribution part error : bit (*) = &lt; no string &gt; &gt; ;  &lt; NonGSM Message struct &gt; ::=   &lt; NonGSM Protocol Discriminator : bit(3) &gt;   &lt; NR_OF_CONTAINER_OCTETS : bit(5) exclude 00000 &gt;   { &lt; CONTAINER : bit(8) &gt; } * (val(NR_OF_CONTAINER_OCTETS)) ; </pre>
--

**Table 11.2.23a.2: PSI6 information element details**

<p><b>PAGE_MODE</b> (2 bit field) This field is defined in sub-clause 12.20.</p>
<p><b>PSI6_CHANGE_MARK</b> (2 bit field)</p> <p>The PSI6 change mark field is changed each time information has been updated in any of the PSI6 messages. A new value indicates that the mobile station shall re-read the information from the PSI6 message. The coding of this field is network dependent.</p> <p>Range: 0-3.</p>

<p><b>PSI6_INDEX</b> (3 bit field) and <b>PSI6_COUNT</b> (3 bit field)</p> <p>The purpose of the PSI6_INDEX field and the PSI6_COUNT field is to indicate the number of individual messages within the sequence of PSI6 messages and to assign an index to identify each one of them. The PSI6_INDEX field is binary coded, range: 0 to 7, and provides an index to identify the individual PSI6 message. The PSI6_COUNT field is binary coded, range: 0 to 7, and provides the PSI6_INDEX value for the last (highest indexed) message in the sequence of PSI6 messages.</p>
<p><b>NonGSM Protocol Discriminator</b> (3 bit field)</p> <p>This information element is used to identify the non-GSM network for which a PSI6 message is transmitted and is coded as shown below.</p> <p>Bit 3 2 1</p> <p>0 0 1 TIA/EIA-136</p> <p>All other values are reserved</p>
<p><b>NR_OF_CONTAINER_OCTETS</b> (5 bit field)</p> <p>This field indicates the number of CONTAINER octets that forms a specific non-GSM message and is coded as shown below.</p> <p>Bit 5 4 3 2 1</p> <p>0 0 0 0 1 CONTAINER length is 1 octet</p> <p>0 0 0 1 0 CONTAINER length is 2 octets</p> <p>.... through ...</p> <p>1 0 0 1 1 CONTAINER length is 19 octets</p> <p>1 1 1 1 1 The remaining portion of the PSI message is used by the associated CONTAINER. The Non-GSM message continues in a subsequent instance of the PSI message, in the next CONTAINER with the same Non-GSM Protocol Discriminator value as the current one.</p> <p>All other values are reserved.</p>
<p><b>CONTAINER</b> (8 bits)</p> <p>The concatenation of one or several CONTAINER octets forms the actual contents, specific to the non-GSM network soliciting the transmission of a PSI6 message.</p>

### 11.2.23b Packet System Information Type 7

This optional message is sent by the network on the PBCCH or PACCH to provide broadcast information required by non-GSM networks. This message shall not be segmented across more than one RLC/MAC control block by using the procedures specified in sub-clause 9.1.12a. If not all information fits into one instance of the PSI7 message, the PSI7 message can be repeated.. Special requirements for the transmission of this message apply on PBCCH, see 3GPP TS 45.002.

Message type: PACKET SYSTEM INFORMATION TYPE 7

Direction: network to mobile station

Classification: distribution message

The PSI7 information elements are equal to the PSI6 elements defined in sub-clause 11.2.23a.

### 11.2.24 Packet System Information Type 8

This message is optionally sent by the network on the PBCCH and PACCH giving information about Cell Broadcast Channel configuration and Dynamic ARFCN Mapping. This message shall not be segmented across more than one RLC/MAC control block by using the procedures specified in sub-clause 9.1.12a. Special requirements for the transmission of this message apply on PBCCH, see 3GPP TS 45.002.

Message type: PACKET SYSTEM INFORMATION TYPE 8

Direction: network to mobile station

Classification: distribution message

**Table 11.2.24.1: PSI8 information elements**

```

< PSI8 message content > ::=
  < PAGE_MODE : bit (2) >
  < PSI8_CHANGE_MARK : bit (2) >
  < PSI8_INDEX : bit (3) >
  < PSI8_COUNT : bit (3) >
  { 0 | 1 < CBCH Channel Description : < CBCH Channel Description struct > > }
  { null | 0 bit** = < no string >
    | 1
      -- Release 4 additions:
      { 0 | 1 < Dynamic ARFCN Mapping Description : < Dynamic ARFCN Mapping Description struct > > }
      < padding bits > }
  ! < Distribution part error : bit (*) = < no string > > ;

< CBCH Channel Description struct > ::=
  < Channel type and TDMA offset : bit (5) >
  < TN : bit (3) >
  < Frequency Parameters : < Frequency Parameters IE > > ;

< Dynamic ARFCN Mapping Description struct > ::=
  { 0 | 1 < DM_CHANGE_MARK : bit (4) > }
  { 1 < DYNAMIC ARFCN MAPPING > } ** 0 ;

< DYNAMIC ARFCN MAPPING > ::=
  < GSM_Band : bit (4) >
  < ARFCN_FIRST : bit (10) >
  < BAND_OFFSET : bit (10) >
  < ARFCN_RANGE : bit (7) > ;
  - - Dynamic ARFCN mapping parameters

```

**Table 11.2.24.2: PSI8 information element details**

<p><b>PAGE_MODE</b> (2 bit field) This field is defined in sub-clause 12.20.</p> <p><b>PSI8_INDEX</b> (3 bit field) and <b>PSI8_COUNT</b> (3 bit field) These fields are the binary representation of the PSI <i>index</i> and PSI <i>count</i> parameters associated with the PSI8 messages.</p> <p><b>PSI8_CHANGE_MARK</b> (2 bit field) The PSI8 change mark field is changed each time information has been updated in the PSI8 message. A new value indicates that the mobile station shall re-read the information from the PSI8 message. The coding of this field is network dependent. Range: 0-3.</p>
<p><b>CBCH Channel Description struct</b> The CBCH Channel Description provides the description for the CBCH. If the CBCH Channel Description is not available (either as it is not included in any instance of PSI8 or as no PSI8 is broadcast at all), the mobile station can assume that SMSCB is not active in the cell. If available, the CBCH Channel Description construction shall be included in one and only one instance of the PSI8 message within the consistent set of PSI8 messages</p> <p><b>Channel type and TDMA offset</b> (5 bit field) For encoding and description see 3GPP TS 44.018 .</p> <p><b>TN</b>, Timeslot number(3 bit field) The TN field is coded as the binary representation of the timeslot number as defined in 3GPP TS 45.002.</p> <p><b>Frequency Parameters</b> This information element is defined in sub-clause 12.8.</p>

**DM\_CHANGE\_MARK** (4 bit field), Dynamic ARFCN Mapping Change Mark.

This parameter is used to indicate to the MS a change of information concerning Dynamic ARFCN Mapping. This field shall be present in only one instance of Dynamic ARFCN Mapping Description struct in a consistent set of PSI8 messages.

Dynamic ARFCN Mapping parameters description:

These parameters allow to allocate ARFCN values and then dynamically map to physical frequencies, see 3GPP TS 45.005. The parameters of this description are defined in 3GPP TS 44.018.

If the mobile station receives more than 8 DYNAMIC\_ARFCN\_MAPPING structures, it shall store at least the 8 first structures in the order of occurrence, starting with the PSI8 instance with the lowest index number.

### 11.2.25 Packet System Information 13

This message may be broadcast by the network on the PACCH or on the PCCCH (see sub-clause 5.5.2.1). The message provides the mobile station with GPRS cell specific access-related information. The information in this message shall be the same as provided in the SI13 message on BCCH, see 3GPP TS 44.018. This message shall not be segmented across more than one RLC/MAC control block by using the procedures specified in sub-clause 9.1.12a.

Message type: PACKET SYSTEM INFORMATION TYPE 13

Direction: network to mobile station

Classification: distribution message

Table 11.2.25.1: PSI13 information elements

```

< PSI13 message content > ::=
  < PAGE_MODE : bit (2) >
  < BCCH_CHANGE_MARK : bit (3) >
  < SI_CHANGE_FIELD : bit (4) >
  { 0 | 1 < SI13_CHANGE_MARK : bit (2) >
    < GPRS Mobile Allocation : < GPRS Mobile Allocation IE > >
  }
  { 0
    -- PBCCH not present in cell (This shall always be indicated. See sub-clause 1.6):
    < RAC : bit (8) >
    < SPGC_CCCH_SUP : bit >
    < PRIORITY_ACCESS_THR : bit (3) >
    < NETWORK_CONTROL_ORDER : bit (2) >
    < GPRS Cell Options : < GPRS Cell Options IE > >
    < GPRS Power Control Parameters : < GPRS Power Control Parameters IE > >
  | 1
    -- PBCCH present in cell (This shall never be indicated. See sub-clause 1.6):
    < PSI_REPEAT_PERIOD : bit (4) >
    < PBCCH Description : < PBCCH Description struct > >
  }
  { null | 0 bit** = < no string > -- Receiver compatible with earlier release
  | 1 -- Additions in release 99 :
    < SGSNR : bit >
    { null | 0 bit** = < no string > -- Receiver compatible with earlier release
    | 1 -- Additions in release R4 :
      < SI_STATUS_IND : bit >
      { null | 0 bit** = < no string > -- Receiver compatible with earlier release
      | 1 -- Additions in Rel-6:
        { 0 | 1 < LB_MS_TXPWR_MAX_CCH : bit (5) > }
        < SI2n_SUPPORT : bit (2) >
        { null | 0 bit** = < no string > -- Receiver compatible with earlier release
        | 1 -- Additions in Rel-11:
          < SI_CHANGE_ALT : bit >
          < padding bits > } } }
  }
  ! < Distribution part error : bit (*) = < no string > > ;

< PBCCH Description struct > ::=
  < Pb : bit (4) >
  < TSC : bit (3) >
  < TN : bit (3) >
  { 0 -- default to BCCH carrier
  | 10 < ARFCN : bit (10) >
  | 11 < MAIO : bit (6) > };

```

Table 11.2.25.2: PSI13 information element details

**PAGE\_MODE** (2 bit field)

This field describes which type of page mode used, i.e. either normal paging, extended paging, paging reorganization or same as before from the previous page mode. The mobile station shall ignore this field if the message is received on the PACCH. Coding of this field is defined in 3GPP TS 44.018.

**BCCH\_CHANGE\_MARK** (3 bit field)

This field indicates the status of the information on BCCH. The value of this field shall be changed each time the information on BCCH, except for the contents of the SI-13 message, is changed.

**SI\_CHANGE\_FIELD** (4 bit field)

This field is the binary representation of which information was changed at the last indication in BCCH\_CHANGE\_MARK. Range 0 to 15:

bit

4 3 2 1

- 0 0 0 0 Update of *unspecified* SI message or SI messages;
- 0 0 0 1 Update of SI1 message;
- 0 0 1 0 Update of SI2, SI2 bis or SI2 ter message or any instance of SI2quater messages;
- 0 0 1 1 Update of SI3, SI4, SI7, SI8, SI16 or SI17 message;
- 0 1 0 0 Update of SI9 message;
- 0 1 0 1 Update of SI18 or SI20 message;
- 0 1 1 0 Update of SI19 message; 0 1 1 1 Update of SI15 message;
- 1 0 0 0 Update of SI2n message;
- 1 0 0 1 Update of SI22 or SI23 message;

All other values shall be interpreted as 'update of unknown SI message type'.

**SI13\_CHANGE\_MARK** (2 bit field)

This field is the binary representation of the SI change mark identifying the GPRS Mobile Allocation provided in SI13 and PSI13 messages.

Range: 0 to 3.

**GPRS Mobile Allocation** (information element)

This information element is the representation of the GPRS mobile allocation provided in SI13 and PSI13 messages. It is identified by MA\_NUMBER = 14 when referenced from a packet assignment message. When used in SI13 or PSI13 message, this information element shall refer to the cell allocation defined for the cell in SI1 or PSI2.

**RAC** (8 bit field)

This field is the binary representation of the Routing Area Code, see 3GPP TS 23.003.

**SPGC\_CCCH\_SUP** (bit field)

This field indicates the support of the parameter SPLIT\_PG\_CYCLE on CCCH from the network side:

- 0 SPLIT\_PG\_CYCLE is not supported on CCCH in this cell;
- 1 SPLIT\_PG\_CYCLE is supported on CCCH in this cell.

The **PRIORITY\_ACCESS\_THR** field (3 bit) is the binary representation of the parameter PRIORITY\_ACCESS\_THR:

bit

3 2 1

- 0 0 0 packet access is not allowed in the cell;
- 0 0 1 spare, shall be interpreted as '000' (packet access not allowed);
- 0 1 0 spare, shall be interpreted as '000' (packet access not allowed);
- 0 1 1 packet access is allowed for priority level 1;
- 1 0 0 packet access is allowed for priority level 1 to 2;
- 1 0 1 packet access is allowed for priority level 1 to 3;
- 1 1 0 packet access is allowed for priority level 1 to 4;
- 1 1 1 spare, shall be interpreted as '110' (packet access allowed).

The **NETWORK\_CONTROL\_ORDER** field (2 bit) is the binary representation of the parameter NETWORK\_CONTROL\_ORDER, see 3GPP TS 45.008:

bit

2 1

- 0 0 NC0: MS controlled cell re-selection, no measurement reporting.
- 0 1 NC1: MS controlled cell re-selection, MS sends measurement reports.
- 1 0 NC2: Network controlled cell re-selection, MS sends measurement reports.
- 1 1 Reserved for future use, interpreted as NC0 by mobile station.

**GPRS Cell Options** (information element)

The *GPRS Cell Option* information element is defined in sub-clause 12.24.



<p><b>PSI1_REPEAT_PERIOD</b> (4 bit field) This field is the representation of the PSI1 repeat period. The field is coded according to the following table:</p> <table> <tr><td>bit</td><td></td></tr> <tr><td>4 3 2 1</td><td></td></tr> <tr><td>0 0 0 0</td><td>PSI1 repeat period = 1 multiframe</td></tr> <tr><td>0 0 0 1</td><td>PSI1 repeat period = 2 multiframe</td></tr> <tr><td>:</td><td></td></tr> <tr><td>1 1 1 1</td><td>PSI1 repeat period = 16 multiframe</td></tr> </table>	bit		4 3 2 1		0 0 0 0	PSI1 repeat period = 1 multiframe	0 0 0 1	PSI1 repeat period = 2 multiframe	:		1 1 1 1	PSI1 repeat period = 16 multiframe
bit												
4 3 2 1												
0 0 0 0	PSI1 repeat period = 1 multiframe											
0 0 0 1	PSI1 repeat period = 2 multiframe											
:												
1 1 1 1	PSI1 repeat period = 16 multiframe											
<p><b>GPRS Power Control Parameters</b> (information element) The <i>GPRS Power Control Parameters</i> information element is defined in sub-clause 12.09a.</p>												
<p><b>PBCCH Description struct</b> The PBCCH description struct provides the channel description for the PBCCH. The frequency description for the PBCCH may be specified by an ARFCN (non-hopping radio frequency channel) or a MAIO (hopping radio frequency channel) field. In case of a hopping radio frequency channel, the PBCCH shall use the GPRS mobile allocation specified in this message. If none of the ARFCN or MAIO fields are present, the PBCCH shall use the BCCH carrier.</p>												
<p><b>Pb</b> (4 bit field) For encoding and description see the Global Power Control Parameters IE.</p>												
<p><b>TSC</b> (3 bit field) This field is the binary representation of the training sequence code used for PBCCH. Range: 0 to 7.</p>												
<p><b>TN</b> (3 bit field) This field is the binary representation of the timeslot number for the PBCCH. Range: 0 to 7.</p>												
<p><b>ARFCN</b> (10 bit field) This field is the binary representation of the absolute RF channel number. Range: 0 to 1023.</p>												
<p><b>MAIO</b> (6 bit field) This field is the binary representation of the mobile allocation index offset. Range: 0 to 63.</p>												
<p><b>SGSNR</b> (bit field) This field indicates the Release of the SGSN: 0 SGSN is Release '98 or older 1 SGSN is Release '99 onwards.</p>												
<p><b>SI_STATUS_IND</b> (1 bit field): 0 The network does not support the PACKET SI STATUS message; 1 The network supports the PACKET SI STATUS message.</p>												
<p><b>LB_MS_TXPWR_MAX_CCH</b> (5 bit field)  The LB_MS_TXPWR_MAX_CCH field is coded as the binary representation of the 'power control level' in 3GPP TS 45.005 corresponding to the maximum TX power level a mobile station may use when accessing on a packet control channel. This value shall be used by the mobile station according to 3GPP TS 45.008.</p>												
<p><b>SI2n_SUPPORT</b> (2 bit field) This field indicates the support of SI2n in the network, see 3GPP TS 44.018.</p>												
<p><b>SI_CHANGE_ALT</b> (1 bit field) This field indicates how a mobile station supporting network sharing shall take into account a change of system information signalled by a SI_CHANGE_FIELD value '0010':  0 A mobile station supporting network sharing should not attempt to re-read the SI2quater message; 1 A mobile station supporting network sharing shall fully take into account a change of system information signalled by the SI_CHANGE_FIELD value '0010', SI2quater included.</p>												

## 11.2.25a Packet System Information 14

This message may be sent by the network on the PACCH. The message may provide a mobile station in dual transfer mode or the in Network Assisted Cell Change procedure with GPRS access-related information. The information may be used as a substitute for the SI13 (and in some cases, the SI1) message on BCCH after the release of an RR connection, see 3GPP TS 44.018. This message may also be used during dual transfer mode to inform the mobile station about possible changes in the SI or PSI messages. This message may also be used in the network assisted cell change procedure when the target cell has PBCCH present.

Message type: PACKET SYSTEM INFORMATION TYPE 14

Direction: network to mobile station

Classification: distribution message

**Table 11.2.25a.1: PSI14 information elements**

<pre> &lt; PSI14 message content &gt; ::=   &lt; PAGE_MODE : bit (2) &gt;   { 0 &lt; CCCH Access Information : &lt; CCCH Access Information struct &gt;&gt; -- This information shall always be     included. See sub-clause 1.6.          1 &lt; PBCCH Description : &lt; PBCCH Description struct 2 &gt;&gt; -- This information shall never be included. See     sub-clause 1.6.     &lt; padding bits &gt; }   ! &lt; Distribution part error : bit (*) = &lt; no string &gt;&gt; ; </pre>
<pre> &lt; CCCH Access Information struct &gt; ::=   &lt; BCCH_CHANGE_MARK : bit (3) &gt;   { 0   1 &lt; SI13_CHANGE_MARK : bit (2) &gt;     &lt; SI13 Mobile Allocation : &lt; GPRS Mobile Allocation IE &gt;&gt; }   &lt; SPGC_CCCH_SUP : bit &gt;   &lt; PRIORITY_ACCESS_THR : bit (3) &gt;   &lt; NETWORK_CONTROL_ORDER : bit (2) &gt;   &lt; GPRS Cell Options : &lt; GPRS Cell Options IE &gt;&gt;   &lt; GPRS Power Control Parameters : &lt; GPRS Power Control Parameters struct &gt;&gt;   &lt; SGSNR : bit &gt;   { null   0 bit ** = &lt; no string &gt; -- Receiver backward compatible with earlier version       1 -- Additions for Dual Transfer Mode     0 -- compatible with earlier version     &lt; RAC : bit (8) &gt;     &lt; SI_STATUS_IND : bit &gt;     { null   0 bit ** = &lt; no string &gt; -- Receiver backward compatible with earlier version         1 -- Additions for Rel-6       { 0   1 &lt; LB_MS_TXPWR_MAX_CCH : bit (5) &gt; }       &lt; SI2n_SUPPORT : bit (2) &gt;     }   } }; </pre>
<pre> &lt; PBCCH Description struct 2 &gt; ::=   &lt; PSI_REPEAT_PERIOD : bit (4) &gt;   &lt; Pb : bit (4) &gt;   &lt; TN : bit (3) &gt;   &lt; PBCCH Frequency Description : &lt; Frequency Parameters IE &gt;&gt;   { null   0 bit ** = &lt; no string &gt; -- Receiver backward compatible with earlier version       1 -- Additions for Dual Transfer Mode     1 -- compatible with earlier version     &lt; PSI_CHANGED_IND : bit &gt;   } }; </pre>

Table 11.2.25a.2: PSI14 information element details

<b>PAGE_MODE</b> (2 bit field) This field is defined in sub-clause 12.20.
<b>BCCH_CHANGE_MARK</b> (3 bit field) This field indicates the status of the information on BCCH. The value of this field shall be changed each time the information on BCCH, except for the contents of the SI13 message, is changed, see sub-clause 5.5.2.1.4.
<b>SI13_CHANGE_MARK</b> (2 bit field) This field is the binary representation of the SI change mark identifying the GPRS Mobile Allocation provided in SI13 and PSI13 messages. Range: 0 to 3.
<b>SI13 Mobile Allocation</b> This field is encoded using the <i>GPRS Mobile Allocation</i> information element defined in sub-clause 12.10a. This information shall be identical with the GPRS mobile allocation provided in SI13 and PSI13 messages.
<b>SPGC_CCCH_SUP</b> (1 bit field) This field is defined in the SI13 message, see 3GPP TS 44.018.
<b>PRIORITY_ACCESS_THR</b> (3 bit field) This field is defined in the SI13 message, see 3GPP TS 44.018.
<b>NETWORK_CONTROL_ORDER</b> (2 bit field) This field is defined in the SI13 message, see 3GPP TS 44.018.
<b>GPRS Cell Options</b> (information element) The <i>GPRS Cell Option</i> information element is defined in sub-clause 12.24.
<b>SGSNR</b> (1 bit field) This field is defined in the SI13 message, see 3GPP TS 44.018.
<b>GPRS Power Control Parameters</b> (information element) The <i>GPRS Power Control Parameters</i> information element is defined in sub-clause 12.9a.
<b>PSI1_REPEAT_PERIOD</b> (4 bit field) This field is the binary representation, range 0 to 15, of the PSI1 repeat period. The coding of this field is identical to the coding of the PSI1_REPEAT_PERIOD field in the PSI1 message.
<b>Pb</b> (4 bit field) This is the binary representation, range 0 to 15, of the power reduction value used by the BTS on PBCCH blocks and PCCCH blocks, relative to the output power on BCCH, see 3GPP TS 45.008.
<b>TN</b> (3 bit field) This is the binary representation, range 0 to 7, of the timeslot number for the PBCCH, see 3GPP TS 45.002.
<b>PBCCH Frequency Description</b> The PBCCH frequency description is encoded using the <i>Frequency Parameters</i> information element defined in sub-clause 12.8. When used in this message, the <i>Frequency Parameters</i> information element shall define a non-hopping radio frequency channel or use the <i>direct encoding 2</i> to define a hopping radio frequency channel.
<b>RAC</b> (8 bit field) This field is the binary representation of the Routing Area Code, see 3GPP TS 23.003.
<b>PSI_CHANGED_IND</b> (1 bit field) This field indicates whether the contents of any PSI message have been changed, see sub-clause 5.5.2.1.3. If not included in the message, the value "0" shall be assumed.
<b>SI_STATUS_IND</b> (1 bit field) 0 The network does not support the PACKET SI STATUS message; 1 The network supports the PACKET SI STATUS message. If not included in the message, the value "0" shall be assumed.

**LB\_MS\_TXPWR\_MAX\_CCH** (5 bit field)

The LB\_MS\_TXPWR\_MAX\_CCH field is coded as the binary representation of the 'power control level' in 3GPP TS 45.005 corresponding to the maximum TX power level a mobile station may use when accessing on a packet control channel. This value shall be used by the mobile station according to 3GPP TS 45.008.

**SI2n\_SUPPORT** (2 bit field)

This field indicates the support of SI2n in the network, see 3GPP TS 44.018.

## 11.2.25b Packet System Information 15

This message may be sent by the network on the PACCH. It may be sent to a mobile station with UTRAN capability. A mobile station with no UTRAN capability shall ignore this message.

The message provides the mobile station with a list of the UTRAN frequencies used by the network. These frequencies may be used in the cell selection procedure, see 3GPP TS 25.304. If both an UTRAN Frequency List Description struct and an UTRAN Frequency List information element (3GPP TS 44.018) are received, the mobile station shall use the one most recently received.

Message type: PACKET SYSTEM INFORMATION TYPE 15

Direction: network to mobile station

Classification: distribution message

**Table 11.2.25b.1: PSI15 information elements**

```

< PSI15 message content > ::=
  < PAGE_MODE : bit (2) >
  { 0 | 1 < UTRAN Frequency List : < UTRAN Frequency List Description struct >> }
  < padding bits >
  ! < Distribution part error : bit (*) = < no string >> ;

< UTRAN Frequency List Description struct > ::=
  { 1 < FDD_ARFCN > : bit (14) } ** 0      -- FDD frequencies
  { 1 < TDD_ARFCN > : bit (14) } ** 0 ;    -- TDD frequencies

```

**Table 11.2.25b.2: PSI15 information element details**

**PAGE\_MODE** (2 bit field)

This field is defined in sub-clause 12.20.

**UTRAN Frequency List Description struct**

FDD\_ARFCN and TDD\_ARFCN (14 bits field) are defined as the UARFCN in 3GPP TS 25.101 and 3GPP TS 25.102.

## 11.2.25c Packet System Information Type 16

This message is sent by the network on the PBCCH and the PACCH giving information about *Iu mode* operation. Special requirements for the transmission of this message apply on the PBCCH, see 3GPP TS 45.002.

This message shall not be segmented across more than one RLC/MAC control block by using the procedures specified in sub-clause 9.1.12a. A consistent set of this message type is required to completely decode the information (see sub-clause 5.5.2.1.4).

Message type: PACKET SYSTEM INFORMATION TYPE 16

Direction: network to mobile station

Classification: distribution message

**Table 11.2.25c.1: PSI16 information elements**

<pre> &lt; PSI16 message content &gt; ::=   &lt; PAGE_MODE : bit (2) &gt;   &lt; PSI16_CHANGE_MARK : bit (2) &gt;   &lt; PSI16_INDEX : bit (3) &gt;   &lt; PSI16_COUNT : bit (3) &gt;   &lt; GRA_ID_LIST : &lt; GRA ID struct &gt; &gt;   &lt; lu_MODE_NMO_SUPPORT : bit (1) &gt;   &lt; CN_DOMAIN_LIST : bit (2) &gt;   {     &lt; CN_DOMAIN_IDENTITY : &lt; CN Domain Identity IE &gt; &gt;     &lt; CN_DOMAIN_SPECIFIC_DRX_CYCLE_LENGTH_COEFFICIENT :       &lt; CN Domain Specific DRX Cycle Length Coefficient IE &gt; &gt;   } * (1+val(CN_DOMAIN_LIST))   { 0   1 &lt; 3G_LAC : bit (16) &gt; }   { 0   1 &lt; 3G_RAC : bit (8) &gt; }   { 0   1 &lt; GRA_AND_CELL_UPDATE_TIMER : bit (3) &gt; }   &lt; padding bits &gt;   ! &lt; Distribution part error : bit (*) = &lt; no string &gt;&gt; ;  &lt; GRA ID struct &gt; ::=   &lt; NUMBER_OF_GRA_IDs : bit (3) &gt;   { &lt; GRA_ID : bit (16) &gt; } * (1 + val(NUMBER_OF_GRA_IDs)); </pre>
---

**Table 11.2.25c.2: PSI16 information element details**

<p><b>PAGE_MODE</b> (2 bit field)</p> <p>This field describes which type of page mode used, i.e. either normal paging, extended paging, paging reorganization or same as before from the previous page mode. The mobile station shall ignore this field if the message is received on the PACCH. Coding of this field is defined in 3GPP TS 44.018</p>
<p><b>PSI16_CHANGE_MARK</b> (2 bit field)</p> <p>This field is the binary representation of the PSI <i>change mark</i> parameter identifying a consistent set of PSI16 messages. Range: 0 to 3.</p>
<p><b>PSI16_INDEX</b> (3 bit field)</p> <p>The PSI16 index field is used to distinguish individual PSI16 messages. The field can take the binary representation of the values 0 to n, where n is the index of the last PSI16 message. (PSI16 count). Range: 0 - 7.</p>
<p><b>PSI16_COUNT</b> (3 bit field)</p> <p>The PSI16 count field is coded as the binary representation of the last (highest indexed) individual PSI16 message. Range: 0 - 7.</p>
<p><i>GERAN Id struct</i></p> <p>At least one GRA Id shall be broadcast in each cell. Maximum number is eight.</p>
<p><b>NUMBER_OF_GRA_IDs</b> (3 bit field)</p> <p>The NUMBER of GRA Ids field is coded as the binary representation of the amount of GRA IDs sent in an individual PSI16 message. Range: 0 - 7.</p>
<p><b>GRA_ID</b> (16 bit field)</p> <p>The GRA_ID defines the indenty of a GERAN Registration Area Identity to which the cell belongs.</p>

<p><b>Iu_MODE_NMO_SUPPORT</b> (1 bit field)</p> <p>This parameter is used for determining network mode of operation for the 3G SGSN and the 3G MSC. The mobile station may assume that the network has set this field equally in all instances of this message.</p> <p>Bit</p> <p>0 Network Mode Operation I</p> <p>1 Network Mode Operation II</p>
<p><b>CN_DOMAIN_LIST</b> (2 bit field)</p> <p>This field is used to repeat information for each CN domain. Range : 0 to MaxCNdomains-1, see 3GPP TS 44.118.</p>
<p><b>CN_DOMAIN_IDENTITY</b></p> <p>This IE is defined in 3GPP TS 44.118.</p>
<p><b>CN_DOMAIN_SPECIFIC_DRX_CYCLE_LENGTH_COEFFICIENT</b></p> <p>This IE is defined in 3GPP TS 44.118.</p>
<p><b>3G_LAC</b> (16 bit field)</p> <p>This field is only broadcast if the cell supports <i>Iu mode</i> and if 2G and 3G are using different location area codes. The coding of 3G_LAC is presented in 3GPP TS 23.003.</p>
<p><b>3G_RAC</b> (8 bit field)</p> <p>This field is only broadcast if the cell supports <i>Iu mode</i> and if 2G and 3G are using different routing area codes. The coding of 3G_RAC is presented in 3GPP TS 23.003.</p>
<p><b>GRA_AND_CELL_UPDATE_TIMER</b> (3 bit field)</p> <p>This field is the binary representation of GRA and CELL UPDATE TIMERS.</p> <p>bit</p> <p>3 2 1</p> <p>0 0 0 5 minutes</p> <p>0 0 1 10 minutes</p> <p>0 1 0 30 minutes (default value)</p> <p>0 1 1 60 minutes</p> <p>1 0 0 120 minutes</p> <p>1 0 1 360 minutes</p> <p>1 1 0 720 minutes</p> <p>1 1 1 Infinity (no update)</p>

### 11.2.26 Packet TBF Release

This message is sent on the PACCH by the network to the mobile station to initiate release of an uplink or downlink TBF.

Message type: PACKET TBF RELEASE

Direction: network to mobile station

Classification: non-distribution message

**Table 11.2.26.1: PACKET TBF RELEASE information elements**

<pre> &lt; Packet TBF Release message content &gt; ::= &lt; PAGE_MODE : bit (2) &gt; {   0 &lt; GLOBAL_TFI : Global TFI IE &gt;   {     &lt; UPLINK_RELEASE : bit (1) &gt;     &lt; DOWNLINK_RELEASE : bit (1) &gt;     &lt; TBF_RELEASE_CAUSE : bit (4) = { 0000   0010 } &gt;     &lt; padding bits &gt;     ! &lt; Non-distribution part error : bit (*) = &lt; no string &gt; &gt; }     ! &lt; Address information part error : bit (*) = &lt; no string &gt; &gt; }   }   ! &lt; Distribution part error : bit (*) = &lt; no string &gt; &gt; ; </pre>
--

**Table 11.2.26.2: PACKET TBF RELEASE information element details**

<p><b>PAGE_MODE</b> (2 bit field) This field is defined in sub-clause 12.20.</p>								
<p><b>Global TFI IE</b> This information element contains the TFI of the mobile station's which uplink and/or downlink TBF to be released. This field is defined in sub-clause 12.10.</p>								
<p><b>Uplink_Release</b> (1 bit field) <b>Downlink_Release</b> (1 bit field) These fields indicate which TBF shall be release, uplink or downlink. Both directions can be released at the same time.</p> <p>0 TBF shall not be released 1 TBF shall be released</p>								
<p><b>TBF_RELEASE_CAUSE</b> (4 bit field) This field indicates the reason for the release of the TBF. This field is encoded according to the following table:</p> <table> <tr> <td>bit</td> <td></td> </tr> <tr> <td>4 3 2 1</td> <td></td> </tr> <tr> <td>0 0 0 0</td> <td>Normal release</td> </tr> <tr> <td>0 0 1 0</td> <td>Abnormal release</td> </tr> </table> <p>All other values are reserved, the same behaviour in reception as if 'Abnormal release'.</p>	bit		4 3 2 1		0 0 0 0	Normal release	0 0 1 0	Abnormal release
bit								
4 3 2 1								
0 0 0 0	Normal release							
0 0 1 0	Abnormal release							

## 11.2.27 (void)

## 11.2.28 Packet Uplink Ack/Nack

This message is sent on the PACCH by the network to the mobile station indicate the status of the received RLC data blocks. This message may also update the timing advance and power control parameters.

Message type: PACKET UPLINK ACK/NACK

Direction: network to mobile station

Classification: non-distribution message

Table 11.2.28.1: PACKET UPLINK ACK/NACK information elements

```

< Packet Uplink Ack/Nack message content > ::=
  < PAGE MODE : bit (2) >
  {
    00 < UPLINK_TFI : bit (5) >
    {
      0 -- Message escape
      {
        < CHANNEL_CODING_COMMAND : bit (2) >
        < Ack/Nack Description : < Ack/Nack Description IE > >
        {
          0 | 1 < CONTENTION_RESOLUTION_TLLI : bit (32) > }
          {
            0 | 1 < Packet Timing Advance : < Packet Timing Advance IE > > }
            {
              0 | 1 < Power Control Parameters : < Power Control Parameters IE > > }
              {
                0 | 1 < Extension Bits : Extension Bits IE > } -- sub-clause 12.26
                0 -- The value '1' was allocated in an earlier version of the protocol and shall not be used.
              }
            {
              null | 0 bit** = < no string > -- Receiver backward compatible with earlier version
              | 1 -- Additions for R99
            }
            {
              0 | 1 < Packet Extended Timing Advance : bit (2) > }
            < TBF_EST : bit (1) >
            {
              null | 0 bit** = < no string > -- Receiver backward compatible with earlier version
              | 1 -- Additions for Rel-5
            }
            {
              0 | 1 < CONTENTION_RESOLUTION Identifier extension : bit (4) > }
            {
              0 | 1 < RB Id : bit (5) > }
            {
              null | 0 bit** = < no string > -- Receiver backward compatible with earlier version
              | 1 -- Additions for Rel-10
            }
            {
              0 | 1 -- DTR Information
                < CI_DTR : bit (1) >
                < TN_PDCH_pair_DTR : bit (3) >
                < DTR BIKs : bit (2) > }
            < padding bits > }
          }
        }
      }
    }
    ! < Non-distribution part error : bit (*) = < no string > >
  }
  | 1 -- Message escape bit used to define EGPRS message contents
  {
    00
    {
      < EGPRS Channel Coding Command : < EGPRS Modulation and Coding Scheme IE >>
      < RESEGMENT : bit (1) >
      < PRE_EMPTIVE_TRANSMISSION : bit (1) >
      < PRR RETRANSMISSION REQUEST : bit (1) >
      < ARAC RETRANSMISSION REQUEST : bit (1) >
      {
        0 | 1 < CONTENTION_RESOLUTION_TLLI : bit (32) > }
      < TBF_EST : bit (1) >
      {
        0 | 1 < Packet Timing Advance : < Packet Timing Advance IE > > }
        {
          0 | 1 < Packet Extended Timing Advance : bit (2) > }
        {
          0 | 1 < Power Control Parameters : < Power Control Parameters IE > > }
          {
            0 | 1 < Extension Bits : Extension Bits IE > } -- sub-clause 12.26
            {
              < EGPRS Ack/Nack Description : < EGPRS Ack/Nack Description IE > >
              0 -- The value '1' was allocated in an earlier version of the protocol and shall not be used.
            }
          } //
          {
            null | 0 bit** = < no string > -- Receiver backward compatible with earlier version
            | 1 -- Additions for Rel-5
          }
          {
            0 | 1 < CONTENTION_RESOLUTION Identifier extension : bit (4) > }
            {
              0 | 1 < RB Id : bit (5) > }
            {
              null | 0 bit** = < no string > -- Receiver backward compatible with earlier version
              | 1 -- Additions for Rel-12
            }
            < PDAN Coding : bit (1) >
            {
              0 | 1
                < TN_PDCH_pair_DTR : bit (3) >
                < DTR BIKs : bit (2) > }
            < padding bits > } }
          ! < Non-distribution part error : bit (*) = < no string > > }
          ! < Message escape : { 01 | 10 | 11 } bit (*) = < no string > > } } -- Extended for future changes
          ! < Address information part error : bit (*) = < no string > > }
        ! < Distribution part error : bit (*) = < no string > > ;
      }
    }
  }

```



**Table 11.2.28.2: PACKET UPLINK ACK/NACK information element details**

<p><b>PAGE_MODE</b> (2 bit field) This field is defined in sub-clause 12.20.</p>										
<p><b>UPLINK_TFI</b> (5 bit field) This field identifies the uplink TBF to which this message applies. This field is coded the same as the TFI field defined in sub-clause 12.15. On DBPSCH, this field equals the radio bearer identity of the radio bearer to which this message applies.</p>										
<p><b>CHANNEL_CODING_COMMAND</b> (2 bit field) The Channel Coding Indicator field indicates the channel coding scheme that the mobile station shall use when transmitting on the uplink.</p> <p>bits</p> <table> <tr> <td>2 1</td> <td>value</td> </tr> <tr> <td>0 0</td> <td>CS-1</td> </tr> <tr> <td>0 1</td> <td>CS-2</td> </tr> <tr> <td>1 0</td> <td>CS-3</td> </tr> <tr> <td>1 1</td> <td>CS-4</td> </tr> </table>	2 1	value	0 0	CS-1	0 1	CS-2	1 0	CS-3	1 1	CS-4
2 1	value									
0 0	CS-1									
0 1	CS-2									
1 0	CS-3									
1 1	CS-4									
<p><b>Ack/Nack Description</b> This information element is defined in sub-clause 12.3.</p>										
<p><b>EGPRS Modulation and Coding Scheme</b> The EGPRS Modulation and Coding Scheme information element is defined in sub-clause 12.10d.</p>										
<p><b>RESEGMENT</b> (1 bit field) This field is defined in sub-clause 12.10e.</p>										
<p><b>PRE_EMPTIVE_TRANSMISSION</b> (1 bit field) This bit informs the mobile station if it may or may not transmit the oldest RLC data block whose corresponding element in V(B) has the value PENDING_ACK (and repeating the process, refer to sub-clause 9.1.3.2) when the protocol is stalled or has no more RLC data blocks to transmit.</p> <p>0 The mobile station shall not use pre-emptive transmission. 1 The mobile station shall use pre-emptive transmission.</p>										
<p><b>PRR RETRANSMISSION REQUEST (1 bit field)</b> 0 indicates that retransmission of a PACKET RESOURCE REQUEST message is not requested 1 indicates that retransmission of a PACKET RESOURCE REQUEST message is requested (see sub-clause 7.1.2.2.1a)</p>										
<p><b>ARAC RETRANSMISSION REQUEST (1 bit field)</b> 0 indicates that retransmission of an ADDITIONAL MS RADIO ACCESS CAPABILITIES message is not requested 1 indicates that retransmission of an ADDITIONAL MS RADIO ACCESS CAPABILITIES message is requested (see sub-clause 7.1.2.2.1a)</p>										
<p><b>EGPRS Ack/Nack Description</b> This information element is defined in sub-clause 12.3.1. The number of bits (L) available for Ack/Nack Description information element depends on the inclusion of other information elements. L may be set so that the entire PACKET UPLINK ACK/NACK message evenly fits into an RLC/MAC control block. If a lower L covers the entire receive window, that L may be used.</p>										
<p><b>CONTENTION_RESOLUTION_TLLI</b> (32 bit field) The CONTENTION_RESOLUTION_TLLI field is present only if the network has decoded one of the uplink RLC data blocks containing the TLLI or G-RNTI. The mobile station shall perform the contention resolution function if the TLLI or G-RNTI information element is present. This field contains a TLLI or a G-RNTI, which is defined in sub-clause 12.16.</p>										
<p><b>Packet Timing Advance</b> This information element is defined in sub-clause 12.12.</p>										

<p><b>Power Control Parameters</b> This information element, if present, contains the power control parameters the mobile station shall use to determine its TX power level. If this information element does not include the updated power control parameters for some of currently assigned timeslots, the MS shall continue to use the current power control parameters for these timeslots. This information element is defined in sub-clause 12.13.</p>
<p><b>Extension Bits</b> This information element, if present, shall be skipped over. Any information content shall be ignored by the mobile station. This information element is defined in sub-clause 12.26.</p>
<p><b>Packet Extended Timing Advance</b> (2 bit field) This field is defined in sub-clause 12.12b.</p>
<p><b>TBF_EST</b> (1 bit field) If included, this field indicates that the mobile station is allowed to request the establishment of new TBF on PACCH.</p> <p>0 the mobile station is not allowed to request the establishment of new TBF</p> <p>1 the mobile station is allowed to request the establishment of new TBF</p>
<p><b>CONTENTION_RESOLUTION Identifier extension</b> (4 bit field) This field contains the extra 4 bits of the G-RNTI not included in the CONTENTION_RESOLUTION_TLLI field which are necessary to provide a unique identifier for contention resolution in Iu-mode. This field is present when an assigned G-RNTI is used during the contention resolution procedure.</p>
<p><b>RB Id</b> (5 bit field) This field contains the radio bearer identity of the mobile station's radio bearer for which the uplink data transfer on SFACCH is acknowledged. This field is not included when the PACKET UPLINK ACK/NACK message is sent on DBPSCH. This field is encoded as a binary number with range 0-31.</p>
<p><b>CI_DTR</b> (1 bit field) This field indicates the carrier the mobile station shall monitor when DTR is used (see sub-clause 8.1.8). In case of single carrier configuration, this field shall be set to the value "0". The timeslot or PDCH-pair to monitor on this carrier is indicated with the TN_PDCH_pair_DTR field.</p> <p>0 carrier 1</p> <p>1 carrier 2. If received by a mobile station not supporting dual carrier it shall be interpreted as "0".</p>
<p><b>TN_PDCH_pair_DTR</b> (3 bit field) This field contains the timeslot number (BTTI configuration) or the PDCH-pair number (RTTI configuration) the mobile station shall monitor on the indicated carrier (CI_DTR field for a Downlink Dual Carrier configuration or the downlink carrier used for fall back according to a regular pre-determined interval (see sub-clause 8.1.8.2 and sub-clause 5.13) for a DLMC configuration) when DTR is used (see sub-clause 8.1.8).</p>
<p><b>DTR Blks</b> (2 bit field) This field indicates the subset of downlink radio blocks the mobile station shall monitor for USFs and/or downlink RLC data blocks in DTR mode. This field is coded as defined in sub-clause 10.4.26.</p>
<p><b>PDAN Coding</b> (1 bit field) See sub-clause 11.2.7.</p>

## 11.2.28a Packet DBPSCH Uplink Ack/Nack

This message is sent on FACCH, SACCH or SDCCH from the network to the mobile station to indicate the status of uplink RLC data blocks received.

Message type: PACKET DBPSCH UPLINK ACK/NACK

Direction: network to mobile station

Classification: DBPSCH message

Table 11.2.28a.1: PACKET DBPSCH UPLINK ACK/NACK information elements

<pre> &lt; Packet DBPSCH Uplink Ack/Nack message content &gt; ::= {   &lt; MESSAGE_TYPE : bit (6) == 001001 &gt;   &lt; RB Id : bit (5) &gt;   { 0   1 &lt; CONTENTION_RESOLUTION_TLLI : bit (32) &gt;     { 0   1 &lt; G-RNTI extension : bit (4) &gt; } }   { 0 -- TCH TBF mode     { 0 - All data blocks acknowledged, no retransmission requested         1 &lt; STARTING_SEQUENCE_NUMBER : bit (8) &gt;         &lt; RECEIVED_BLOCK_BITMAP : bit (128) &gt; }       1 -- DCCH TBF mode       { 0 - All data blocks acknowledged, no retransmission requested           1 &lt; STARTING_SEQUENCE_NUMBER : bit (4) &gt;           &lt; RECEIVED_BLOCK_BITMAP : bit (8) &gt; } }   &lt; padding bits &gt;   ! &lt; DBPSCH message part error : bit (*) = &lt; no string &gt; &gt; } ; </pre>
--

Table 11.2.28a.2: PACKET DBPSCH UPLINK ACK/NACK information element details

<p><b>CONTENTION_RESOLUTION_TLLI</b> (32 bit field)</p> <p>The CONTENTION_RESOLUTION_TLLI field is present only if the network has decoded one of the uplink RLC data blocks containing the G-RNTI. The mobile station shall perform the contention resolution function if the G-RNTI information element is present. This field contains a G-RNTI, which is defined in sub-clause 12.16.</p>
<p><b>G-RNTI extension</b> (4 bit field)</p> <p>This field contains the extra 4 bits of the G-RNTI not included in the CONTENTION_RESOLUTION_TLLI field which are necessary to provide a unique identifier for contention resolution in Iu-mode. This field is present when an assigned G-RNTI is used during the contention resolution procedure.</p>
<p><b>RB Id</b> (5 bit field)</p> <p>This field contains the radio bearer identity of the mobile station's radio bearer for which the uplink data transfer is acknowledged. This field is encoded as a binary number with range 0-31.</p>
<p><b>STARTING_SEQUENCE_NUMBER</b> (8 or 4 bit field)</p> <p>The SSN contains the value of V(R) when this information element was transmitted. This field is encoded as the binary representation of V(R).</p> <p>Range 0 to 255 (8 bit field)</p> <p>Range 0 to 15 (4 bit field)</p>

**RECEIVE\_BLOCK\_BITMAP (RBB)** (128 or 8 bit field)

The RBB is a bitmap representing Block Sequence Numbers. The bitmap is indexed relative to SSN as follows:

BSN = (SSN - bit\_number) modulo 256, for bit\_number = 1 to 128 (128 bit field).

BSN = (SSN - bit\_number) modulo 16, for bit\_number = 1 to 8 (8 bit field).

The BSN values represented range:

from (SSN - 1) mod 256 to (SSN - 128) mod 256 (128 bit field)

from (SSN - 1) mod 16 to (SSN - 8) mod 16 (8 bit field)

The value of each bit represents the acknowledgement status of the RLC data block with:

BSN = (SSN - bit\_number) mod 256 (128 bit field)

BSN = (SSN - bit\_number) mod 16 (8 bit field),

it is encoded as follows:

0 Negative acknowledgement

1 Positive acknowledgement

Mapping of the bitmap is defined in 3GPP TS 44.160.

## 11.2.28b Packet DBPSCH Uplink Ack/Nack Type 2

This message shall only be used when FLO is used. It is sent on ADCH from the network to the mobile station to indicate the status of uplink RLC data blocks received.

Message type: PACKET DBPSCH UPLINK ACK/NACK TYPE 2

Direction: network to mobile station

Classification: DBPSCH message

**Table 11.2.28b.1: PACKET DBPSCH UPLINK ACK/NACK TYPE 2 information elements**

```

< Packet DBPSCH Uplink Ack/Nack message content > ::=
{ < MESSAGE_TYPE : bit (6) == 001001 > -- The same message type as for Packet DBPSCH Uplink Ack/Nack is
  -- used since these two messages are mutually exclusive.
  < RB Id : bit (5) >
  { 0 -- UDCH TBF mode
    { 0 -- All data blocks acknowledged, no retransmission requested
      | < FLO Ack/Nack Description : < FLO Ack/Nack Description IE > > }
    | 1 -- CDCH TBF mode
      { 0 -- All data blocks acknowledged, no retransmission requested
        | < STARTING_SEQUENCE_NUMBER : bit (4) >
          < RECEIVED_BLOCK_BITMAP : bit (8) > } }
  < padding bits >
  ! < DBPSCH message part error : bit (*) = < no string > > ;

```

**Table 11.2.28b.2: PACKET DBPSCH UPLINK ACK/NACK TYP2 2 information element details**

**RB Id** (5 bit field)

This field contains the radio bearer identity of the mobile station's radio bearer for which the uplink data transfer is acknowledged. This field is encoded as a binary number with range 0-31.

**STARTING\_SEQUENCE\_NUMBER** (4 bit field)

The SSN contains the value of V(R) when this information element was transmitted. This field is encoded as the binary representation of V(R).

Range 0 to 15 (4 bit field)

**RECEIVE\_BLOCK\_BITMAP (RBB)** (128 or 8 bit field)

The RBB is a bitmap representing Block Sequence Numbers. The bitmap is indexed relative to SSN as follows:

$$\text{BSN} = (\text{SSN} - \text{bit\_number}) \text{ modulo } 16, \text{ for bit\_number} = 1 \text{ to } 8 \text{ (8 bit field).}$$

The BSN values represented range:

$$\text{from } (\text{SSN} - 1) \text{ mod } 16 \text{ to } (\text{SSN} - 8) \text{ mod } 16 \text{ (8 bit field)}$$

The value of each bit represents the acknowledgement status of the RLC data block with:

$$\text{BSN} = (\text{SSN} - \text{bit\_number}) \text{ mod } 16 \text{ (8 bit field),}$$

it is encoded as follows:

- 0 Negative acknowledgement
- 1 Positive acknowledgement

Mapping of the bitmap is defined in 3GPP TS 44.160.

## 11.2.29 Packet Uplink Assignment

This message is sent on the PCCCH or PACCH by the network to the mobile station to assign uplink resources. If the mobile station supports Downlink Dual Carrier or Downlink Multi Carrier, this message may be sent using extended RLC/MAC control message segmentation (see sub-clause 9.1.12a). The mobile station may be addressed by TFI, TQI, or Packet Request Reference depending upon the procedure used. A mobile allocation or reference frequency list received as part of this assignment message shall be valid until new assignment is received or each TBF of the MS are terminated.

Message type: PACKET UPLINK ASSIGNMENT

Direction: network to mobile station

Classification: non-distribution message

Table 11.2.29.1: PACKET UPLINK ASSIGNMENT information elements

```

< Packet Uplink Assignment message content > ::=
< PAGE_MODE : bit (2) >
{ 0 | 1 < PERSISTENCE_LEVEL : bit (4) > * 4 }
{
  { 0 < Global TFI : < Global TFI IE > >
  | 10 < TLLI / G-RNTI : bit (32) >
  | 110 < TQI : bit (16) >
  | 111 < Packet Request Reference : < Packet Request Reference IE > > }
  { 0 -- Message escape
  {
    < CHANNEL_CODING_COMMAND : bit (2) >
    < TLLI_BLOCK_CHANNEL_CODING : bit (1) >
    < Packet Timing Advance : < Packet Timing Advance IE > >
    { 0 | 1 < Frequency Parameters : < Frequency Parameters IE > > }
    { 01 < Dynamic Allocation : < Dynamic Allocation struct > >
    | 10 < Single Block Allocation : < Single Block Allocation struct > >
    | 00 < extension >
    } -- The value '11' was allocated in an earlier version of the protocol and shall not be used.
    { null | 0 bit** = < no string > -- Receiver backward compatible with earlier version
    | 1 -- Additions for R99
    { 0 | 1 < Packet Extended Timing Advance : bit (2) > }
    { null | 0 bit** = < no string > -- Receiver backward compatible with earlier version
    | 1 -- Additions for Rel-5
    { 0 | 1 < G-RNTI extension : bit (4) > }
    { 0 | 1 < RB Id : bit (5) > }
    { null | 0 bit** = < no string > -- Receiver backward compatible with earlier version
    | 1 -- Additions for Rel-6
    { 0 | 1 < PFI : bit (7) > }
    { 0 | 1 < RLC_MODE : bit (1) > }
    { null | 0 bit** = < no string > -- Receiver backward compatible with earlier version
    | 1 -- Additions for Rel-12
    < Primary TSC Set : bit (1) > < padding bits > } } } }
  ! < Non-distribution part error : bit (*) = < no string > > }

```

```

| 1      -- Message escape bit used to define EGPRS message contents
{ 00 { { 0 | 1 < CONTENTION_RESOLUTION_TLLI : bit(32) > }
      { 0 | 1 < COMPACT reduced MA : < COMPACT reduced MA IE >> }
      < EGPRS Channel Coding Command : < EGPRS Modulation and Coding Scheme IE >>
      < RESEGMENT : bit (1) >
      < EGPRS Window Size : < EGPRS Window Size IE >>
      { 0 | 1 < Access Technologies Request : Access Technologies Request struct > }
      < ARAC RETRANSMISSION REQUEST : bit (1) >
      < TLLI_BLOCK_CHANNEL_CODING : bit (1) >
      { 0 | 1 < BEP_PERIOD2 : bit (4) > }
      < Packet Timing Advance : < Packet Timing Advance IE >>
      { 0 | 1 < Packet Extended Timing Advance : bit (2) > }
      { 0 | 1 < Frequency Parameters : < Frequency Parameters IE >> }
      { 01 < Dynamic Allocation : < Dynamic Allocation struct >>
        | 10 < Multi Block Allocation : < Multi Block Allocation struct >>
        | 00 < extension >
      }
      -- The value '11' was allocated in an earlier version of the protocol and shall not be used.
      { null | 0 bit** = <no string> -- Receiver backward compatible with earlier version
      | 1 -- Additions for Rel-5
        { 0 | 1 < G-RNTI extension : bit (4) > }
        { 0 | 1 < RB Id : bit (5) > }
        { null | 0 bit** = <no string> -- Receiver backward compatible with earlier version
        | 1 -- Additions for Rel-6
          { 0 | 1 < PFI : bit (7) > }
          { 0 | 1 < RLC_MODE : bit (1) > }
          { null | 0 bit** = <no string> -- Receiver backward compatible with earlier version
          | 1 -- Additions for Rel-7
            { 0 | 1 < NPM Transfer Time : bit (5) > }
            { null | 0 bit** = <no string> -- Receiver backward compatible with earlier version
            | 1 -- Additions for Rel-9
              < Indication of Upper Layer PDU Start for RLC UM: bit >
              < Enhanced Flexible Timeslot Assignment : bit >
              { 0 < EMST_NW_Capability : bit (1) > -- EMST is not used
              | 1 < RLC Entity 2 : < RLC Entity Struct >> -- EMST is used
                { 0
                | 1 < RLC Entity 3 : < RLC Entity Struct >> }
              }
              { null | 0 bit** = <no string> -- Receiver backward compatible with earlier version
              | 1 -- Additions for Rel-10
                { 1 < EMSR Additional PFCs 1 : < Additional PFCs struct >> } ** 0
                { 1 < EMSR Additional PFCs 2 : < Additional PFCs struct >> } ** 0
                { 1 < EMSR Additional PFCs 3 : < Additional PFCs struct >> } ** 0
                { null | 0 bit** = <no string> -- Receiver backward compatible with earlier version
                | 1 -- Additions for Rel-12
                  < Primary TSC Set : bit (1) >
                }
              < padding bits > } } } } }
      ! < Non-distribution part error : bit (*) = <no string>> }
| 01      -- Message escape for dual carrier, RTTI, BTTI with FANR activated, EGPRS2
{ { 0 | 1 < CONTENTION_RESOLUTION_TLLI : bit(32) > }
  < RESEGMENT : bit (1) >
  < Assignment Info : Assignment Info struct >
  < EGPRS Window Size : < EGPRS Window Size IE >>
  { 0 | 1 < Access Technologies Request : Access Technologies Request struct > }
  < ARAC RETRANSMISSION REQUEST : bit (1) >
  < TLLI_BLOCK_CHANNEL_CODING : bit (1) >
  { 0 | 1 < BEP_PERIOD2 : bit (4) > }
  < Packet Timing Advance : < Packet Timing Advance IE >>
  { 0 | 1 < Packet Extended Timing Advance : bit (2) > }
  { 0 -- BTTI mode
  | 1 -- RTTI mode
    < RTTI_USF_MODE : bit (1) >
  }
  < PDCH Pairs Description : < PDCH Pairs Description IE >> }

```

```

< Dynamic Allocation 2: < Dynamic Allocation 2 struct > >
< EGPRS Channel Coding Command : < EGPRS Modulation and Coding Scheme IE >>
{ 00      -- No frequency parameters included
| 01      -- Legacy IEs used
  { 0 | 1 < Frequency Parameters C1 : < Frequency Parameters IE >> }
  { 0 | 1 < Frequency Parameters C2 : < Frequency Parameters IE >> }
| 10      -- Optimized Dual Carrier frequency parameters used
  < Dual Carrier Frequency Parameters : < Dual Carrier Frequency Parameters IE >>
  ! < Frequency Parameters error: { 11 } bit(*) = < no string > -- reserved for future used
}
{ 0 | 1 < PFI : bit (7) > }
{ 0 | 1 < RLC_MODE : bit (1) > }
{ 0 | 1 < NPM Transfer Time : bit (5) > }
{ 0 | 1 -- '1' indicates that FANR is activated
  { 0      -- SSN-based encoding is selected
  | 1      -- Time-based encoding is selected
    < REPORTED TIMESLOTS C1 : bit (8) >      -- carrier 1 in Downlink Dual Carrier
      --configuration
    { 0 | 1 < REPORTED TIMESLOTS C2 : bit (8) > } -- carrier 2 in Downlink Dual Carrier
      -- configuration
    < TSH : bit (2) > } }
< Uplink EGPRS Level: < EGPRS Level IE >>
{ 0 | 1 < Pulse Format: < Pulse Format IE >> }
{ null | 0 bit** = < no string > -- Receiver backward compatible with earlier version
| 1      -- Additions for Rel-9
  < Indication of Upper Layer PDU Start for RLC UM: bit >
  < Enhanced Flexible Timeslot Assignment : bit >
  { 0 < EMST_NW_Capability : bit (1) >      -- EMST is not used
  | 1 < RLC Entity 2 : < RLC Entity Struct >> -- EMST is used
    { 0
    | 1 < RLC Entity 3 : < RLC Entity Struct >> }
  }
  { 0 | 1 MTTI_UPLINK_ASSIGNMENT_C1 : bit (1) }
  { 0 | 1 MTTI_UPLINK_ASSIGNMENT_C2 : bit (1) }
  { null | 0 bit** = < no string > -- Receiver backward compatible with earlier version
  | 1      -- Additions for Rel-10
    { 1 < EMSR Additional PFCs 1 : < Additional PFCs struct >> } ** 0
    { 1 < EMSR Additional PFCs 2 : < Additional PFCs struct >> } ** 0
    { 1 < EMSR Additional PFCs 3 : < Additional PFCs struct >> } ** 0
    { null | 0 bit** = < no string > -- Receiver backward compatible with earlier version
    | 1      -- Additions for Rel-12
      < Primary TSC Set : bit (1) >
    }
  }
  < padding bits > } } }
! < Non-distribution part error : bit (*) = < no string >> }
| 10      -- Message escape for downlink multi carrier, RTTI, BTTI with FANR activated, EGPRS2
{
  < RESEGMENT : bit (1) >
  { 1 < < DLMC UL Carrier Info: < DLMC UL Carrier Info struct >> } ** 0
  < EGPRS Window Size : < EGPRS Window Size IE >>
  < UPLINK_TFI_ASSIGNMENT : bit (5) >
  < Packet Timing Advance : < Packet Timing Advance IE >>
  { 0 | 1 < Packet Extended Timing Advance : bit (2) > }
  { 0 | 1 < BEP_PERIOD2 : bit (4) > }
  { 0 | 1 < PFI : bit (7) > }
  { 0 | 1 < RLC_MODE : bit (1) > }
  { 0 | 1 < NPM Transfer Time : bit (5) > }
  { 0 | 1 -- '1' indicates that FANR is activated
    { 0      -- SSN-based encoding is selected
    | 1      -- Time-based encoding is selected
      < REPORTED TIMESLOTS : bit (8) >
      < TSH : bit (2) > } }
  < Uplink EGPRS Level: < EGPRS Level IE >>
  { 0 | 1 < Pulse Format: < Pulse Format IE >> }
  < Indication of Upper Layer PDU Start for RLC UM: bit >
  < Enhanced Flexible Timeslot Assignment : bit >
}

```



```

    < EGPRS Channel Coding Command : < EGPRS Modulation and Coding Scheme IE >>
    < padding bits > // -- truncation at end of message allowed, bits '0' assumed
    ! < Non-distribution part error : bit (*) = < no string > > }
    ! < Message escape : { 11 } bit (*) = < no string > > } - Extended for future changes
    ! < Address information part error : bit (*) = < no string > > }
    ! < Distribution part error : bit (*) = < no string > > ;

```

```

<extension> ::= -- Future extension can be done by modifying this structure

```

```

    null ;

```

```

<Dynamic Allocation struct > ::=

```

```

    < EXTENDED_DYNAMIC_ALLOCATION : bit (1) >

```

```

    { 0 | 1 < P0 : bit (4) >

```

```

        < PR_MODE : bit (1) > }

```

```

    < USF_GRANULARITY : bit (1) >

```

```

    { 0 | 1 < UPLINK_TFI_ASSIGNMENT : bit (5) > }

```

```

    0

```

```

        -- The value '1' was allocated in an earlier version of the protocol and shall not be used.

```

```

    { 0 | 1 < TBF Starting Time : < Starting Frame Number Description IE > > }

```

```

    { 0

```

```

        -- Timeslot Allocation

```

```

        { 0 | 1 < USF_TN0 : bit (3) > }

```

```

        { 0 | 1 < USF_TN1 : bit (3) > }

```

```

        { 0 | 1 < USF_TN2 : bit (3) > }

```

```

        { 0 | 1 < USF_TN3 : bit (3) > }

```

```

        { 0 | 1 < USF_TN4 : bit (3) > }

```

```

        { 0 | 1 < USF_TN5 : bit (3) > }

```

```

        { 0 | 1 < USF_TN6 : bit (3) > }

```

```

        { 0 | 1 < USF_TN7 : bit (3) > }

```

```

    | 1

```

```

        -- Timeslot Allocation with Power Control Parameters

```

```

        < ALPHA : bit (4) >

```

```

        { 0 | 1 < USF_TN0 : bit (3) >

```

```

            < GAMMA_TN0 : bit (5) > }

```

```

        { 0 | 1 < USF_TN1 : bit (3) >

```

```

            < GAMMA_TN1 : bit (5) > }

```

```

        { 0 | 1 < USF_TN2 : bit (3) >

```

```

            < GAMMA_TN2 : bit (5) > }

```

```

        { 0 | 1 < USF_TN3 : bit (3) >

```

```

            < GAMMA_TN3 : bit (5) > }

```

```

        { 0 | 1 < USF_TN4 : bit (3) >

```

```

            < GAMMA_TN4 : bit (5) > }

```

```

        { 0 | 1 < USF_TN5 : bit (3) >

```

```

            < GAMMA_TN5 : bit (5) > }

```

```

        { 0 | 1 < USF_TN6 : bit (3) >

```

```

            < GAMMA_TN6 : bit (5) > }

```

```

        { 0 | 1 < USF_TN7 : bit (3) >

```

```

            < GAMMA_TN7 : bit (5) > } } ;

```

```

<Single Block Allocation struct > ::=

```

```

    < TIMESLOT_NUMBER : bit (3) >

```

```

    { 0 | 1 < ALPHA : bit (4) >

```

```

        < GAMMA_TN : bit (5) > }

```

```

    { 0 | 1 < P0 : bit (4) >

```

```

    0

```

```

        -- The value '1' was allocated in an earlier version of the protocol and shall not be used.

```

```

        < PR_MODE : bit (1) > }

```

```

    < TBF Starting Time : < Starting Frame Number Description IE > > ;

```

```

< Multi Block Allocation struct > ::=

```

```

    < TIMESLOT_NUMBER : bit (3) >

```

```

    { 0 | 1 < ALPHA : bit (4) >

```

```

        < GAMMA_TN : bit (5) > }

```

```

    { 0 | 1 < P0 : bit (4) >

```

```

    0

```

```

        -- The value '1' was allocated in an earlier version of the protocol and shall not be used.

```

```

        < PR_MODE : bit (1) > }

```

```

    < TBF Starting Time : < Starting Frame Number Description IE > >

```

```

    < NUMBER OF RADIO BLOCKS ALLOCATED : bit (2) > ;

```

```

< Access Technologies Request struct > ::= -- recursive structure allows any combination of Access technologies

```

```

    < Access Technology Type : bit (4) >

```

```

    { 0 | 1 < Access Technologies Request struct > } ;

```

```

< Assignment Info struct > ::=
  < ASSIGNMENT TYPE : bit (2) >
  < Carrier ID : bit (1) >;

< Dynamic Allocation 2 struct > ::=
  < EXTENDED_DYNAMIC_ALLOCATION : bit (1) >
  { 0 | 1 < P0_C1 : bit (4) >
    < PR_MODE_C1 : bit (1) >
    { 0 | 1 < P0_C2 : bit (4) >
      < PR_MODE_C2 : bit (1) > } }
  < USF_GRANULARITY : bit (1) >
  { 0 | 1 < UPLINK_TFI_ASSIGNMENT : bit (5) > }
  { 0
    -- Allocation without Power Control Parameters
    < N_USF : bit (4) >
    { 0 | 1 < USF : bit (3) > } * ( val(N_USF) + 1)
  | 1
    -- Allocation with Power Control Parameters
    < ALPHA_C1 : bit (4) >
    { 0 | 1 < ALPHA_C2 : bit (4) > }
    { 0
      -- BTTI mode
      < N_TS : bit (4) >
      { 0 | 1
        < USF : bit (3) >
        < GAMMA : bit (5) >
      } * ( val(N_TS) + 1)
    | 1
      -- RTTI mode
      < N_PAIRS : bit (3) >
      { 0 | 1
        < USF : bit (3) >
        < GAMMA : bit (5) >
      } * ( val(N_PAIRS) + 1)
      { 0
        -- RTTI USF
      | 1
        -- BTTI USF
        { 0 | 1
          < USF_2 : bit (3) >
          { 0 | 1 < GAMMA : bit (5) > }
        } * ( val(N_PAIRS) + 1)
      }
    }
  }
};

< RLC Entity Struct > ::=
  < UPLINK_TFI_ASSIGNMENT : bit (5) >
  < RLC_MODE : bit (1) >
  { 0 | 1 < EGPRS Window Size : < EGPRS Window Size IE > > }
  < PFI : bit (7) >;

```

```

< Additional PFCs struct > ::=
  < UPLINK_TFI_ASSIGNMENT : bit (5) >
  { 0 | 1 < NPM Transfer Time : bit (5) > }
  < PFI : bit (7) >;
< DLMC UL Carrier Info struct > ::=
  { 00          -- Assigned carrier released
  | 01          -- Carrier remains unchanged (no information provided)
  | 10          -- Assigned carrier modified or new carrier assigned
    { 0          -- BTTI mode
      { 0 | 1 < UPLINK_TIMESLOT_ALLOCATION : bit (8) > } -- assigned PDCH
      | 1          -- RTTI mode
        { 0 | 1 < UPLINK_PDCH_PAIRS_DLMC : bit (8) > } -- assigned PDCH-pairs
    }
    < Dynamic Allocation 3 : < Dynamic Allocation 3 IE > >
    { 0 -- EMST is not used on this carrier
      | 1 -- EMST is used on this carrier
        < Uplink RLC Entity 2 : < RLC Entity Struct >
        { 0 | 1 < Uplink RLC Entity 3 : < RLC Entity Struct > } }
    { 0 -- EMSR is not used on this carrier
      | 1 -- EMSR is used on this carrier
        { 1 < EMSR Additional PFCs 1 : < Additional PFCs struct > > } ** 0
        { 1 < EMSR Additional PFCs 2 : < Additional PFCs struct > > } ** 0
        { 1 < EMSR Additional PFCs 3 : < Additional PFCs struct > > } ** 0
    }
    < Primary TSC Set : bit (1) >
  | 11 bit (*) = < no string > -- reserved
};

```

Table 11.2.29.2: PACKET UPLINK ASSIGNMENT information element details

<b>PAGE_MODE</b> (2 bit field) This field is defined in sub-clause 12.20.
<b>PERSISTENCE_LEVEL</b> (4 bit field for each Radio Priority 1...4) This field is defined in sub-clause 12.14, PRACH Control Parameters.
<b>Global TFI</b> This information element identifies the uplink TFI, if available, or the downlink TFI, to which this message applies. This field is defined in sub-clause 12.10.
<b>TLLI / G-RNTI</b> This information element is defined in sub-clause 12.16.
<b>TQI</b> (16 bit field) This field is defined in sub-clause 12.17.
<b>Packet Request Reference</b> This information element is defined in sub-clause 12.11.
<b>CHANNEL_CODING_COMMAND</b> (2 bit field) The Channel Coding Indicator field indicates the channel coding scheme that the mobile station shall use when transmitting data on the uplink.
<pre> bit 2 1 0 0    CS-1 0 1    CS-2 1 0    CS-3 1 1    CS-4 </pre>

<p><b>CONTENTION_RESOLUTION_TLLI</b> (32 bit field)  The CONTENTION_RESOLUTION_TLLI field is present only if the network has decoded one of the uplink blocks containing the TLLI or G-RNTI during the EGPRS one phase access. The mobile station shall perform the contention resolution function if this field is present. This field contains a TLLI or G-RNTI, which is defined in sub-clause 12.16. See sub-clause 7.1.2.3a.</p>
<p><b>COMPACT reduced MA</b>  This information element is defined in sub-clause 12.29.</p>
<p><b>EGPRS Modulation and Coding Scheme</b>  The EGPRS Modulation and Coding Scheme information element is defined in sub-clause 12.10d.</p> <p>If this field is included in a Dual Carrier assignment, it shall specify the initial EGPRS Modulation and Coding Scheme to be used on both carriers.</p>
<p><b>RESEGMENT</b> (1 bit field)  This field is defined in sub-clause 12.10e.</p>
<p><b>EGPRS Window Size</b>  This information element is defined in sub-clause 12.5.2.</p>
<p><b>TLLI_BLOCK_CHANNEL_CODING</b> (1 bit field)  This field indicates the channel coding command that the mobile station shall use for any RLC data block containing a TLLI field in the RLC data block header. This field is coded as shown:</p> <p>0 the mobile station shall use CS-1 in GPRS TBF mode and MCS-1 in EGPRS TBF mode.  1 the mobile station shall use the value commanded in the CHANNEL_CODING_COMMAND or EGPRS_CHANNEL_CODING_COMMAND field.</p>
<p><b>BEP_PERIOD2</b> (4 bit field)  This field contains a constant which is used for filtering channel quality measurements in EGPRS. BEP_PERIOD2 when present, or if not, when received in a previous message of the same TBF session, shall be used instead of BEP_PERIOD. For details see 3GPP TS 45.008.  Range: 0 to 15</p>
<p><b>UPLINK_TFI_ASSIGNMENT</b> (5 bit field)  This information element, if present, assigns the contained TFI to the mobile station to identify the uplink TBF described by this message. This field is coded the same as the TFI field defined in sub-clause 12.15. If EMST is used, each TFI identifies an RLC entity allocated on the uplink TBF. If EMSR is supported, each TFI identifies a Packet Flow Context supported by a specific RLC entity allocated on the uplink TBF.</p>
<p><b>Packet Timing Advance</b>  This information element is defined in sub-clause 12.12.</p>
<p><b>Frequency Parameters</b>  This information element, if present, assigns frequency parameters to the uplink TBF. If this information element is not present the mobile station shall use its previously assigned frequency parameters. This information element is defined in sub-clause 12.8.</p> <p><b>Frequency Parameters C1, Frequency Parameters C2</b>  These information elements are coded as defined in sub-clause 12.8. See sub-clause 11.2.7 for the usage of these information elements.</p> <p><b>Dual Carrier Frequency Parameters</b>  This information element, if present, assigns frequency parameters to the uplink TBF for both carriers in a dual carrier configuration. This information element is defined in sub-clause 12.8.2.</p>

**Dynamic Allocation struct**

This information element contains parameters necessary to define the radio resources of a dynamic allocation or an extended dynamic allocation.

In case of a timeslot allocation without power control parameters, the values of the power control parameters for assigned timeslots shall be the default values as specified in 3GPP TS 45.008. However, in case some of the timeslots assigned by this message are already used by the mobile station, the mobile station shall continue to use the current power control parameters for these timeslots.

**Dynamic Allocation 2 struct**

This information element contains parameters necessary to define the radio resources of a dynamic allocation or an extended dynamic allocation in a dual carrier, RTTI, BTTI with FANR activated, or EGPRS2 configuration.

In case of a timeslot allocation without power control parameters, the values of the power control parameters for assigned timeslots shall be the default values as specified in 3GPP TS 45.008. However, in case some of the timeslots assigned by this message are already used by the mobile station, the mobile station shall continue to use the current power control parameters for these timeslots.

**EXTENDED\_DYNAMIC\_ALLOCATION** (1 bit field)

This information field indicates the medium access mode to be used during the TBF.

- 0 Dynamic Allocation
- 1 Extended Dynamic Allocation

**TBF Starting Time**

The TBF Starting Time field contains a starting time that indicates the frame number during which the assigned TBF may start.

In case of dynamic allocation, if no uplink TBF is in progress, the MS need not monitor the USF field until the TDMA frame number occurs. When the indicated TDMA frame number occurs, the mobile station shall immediately begin to monitor the USF field and use the new assigned uplink TBF parameters when its USF has occurred. If an uplink TBF is already in progress, the MS shall continue to use the parameters of the existing TBF until the TDMA frame number occurs. When the indicated TDMA frame number occurs, the mobile station shall immediately begin to monitor the USF field and use the new assigned uplink TBF parameters when its USF has occurred.

In case of single block allocation, the mobile station shall use the assigned timeslot during the RLC/MAC block whose first TDMA burst occurs in the indicated TDMA frame number.

This information element is encoded as the Starting Frame Number Description IE. See sub-clause 12.21.

**USF\_TN0** (3 bit field)**USF\_TN1** (3 bit field)**USF\_TN2** (3 bit field)**USF\_TN3** (3 bit field)**USF\_TN4** (3 bit field)**USF\_TN5** (3 bit field)**USF\_TN6** (3 bit field)**USF\_TN7** (3 bit field)

These fields indicate the USF value assigned to the MS for assigned timeslots (range 0 to 7). These fields are encoded as a binary presentation of the USF value as defined in sub-clause 10.4.1.

**USF\_GRANULARITY** (1 bit field)

This information field indicates the USF granularity to be applied by the mobile station when it is assigned a TBF using Dynamic Allocation or Extended Dynamic Allocation.

- 0 the mobile station shall transmit one RLC/MAC block
- 1 the mobile station shall transmit four consecutive RLC/MAC blocks

**Single Block Allocation struct**

This information element contains parameters necessary to define the radio resources of a Single Block allocation. For example for sending of a PACKET RESOURCE REQUEST message in a two phase access or a Measurement report.

<p><b>TIMESLOT_NUMBER</b> (3 bit field)</p> <p>This field indicates the timeslot assigned for transfer of a single RLC/MAC block on the uplink. This field is coded as the binary representation of the timeslot number as defined in 3GPP TS 45.010. Range 0 to 7</p>
<p><b>ALPHA</b> (4 bit field)</p> <p>For encoding and description see the Global Power Control Parameters IE.</p> <p><b>ALPHA_C1, ALPHA_C2</b> (4 bit field)</p> <p>If the Assignment Type field is included and indicates 'Assignment on single carrier only' or 'Modification of existing assignment', then ALPHA_C1 (if present) shall apply to the carrier specified in the Carrier ID field.</p> <p>If the Assignment Type field is included and indicates 'Dual Carrier assignment', ALPHA_C1 and ALPHA_C2 indicate the value of the parameter alpha to be applied in power control on carrier 1 and carrier 2 respectively. For encoding and description see the Global Power Control Parameters IE. If ALPHA_C1 is present and ALPHA_C2 is absent, then ALPHA_C1 shall apply to carrier 2.</p>
<p><b>GAMMA, GAMMA_TN</b> (5 bit field)</p> <p>This field is the binary representation of the parameter <math>\Gamma_{CH}</math> for MS output power control in units of 2 dB, see 3GPP TS 45.008. The field is coded according to the following table:</p> <pre> bit 5 4 3 2 1 0 0 0 0    <math>\Gamma_{CH} = 0</math> dB 0 0 0 1    <math>\Gamma_{CH} = 2</math> dB ::: 1 1 1 1 0  <math>\Gamma_{CH} = 60</math> dB 1 1 1 1 1  <math>\Gamma_{CH} = 62</math> dB </pre> <p>In the case of RTTI mode with BTTI USF, exactly one GAMMA field shall be included for each PDCH pair for which either one or two USF values are assigned.</p>
<p><b>P0, P0_C1, P0_C2</b> (4 bit field)</p> <p>These fields are optional downlink power control parameters.</p> <p>If the Assignment Type field is present and indicates 'Dual Carrier assignment', P0_C1 and P0_C2 apply to carrier 1 and carrier 2, respectively. The presence of these parameters indicates that downlink power control is used for the indicated carrier; otherwise, downlink power control is not used for the indicated carrier. If the P0_C1 IE is present but the P0_C2 IE is absent, then the P0_C1 IE shall apply also to carrier 2.</p> <p>If the Assignment Type field is included and indicates 'Assignment on single carrier only' or 'Modification of existing assignment', then P0_C1 shall apply to the carrier specified in the Carrier ID field.</p> <p>These fields are encoded as follows:</p> <pre> bit 4 3 2 1 0 0 0 0    P0 = 0 dB 0 0 0 1    P0 = 2 dB 0 0 1 0    P0 = 4 dB : 1 1 1 1    P0 = 30 dB </pre>
<p><b>PR_MODE, PR_MODE_C1, PR_MODE_C2</b> (1 bit field)</p> <p>These fields indicate the PR Management mode, as defined in 3GPP TS 45.008.</p> <p>If the Assignment Type field is included and indicates 'Assignment on single carrier only' or 'Modification of existing assignment', then PR_MODE_C1 shall apply to the carrier specified in the Carrier ID field. Otherwise, PR_MODE_C1 and PR_MODE_C2 shall apply to carrier 1 and carrier 2 respectively. If the Assignment Type field indicates 'Dual Carrier assignment' and the PR_MODE_C1 IE is present but the PR_MODE_C2 IE is absent, then the PR_MODE_C1 IE shall apply also to carrier 2. It is encoded as follows:</p> <pre> 0 PR mode A: for one addressed MS 1 PR mode B: for all MS </pre>

<p><b>Packet Extended Timing Advance</b> (2 bit field) This field is defined in sub-clause 12.12b.</p>
<p><b>Multi Block Allocation struct</b> This information element contains parameters necessary to define the radio resources of a Multi Block allocation.</p>
<p><b>NUMBER OF RADIO BLOCKS ALLOCATED</b> (2 bit field) Bits 1 0 0 0      1 radio block reserved for uplink transmission 0 1      2 radio blocks reserved for uplink transmission 1 0      reserved for future use 1 1      reserved for future use</p>
<p><b>ACCESS TECHNOLOGY TYPE</b>  This field indicates the access technology that is requested from the mobile station. The field is coded according to the definition in 3GPP TS 24.008. The access technology types requested from the MS in the Access Technologies Request structure shall be classified by priority, the most important first. The MS shall reply using the same order. Among the three GSM 900 access technology types GSM P, GSM E and GSM R only one shall be requested by the network.</p>
<p><b>ARAC RETRANSMISSION REQUEST</b> (1 bit field) 0 indicates that retransmission of an ADDITIONAL MS RADIO ACCESS CAPABILITIES message is not requested 1 indicates that retransmission of an ADDITIONAL MS RADIO ACCESS CAPABILITIES message is requested (see sub-clause 7.1.2.2.1a)</p>
<p><b>G-RNTI extension</b> (4 bit field)  This field contains the extra 4 bits of the G-RNTI not included in the TLLI / G-RNTI field which are necessary to provide a unique identifier for contention resolution in Iu-mode. This field may also be included when an assigned G-RNTI is used in the CONTENTION_RESOLUTION_TLLI field during the contention resolution procedure.</p>
<p><b>RB Id</b> (5 bit field)  This field is included in Iu mode when a TBF is assigned in MAC-Shared state. It contains the radio bearer identifier for the radio bearer using the assigned TBF.</p>
<p><b>PFI</b> (7 bit field) This field contains the PFI parameter identifying the Packet Flow Context related to the TBF identified in the UPLINK_TFI_ASSIGNMENT field. The PFI parameter is encoded as the contents of the PFI information element defined in 3GPP TS 44.018. If EMST is used, this field contains the PFI parameter identifying the Packet Flow Context related to the RLC entity. If EMSR is supported, this field contains the PFI parameter identifying a Packet Flow Context supported by a specific RLC entity.</p> <p><b>RLC_MODE</b> (1 bit field) This field contains the RLC mode to be used for the assigned TBF.</p> <p>0 RLC acknowledged mode</p> <p>1 RLC unacknowledged mode. For the case of an EGPRS TBF an MS that supports RLC non-persistent mode shall respond to this indication of RLC mode as described in the EGPRS Window Size IE (see sub-clause 12.5.2).</p>
<p><b>NPM Transfer Time</b> (5 bit field) This field contains the NPM Transfer Time limitation for TBF or RLC entity assigned to operate in RLC non-persistent mode. If EMSR is supported this field contains the NPM Transfer Time limitation for a specific Packet Flow Context configured to use RLC non-persistent mode.</p>
<p><b>ASSIGNMENT TYPE</b> (2 bit field)  This indicates the type of assignment. The coding of this field is as specified in sub-clause 11.2.7.</p>

<p><b>Carrier ID</b> (1 bit field) This identifies the carrier to which the description refers.</p> <p>0 Carrier 1 1 Carrier 2</p>
<p><b>REPORTED TIMESLOTS</b> (8 bit field) The field indicates the timeslots for which feedback is provided by a time-based encoded PAN field and is encoded as the TIMESLOT_ALLOCATION IE defined in sub-clause 12.18.</p>
<p><b>PDCH Pairs Description</b> This information element is defined in sub-clause 12.5.5.</p>
<p><b>RTTI_USF_MODE</b> (1 bit field) This field identifies whether RTTI or BTTI USF Mode is enabled for this uplink RTTI TBF.</p> <p>0 BTTI USF Mode is enabled 1 RTTI USF Mode is enabled</p>
<p><b>TSH</b> (2 bit field)</p> <p>This field indicates the time-shift between the most recent radio block period for which feedback information is provided and the radio block period when the bitmap is sent:</p> <p>bit 2 1</p> <p>0 0 4 TDMA frames (for a basic TTI configuration) or 2 TDMA frames (for a reduced TTI or MTTI configuration) 0 1 8 TDMA frames (for a basic TTI configuration) or 4 TDMA frames (for a reduced TTI or MTTI configuration) 1 0 12 TDMA frames (for a basic TTI configuration) or 6 TDMA frames (for a reduced TTI or MTTI configuration) 1 1 16 TDMA frames (for a basic TTI configuration) or 8 TDMA frames (for a reduced TTI or MTTI configuration)</p>
<p><b>Uplink EGPRS Level</b> (2 bit field) This field specifies the group of modulation and coding schemes applicable to the TBF. This information element is defined in sub-clause 12.10f.</p>
<p><b>Pulse Format</b> (N bit field) This information element, if assigned, specified on which radio frequency channel the mobile station shall transmit using the narrow-band pulse option. The information element is defined in sub-clause 12.8.3.</p>
<p><b>N_USF, N_TS</b> (4 bit field) <b>N_PAIRS</b> (3 bit field) These fields indicate the number USF allocations signalled. The number of USFs is given as the binary value of the corresponding field plus one.</p> <p>See Annex K for details of the coding of these fields.</p>
<p><b>USF, USF_2</b> (3 bit field) These fields indicate the USF values assigned to the MS for the assigned timeslot or PDCH pair.</p> <p>In the case of RTTI mode with BTTI USF, the USF value specified in the USF field (respectively USF_2 field) applies to the first two (respectively second two) TDMA frames of the following basic radio block period (see sub-clauses 8.1.1.1, 8.1.1.2.1).</p> <p>These fields are encoded as a binary representation of the USF value as defined in sub-clause 10.4.1.</p> <p>The order in which USF assignments are encoded and the meaning when the number of repetitions of the USF is lower than the maximum is described in Annex K.</p>
<p><b>Indication of Upper Layer PDU Start for RLC UM</b> (1 bit field) This field is defined in section 11.2.7.</p>
<p><b>Enhanced Flexible Timeslot Assignment</b> (1 bit field) This field indicates whether Enhanced Flexible Timeslot Assignment, EFTA, shall be used for the assigned uplink TBF. This field is coded as follows:</p> <p>0 Enhanced Flexible Timeslot Assignment, EFTA shall not be used for the assigned uplink TBF. 1 Enhanced Flexible Timeslot Assignment, EFTA shall be used for the assigned uplink TBF.</p>



<p><b>EMST_NW_Capability</b> (1 bit field) This information element indicates the network's support of EMST</p> <p>0 The network does not support EMST 1 The network supports EMST</p>
<p><b>MTTI_UPLINK_ASSIGNMENT_C1</b> (1 bit field) <b>MTTI_UPLINK_ASSIGNMENT_C2</b> (1 bit field)</p> <p>These fields indicate whether the assigned uplink TBF operates in MTTI configuration. If present, a PDCH is assigned on the respective carrier in addition to any assigned PDCH-pairs. If set to '1' (respectively '0'), the assigned PDCH uses the timeslot immediately adjacent to and lower than (respectively higher than) the lower (respectively higher) timeslot used by the lowest numbered (respectively highest numbered) PDCH-pair assigned on that carrier. If no PDCH-pairs are assigned on one carrier, then the assigned PDCH for that carrier is on the same timeslot as the assigned PDCH on the other carrier, regardless of the value of the field.</p>
<p><b>EMSR Additional PFCs 1</b> <b>EMSR Additional PFCs 2</b> <b>EMSR Additional PFCs 3</b></p> <p>These IEs are defined in section 11.2.7.</p>
<p><b>DLMC UL Carrier Info</b></p> <p>This information element is used to describe the uplink carriers applicable to an uplink TBF assigned for a DLMC configuration. It provides information for one or more of the uplink carriers corresponding to the downlink carriers (see sub-clause 8.1.1.2.1 and 8.1.2.5) where the uplink carriers are referenced in ascending order starting with the uplink carrier corresponding to downlink carrier C1, followed by the uplink carrier corresponding to downlink carrier C2 and so on (see sub-clause 8.1.1.1.3 for the numbering of downlink carriers in a DLMC configuration). The assignment message allows for releasing an existing carrier, keeping an existing carrier unchanged, modifying an existing carrier or adding a new carrier.</p>
<p><b>UPLINK_TIMESLOT_ALLOCATION</b> (8 bit field)</p> <p>This field is defined in sub-clause 12.18.</p>
<p><b>UPLINK_PDCH_PAIR_DLMC</b></p> <p>This field is defined in sub-clause 11.2.31</p>
<p><b>Dynamic Allocation 3</b></p> <p>This information element provides information for an uplink carrier corresponding to a downlink carrier assigned for a DLMC configuration. It shall always include information for the lowest numbered PDCH/PDCH-pair assigned on the referenced uplink carrier. If information is excluded for any additional PDCH/PDCH-pair assigned for the referenced uplink carrier then the MS shall apply the information provided for the lowest numbered PDCH/PDCH-pair assigned for that carrier. This information element is defined in sub-clause 12.65.</p>
<p><b>Primary TSC Set</b> (1 bit field)</p> <p>If a mobile station supports the extended TSC sets (see 3GPP TS 45.002 [32]) then it shall use this field to identify the TSC set associated with the TSC value indicated by the <i>Frequency Parameters</i> IE, <i>Dual Carrier Frequency Parameters</i> IE or <i>DLMC Frequency Parameters</i> IE for use on the assigned uplink PS resources. This field is coded as follows:</p> <p>0 TSC set 1 1 Indicates TSC set 2 for 8PSK, 16QAM and 32QAM modulation. For GMSK modulation it indicates TSC set 3 (which is identical to TSC set 3 used for the CS domain).</p>

### 11.2.29.1 Special requirements in dual transfer mode for uplink TBF

Special requirements apply when an uplink TBF is assigned to a mobile station in dual transfer mode or about to enter dual transfer mode.

If the mobile station has an RR connection to the network on a half-rate TCH, the network may assign an uplink TBF using the other sub-channel of the same timeslot for a half-rate PDCH (see 3GPP TS 45.002). In this case, the uplink assignment message shall be encoded with a timeslot allocation including the timeslot number for the half-rate TCH and the half-rate PDCH, and only that timeslot number. The mobile station shall interpret this allocation as an allocation of a half-rate PDCH.

In dual transfer mode, the mobile station may be assigned an uplink TBF using exclusive allocation. The exclusive allocation shall be applied according to the conditions specified in sub-clause 8.1.0. When the exclusive allocation is applied, the mobile station shall ignore the USF values assigned in the uplink assignment message.

### 11.2.29a Multiple TBF Uplink Assignment

This message is sent on the PACCH by the network to the mobile station to assign uplink resources. If the mobile station supports Downlink Dual Carrier, this message may be sent using extended RLC/MAC control message segmentation (see sub-clause 9.1.12a). The mobile station may be addressed by the G-RNTI or the TFI depending upon the procedure used. A mobile allocation or reference frequency list received as part of this assignment message shall be valid until new assignment is received or each TBF of the MS are terminated.

Message type: MULTIPLE TBF UPLINK ASSIGNMENT

Direction: network to mobile station

Classification : non-distribution message

Table 11.2.29a.1: MULTIPLE TBF UPLINK ASSIGNMENT information elements

```

< Multiple TBF Uplink Assignment message content > ::=
< PAGE_MODE : bit (2) >
{ 0 | 1 < PERSISTENCE_LEVEL : bit (4) > * 4 }
{
  { 0 < Global TFI : < Global TFI IE > >
    | 10 { < TLLI / G-RNTI : < TLLI / G-RNTI IE > > < G-RNTI extension : bit (4) > } }
  { 0 -- Message escape bit for GPRS mode TBFs
    { { 0 | 1 < CHANNEL_CODING_COMMAND : bit (2) > }
      < TLLI_BLOCK_CHANNEL_CODING : bit (1) >
      < Packet Timing Advance : < Packet Timing Advance IE > >
      { 0 | 1 < Packet Extended Timing Advance : bit (2) > }
      { 0 | 1 < Frequency Parameters : < Frequency Parameters IE > > }
      { 0 | 1 < Uplink TBF Assignment : < Uplink Assignment struct > > }
      < padding bits > }
    ! < Non-distribution part error : bit (*) = < no string > > }
  | 1 -- Message escape bit for EGPRS mode TBFs
    { 00
      {
        { 0 | 1 < EGPRS Window Size : < EGPRS Window Size IE > > }
        { 0 | 1 < EGPRS Channel Coding Command : < EGPRS Modulation and Coding Scheme IE > > }
        < Resegment : < RESEGMENT IE > >
        < TLLI_BLOCK_CHANNEL_CODING : bit (1) >
        { 0 | 1 < BEP_PERIOD2 : bit(4) > }
        < Packet Timing Advance : < Packet Timing Advance IE > >
        { 0 | 1 < Packet Extended Timing Advance : bit (2) > }
        { 0 | 1 < Frequency Parameters : < Frequency Parameters IE > > }
        { 0 | 1 < Uplink TBF Assignment : < Uplink Assignment struct > > }
        { null | 0 bit** = < no string > -- Receiver backward compatible with earlier version
          | 1 -- Additions for Rel-7
            { 0 | 1 < NPM Transfer Time : bit (5) > } ** 0
            { null | 0 bit** = < no string > -- Receiver backward compatible with earlier version
              | 1 -- Additions for Rel-9
                { 1 < Indication of Upper Layer PDU Start for RLC UM : bit > } ** 0
                < Enhanced Flexible Timeslot Assignment : bit >
                < padding bits > } } }
        ! < Non-distribution part error : bit (*) = < no string > > }
      | 01
        {
          { 0 | 1 < EGPRS Window Size : < EGPRS Window Size IE > > }
          { 0 | 1 < EGPRS Channel Coding Command : < EGPRS Modulation and Coding Scheme IE > > }
          < Assignment Info : < Assignment Info struct > >
          < RESEGMENT : bit (1) >
          < TLLI_BLOCK_CHANNEL_CODING : bit (1) >
          { 0 | 1 < BEP_PERIOD2 : bit (4) > }
          < Packet Timing Advance : < Packet Timing Advance IE > >
          { 0 | 1 < Packet Extended Timing Advance : bit (2) > }
          { 00 -- No frequency parameters included
            | 01 -- Legacy IEs used
              { 0 | 1 < Frequency Parameters C1 : < Frequency Parameters IE > > }
              { 0 | 1 < Frequency Parameters C2 : < Frequency Parameters IE > > }
            | 10 -- Optimized Dual Carrier frequency parameters used
              < Dual Carrier Frequency Parameters : < Dual Carrier Frequency Parameters IE > >
              ! < Frequency Parameters error: { 11 } bit(*) = < no string > > } -- reserved for future used
            { 0 | 1 < Uplink TBF Assignment 2 : < Uplink Assignment 2 struct > > }
            < Uplink EGPRS Level: < EGPRS Level IE > >
            { 0 | 1 < Pulse Format: < Pulse Format IE > > }
            { null | 0 bit** = < no string > -- Receiver backward compatible with earlier version
              | 1 -- Additions for Rel-9
                { 1 < Indication of Upper Layer PDU Start for RLC UM : bit > } ** 0
                < Enhanced Flexible Timeslot Assignment : bit >
                < padding bits > }
            ! < Non-distribution part error : bit (*) = < no string > > }
          ! < Message escape : { 10 | 11 } bit (*) = < no string > > } - Extended for future changes
        }
      ! < Address information part error : bit (*) = < no string > > }
    ! < Distribution part error : bit (*) = < no string > > ;

```

```

< Uplink Assignment struct > ::=
  < EXTENDED_DYNAMIC_ALLOCATION : bit (1) >
  { 0 | 1 < Uplink Control Timeslot : bit (3) > }
  { 0 | 1 < P0 : bit (4) >
    < PR_MODE : bit(1) > }
  { 0 | 1 < TBF Starting Time : < Starting Frame Number Description IE > > }
  { 0 | 1 < Global Timeslot description : < Timeslot description struct > >
    { 1 < Uplink TBF Assignment : < Uplink TBF Assignment struct > > } ** 0 } ;

< Uplink Assignment 2 struct > ::=
  < EXTENDED_DYNAMIC_ALLOCATION : bit (1) >
  { 0 | 1 < Uplink Control Timeslot C1 : bit (3) > }
  { 0 | 1 < Uplink Control Timeslot C2 : bit (3) > }
  { 0 | 1 < P0_C1 : bit (4) >
    < PR_MODE_C1 : bit(1) >
    { 0 | 1 < P0_C2 : bit (4) >
      < PR_MODE_C2 : bit(1) > } }
  { 0 | 1 -- '1' indicates that FANR is activated
    { 0 -- SSN-based encoding is selected
      | 1 -- Time-based encoding is selected
    < TSH : bit (2) > } }
  { 0 | 1
    { 0 | 1 -- BTTI mode
      < Global Timeslot description : < Timeslot description 2 struct > >
      { 1 < Uplink TBF Assignment 2: < Uplink TBF Assignment 2 IE > > } ** 0
    }
    { 0 | 1 -- RTTI mode
      < PDCH Pairs Description : < PDCH Pairs Description struct > >
      { 0 -- without power control parameters
        | 1 -- with power control parameters
          < ALPHA_C1 : bit (4) >
          { 0 | 1 < ALPHA_C2 : bit (4) > }
          < N_PAIRS : bit (3) >
          { 0 | 1 < GAMMA : bit (5) > } * (val(N_PAIRS) + 1)
          { 0 -- RTTI USF, or no second GAMMA values are given in case of RTTI mode with BTTI USF
            | 1 -- Second GAMMA values are given in case of RTTI mode with BTTI USF
              { 0 | 1 < GAMMA : bit (5) > } * (val(N_PAIRS) + 1)
            }
          }
        { 1 < Uplink TBF Assignment 2: < Uplink TBF Assignment 2 struct > >
          < RTTI_USF_MODE : bit (1) > } ** 0
        }
      }
    }
  } ;

< Timeslot description struct > ::=
  { 0 -- without power control params
    < MS_TIMESLOT_ALLOCATION : bit (8) >
  | 1 -- with power control params
    < ALPHA : bit (4) >
    { 0 | 1 < GAMMA_TN0 : bit (5) > }
    { 0 | 1 < GAMMA_TN1 : bit (5) > }
    { 0 | 1 < GAMMA_TN2 : bit (5) > }
    { 0 | 1 < GAMMA_TN3 : bit (5) > }
    { 0 | 1 < GAMMA_TN4 : bit (5) > }
    { 0 | 1 < GAMMA_TN5 : bit (5) > }
    { 0 | 1 < GAMMA_TN6 : bit (5) > }
    { 0 | 1 < GAMMA_TN7 : bit (5) > } } ;

```

```

< Timeslot description 2 struct > ::=
{
  0 -- without power control params
  < MS_TIMESLOT_ALLOCATION_C1 : bit (8) >
  { 0 | 1 < MS_TIMESLOT_ALLOCATION_C2 : bit (8) > }
  1 -- with power control params
  < ALPHA_C1 : bit (4) >
  { 0 | 1 < GAMMA_TN0_C1 : bit (5) > }
  { 0 | 1 < GAMMA_TN1_C1 : bit (5) > }
  { 0 | 1 < GAMMA_TN2_C1 : bit (5) > }
  { 0 | 1 < GAMMA_TN3_C1 : bit (5) > }
  { 0 | 1 < GAMMA_TN4_C1 : bit (5) > }
  { 0 | 1 < GAMMA_TN5_C1 : bit (5) > }
  { 0 | 1 < GAMMA_TN6_C1 : bit (5) > }
  { 0 | 1 < GAMMA_TN7_C1 : bit (5) > }
  { 0 | 1 < ALPHA_C2 : bit (4) > }
  { 0 | 1 < GAMMA_TN0_C2 : bit (5) > }
  { 0 | 1 < GAMMA_TN1_C2 : bit (5) > }
  { 0 | 1 < GAMMA_TN2_C2 : bit (5) > }
  { 0 | 1 < GAMMA_TN3_C2 : bit (5) > }
  { 0 | 1 < GAMMA_TN4_C2 : bit (5) > }
  { 0 | 1 < GAMMA_TN5_C2 : bit (5) > }
  { 0 | 1 < GAMMA_TN6_C2 : bit (5) > }
  { 0 | 1 < GAMMA_TN7_C2 : bit (5) > }
};

< Uplink TBF Assignment struct > ::= -- Recursive for multiple TBFs
{
  0 < RB Id : bit (5) >
  1 < PFI : bit (7) > }
  < RLC_MODE : bit (1) > }
  < TFI Assignment : bit (5) >
  { 0 | 1 < CHANNEL_CODING_COMMAND : bit (2) > }
  { 0 | 1 < EGPRS Channel Coding Command : < EGPRS Modulation and Coding Scheme IE > > }
  { 0 | 1 < EGPRS Window Size : < EGPRS Window Size IE > > }
  < USF GRANULARITY : bit (1) >
  0 -- The timeslots assigned to the TBF are all the timeslots assigned
  -- in the Global Timeslot description
  1 < TBF_TIMESLOT_ALLOCATION : bit (N) > } -- The timeslots assigned to the TBF are a subset of all the
  -- timeslots assigned in the Global Timeslot description. Where
  -- N is the amount of timeslots assigned to the MS in the Global
  -- Timeslot description
  0 < USF_ALLOCATION : bit (3) > -- The same USF is valid on all timeslots assigned to the TBF
  1 -- Different USF(s) assigned
  < USF_ALLOCATION : bit (3) > -- USF assignment on the lowest numbered timeslot
  -- assigned to the TBF
  { 0 | 1 < USF_ALLOCATION : bit (3) > } * (M-1) ; -- USFs on subsequent timeslots assigned to the TBF:
  -- A "0" (respectively a "1" followed by a USF value)
  -- means same (respectively different) USF value as the
  -- USF on the next lower numbered timeslot assigned to
  -- the TBF. Where M is the amount of timeslots assigned
  -- to the TBF in the TBF_TIMESLOT_ALLOCATION if
  -- present, else in the Global Timeslot description

```

```

< Uplink TBF Assignment 2 struct > ::=
  -- Recursive for multiple TBFs
  < PFI : bit (7) >
  < RLC_MODE : bit (1) >
  < TFI Assignment : bit (5) >
  { 0 | 1 < EGPRS Channel Coding Command: < EGPRS Modulation and Coding Scheme IE > > }
  { 0 | 1 < EGPRS Window Size : < EGPRS Window Size IE > > }
  < USF GRANULARITY : bit (1) >
  { 0 | 1 < NPM Transfer Time : bit (5) > }
  { 0 | 1 -- '1' indicates that time-based FANR is selected
    < REPORTED TIMESLOTS C1 : bit (8) > -- carrier 1 in Downlink Dual Carrier configuration
    { 0 | 1 < REPORTED TIMESLOTS C2 : bit (8) > } -- carrier 2 in Downlink Dual Carrier configuration
  }
  { 0 -- The timeslots/PDCH-pairs assigned to the TBF are all the timeslots assigned
    -- in the Global Timeslot description or PDCH pair description
  | 1 < TBF_TIMESLOT_ALLOCATION : bit (N) > } -- see description in Table 11.2.29a.2
  { 0 < USF_ALLOCATION_C1 : bit (3) >
    { 0 | 1 < USF_ALLOCATION_C2 : bit (3) > } -- The same USF is valid on all timeslots/PDCH-pairs assigned
    -- to the TBF for each specified carrier
  | 1 -- Different USF(s) assigned; see description in Table 11.2.29a.2
    < USF_ALLOCATION : bit (3) >
    { 0 | 1 < USF_ALLOCATION : bit (3) > } * (M-1)
  };
< Assignment Info struct > ::=
  < Assignment Type : bit (2) >
  < Carrier ID : bit (1) >;

```

Table 11.2.29a.2: MULTIPLE TBF UPLINK ASSIGNMENT information element details

<b>PAGE_MODE</b> (2 bit field) This field is defined in sub-clause 12.20.
<b>PERSISTENCE_LEVEL</b> (4 bit field for each Radio Priority 1...4) This field is defined in sub-clause 12.14, PRACH Control Parameters.
<b>TLLI / G-RNTI</b> This information element is defined in sub-clause 12.16.
<b>G-RNTI extension</b> (4 bit field)  This field contains the extra 4 bits of the G-RNTI not included in the TLLI / G-RNTI field or CONTENTION_RESOLUTION Identifier field which are necessary to provide a unique identifier for contention resolution in Iu-mode.
<b>Global TFI</b> This information element identifies one of the mobile station's downlink or uplink TFIs. This field is defined in sub-clause 12.10.
<b>CHANNEL_CODING_COMMAND</b> (2 bit field) The Channel Coding Indicator field indicates the channel coding scheme that the mobile station shall use when transmitting data on the uplink. If this field is included in the main body of the message, it shall refer to all GPRS TBF mode uplink TBFs assigned in the message (default value). If this field is included in the Uplink TBF Assignment struct, it refers only to the TBF given by the TFI Assignment (this specific value overrules the default value). Every TBF defined in GPRS TBF mode shall be assigned either the default value or a specific value.  Bit 2 1 0 0 CS-1 0 1 CS-2 1 0 CS-3 1 1 CS-4
<b>RESEGMENT</b> (1 bit field) This field is defined in sub-clause 12.10e.

<p><b>EGPRS Window Size</b> This information element is defined in sub-clause 12.5.2.</p> <p>If this field is included in the main body of the message, it shall refer to all EGPRS TBF mode uplink TBFs assigned in the message (default value). If this field is included in the Uplink TBF Assignment struct, it refers only to the TBF given by the TFI Assignment (this specific value overrides the default value). Every TBF defined in EGPRS TBF mode shall be assigned either the default value or a specific value.</p>
<p><b>EGPRS Modulation and Coding Scheme</b> This field contains the <i>EGPRS Modulation and Coding Scheme</i> information element defined in sub-clause 12.10d.</p> <p>If this field is included in the main body of the message, it shall refer to all EGPRS TBF mode uplink TBFs assigned in the message (default value). If this field is included in the Uplink TBF Assignment struct, it refers only to the TBF given by the TFI Assignment (this specific value overrides the default value). Every TBF defined in EGPRS TBF mode shall be assigned either the default value or a specific value.</p> <p>If this field is included in a Dual Carrier assignment, it shall specify the initial EGPRS Modulation and Coding Scheme to be used on both carriers.</p>
<p><b>TLLI_BLOCK_CHANNEL_CODING</b> (1 bit field) This field indicates the channel coding command that the mobile station shall use for any RLC data block containing a TLLI / G-RNTI field in the RLC data block header. This field is coded as shown:</p> <p>0 the mobile station shall use CS-1 in GPRS TBF mode and MCS-1 in EGPRS TBF mode. 1 the mobile station shall use the value commanded in the CHANNEL_CODING_COMMAND or EGPRS_CHANNEL_CODING_COMMAND field.</p>
<p><b>BEP_PERIOD2</b> (4 bit field) This field contains a constant which is used for filtering channel quality measurements in EGPRS. BEP_PERIOD2 when present, or if not, when received in a previous message of the same TBF session, shall be used instead of BEP_PERIOD. For details see 3GPP TS 45.008. Range: 0 to 15</p>
<p><b>TFI Assignment</b> (5 bit field) This information element assigns one TFI to each TBF assigned to the mobile station in this message. This field is repeated for each TBF that is assigned in this message. TFI values are encoded as defined in sub-clause 12.15.</p>
<p><b>RB Id</b> (5 bit field) This field contains the radio bearer identifier for the radio bearer using the assigned TBF. This provides the mapping of TFI to RB Id which is necessary to uniquely identify Iu-mode data flows.</p>
<p><b>PFI</b> (7 bit field) This field contains the PFI parameter identifying a Packet Flow Context. The PFI parameter is encoded as the contents of the PFI information element as defined in 3GPP TS 44.018.</p> <p><b>RLC_MODE</b> (1 bit field) This field contains the RLC mode to be used for the assigned TBF.</p> <p>0 RLC acknowledged mode 1 RLC unacknowledged mode. For the case of an EGPRS TBF an MS that supports RLC non-persistent mode shall respond to this indication of RLC mode as described in the EGPRS Window Size IE (see sub-clause 12.5.2).</p>

**Uplink Control Timeslot** (3 bit field)

In case of a BTTI configuration, this field contains the timeslot number of the timeslot where the PACCH for the MS is located. In case of an RTTI configuration, this field contains the timeslot number of the timeslot belonging to the uplink PDCH pair where the PACCH/U for the MS is located. It is encoded as the binary representation of the timeslot number as defined in 3GPP TS 45.002.

**Uplink Control Timeslot C1** (3 bit field)

In case of a BTTI configuration, this field contains the timeslot number of the timeslot where the PACCH for the MS is located. In case of an RTTI configuration, this field contains the timeslot number of the timeslot belonging to the uplink PDCH pair where the PACCH/U for the MS is located. It is encoded as the binary representation of the timeslot number as defined in 3GPP TS 45.002. If the Assignment Type field is present and indicates 'Dual Carrier assignment', this field applies to carrier 1, otherwise this field applies to the carrier identified by the Carrier ID field.

**Uplink Control Timeslot C2** (3 bit field)

If the Assignment Type field is present and indicates 'Dual Carrier assignment', this field contains the timeslot number on carrier 2 of the timeslot where the PACCH for the MS is located in case of a BTTI configuration, or the timeslot number of the timeslot belonging to the uplink PDCH pair where the PACCH/U for the MS is located in case of an RTTI configuration. It is encoded as the binary representation of the timeslot number as defined in 3GPP TS 45.002.

**Packet Timing Advance**

This information element is defined in sub-clause 12.12.

**Frequency Parameters**

This information element, if present, assigns frequency parameters to the uplink TBF. If this information element is not present the mobile station shall use its previously assigned frequency parameters. This information element is defined in sub-clause 12.8.

**Frequency Parameters C1, Frequency Parameters C2**

These information elements are coded as defined in sub-clause 12.8. See sub-clause 11.2.7 for the usage of these information elements.

**Dual Carrier Frequency Parameters**

This information element, if present, assigns frequency parameters to the uplink TBF for both carriers in a dual carrier configuration. This information element is defined in sub-clause 12.8.2.

**EXTENDED\_DYNAMIC\_ALLOCATION** (1 bit field)

This information field indicates the medium access mode to be used during the TBF.

0 Dynamic Allocation

1 Extended Dynamic Allocation

**TBF Starting Time**

The TBF Starting Time field contains a starting time that indicates the frame number during which the assigned TBF may start.

In case of dynamic allocation, if no uplink TBF is in progress, the MS need not monitor the USF field until the TDMA frame number occurs. When the indicated TDMA frame number occurs, the mobile station shall immediately begin to monitor the USF field and use the new assigned uplink TBF parameters when its USF has occurred. If an uplink TBF is already in progress, the MS shall continue to use the parameters of the existing TBF until the TDMA frame number occurs. When the indicated TDMA frame number occurs, the mobile station shall immediately begin to monitor the USF field and use the new assigned uplink TBF parameters when its USF has occurred.

In case of single block allocation, the mobile station shall use the assigned timeslot during the RLC/MAC block whose first TDMA burst occurs in the indicated TDMA frame number.

This information element is encoded as the Starting Frame Number Description IE. See sub-clause 12.21.



**MS\_TIMESLOT\_ALLOCATION** (8 bit field)

This information field indicates the timeslots assigned for use by the MS for the assigned uplink TBFs. Bit 8 indicates the status of timeslot 0, bit 7 indicates the status of timeslot 1, etc. At least one timeslot must be assigned. In case of a timeslot allocation without power control parameters, the values of the power control parameters for assigned timeslots shall be the default values as specified in 3GPP TS 45.008. However, in case some of the timeslots assigned by this message are already used by the mobile station, the mobile station shall continue to use the current power control parameters for these timeslots.

- 0 Timeslot is not assigned
- 1 Timeslot is assigned

**TIMESLOT\_ALLOCATION\_C1, TIMESLOT\_ALLOCATION\_C2** (8 bit field)

The usage of these fields is as specified in sub-clause 11.2.7.

At least one timeslot must be assigned. In case of a timeslot allocation without power control parameters, the values of the power control parameters for assigned timeslots shall be the default values as specified in 3GPP TS 45.008.

However, in case some of the timeslots assigned by this message are already used by the mobile station, the mobile station shall continue to use the current power control parameters for these timeslots.

- 0 Timeslot is not assigned
- 1 Timeslot is assigned

**TBF\_TIMESLOT\_ALLOCATION** (N bit field)

This information field indicates the timeslots assigned to a particular uplink TBF, within the timeslots assigned to the MS in the Global Timeslot description. This field contains as many bits as there are timeslots assigned to the MS in the Global Timeslot description. Bit N indicates the status of the lowest numbered timeslot in the timeslots assigned to the MS in the Global Timeslot description. Bit N-1 (if any) indicates the status of the next lowest numbered timeslot, etc. At least one timeslot must be assigned per TBF

- 0 Timeslot is not assigned
- 1 Timeslot is assigned

**USF\_ALLOCATION** (3 bit field)

This field indicates the USF value assigned to the MS for one or more assigned timeslots. This field is encoded as a binary presentation of the USF value as defined in sub-clause 10.4.1.

**USF\_ALLOCATION\_C1, USF\_ALLOCATION\_C2** (3 bit field)

These fields indicate the USF value assigned for all timeslots on the relevant carrier.

If the Assignment Type field is present and indicates 'Dual Carrier assignment', USF\_ALLOCATION\_C1 applies to carrier 1, otherwise it applies to the carrier identified by the Carrier ID field.

If the Assignment Type field is present and indicates 'Dual Carrier assignment', and USF\_ALLOCATION\_C1 is present and USF\_ALLOCATION\_C2 is absent, the value specified by USF\_ALLOCATION\_C1 applies to timeslots assigned on both carriers.

**USF\_GRANULARITY** (1 bit field)

This information field indicates the USF granularity to be applied by the mobile station when it is assigned a TBF using Dynamic Allocation or Extended Dynamic Allocation.

- 0 the mobile station shall transmit one RLC/MAC block
- 1 the mobile station shall transmit four consecutive RLC/MAC blocks

**ALPHA** (4 bit field)

For encoding and description see the Global Power Control Parameters IE.

**ALPHA\_C1, ALPHA\_C2** (4 bit field)

These fields indicate the value of the parameter alpha to be applied in power control. For encoding and description see the Global Power Control Parameters IE. For usage of these parameters, see sub-clause 11.2.29.

<p><b>N_PAIRS</b> (3 bit field)</p> <p>This field indicate the number of PDCH pairs for which GAMMA values are signalled. The number PDCH pairs is given as the binary value of the corresponding field plus one.</p> <p>See Annex K for details of the coding of this field.</p>
<p><b>GAMMA, GAMMA_TN</b> (5 bit field)</p> <p>The field is the binary representation of the parameter <math>\Gamma_{CH}</math> for MS output power control in units of 2 dB, see 3GPP TS 45.008. The field is coded according to the following table:</p> <pre> bit 5 4 3 2 1 0 0 0 0 0    <math>\Gamma_{CH} = 0</math> dB 0 0 0 0 1    <math>\Gamma_{CH} = 2</math> dB ::: 1 1 1 1 0    <math>\Gamma_{CH} = 60</math> dB 1 1 1 1 1    <math>\Gamma_{CH} = 62</math> dB </pre> <p><b>GAMMA_TN_C1</b> (5 bit field), <b>GAMMA_TN_C2</b> (5 bit field)</p> <p>For usage and coding of these parameters, see sub-clause 11.2.29.</p>
<p><b>P0</b> (4 bit field)</p> <p>This field is an optional downlink power control parameter. If P0 is present, then downlink power control is used; otherwise, if P0 is not present, then downlink power control is not used. It is encoded as follows:</p> <pre> bit 4 3 2 1 0 0 0 0    P0 = 0 dB 0 0 0 1    P0 = 2 dB 0 0 1 0    P0 = 4 dB : 1 1 1 1    P0 = 30 dB </pre> <p><b>P0_C1, P0_C2</b> (4 bit field)</p> <p>For the usage of these fields, see sub-clause 11.2.29.</p>
<p><b>PR_MODE</b> (1 bit field)</p> <p>This field indicates the PR Management mode, as defined in 3GPP TS 45.008. It is encoded as follows:</p> <pre> 0 PR mode A: for one addressed MS 1 PR mode B: for all MS </pre> <p><b>PR_MODE_C1, PR_MODE_C2</b> (1 bit field)</p> <p>For the usage of these fields, see sub-clause 11.2.29.</p>
<p><b>Packet Extended Timing Advance</b> (2 bit field)</p> <p>This field is defined in sub-clause 12.12b.</p>
<p><b>NPM Transfer Time</b> (5 bit field)</p> <p>This field contains the NPM Transfer Time limitation in case of RLC non-persistent mode</p> <p>The list of NPM Transfer Time IEs in the Rel-7 additions is ordered as described by the loops in the earlier releases part.</p>
<p><b>Assignment Type</b> (2 bit field)</p> <p>This field is defined in sub-clause 11.2.7.</p>
<p><b>Carrier ID</b> (1 bit field)</p> <p>This identifies the carrier to which the description refers.</p> <pre> 0 Carrier 1 1 Carrier 2 </pre>

<p><b>REPORTED TIMESLOTS</b> (8 bit field)</p> <p>The field indicates the timeslots for which feedback is provided by a time-based encoded PAN field and is encoded as the TIMESLOT_ALLOCATION IE defined in sub-clause 12.18.</p>
<p><b>Uplink TBF Assignment 2 struct</b></p> <p>If the TBF_TIMESLOT_ALLOCATION bitmap is present, then the timeslots/PDCH-pairs assigned to the TBF are a subset of all the timeslots assigned in the Global Timeslot description or PDCH-pairs described in the PDCH-pair description. In BTTI mode, N is the number of timeslots assigned to the MS in the Global Timeslot description. In RTTI mode N is the number of PDCH-pairs described in the PDCH-pair description.</p> <p>If different USFs are assigned on different timeslots/PDCH-pairs, then the USFs are listed in increasing order of timeslot numbers. In BTTI mode, M is the number of timeslots assigned to the TBF in the TBF_TIMESLOT_ALLOCATION if present, else in the Global Timeslot description. In RTTI configurations using RTTI USF mode M is the number of PDCH-pairs assigned to the TBF in the TBF_TIMESLOT_ALLOCATION if present, else M is the number of PDCH-pairs described in the PDCH-pair description. In RTTI configurations using BTTI USF mode M is twice the number of PDCH-pairs assigned to the TBF in the TBF_TIMESLOT_ALLOCATION if present, else M is twice the number of PDCH-pairs described in the PDCH-pair description.</p> <p>If no USF is specified, then the USF value is the same as the previously indicated USF value.</p>
<p><b>PDCH Pairs Description</b></p> <p>This information element is defined in sub-clause 12.5.5.</p>
<p><b>RTTI USF Mode</b> (1 bit field)</p> <p>This field is as specified in the Packet Uplink Assignment message</p>
<p><b>TSH</b> (2 bit field)</p> <p>This field indicates the time-shift between the most recent radio block period for which feedback information is provided and the radio block period when the bitmap is sent:</p> <p>bit</p> <p>2 1</p> <p>0 0 4 TDMA frames (for a basic TTI configuration) or 2 TDMA frames (for a reduced TTI configuration)</p> <p>0 1 8 TDMA frames (for a basic TTI configuration) or 4 TDMA frames (for a reduced TTI configuration)</p> <p>1 0 12 TDMA frames (for a basic TTI configuration) or 6 TDMA frames (for a reduced TTI configuration)</p> <p>1 1 16 TDMA frames (for a basic TTI configuration) or 8 TDMA frames (for a reduced TTI configuration)</p>
<p><b>Uplink EGPRS Level</b> (2 bit field)</p> <p>This field specifies the group of modulation and coding schemes applicable to the TBF(s). This information element is defined in sub-clause 12.10f.</p>
<p><b>Pulse Format</b> (N bits field)</p> <p>This information element, if assigned, specified on which radio frequency channel the mobile station shall transmit using the narrow-band pulse option. The information element is defined in sub-clause 12.8.3.</p>
<p><b>Indication of Upper Layer PDU Start for RLC UM</b> (1 bit field)</p> <p>This field is defined in section 11.2.7a.</p>
<p><b>Enhanced Flexible Timeslot Assignment</b> (1 bit field)</p> <p>This field indicates whether Enhanced Flexible Timeslot Assignment, EFTA, shall be used for all assigned uplink TBFs. This field is coded as follows:</p> <p>0 Enhanced Flexible Timeslot Assignment, EFTA shall not be used for all assigned uplink TBFs.</p> <p>1 Enhanced Flexible Timeslot Assignment, EFTA shall be used for all assigned uplink TBFs.</p>

## 11.2.30 (void)

## 11.2.30a Packet Pause

This optional message is sent on the PACCH from a mobile station with non-GSM capabilities to the network to request a pause of GPRS services.

Message type: PACKET PAUSE

Direction: mobile station to network

**Table 11.2.30a.1: PACKET PAUSE information elements**

< Packet pause message content > ::=
< TLLI : bit (32) >
< RAI : bit (48) >
< padding bits > ;

**Table 11.2.30a.2: PACKET PAUSE information element details**

<b>TLLI</b> (32 bit field) This field contains the TLLI of the mobile station. This field is encoded as defined in sub-clause 12.16.
<b>RAI</b> (48 bit field) This field contains the Routing Area identification. This field is described in 3GPP TS 44.018.

### 11.2.31 Packet Timeslot Reconfigure

This message is sent on the PACCH by the network to the mobile station to assign uplink and downlink resources. If the mobile station supports Downlink Dual Carrier or Downlink Multi Carrier, this message may be sent using extended RLC/MAC control message segmentation (see sub-clause 9.1.12a). A mobile allocation or reference frequency list received as part of this assignment message shall be valid until a new assignment is received or each TBF of the MS are terminated.

Message type: PACKET TIMESLOT RECONFIGURE

Direction: network to mobile station

Classification: non-distribution message

Table 11.2.31.1: PACKET TIMESLOT RECONFIGURE information elements

```

< Packet Timeslot Reconfigure message content > ::=
< PAGE_MODE : bit (2) >
{ 0 < GLOBAL_TFI : < Global TFI IE > >
  { 0 -- Message escape
    { < CHANNEL_CODING_COMMAND : bit (2) >
      < Global Packet Timing Advance : < Global Packet Timing Advance IE > >
      < DOWNLINK_RLC_MODE : bit (1) >
      < CONTROL_ACK : bit (1) >
      { 0 | 1 < DOWNLINK_TFI_ASSIGNMENT : bit (5) > }
      { 0 | 1 < UPLINK_TFI_ASSIGNMENT : bit (5) > }
      < DOWNLINK_TIMESLOT_ALLOCATION : bit (8) >
      { 0 | 1 < Frequency Parameters : < Frequency Parameters IE > > }
      0 -- The value '1' was allocated in an earlier version of the protocol and shall not be used.
      < Dynamic Allocation : < Dynamic Allocation struct > >
      { null | 0 bit** = < no string > -- Receiver backward compatible with earlier version
        | 1 -- Additions for R99
          { 0 | 1 < Packet Extended Timing Advance : bit (2) > }
          { null | 0 bit** = < no string > -- Receiver backward compatible with earlier version
            | 1 -- Additions for Rel-5
              { 0 | 1 < RB Id of downlink TBF : bit (5) >
                < RB Id of uplink TBF : bit (5) > }
              { 0 | 1 < Uplink Control Timeslot : bit (3) > }
              { null | 0 bit** = < no string > -- Receiver backward compatible
                | 1 -- Additions for Rel-6
                  { 0 | 1 < PFI of downlink TBF : bit (7) > }
                  { 0 | 1 < PFI of uplink TBF : bit (7) > }
                  { 0 | 1 < UPLINK_RLC_MODE : bit (1) > }
                  { 0 < EMST_NW_Capability : bit (1) > -- EMST is not used
                    | 1 -- EMST is used
                      { 0
                        | 1 < Downlink RLC Entity 2 : < RLC Entity Struct >
                          { 0
                            | 1 < Downlink RLC Entity 3 : < RLC Entity Struct > }
                          }
                        { 0
                          | 1 < Uplink RLC Entity 2 : < RLC Entity Struct >
                            { 0
                              | 1 < Uplink RLC Entity 3 : < RLC Entity Struct > }
                            }
                        }
                      }
                    }
                  { null | 0 bit** = < no string > -- Receiver backward compatible with earlier version
                    | 1 -- Additions for Rel-10
                      { 0 -- EMSR is not enabled in downlink
                        | 1 -- EMSR is enabled in downlink
                          { 1 < EMSR Additional PFCs 1 : < Additional PFCs struct > > } ** 0
                          { 1 < EMSR Additional PFCs 2 : < Additional PFCs struct > > } ** 0
                          { 1 < EMSR Additional PFCs 3 : < Additional PFCs struct > > } ** 0
                        }
                      { 0 -- EMSR is not enabled in uplink
                        | 1 -- EMSR is enabled in uplink
                          { 1 < EMSR Additional PFCs 1 : < Additional PFCs struct > > } ** 0
                          { 1 < EMSR Additional PFCs 2 : < Additional PFCs struct > > } ** 0
                          { 1 < EMSR Additional PFCs 3 : < Additional PFCs struct > > } ** 0
                        }
                      }
                    { null | 0 bit** = < no string > -- Receiver backward compatible with earlier version
                      | 1 -- Additions for Rel-12
                        < Primary TSC Set : bit (1) >
                        { 0 | 1 -- Secondary DL TSC Value assigned
                          < Secondary DL TSC Set : bit (1) >
                          < Secondary DL TSC Value : bit (3) > }
                        < padding bits > } } }
                    ! < Non-distribution part error : bit (*) = < no string > > }
  }
}

```

```

| 1      -- Message escape bit used to define EGPRS message contents
{ 00 { { 0 | 1 < COMPACT reduced MA : < COMPACT reduced MA IE >> }
      < EGPRS Channel Coding Command : < EGPRS Modulation and Coding Scheme IE >>
      < RESEGMENT : bit (1) >
      { 0 | 1 < DOWNLINK EGPRS Window Size : < EGPRS Window Size IE >> }
      { 0 | 1 < UPLINK EGPRS Window Size : < EGPRS Window Size IE >> }
      < LINK_QUALITY_MEASUREMENT_MODE : bit (2) >
      < Global Packet Timing Advance : < Global Packet Timing Advance IE >>
      { 0 | 1 < Packet Extended Timing Advance : bit (2) > }
      < DOWNLINK_RLC_MODE : bit (1) >
      < CONTROL_ACK : bit (1) >
      { 0 | 1 < DOWNLINK_TFI_ASSIGNMENT : bit (5) > }
      { 0 | 1 < UPLINK_TFI_ASSIGNMENT : bit (5) > }
      < DOWNLINK_TIMESLOT_ALLOCATION : bit (8) >
      { 0 | 1 < Frequency Parameters : < Frequency Parameters IE >> }
      0      -- The value '1' was allocated in an earlier version of the protocol and shall not be used.
      < Dynamic Allocation : < Dynamic Allocation struct >>
      { null | 0 bit** = < no string > -- Receiver backward compatible with earlier version
      | 1      -- Additions for Rel-5
      { 0 | 1 < RB Id of downlink TBF : bit (5) >
        < RB Id of uplink TBF: bit (5) > }
      { 0 | 1 < Uplink Control Timeslot : bit (3) > }
      { null | 0 bit** = < no string > -- Receiver backward compatible
      | 1      -- Additions for Rel-6
      { 0 | 1 < PFI of downlink TBF : bit (7) > }
      { 0 | 1 < PFI of uplink TBF : bit (7) > }
      { 0 | 1 < UPLINK_RLC_MODE : bit (1) > }
      { null | 0 bit** = < no string > -- Receiver backward compatible with earlier version
      | 1      -- Additions for Rel-7
      { 0 | 1 < Downlink NPM Transfer Time : bit (5) > }
      { 0 | 1 < Uplink NPM Transfer Time : bit (5) > }
      { null | 0 bit** = < no string > -- Receiver backward compatible with earlier version
      | 1      -- Additions for Rel-9
      < Indication of Upper Layer PDU Start for RLC UM : bit >
      < Enhanced Flexible Timeslot Assignment : bit >
      { null | 0 bit** = < no string > -- Receiver backward compatible with earlier version
      | 1      -- Additions for Rel-12
      < Primary TSC Set : bit (1) >
      { 0 | 1      -- Secondary DL TSC Value assigned
      < Secondary DL TSC Set : bit (2) >
      < Secondary DL TSC Value : bit (3) > }
      < padding bits > } } } }
      ! < Non-distribution part error : bit (*) = < no string >> }
| 01      -- escape for Downlink Dual Carrier, BTTI using FANR, EGPRS2, RTTI
{ < EGPRS Channel Coding Command : < EGPRS Modulation and Coding Scheme IE >>
  < RESEGMENT : bit (1) >
  < Assignment Info : Assignment Info struct >
  { 0 | 1 < DOWNLINK EGPRS Window Size : < EGPRS Window Size IE >> }
  { 0 | 1 < UPLINK EGPRS Window Size : < EGPRS Window Size IE >> }
  < LINK_QUALITY_MEASUREMENT_MODE : bit (2) >
  { 0 | 1 < BEP_PERIOD2 : bit(4) > }
  < Global Packet Timing Advance : < Global Packet Timing Advance IE >>
  { 0 | 1 < Packet Extended Timing Advance : bit (2) > }
  < DOWNLINK_RLC_MODE : bit (1) >
  < CONTROL_ACK : bit (1) >
  { 0 | 1 < DOWNLINK_TFI_ASSIGNMENT : bit (5) > }

```

```

    { 0          -- BTTI mode
      < TIMESLOT_ALLOCATION_C1 : bit (8) >
      { 0 | 1 < TIMESLOT_ALLOCATION_C2 : bit (8) > }
    | 1          -- RTTI mode
      < RTTI_USF_MODE : bit (1) >
      { 0          -- Single Carrier Assignment
        { 00          -- Default PDCH pair configuration
          | 01          -- Unchanged
          | 10          -- Explicit PDCH pair configuration
            < DOWNLINK_PDCH_PAIRS_C1 : bit (8) >
            < UPLINK_PDCH_PAIRS_C1 : bit (8) >
            ! < PDCH pairs configuration error : { 1 1 } bit (*) = < no string > >      -- reserved
          }
          < RTTI_DOWNLINK_PDCH_PAIR_ASSIGNMENT_SC : bit (4) >
        | 1          -- Dual Carrier Assignment
          { 00          -- Default PDCH pair configuration
            | 01          -- Unchanged
            | 10          -- Explicit PDCH pair configuration
              < DOWNLINK_PDCH_PAIRS_C1 : bit (8) >
              < DOWNLINK_PDCH_PAIRS_C2 : bit (8) >
              < UPLINK_PDCH_PAIRS_C1 : bit (8) >
              < UPLINK_PDCH_PAIRS_C2 : bit (8) >
              ! < PDCH pairs configuration error : { 1 1 } bit (*) = < no string > >      -- reserved
            }
            < RTTI_DOWNLINK_PDCH_PAIR_ASSIGNMENT_DC : bit (8) >
          }
        }
      }
    { 00      -- No frequency parameters included
      | 01      -- Legacy IEs used
        { 0 | 1 < Frequency Parameters C1 : < Frequency Parameters IE > > }
        { 0 | 1 < Frequency Parameters C2 : < Frequency Parameters IE > > }
      | 10      -- Optimized Dual Carrier frequency parameters used
        < Dual Carrier Frequency Parameters : < Dual Carrier Frequency Parameters IE > >
        ! < Frequency Parameters error: { 1 1 } bit(*) = < no string > > -- reserved for future used
      }
    }
  }

```

```

< Dynamic Allocation 2 : < Dynamic Allocation 2 struct > >
{ 0 | 1 < Uplink Control Timeslot C1 : bit (3) > }
{ 0 | 1 < Uplink Control Timeslot C2 : bit (3) > }
{ 0 | 1 < PFI of downlink TBF : bit (7) > }
{ 0 | 1 < PFI of uplink TBF : bit (7) > }
{ 0 | 1 < UPLINK_RLC_MODE : bit (1) > }
{ 0 | 1 < Downlink NPM Transfer Time : bit (5) > }
{ 0 | 1 < Uplink NPM Transfer Time : bit (5) > }
{ 0 -- Fast Ack/Nack Reporting is not activated for the downlink TBF;
| 1 -- Fast Ack/Nack Reporting is activated for the downlink TBF
< EVENT_BASED_FANR: bit (1) > }
{ 0 -- Fast Ack/Nack Reporting is not activated for the uplink TBF
| 1 -- Fast Ack/Nack Reporting is activated for the uplink TBF
  { 0 -- SSN-based encoding is selected
  | 1 -- Time-based encoding is selected
  < REPORTED_TIMESLOTS_C1 : bit (8) > -- carrier 1 in Downlink Dual Carrier
  -- configuration
  { 0 | 1 < REPORTED_TIMESLOTS_C2 : bit (8) > } -- carrier 2 in Downlink Dual Carrier
  -- configuration
  < TSH : bit (2) > } } -- This structure shall be considered only valid if
  -- an uplink TBF is addressed
< Uplink EGPRS Level: < EGPRS Level IE > >
< Downlink EGPRS Level: < EGPRS Level IE > >
{ 0 | 1 < Pulse Format: < Pulse Format IE > > }
{ null | 0 bit** = < no string > -- Receiver backward compatible with earlier version
| 1 -- Additions for Rel-9
  < Indication of Upper Layer PDU Start for RLC UM: bit >
  < Enhanced Flexible Timeslot Assignment : bit >
  { 0 < EMST_NW_Capability : bit (1) > -- EMST is not used
  | 1 -- EMST is used
    { 0
    | 1 < Downlink RLC Entity 2 : < RLC Entity Struct >
      { 0
      | 1 < Downlink RLC Entity 3 : < RLC Entity Struct > }
    }
    { 0
    | 1 < Uplink RLC Entity 2 : < RLC Entity Struct >
      { 0
      | 1 < Uplink RLC Entity 3 : < RLC Entity Struct > }
    }
  }
  { 0 | 1 MTTI_DOWNLINK_ASSIGNMENT_C1 : bit (1) }
  { 0 | 1 MTTI_DOWNLINK_ASSIGNMENT_C2 : bit (1) }
  { 0 | 1 MTTI_UPLINK_ASSIGNMENT_C1 : bit(1) }
  { 0 | 1 MTTI_UPLINK_ASSIGNMENT_C2 : bit(1) }
  { null | 0 bit** = < no string > -- Receiver backward compatible with earlier version
  | 1 -- Additions for Rel-10
    { 0 -- EMSR is not enabled in downlink
    | 1 -- EMSR is enabled in downlink
      { 1 < EMSR Additional PFCs 1 : < Additional PFCs struct > > } ** 0
      { 1 < EMSR Additional PFCs 2 : < Additional PFCs struct > > } ** 0
      { 1 < EMSR Additional PFCs 3 : < Additional PFCs struct > > } ** 0
    }
    { 0 -- EMSR is not enabled in uplink
    | 1 -- EMSR is enabled in uplink
      { 1 < EMSR Additional PFCs 1 : < Additional PFCs struct > > } ** 0
      { 1 < EMSR Additional PFCs 2 : < Additional PFCs struct > > } ** 0
      { 1 < EMSR Additional PFCs 3 : < Additional PFCs struct > > } ** 0
    }
  }
  { null | 0 bit** = < no string > -- Receiver backward compatible with earlier version
  | 1 -- Additions for Rel-11
    < EGPRS Packet Downlink Ack/Nack Type 3 Support : bit(1) >
    { null | 0 bit** = < no string > -- Receiver backward compatible with earlier version
    | 1 -- Additions for Rel-12
      < Primary TSC Set : bit (1) >
      { 0 | 1 -- Secondary DL TSC Value assigned
      < Secondary DL SC Set : bit (2) >
      < Secondary DL TSC Value : bit (3) > }
    }
  }
  < padding bits > } } }
! < Non-distribution part error : bit (*) = < no string > > }

```



```

| 10      -- escape for Downlink Multi Carrier, BTTI using FANR, EGPRS2, RTTI
{ < DOWNLINK_RLC_MODE : bit (1) >
  < CONTROL_ACK : bit (1) >
  { 1 < UFPS : < UFPS struct >> } ** 0
  DLMC Measurement Type : bit (1)
  < LINK_QUALITY_MEASUREMENT_MODE : bit (2) >
  { 0 | 1 < Carrier for          < Global Packet Timing Advance : < Global Packet Timing
Advance IE >>
  { 0 | 1 < Packet Extended Timing Advance : bit (2) > }
  { 0 | 1 < PTCCH_CARRIER : bit (4) > }
  < PDAN Coding : bit (1) >
  < Extended SNS : bit (1) >
  { 0 | 1 < BEP_PERIOD2 : bit(4) > }
  { 0 | 1 < PFI of downlink TBF : bit (7) > }
  { 0 | 1 < Downlink NPM Transfer Time : bit (5) > }
  { 0 | 1      -- '1' indicates Fast Ack/Nack Reporting is activated for downlink TBF
    < EVENT_BASED_FANR: bit (1) > }
  < Downlink EGPRS Level: < EGPRS Level IE >>
  < Indication of Upper Layer PDU Start for RLC UM : bit >
  < EGPRS Packet Downlink Ack/Nack Type 3 Support : bit(1) >
  < EGPRS Channel Coding Command : < EGPRS Modulation and Coding Scheme IE >> }
{ < RESEGMENT : bit (1) >
  { 1 << DLMC UL Carrier Info : < DLMC UL Carrier Info struct >> } ** 0
  { 0 | 1 < UPLINK EGPRS Window Size : < EGPRS Window Size IE >> }
  < UPLINK_TFI_ASSIGNMENT : bit (5) >
  { 0 | 1 < PFI of uplink TBF : bit (7) > }
  { 0 | 1 < UPLINK_RLC_MODE : bit (1) > }
  { 0 | 1 < Uplink NPM Transfer Time : bit (5) > }
  { 0 | 1 -- '1' indicates that FANR is activated
    { 0      -- SSN-based encoding is selected
    | 1      -- Time-based encoding is selected
    < REPORTED_TIMESLOTS : bit (8) >
    < TSH : bit (2) > } }
  < Uplink EGPRS Level: < EGPRS Level IE >>
  { 0 | 1 < Pulse Format: < Pulse Format IE >> }
  < Enhanced Flexible Timeslot Assignment : bit >
  { 0 | 1 < Uplink Control Timeslot : bit (3) > } }
! < Message escape : { 11 } bit (*) = <no string >> }      -- Extended for future changes
! < Address information part error : bit (*) = <no string >> }
! < Distribution part error : bit (*) = <no string >> ;

<Dynamic Allocation struct > ::=
  < EXTENDED_DYNAMIC_ALLOCATION : bit (1) >

```

```

{ 0 | 1 < P0 : bit (4) >
  < PR_MODE : bit (1) > }
< USF_GRANULARITY : bit (1) >
0 -- The value '1' was allocated in an earlier version of the protocol and shall not be used.
{ 0 | 1 < TBF Starting Time : < Starting Frame Number Description IE > > }
{ 0
  -- Timeslot Allocation
  { 0 | 1 < USF_TN0 : bit (3) > }
  { 0 | 1 < USF_TN1 : bit (3) > }
  { 0 | 1 < USF_TN2 : bit (3) > }
  { 0 | 1 < USF_TN3 : bit (3) > }
  { 0 | 1 < USF_TN4 : bit (3) > }
  { 0 | 1 < USF_TN5 : bit (3) > }
  { 0 | 1 < USF_TN6 : bit (3) > }
  { 0 | 1 < USF_TN7 : bit (3) > }
| 1 -- Timeslot Allocation with Power Control Parameters
  < ALPHA : bit (4) >
  { 0 | 1 < USF_TN0 : bit (3) >
    < GAMMA_TN0 : bit (5) > }
  { 0 | 1 < USF_TN1 : bit (3) >
    < GAMMA_TN1 : bit (5) > }
  { 0 | 1 < USF_TN2 : bit (3) >
    < GAMMA_TN2 : bit (5) > }
  { 0 | 1 < USF_TN3 : bit (3) >
    < GAMMA_TN3 : bit (5) > }
  { 0 | 1 < USF_TN4 : bit (3) >
    < GAMMA_TN4 : bit (5) > }
  { 0 | 1 < USF_TN5 : bit (3) >
    < GAMMA_TN5 : bit (5) > }
  { 0 | 1 < USF_TN6 : bit (3) >
    < GAMMA_TN6 : bit (5) > }
  { 0 | 1 < USF_TN7 : bit (3) >
    < GAMMA_TN7 : bit (5) > } } ;

< Dynamic Allocation 2 struct > ::=
< EXTENDED_DYNAMIC_ALLOCATION : bit (1) >
{ 0 | 1 < P0_C1 : bit (4) >
  < PR_MODE_C1 : bit (1) >
  { 0 | 1 < P0_C2 : bit (4) >
    < PR_MODE_C2 : bit (1) > } }
< USF_GRANULARITY : bit (1) >
{ 0 | 1 < UPLINK_TFI_ASSIGNMENT : bit (5) > }
{ 0 -- Allocation without Power Control Parameters
  < N_USF : bit (4) >
  { 0 | 1 < USF : bit (3) > } * ( val(N_USF) + 1 )
| 1 -- Allocation with Power Control Parameters
  < ALPHA_C1 : bit (4) >
  { 0 | 1 < ALPHA_C2 : bit (4) > }
  { 0 -- BTTI mode
    < N_TS : bit (4) >
    { 0 | 1
      < USF : bit (3) >
      < GAMMA : bit (5) >
    } * ( val(N_TS) + 1 )
  | 1 -- RTTI mode
    < N_PAIRS : bit (3) >
    { 0 | 1
      < USF : bit (3) >
      < GAMMA : bit (5) >
    } * ( val(N_PAIRS) + 1 )
    { 0 -- RTTI USF
      | 1 -- BTTI USF
        { 0 | 1 < USF_2 : bit (3) >
          { 0 | 1 < GAMMA : bit (5) > }
        } * ( val(N_PAIRS) + 1 )
    }
  }
}
};

```

```

< Assignment Info struct > ::=
  < Assignment Type : bit (2) >
  < Carrier ID : bit (1) >;

< RLC Entity Struct > ::=
  < TFI : bit (5) >
  < RLC_MODE : bit (1) >
  { 0 | 1 < EGPRS Window Size : < EGPRS Window Size IE > > }
  < PFI : bit (7) >;

< UFPS struct > ::=
  { 00      -- Existing UFPS released
    | 01      -- Existing UFPS remains unchanged (no information provided)
    | 10      -- Existing UFPS changed/new UFPS provided
      { 0      -- Existing DLMC Frequency Parameters unchanged
        | 1 < DLMC Frequency Parameters : < DLMC Frequency Parameters IE > > }
      { 1 < CARRIER_SPECIFIC_INFO : < Carrier Specific Info struct > > } ** 0
    | 11      bit (*) = < no string >      -- Reserved
  };

```

```

< Carrier Specific Info struct > ::=
{ 00      -- Existing carrier released
  | 01      -- Existing carrier remains unchanged (no information provided)
  | 10      -- Existing carrier changed/new carrier provided
    { 0      -- BTTI mode
      { 0      -- same timeslots as the lowest numbered carrier
        | 1 < TIMESLOT_ALLOCATION : bit (8) > }
      | 1      -- RTTI mode
        { 0      -- same PDCH-pairs as the lowest numbered carrier
          | 1 < DOWNLINK_PDCH_PAIRS_DLMC : bit (8) >
            < RTTI_DOWNLINK_PDCH_PAIR_ASSIGNMENT_DLMC : bit (4) > }
        }
      { 0 | 1 < MAIO : bit (6) > }
      { 0      -- same P0 and PR_MODE as the lowest numbered carrier
        | 1 < P0 : bit (4) >
          < PR_MODE : bit (1) > }
      { 0      -- same DOWNLINK_TFI_ASSIGNMENT as the lowest numbered carrier
        | 1 < DOWNLINK_TFI_ASSIGNMENT : bit (5) >
          { 0 | 1 < DOWNLINK_eTFI_ASSIGNMENT : bit (3) > } }
      { 0      -- same Power Control Parameters as the lowest numbered carrier
        | 1 < Power Control Parameters : < Power Control Parameters IE > > }
      { 0      -- EMST is not used on this carrier
        | 1 -- EMST is used on this carrier
          < RLC Entity 2 : < RLC Entity Struct > >
          { 0 | 1 < DOWNLINK_eTFI_ASSIGNMENT : bit (3) > }
          { 0 | 1 < RLC Entity 3 : < RLC Entity Struct > > }
          { 0 | 1 < DOWNLINK_eTFI_ASSIGNMENT : bit (3) > } }
      { 0      -- EMSR is not used on this carrier
        | 1 -- EMSR is used on this carrier
          { 1 < EMSR Additional PFCs 1 : < Additional PFCs struct > >
            { 0 | 1 < DOWNLINK_eTFI_ASSIGNMENT : bit (3) > } } ** 0
          { 1 < EMSR Additional PFCs 2 : < Additional PFCs struct > >
            { 0 | 1 < DOWNLINK_eTFI_ASSIGNMENT : bit (3) > } } ** 0
          { 1 < EMSR Additional PFCs 3 : < Additional PFCs struct > >
            { 0 | 1 < DOWNLINK_eTFI_ASSIGNMENT : bit (3) > } } ** 0
          }
      < Primary TSC Set : bit (1) >
      { 0 | 1      -- Secondary DL TSC Value assigned
        < Secondary DL SC Set : bit (1) >
        < Secondary DL TSC Value : bit (3) > }
    | 11 bit (*) = < no string >      -- Reserved
};

< DLMC UL Carrier Info struct > ::=
{ 00      -- Assigned carrier released
  | 01      -- Carrier remains unchanged (no information provided)
  | 10      -- Assigned carrier modified or new carrier assigned
    { 0      -- BTTI mode
      { 0 | 1 < UPLINK_TIMESLOT_ALLOCATION : bit (8) > }      -- assigned PDCH
      | 1      -- RTTI mode
        { 0 | 1 < UPLINK_PDCH_PAIRS_DLMC : bit (8) > }      -- assigned PDCH-pairs
      }
    < Dynamic Allocation 3 : < Dynamic Allocation 3 IE > >
    { 0      -- EMST is not used on this carrier
      | 1 -- EMST is used on this carrier
        < Uplink RLC Entity 2 : < RLC Entity Struct > >
        { 0 | 1 < Uplink RLC Entity 3 : < RLC Entity Struct > > } }
    { 0      -- EMSR is not used on this carrier
      | 1 -- EMSR is used on this carrier
        { 1 < EMSR Additional PFCs 1 : < Additional PFCs struct > > } ** 0
        { 1 < EMSR Additional PFCs 2 : < Additional PFCs struct > > } ** 0
        { 1 < EMSR Additional PFCs 3 : < Additional PFCs struct > > } ** 0
      }
    < Primary TSC Set : bit (1) >
    | 11 bit (*) = < no string >      -- reserved
};

```

**Table 11.2.31.2: PACKET TIMESLOT RECONFIGURE information element details**

<p><b>Global TFI</b> (6 bit field) This field identifies (one of) the uplink TFI, if available, or (one of) the downlink TFI, to which this message applies. This field is defined in sub-clause 12.10.</p>
<p><b>CHANNEL_CODING_COMMAND</b> (2 bit field) The Channel Coding Indicator field indicates the channel coding scheme that the mobile station shall use when transmitting on the uplink.</p> <p>bit</p> <p>2 1</p> <p>0 0 CS-1</p> <p>0 1 CS-2</p> <p>1 0 CS-3</p> <p>1 1 CS-4</p>
<p><b>COMPACT reduced MA</b> This information element is defined in sub-clause 12.29.</p>
<p><b>EGPRS Modulation and Coding Scheme</b> The EGPRS modulation and coding scheme information element is defined in sub-clause 12.10d.</p> <p>If this field is included in a Dual Carrier assignment, it shall specify the initial EGPRS Modulation and Coding Scheme to be used on both carriers. If this field is included in a Multi Carrier assignment, it shall specify the initial EGPRS Modulation and Coding Scheme to be used on all carriers.</p>
<p><b>RESEGMENT</b> (1 bit field) This field is defined in sub-clause 12.10e.</p>
<p><b>EGPRS Window Size</b> This information element is defined in sub-clause 12.5.2.</p>
<p><b>LINK_QUALITY_MEASUREMENT_MODE</b> (2 bit field) This field is encoded as the LINK_QUALITY_MEASUREMENT_MODE IE of the PACKET DOWNLINK ASSIGNMENT message, as defined in sub-clause 11.2.7.</p>
<p><b>BEP_PERIOD2</b> (4 bit field) This field contains a constant which is used for filtering channel quality measurements in EGPRS. BEP_PERIOD2 when present, or if not, when received in a previous message of the same TBF session, shall be used instead of BEP_PERIOD. For details see 3GPP TS 45.008. Range: 0 to 15</p>
<p><b>Global Packet Timing Advance</b> This information element is defined in sub-clause 12.12a.</p>
<p><b>DOWNLINK_RLC_MODE</b> (1 bit field) <b>RLC_MODE</b> (1 bit field) This field indicates the RLC mode of the requested TBF. If a new mode is assigned by the network for an already established TBF, the MS shall ignore the new assigned mode and shall maintain the TBF in the old mode. If EMST is used, this field indicates the RLC mode of the RLC entity.</p> <p>0 RLC acknowledged mode</p> <p>1 RLC unacknowledged mode. For the case of an EGPRS TBF an MS that supports RLC non-persistent mode shall respond to this indication of RLC mode as described in the EGPRS Window Size IE (see sub-clause 12.5.2).</p>
<p><b>CONTROL_ACK</b> (1 bit field) This field shall be set to '1' if the network establishes a new downlink TBF for the mobile station whose timer T3192 is running. Otherwise this field shall be set to '0'.</p>

**DOWNLINK\_TFI\_ASSIGNMENT** (5 bit field)**TFI** (5 bit field)

This information element, if present, assigns the contained TFI to the mobile station to identify a downlink TBF described by this message. This field is coded the same as the TFI field defined in sub-clause 12.15. If EMSR is supported, each TFI identifies a Packet Flow Context supported by a specific RLC entity allocated on the downlink TBF.

If a DLMC configuration is established, the assignment message shall provide the **DOWNLINK\_TFI\_ASSIGNMENT** IE for at least the first carrier in the corresponding UFPS. If this IE is absent for any remaining carriers, the **DOWNLINK\_TFI\_ASSIGNMENT** IE for the first carrier in the first UFPS shall apply.

**UPLINK\_TFI\_ASSIGNMENT** (5 bit field)**TFI** (5 bit field)

This information element, if present, assigns the contained TFI to the mobile station to identify an uplink TBF described by this message. This field is coded the same as the TFI field defined in sub-clause 12.15. If EMSR is supported, each TFI identifies a Packet Flow Context supported by a specific RLC entity allocated on the uplink TBF.

**DOWNLINK\_TIMESLOT\_ALLOCATION** (8 bit field)**UPLINK\_TIMESLOT\_ALLOCATION** (8 bit field)

This field is defined in sub-clause 12.18.

**TIMESLOT\_ALLOCATION\_C1, TIMESLOT\_ALLOCATION\_C2** (8 bit field)

These fields indicate the assigned timeslots for the downlink TBF. The usage of these fields is as specified in sub-clause 11.2.7.

**Frequency Parameters**

This information element, if present, assigns frequency parameters to the uplink and downlink TBFs. If this information element is not present the mobile station shall use its previously assigned frequency parameters. This information element is defined in sub-clause 12.8.

**Frequency Parameters C1, Frequency Parameters C2**

These information elements are coded as defined in sub-clause 12.8. The usage of these fields is as specified in sub-clause 11.2.7.

**Dual Carrier Frequency Parameters**

This information element, if present, assigns frequency parameters to the uplink TBF for both carriers in a dual carrier configuration. This information element is defined in sub-clause 12.8.2.

**Dynamic Allocation struct**

This information element contains parameters necessary to define the radio resources of a dynamic allocation or an extended dynamic allocation.

**Dynamic Allocation 2 struct**

This information element contains parameters necessary to define the radio resources of a dynamic allocation or an extended dynamic allocation in a dual carrier, RTTI, BTTI with FANR activated, or EGPRS2 configuration.

**Power Control Parameters**

This information element contains parameters necessary to define the radio resources of a dynamic allocation or an extended dynamic allocation in a multi carrier, RTTI, BTTI with FANR activated, or EGPRS2 configuration (see sub-clause 12.13).

In case of a timeslot allocation without power control parameters, the values of the power control parameters for assigned timeslots shall be the default values as specified in 3GPP TS 45.008. However, in case some of the timeslots assigned by this message are already used by the mobile station, the mobile station shall continue to use the current power control parameters for these timeslots.

For the case of a downlink carrier assigned for a DLMC configuration the assignment message shall provide the Power Control Parameters IE for at least the first carrier in the corresponding UFPS. If this IE is absent for any remaining carriers, the Power Control Parameters IE for the first carrier in the first UFPS shall apply.

**EXTENDED\_DYNAMIC\_ALLOCATION** (1 bit field)

This information field indicates the medium access mode to be used during the TBF.

- 0 Dynamic Allocation
- 1 Extended Dynamic Allocation

**TBF Starting Time**

The TBF Starting Time field contains a starting time that indicates the frame number during which the assigned TBF may start.

If no downlink TBF is in progress, the mobile station need not monitor the TFI field of downlink RLC data blocks until the indicated TDMA frame number. After the indicated TDMA frame number, the mobile station shall apply the new downlink parameters and then operate as during a downlink TBF. If a downlink TBF is already in progress, the mobile station shall continue to use the parameters of the existing TBF until the TDMA frame number occurs. When the indicated TDMA frame number occurs, the mobile station shall immediately begin to use the new downlink parameters assigned.

If no uplink TBF is in progress, the MS need not monitor the USF field until the TDMA frame number occurs. When the indicated TDMA frame number occurs, the mobile station shall immediately begin to monitor the USF field and use the new assigned uplink TBF parameters when its USF has occurred. If an uplink TBF is already in progress, the MS shall continue to use the parameters of the existing TBF until the TDMA frame number occurs. When the indicated TDMA frame number occurs, the mobile station shall immediately begin to monitor the USF field and use the new assigned uplink TBF parameters when its USF has occurred.

This field is encoded as the Starting Frame Number Description IE. See sub-clause 12.21

**USF\_TN0** (3 bit field)**USF\_TN1** (3 bit field)**USF\_TN2** (3 bit field)**USF\_TN3** (3 bit field)**USF\_TN4** (3 bit field)**USF\_TN5** (3 bit field)**USF\_TN6** (3 bit field)**USF\_TN7** (3 bit field)

These fields indicate the USF value assigned to the MS for timeslots 0 to 7. These fields are encoded as a binary presentation of the USF value as defined in sub-clause 10.4.1.

**ALPHA** (4 bit field)

For encoding and description see the Global Power Control Parameters IE.

**ALPHA\_C1, ALPHA\_C2** (4 bit field)

The usage of these fields is as specified in sub-clause 11.2.29.2.

**GAMMA, GAMMA\_TN** (5 bit field)

This field is the binary representation of the parameter  $\Gamma_{CH}$  for MS output power control in units of 2 dB, see 3GPP TS 45.008. The field is coded according to the following table:

bit

5 4 3 2 1

0 0 0 0 0  $\Gamma_{CH} = 0$  dB

0 0 0 0 1  $\Gamma_{CH} = 2$  dB

::::

1 1 1 1 0  $\Gamma_{CH} = 60$  dB

1 1 1 1 1  $\Gamma_{CH} = 62$  dB

In the case of RTTI mode with BTTI USF, exactly one GAMMA field shall be included for each PDCH pair for which either one or two USF values are assigned.

<p><b>USF_GRANULARITY</b> (1 bit field) This information field indicates the USF granularity to be applied by the mobile station when it is assigned a TBF using Dynamic Allocation or Extended Dynamic Allocation.</p> <p>0 the mobile station shall transmit one RLC/MAC block 1 the mobile station shall transmit four consecutive RLC/MAC blocks</p>
<p><b>P0, P0_C1, P0_C2</b> (4 bit field) For description and encoding, see the Packet Uplink Assignment message.</p> <p>For the case of a downlink carrier assigned for a DLMC configuration the assignment message shall provide the P0 IE for at least the first carrier in the corresponding UFPS. If this IE is absent for any remaining carriers, the P0 IE for the first carrier in the first UFPS shall apply.</p>
<p><b>PR_MODE, PR_MODE_C1, PR_MODE_C2</b> (1 bit field) For description and encoding, see the Packet Uplink Assignment message.</p> <p>For the case of a downlink carrier assigned for a DLMC configuration the assignment message shall provide the PR_MODE IE for at least the first carrier in the corresponding UFPS. If this IE is absent for any remaining carriers, the PR_MODE IE for the first carrier in the first UFPS shall apply.</p>
<p><b>Packet Extended Timing Advance</b> (2 bit field) This field is defined in sub-clause 12.12b.</p>
<p><b>RB Id of downlink TBF</b> (5 bit field) <b>RB Id of uplink TBF</b> (5 bit field)</p> <p>These fields are included when this message is used to reconfigure TBFs in Iu mode. These fields contain the radio bearer identifier for the radio bearer using the assigned TBF.</p>
<p><b>Uplink Control Timeslot</b> (3 bit field) <b>Uplink Control Timeslot C1</b> (3 bit field) <b>Uplink Control Timeslot C2</b> (3 bit field) For description and coding see the Packet Uplink Assignment message.</p>
<p><b>PFI of downlink TBF</b> (7 bit field) <b>PFI of uplink TBF</b> (7 bit field) <b>TFI</b> (5 bit field)</p> <p>This field contains the PFI parameter identifying a Packet Flow Context related to the TBF identified in the DOWNLINK_TFI_ASSIGNMENT field or UPLINK_TFI_ASSIGNMENT field respectively. The PFI parameter is encoded as the contents of the PFI information element as defined in 3GPP TS 44.018. If EMST is used, this field contains the PFI parameter identifying the Packet Flow Context related to the RLC entity. If EMSR is supported, each TFI identifies a Packet Flow Context supported by a specific RLC entity allocated on the uplink/downlink TBF and each PFI identifies a Packet Flow Context supported by a specific RLC entity on the uplink/downlink TBF.</p>
<p><b>UPLINK_RLC_MODE</b> (1 bit field) <b>RLC_MODE</b> (1 bit field)</p> <p>This field contains the RLC mode to be used for the assigned TBF. If a new mode is assigned by the network for an already established TBF, the MS shall ignore the new assigned mode and shall maintain the TBF in the old mode. If EMST is used, this field indicates the RLC mode of the RLC entity.</p> <p>0 RLC acknowledged mode 1 RLC unacknowledged mode. For the case of an EGPRS TBF an MS that supports RLC non-persistent mode shall respond to this indication of RLC mode as described in the EGPRS Window Size IE (see sub-clause 12.5.2).</p>
<p><b>Downlink NPM Transfer Time</b> (5 bit field) <b>Uplink NPM Transfer Time</b> (5 bit field) <b>NPM Transfer Time</b> (5 bit field)</p> <p>This field contains the NPM Transfer Time limitation in case a TBF or an RLC entity, if EMST is used, using RLC non-persistent mode is established with the message. If EMSR is supported this field contains the NPM Transfer Time limitation for a specific Packet Flow Context configured to use RLC non-persistent mode. Otherwise, this field, if present, shall be ignored</p>



<p><b>Assignment Type</b> (2 bit field) This field is defined in sub-clause 11.2.7</p>
<p><b>Carrier ID</b> (1 bit field) This identifies the carrier to which the description refers.</p> <p>0 Carrier 1 1 Carrier 2</p>
<p><b>EVENT_BASED_FANR</b> (1 bit field) This field indicates whether the event-based FANR shall be used for the assigned TBF. This field shall be included if the assignment is for a RTTI configuration.</p> <p>0 The MS shall not use event-based FANR 1 The MS shall use event-based FANR</p>
<p><b>REPORTED TIMESLOTS, REPORTED TIMESLOTS C1, REPORTED TIMESLOTS C2</b> (8 bit field) The field indicates the timeslots for which feedback is provided by a time-based encoded PAN field and is encoded as the TIMESLOT_ALLOCATION IE defined in sub-clause 12.18.</p> <p>If the Assignment Type field is included and indicates 'Assignment on single carrier only' or 'Modification of existing assignment', then REPORTED TIMESLOTS C1 shall apply to the carrier specified in the Carrier ID field. Otherwise, REPORTED TIMESLOTS C1 and REPORTED TIMESLOTS C2 apply to carrier 1 and carrier 2 respectively.</p>
<p><b>DOWNLINK_PDCH_PAIRS_C1</b> <b>DOWNLINK_PDCH_PAIRS_C2</b> <b>DOWNLINK_PDCH_PAIRS_DLMC</b></p> <p>These specify the set of timeslots which make up the downlink PDCH pairs on the respective carrier. The first PDCH pair comprises the two lowest-numbered timeslots for which the corresponding bits are set to '1'; the next PDCH pair comprises the next two lowest-numbered timeslots for which the corresponding bits are set to '1', and so on. Bit 8 indicates the status of timeslot 0, bit 7 indicates the status of timeslot 1, etc. At least two timeslots must be assigned.</p> <p>If the Assignment Type field is included and indicates 'Assignment on single carrier only' or 'Modification of existing assignment', then DOWNLINK_PDCH_PAIRS_C1 shall apply to the carrier specified in the Carrier ID field. Otherwise, DOWNLINK_PDCH_PAIRS_C1 and DOWNLINK_PDCH_PAIRS_C2 apply to carrier 1 and carrier 2 respectively.</p>
<p><b>UPLINK_PDCH_PAIRS_C1</b> <b>UPLINK_PDCH_PAIRS_C2</b> <b>UPLINK_PDCH_PAIRS_DLMC</b></p> <p>These specify the set of timeslots which make up the uplink PDCH pairs on the respective carrier. The first PDCH pair comprises the two lowest-numbered timeslots for which the corresponding bits are set to '1'; the next PDCH pair comprises the next two lowest-numbered timeslots for which the corresponding bits are set to '1', and so on. Bit 8 indicates the status of timeslot 0, bit 7 indicates the status of timeslot 1, etc. At least two timeslots must be assigned.</p> <p>If the Assignment Type field is included and indicates 'Assignment on single carrier only' or 'Modification of existing assignment', then UPLINK_PDCH_PAIRS_C1 shall apply to the carrier specified in the Carrier ID field. Otherwise, UPLINK_PDCH_PAIRS_C1 and UPLINK_PDCH_PAIRS_C2 apply to carrier 1 and carrier 2 respectively.</p>

<p><b>RTTI_DOWNLINK_PDCH_PAIR_ASSIGNMENT_SC</b> (4 bit field)</p> <p>This specifies which of the downlink PDCH pairs are included in the single carrier assignment for the downlink TBF. If the bit number (5 - n) of the <b>RTTI_DOWNLINK_PDCH_PAIR_ASSIGNMENT_SC</b> field is set to '1', then the <i>n</i>th downlink PDCH pair specified in the <b>DOWNLINK_PDCH_PAIRS_C1</b> bitmap, or in the default configuration if so indicated in the message, is included in the downlink assignment (see sub-clause 7.1.3.6).</p>												
<p><b>RTTI_DOWNLINK_PDCH_PAIR_ASSIGNMENT_DC</b> (8 bit field)</p> <p>This specifies which of the downlink PDCH pairs are included in the dual carrier assignment for the downlink TBF. If the bit number (9 - n) of the <b>RTTI_DOWNLINK_PDCH_PAIR_ASSIGNMENT_DC</b> field is set to '1', then the <i>n</i>th downlink PDCH pair specified in the <b>DOWNLINK_PDCH_PAIRS_C1</b> or <b>DOWNLINK_PDCH_PAIRS_C2</b> bitmap, or in the default configuration if so indicated in the message, is included in the downlink assignment (see sub-clause 7.1.3.6).</p>												
<p><b>RTTI_DOWNLINK_PDCH_PAIR_ASSIGNMENT_DLMC</b> (4 bit field)</p> <p>This specifies which of the downlink PDCH pairs are included in the corresponding carrier of the downlink TBF of a DLMC configuration. If the bit number (5 - n) of this field is set to '1', then the <i>n</i>th downlink PDCH pair specified in the <b>DOWNLINK_PDCH_PAIRS_DLMC</b> bitmap is included in the downlink assignment.</p>												
<p><b>USF, N_USF, N_TS, N_PAIRS, USF_2</b></p> <p>These fields are specified and encoded as for the Packet Uplink Assignment message (see sub-clause 11.2.29 and Annex K).</p>												
<p><b>RTTI_USF_MODE</b> (1 bit field)</p> <p>This field is as specified in the Packet Uplink Assignment message</p>												
<p><b>TSH</b> (2 bit field)</p> <p>This field indicates the time-shift between the most recent radio block period for which feedback information is provided and the radio block period when the bitmap is sent:</p> <table border="0"> <tr> <td>bit</td> <td></td> </tr> <tr> <td>2 1</td> <td></td> </tr> <tr> <td>0 0</td> <td>4 TDMA frames (for a basic TTI configuration) or 2 TDMA frames (for a reduced TTI or MTTI configuration)</td> </tr> <tr> <td>0 1</td> <td>8 TDMA frames (for a basic TTI configuration) or 4 TDMA frames (for a reduced TTI or MTTI configuration)</td> </tr> <tr> <td>1 0</td> <td>12 TDMA frames (for a basic TTI configuration) or 6 TDMA frames (for a reduced TTI or MTTI configuration)</td> </tr> <tr> <td>1 1</td> <td>16 TDMA frames (for a basic TTI configuration) or 8 TDMA frames (for a reduced TTI or MTTI configuration)</td> </tr> </table>	bit		2 1		0 0	4 TDMA frames (for a basic TTI configuration) or 2 TDMA frames (for a reduced TTI or MTTI configuration)	0 1	8 TDMA frames (for a basic TTI configuration) or 4 TDMA frames (for a reduced TTI or MTTI configuration)	1 0	12 TDMA frames (for a basic TTI configuration) or 6 TDMA frames (for a reduced TTI or MTTI configuration)	1 1	16 TDMA frames (for a basic TTI configuration) or 8 TDMA frames (for a reduced TTI or MTTI configuration)
bit												
2 1												
0 0	4 TDMA frames (for a basic TTI configuration) or 2 TDMA frames (for a reduced TTI or MTTI configuration)											
0 1	8 TDMA frames (for a basic TTI configuration) or 4 TDMA frames (for a reduced TTI or MTTI configuration)											
1 0	12 TDMA frames (for a basic TTI configuration) or 6 TDMA frames (for a reduced TTI or MTTI configuration)											
1 1	16 TDMA frames (for a basic TTI configuration) or 8 TDMA frames (for a reduced TTI or MTTI configuration)											
<p><b>Uplink EGPRS Level, Downlink EGPRS Level</b> (2 bits field)</p> <p>These fields assign the group of modulation and coding schemes applicable to the uplink and downlink TBFs respectively. This information element is defined in sub-clause 12.10f.</p>												
<p><b>Pulse Format</b> (N bits field)</p> <p>This information element, if assigned, specified on which radio frequency channel the mobile station shall transmit using the narrow-band pulse option. The information element is defined in sub-clause 12.8.3.</p>												
<p><b>Indication of Upper Layer PDU Start for RLC UM</b> (1 bit field)</p> <p>This field is defined in section 11.2.7.</p>												
<p><b>Enhanced Flexible Timeslot Assignment</b> (1 bit field)</p> <p>This field is defined in sub-clause 11.2.29.</p>												
<p><b>EMST_NW_Capability</b> (1 bit field)</p> <p>This information element is defined in sub-clause 11.2.29.</p>												
<p><b>MTTI_UPLINK_ASSIGNMENT_C1</b> (1 bit field)</p> <p><b>MTTI_UPLINK_ASSIGNMENT_C2</b> (1 bit field)</p> <p>These fields are defined in sub-clause 11.2.29</p>												
<p><b>MTTI_DOWNLINK_ASSIGNMENT_C1</b> (1 bit field)</p> <p><b>MTTI_DOWNLINK_ASSIGNMENT_C2</b> (1 bit field)</p> <p>These fields are defined in sub-clause 11.2.7</p>												

<b>EMSR Additional PFCs 1</b> <b>EMSR Additional PFCs 2</b> <b>EMSR Additional PFCs 3</b> These IEs are defined in section 11.2.7.
<b>EGPRS Packet Downlink Ack/Nack Type 3 Support</b> (1 bit field) See sub-clause 11.2.7 (Packet Downlink Assignment message).
<b>UFPS</b> See sub-clause 11.2.7.
<b>DLMC Measurement Type</b> See sub-clause 11.2.7.
See sub-clause 11.2.7.
<b>CARRIER_SPECIFIC_INFO</b> See sub-clause 11.2.7.
<b>DLMC Frequency Parameters</b> See sub-clause 11.2.7.
<b>MAIO</b> (6 bit field) See sub-clause 11.2.7.
<b>DLMC UL Carrier Info</b> See sub-clause 11.2.29.
<b>Dynamic Allocation 3</b> See sub-clause 11.2.29.
<b>PTCCH_CARRIER</b> (4 bit field) See sub-clause 11.2.7.
<b>PDAN Coding</b> (1 bit field) See sub-clause 11.2.7.
<b>DOWNLINK_eTFI_ASSIGNMENT</b> (3 bit field) See sub-clause 11.2.7.
<b>Extended SNS</b> (1 bit field) See sub-clause 11.2.7.
<b>Primary TSC Set</b> (1 bit field) See sub-clause 11.2.7 and 11.2.29.
<b>Secondary DL TSC Set</b> (1 bit field) See sub-clause 11.2.7.
<b>Secondary DL TSC Value</b> (3 bit field) See sub-clause 11.2.7.

### 11.2.31.1 Special requirements in dual transfer mode

Special requirements apply when a TBF is assigned to a mobile station in dual transfer mode or about to enter dual transfer mode, see sub-clauses 11.2.7.1 and 11.2.29.1 of the present document.

## 11.2.31a Multiple TBF Timeslot Reconfigure

This message is sent on the PACCH by the network to the mobile station to assign uplink and downlink resources. If the mobile station supports Downlink Dual Carrier, this message may be sent using extended RLC/MAC control message segmentation (see sub-clause 9.1.12a). A mobile allocation or reference frequency list received as part of this assignment message shall be valid until a new assignment is received or each TBF of the MS are terminated.

Message type: MULTIPLE TBF TIMESLOT RECONFIGURE

Direction: network to mobile station

Classification: non-distribution message

Table 11.2.31a.1: MULTIPLE TBF TIMESLOT RECONFIGURE information elements

```

< Multiple TBF Timeslot Reconfigure message content > ::=
  < PAGE_MODE : bit (2) >
  {
    0 < GLOBAL_TFI : < Global TFI IE > >
    {
      0 -- Message escape for GPRS mode TBFs
      {
        { 0 | 1 < CHANNEL_CODING_COMMAND : bit (2) > }
        < Global Packet Timing Advance : < Global Packet Timing Advance IE > >
        { 0 | 1 < Frequency Parameters : < Frequency Parameters IE > > }
        { 0 | 1 < Packet Extended Timing Advance : bit (2) > }
        { 1 < Multiple Downlink Assignment : < Multiple Downlink Assignment struct > > } ** 0
        < Multiple Uplink Assignment : < Multiple Uplink Assignment struct > >
        < padding bits >
      }
      ! < Non-distribution part error : bit (*) = < no string > > }
    }
    1 -- Message escape bit for EGPRS mode TBFs
    {
      00 {
        { 0 | 1 < EGPRS Channel Coding Command : < EGPRS Modulation and Coding Scheme IE > > }
        < RESEGMENT : bit (1) >
        { 0 | 1 < Downlink EGPRS Window Size : < EGPRS Window Size IE > }
        { 0 | 1 { 0 | 1 < Uplink EGPRS Window Size : < EGPRS Window Size IE > > }
          < LINK_QUALITY_MEASUREMENT_MODE : bit (2) >
        }
        { 0 | 1 < BEP_PERIOD2 : bit(4) > }
        < Global Packet Timing Advance : < Global Packet Timing Advance IE > >
        { 0 | 1 < Packet Extended Timing Advance : bit (2) > }
        { 0 | 1 < Frequency Parameters : < Frequency Parameters IE > > }
        { 1 < Multiple Downlink Assignment : < Multiple Downlink Assignment struct > > } ** 0
        < Multiple Uplink Assignment : < Multiple Uplink Assignment struct > >
        { null | 0 bit** = < no string > -- Receiver backward compatible with earlier version
          | 1 -- Additions for Rel-7
            { 0 | 1 < NPM Transfer Time : bit (5) > } ** 0
            { null | 0 bit** = < no string > -- Receiver backward compatible with earlier version
              | 1 -- Additions for Rel-9
                { < Indication of Upper Layer PDU Start for RLC UM : bit > } ** 0
                < Enhanced Flexible Timeslot Assignment : bit >
              }
            }
          }
        < padding bits > }
      }
      ! < Non-distribution part error : bit (*) = < no string > > }
    }
    01 {
      -- Message escape for dual carrier, BTTI with FANR activated, RTTI, EGPRS2
      { 0 | 1 < EGPRS Channel Coding Command : < EGPRS Modulation and Coding Scheme IE > > }
      < RESEGMENT : bit (1) >
      { 0 | 1 < Downlink EGPRS Window Size : < EGPRS Window Size IE > }
      { 0 | 1 { 0 | 1 < Uplink EGPRS Window Size : < EGPRS Window Size IE > > }
        < LINK_QUALITY_MEASUREMENT_MODE : bit (2) >
      }
      { 0 | 1 < BEP_PERIOD2 : bit(4) > }
    }
    < Global Packet Timing Advance : < Global Packet Timing Advance IE > >
    { 0 | 1 < Packet Extended Timing Advance : bit (2) > }
    {
      00 -- No frequency parameters included
      | 01 -- Legacy IEs used
        { 0 | 1 < Frequency Parameters C1 : < Frequency Parameters IE > > }
        { 0 | 1 < Frequency Parameters C2 : < Frequency Parameters IE > > }
      | 10 -- Optimized Dual Carrier frequency parameters used
        < Dual Carrier Frequency Parameters : < Dual Carrier Frequency Parameters IE > >
      }
    ! < Frequency Parameters error: { 11 } bit(*) = < no string > -- reserved for future use
  }
}

```

```

    { 0 | 1          -- BTTI mode
      < FANR: bit (1) >
      { 1 < BTTI Multiple Downlink Assignment : < BTTI Multiple Downlink Assignment struct > > } ** 0
    }
    { 0 | 1          -- RTTI mode
      { 0            -- Single Carrier Assignment
        { 00         -- Default PDCH-pair configuration
          | 01         -- Unchanged
          | 10         -- Explicit PDCH pair configuration
          < DOWNLINK_PDCH_PAIRS_C1 : bit (8) >
          < UPLINK_PDCH_PAIRS_C1 : bit (8) >
          ! < PDCH pairs configuration error : { 1 1 } bit (*) = < no string > >      -- reserved
        }
        { 1 < RTTI Multiple Downlink Assignment SC :
          < RTTI Multiple Downlink Assignment SC struct > > } ** 0
      }
      | 1            -- Dual Carrier Assignment
        { 00         -- Default PDCH pair configuration
          | 01         -- Unchanged
          | 10         -- Explicit PDCH pair configuration
          < DOWNLINK_PDCH_PAIRS_C1 : bit (8) >
          < DOWNLINK_PDCH_PAIRS_C2 : bit (8) >
          < UPLINK_PDCH_PAIRS_C1 : bit (8) >
          < UPLINK_PDCH_PAIRS_C2 : bit (8) >
          ! < PDCH pairs configuration error : { 1 1 } bit (*) = < no string > >      -- reserved
        }
        { 1 < RTTI Multiple Downlink Assignment DC :
          < RTTI Multiple Downlink Assignment DC struct > > } ** 0
      }
    }
  }
  { 0 | 1          -- BTTI and/or RTTI mode for uplink
    < Multiple Uplink Assignment : < Multiple Uplink Assignment 2 struct > >
  }
  < Uplink EGPRS Level: < EGPRS Level IE > >
  < Downlink EGPRS Level: < EGPRS Level IE > >
  { 0 | 1 < Pulse Format: < Pulse Format IE > > }
  { null | 0 bit** = < no string > -- Receiver backward compatible with earlier version
    | 1          -- Additions for Rel-9
    { < Indication of Upper Layer PDU Start for RLC UM : bit > } ** 0
      < Enhanced Flexible Timeslot Assignment : bit >
    }
  }
  ! < Non-distribution part error : bit (*) = < no string > >
}
! < Message escape : { 10 | 11 } bit (*) = < no string > >      --Extended for future changes
}
! < Address information part error : bit (*) = < no string > >
}
! < Distribution part error : bit (*) = < no string > > ;

< Multiple Downlink Assignment struct > ::=
  < TIMESLOT_ALLOCATION : bit (8) >
  { 0 | 1 < Uplink Control Timeslot : bit (3) > }
  { 1 < Downlink TBF assignment : < Downlink TBF assignment struct > > } ** 0 ;

< BTTI Multiple Downlink Assignment struct > ::=
  { 0 | 1 < TIMESLOT_ALLOCATION_C1 : bit (8) > }
  { 0 | 1 < TIMESLOT_ALLOCATION_C2 : bit (8) > }
  { 0 | 1 < Uplink Control Timeslot C1 : bit (3) > }
  { 0 | 1 < Uplink Control Timeslot C2 : bit (3) > }
  { 1 < Downlink TBF assignment : < Downlink TBF assignment 2 struct > > } ** 0 ;

< RTTI Multiple Downlink Assignment SC struct > ::=
  < RTTI_DOWNLINK_PDCH_PAIR_ASSIGNMENT_SC : bit (4) >
  { 0 | 1 < Uplink Control Timeslot C1 : bit (3) > }
  { 1 < Downlink TBF assignment : < Downlink TBF assignment 2 struct > > } ** 0 ;

```

```

< RTTI Multiple Downlink Assignment DC struct > ::=
  < RTTI_DOWNLINK_PDCH_PAIR_ASSIGNMENT_DC : bit (8) >
  { 0 | 1 < Uplink Control Timeslot C1 : bit (3) > }
  { 0 | 1 < Uplink Control Timeslot C2 : bit (3) > }
  { 1 < Downlink TBF assignment : < Downlink TBF assignment 2 struct > > } ** 0 ;

< Downlink TBF assignment struct > ::=
  { 0 < RB Id : bit (5) >
  | 1 < PFI : bit (7) >
  < RLC_MODE : bit (1) > }
  { 0 | 1 < Uplink Control Timeslot : bit (3) > }
  < TFI Assignment : bit (5) >
  < CONTROL_ACK : bit (1) >
  { 0 | 1 < Downlink EGPRS Window Size : < EGPRS Window Size IE > > } ;

< Downlink TBF assignment 2 struct > ::=
  < PFI : bit (7) >
  < RLC_MODE : bit (1) >
  { 0 | 1 < Uplink Control Timeslot C1 : bit (3) > }
  { 0 | 1 < Uplink Control Timeslot C2 : bit (3) > }
  < TFI Assignment : bit (5) >
  < CONTROL_ACK : bit (1) >
  { 0 | 1 < NPM Transfer Time : bit (5) > }
  < EVENT_BASED_FANR : bit (1) >
  { 0 | 1 < Downlink EGPRS Window Size : < EGPRS Window Size IE > > } ;

< Multiple Uplink Assignment struct > ::=
  < EXTENDED_DYNAMIC_ALLOCATION : bit (1) >
  { 0 | 1 < P0 : bit (4) >
  < PR_MODE : bit(1) > }
  { 0 | 1 < TBF Starting Time : < Starting Frame Number Description IE > > }
  { 0 | 1 < Global Timeslot description : < Timeslot description struct > >
  { 1 < Uplink TBF Assignment : < Uplink TBF Assignment struct > > } ** 0 } ;

< Multiple Uplink Assignment 2 struct > ::=
  < EXTENDED_DYNAMIC_ALLOCATION : bit (1) >
  { 0 | 1 < P0_C1 : bit (4) >
  < PR_MODE_C1 : bit(1) >
  { 0 | 1 < P0_C2 : bit (4) >
  < PR_MODE_C2 : bit(1) > } }
  { 0 | 1 -- '1' indicates that FANR is activated
  { 0 -- SSN-based encoding is selected
  | 1 -- Time-based encoding is selected
  < TSH : bit (2) > } }
  { 0 | 1
  { 0 | 1 -- BTTI mode
  < Global Timeslot description : < Timeslot description 2 struct > >
  { 1 < Uplink TBF Assignment : < Uplink TBF Assignment 2 struct > > } ** 0
  }
  { 0 | 1 -- RTTI mode
  { 0 -- without power control parameters
  | 1 -- with power control parameters
  < ALPHA_C1 : bit (4) >
  { 0 | 1 < ALPHA_C2 : bit (4) > }
  < N_PAIRS : bit (3) >
  { 0 | 1 < GAMMA : bit (5) > } * (val(N_PAIRS) + 1)
  { 0 -- RTTI USF, or no second GAMMA values are given in case of RTTI mode with BTTI USF
  | 1 -- Second GAMMA values are given in case of RTTI mode with BTTI USF
  { 0 | 1 < GAMMA : bit (5) > } * (val(N_PAIRS) + 1)
  }
  }
  { 1 < Uplink TBF Assignment : < Uplink TBF Assignment 2 struct > >
  < RTTI_USF_MODE : bit (1) > } ** 0
  }
  } ;

```

```

< Timeslot description struct > ::=
{ 0
  < MS_TIMESLOT_ALLOCATION : bit (8) >
| 1
  < ALPHA : bit (4) >
  { 0 | 1 < GAMMA_TN0 : bit (5) > }
  { 0 | 1 < GAMMA_TN1 : bit (5) > }
  { 0 | 1 < GAMMA_TN2 : bit (5) > }
  { 0 | 1 < GAMMA_TN3 : bit (5) > }
  { 0 | 1 < GAMMA_TN4 : bit (5) > }
  { 0 | 1 < GAMMA_TN5 : bit (5) > }
  { 0 | 1 < GAMMA_TN6 : bit (5) > }
  { 0 | 1 < GAMMA_TN7 : bit (5) > } } ;

< Timeslot description 2 struct > ::=
{ 0
  < MS_TIMESLOT_ALLOCATION_C1 : bit (8) >
  { 0 | 1 < MS_TIMESLOT_ALLOCATION_C2 : bit (8) > }
| 1
  < ALPHA_C1 : bit (4) >
  { 0 | 1 < GAMMA_TN0_C1 : bit (5) > }
  { 0 | 1 < GAMMA_TN1_C1 : bit (5) > }
  { 0 | 1 < GAMMA_TN2_C1 : bit (5) > }
  { 0 | 1 < GAMMA_TN3_C1 : bit (5) > }
  { 0 | 1 < GAMMA_TN4_C1 : bit (5) > }
  { 0 | 1 < GAMMA_TN5_C1 : bit (5) > }
  { 0 | 1 < GAMMA_TN6_C1 : bit (5) > }
  { 0 | 1 < GAMMA_TN7_C1 : bit (5) > }
  { 0 | 1 < ALPHA_C2 : bit (4) > }
  { 0 | 1 < GAMMA_TN0_C2 : bit (5) > }
  { 0 | 1 < GAMMA_TN1_C2 : bit (5) > }
  { 0 | 1 < GAMMA_TN2_C2 : bit (5) > }
  { 0 | 1 < GAMMA_TN3_C2 : bit (5) > }
  { 0 | 1 < GAMMA_TN4_C2 : bit (5) > }
  { 0 | 1 < GAMMA_TN5_C2 : bit (5) > }
  { 0 | 1 < GAMMA_TN6_C2 : bit (5) > }
  { 0 | 1 < GAMMA_TN7_C2 : bit (5) > }
};

< Uplink TBF Assignment struct > ::=
{ 0 < RB Id : bit (5) >
| 1 < PFI : bit (7) > }
  < RLC_MODE : bit (1) > }
  < TFI Assignment : bit (5) >
  { 0 | 1 < CHANNEL_CODING_COMMAND : bit (2) > }
  { 0 | 1 < EGPRS Channel Coding Command : < EGPRS Modulation and Coding Scheme IE > > }
  { 0 | 1 < Uplink EGPRS Window Size : < EGPRS Window Size IE > > }
  < USF GRANULARITY : bit (1) >
  { 0
    -- The timeslots assigned to the TBF are all the timeslots assigned
    -- in the Global Timeslot description
  | 1 < TBF_TIMESLOT_ALLOCATION : bit (N) > }
    -- The timeslots assigned to the TBF are a subset of all the
    -- timeslots assigned in the Global Timeslot description. Where
    -- N is the amount of timeslots assigned to the MS in the Global
    -- Timeslot description
  { 0
    < USF_ALLOCATION : bit (3) >
  | 1
    < USF_ALLOCATION : bit (3) >
    -- The same USF is valid on all timeslots assigned to the TBF
    -- Different USF(s) assigned
    -- USF assignment on the lowest numbered timeslot
    -- assigned to the TBF
    { 0 | 1 < USF_ALLOCATION : bit (3) > } * (M-1) ;
    -- USFs on subsequent timeslots assigned to the TBF:
    -- A "0" (respectively a "1" followed by a USF value)
    -- means same (respectively different) USF value as the
    -- USF on the next lower numbered timeslot assigned to
    -- the TBF. Where M is the amount of timeslots assigned
    -- to the TBF in the TBF_TIMESLOT_ALLOCATION if
    -- present, else in the Global Timeslot description

```



```

< Uplink TBF Assignment 2 struct > ::=
  < PFI : bit (7) >
  < RLC_MODE : bit (1) >
  < TFI Assignment : bit (5) >
  { 0 | 1 < EGPRS Channel Coding Command : < EGPRS Modulation and Coding Scheme IE > > }
  { 0 | 1 < EGPRS Window Size : < EGPRS Window Size IE > > }
  { 0 | 1 < NPM Transfer Time : bit (5) > }
  { 0 | 1 < REPORTED TIMESLOTS C1 : bit (8) > -- carrier 1 in Downlink Dual Carrier configuration
    { 0 | 1 < REPORTED TIMESLOTS C2 : bit (8) > } -- carrier 2 in Downlink Dual Carrier configuration
  }
  < USF GRANULARITY : bit (1) >
  { 0 | 1 < TBF_TIMESLOT_ALLOCATION : bit (N) > } -- The timeslots assigned to the TBF are all the timeslots
  -- assigned in the Global Timeslot description
  -- see description in Table 11.2.29a.2

  { 0 < USF_ALLOCATION_C1 : bit (3) >
    { 0 | 1 < USF_ALLOCATION_C2 : bit (3) > } -- The same USF is valid on all timeslots assigned to the TBF
  -- on the respective carriers
  -- Different USF(s) assigned; see description in Table 11.2.29a.2
  | 1
  < USF_ALLOCATION : bit (3) >
  { 0 | 1 < USF_ALLOCATION : bit (3) > } * (M-1) ;

< Assignment Info struct > ::=
  < Assignment Type : bit (2) >
  < Carrier ID : bit (1) > ;

```

Table 11.2.31a.2: MULTIPLE TBF TIMESLOT RECONFIGURE information element details

<p><b>Global TFI</b></p> <p>This information element identifies one of the mobile station's downlink or uplink TFIs. This field is defined in sub-clause 12.10.</p>												
<p><b>CHANNEL_CODING_COMMAND</b> (2 bit field)</p> <p>The Channel Coding Indicator field indicates the channel coding scheme that the mobile station shall use when transmitting on the uplink. If this field is included in the main body of the message, it shall refer to all GPRS TBF mode uplink TBFs assigned in the message (default value). If this field is included in the Uplink TBF Assignment struct, it refers only to the TBF given by the TFI Assignment (this specific value overrules the default value). Every uplink TBF defined in GPRS TBF mode shall be assigned either the default value or a specific value.</p> <table> <tr> <td>bit</td> <td></td> </tr> <tr> <td>2 1</td> <td></td> </tr> <tr> <td>0 0</td> <td>CS-1</td> </tr> <tr> <td>0 1</td> <td>CS-2</td> </tr> <tr> <td>1 0</td> <td>CS-3</td> </tr> <tr> <td>1 1</td> <td>CS-4</td> </tr> </table>	bit		2 1		0 0	CS-1	0 1	CS-2	1 0	CS-3	1 1	CS-4
bit												
2 1												
0 0	CS-1											
0 1	CS-2											
1 0	CS-3											
1 1	CS-4											
<p><b>EGPRS Modulation and Coding Scheme</b></p> <p>The EGPRS modulation and coding scheme information element is defined in sub-clause 12.10d.</p> <p>If this field is included in the main body of the message, it shall refer to all EGPRS TBF mode uplink TBFs assigned in the message (default value). If this field is included in the Uplink TBF Assignment struct, it refers only to the TBF given by the TFI Assignment (this specific value overrules the default value). Every uplink TBF defined in EGPRS TBF mode shall be assigned either the default value or a specific value.</p> <p>If this field is included in a Dual Carrier assignment, it shall specify the initial EGPRS Modulation and Coding Scheme to be used on both carriers.</p>												
<p><b>RESEGMENT</b> (1 bit field)</p> <p>This field is defined in sub-clause 12.10e.</p>												

<p><b>EGPRS Window Size</b> This information element is defined in sub-clause 12.5.2.</p> <p>If this field is included in the main body of the message, it shall refer to all TBFs assigned in the message in the direction indicated (default value). If this field is included in the respective TBF Assignment struct (uplink or downlink), it refers only to the TBF given by the TFI Assignment (this specific value overrides the default value). Every TBF defined in EGPRS TBF mode shall be assigned either the default value or a specific value.</p>
<p><b>LINK_QUALITY_MEASUREMENT_MODE</b> (2 bit field) This field is encoded as the LINK_QUALITY_MEASUREMENT_MODE IE of the PACKET DOWNLINK ASSIGNMENT message, as defined in sub-clause 11.2.7.</p>
<p><b>Global Packet Timing Advance</b> This information element is defined in sub-clause 12.12a.</p>
<p><b>CONTROL_ACK</b> (1 bit field) This field shall be set to "1" if the network wishes to instruct the mobile station to release the given TBFs for which T3192 is running. The TBFs to be released are identified by the TFIs given in the TFI Assignment field and have to be valid on the PACCH on which this message was sent. Otherwise this field shall be set to "0".</p>
<p><b>TFI Assignment</b> (5 bit field) This information element assigns one (or more) TFI(s) to each TBF assigned to the mobile station in this message. This field is repeated for each TBF that is assigned in this message. Optionally, this field may be repeated for each timeslot on which the TBF has been assigned resources. This is in order to assign different TFI values for the same TBF on different resources (BPSCH). TFI values are encoded as defined in sub-clause 12.15.</p>
<p><b>RB Id</b> (5 bit field) This field contains the radio bearer identifier for the radio bearer using the assigned TBF. This provides the mapping of TFI to RB Id which is necessary to uniquely identify Iu-mode data flows.</p>
<p><b>Uplink Control Timeslot</b> (3 bit field) In case of a BTTI configuration, this field contains the timeslot number of the timeslot where the PACCH/U for the MS is located. In case of an RTTI configuration, this field contains the timeslot number of the timeslot belonging to the uplink PDCH pair where the PACCH/U for the MS is located. It is encoded as the binary representation of the timeslot number as defined in 3GPP TS 45.002.</p> <p>If this field is included in the Multiple Downlink Assignment struct, it shall refer to all downlink TBFs assigned in the message. If this field is included in the Downlink TBF assignment struct, it refers only to the TBF given by the TFI Assignment field (this specific value overrides any default value given in the Multiple Downlink Assignment struct). If the Uplink Control Timeslot field is not included in the message at all, then the default rules for the location of PACCH/U apply.</p>
<p><b>Uplink Control Timeslot C1</b> (3 bit field) In case of a BTTI configuration, this field, if present, contains the timeslot number on carrier1 of the timeslot where the PACCH/U for the MS is located. In case of an RTTI configuration, this field contains the timeslot number on carrier1 of the timeslot belonging to the uplink PDCH pair where the PACCH/U for the MS is located. It is encoded as the binary representation of the timeslot number as defined in 3GPP TS 45.002.</p>
<p><b>Uplink Control Timeslot C2</b> (3 bit field) In case of a BTTI configuration, this field, if present, contains the timeslot number on carrier2 of the timeslot where the PACCH/U for the MS is located. In case of an RTTI configuration, this field contains the timeslot number on carrier2 of the timeslot belonging to the uplink PDCH pair where the PACCH/U for the MS is located. It is encoded as the binary representation of the timeslot number as defined in 3GPP TS 45.002.</p> <p>If the Uplink Control Timeslot C1 and/or the Uplink Control Timeslot C2 fields are included in the BTTI Multiple Downlink Assignment struct (respectively RTTI Multiple Downlink Assignment SC / DC struct), they shall refer to all downlink TBFs assigned in the message. If these fields are included in the Downlink TBF assignment 2 struct, they refer only to the TBF given by the TFI Assignment field (the specific values override any default values given in the BTTI Multiple Downlink Assignment struct (respectively RTTI Multiple Downlink Assignment SC / DC struct)). If the Uplink Control Timeslot field is not included in the message at all, then the default rules for the location of PACCH/U apply.</p>

**TIMESLOT\_ALLOCATION** (8 bit field)

This field is defined in sub-clause 12.18.

**TIMESLOT\_ALLOCATION\_C1, TIMESLOT\_ALLOCATION\_C2** (8 bit field)

These information fields indicate the timeslots assigned for use during the TBF on carrier 1 and carrier 2 respectively of a dual carrier configuration. These fields are defined in sub-clause 12.18.

**Frequency Parameters**

This information element, if present, assigns frequency parameters to the uplink and downlink TBFs. If this information element is not present the mobile station shall use its previously assigned frequency parameters. This information element is defined in sub-clause 12.8.

**Frequency Parameters C1, Frequency Parameters C2**

These information elements are coded as defined in sub-clause 12.8. The usage of these parameters is specified in sub-clause 11.2.7.

**Dual Carrier Frequency Parameters**

This information element, if present, assigns frequency parameters to the uplink TBF for both carriers in a dual carrier configuration. This information element is defined in sub-clause 12.8.2.

**EXTENDED\_DYNAMIC\_ALLOCATION** (1 bit field)

This information field indicates the medium access mode to be used during the TBF.

- 0 Dynamic Allocation
- 1 Extended Dynamic Allocation

**TBF Starting Time**

The TBF Starting Time field contains a starting time that indicates the frame number during which the assigned TBF may start.

If no downlink TBF is in progress, the mobile station need not monitor the TFI field of downlink RLC data blocks until the indicated TDMA frame number. After the indicated TDMA frame number, the mobile station shall apply the new downlink parameters and then operate as during a downlink TBF. If a downlink TBF is already in progress, the mobile station shall continue to use the parameters of the existing TBF until the TDMA frame number occurs. When the indicated TDMA frame number occurs, the mobile station shall immediately begin to use the new downlink parameters assigned.

In case of dynamic allocation, if no uplink TBF is in progress, the MS need not monitor the USF field until the TDMA frame number occurs. When the indicated TDMA frame number occurs, the mobile station shall immediately begin to monitor the USF field and use the new assigned uplink TBF parameters when its USF has occurred. If an uplink TBF is already in progress, the MS shall continue to use the parameters of the existing TBF until the TDMA frame number occurs. When the indicated TDMA frame number occurs, the mobile station shall immediately begin to monitor the USF field and use the new assigned uplink TBF parameters when its USF has occurred.

This field is encoded as the Starting Frame Number Description IE. See sub-clause 12.21

**MS\_TIMESLOT\_ALLOCATION** (8 bit field)

This information field indicates the timeslots assigned for use by the MS for the assigned uplink TBFs. Bit 8 indicates the status of timeslot 0, bit 7 indicates the status of timeslot 1, etc. At least one timeslot must be assigned.

- 0 Timeslot is not assigned
- 1 Timeslot is assigned

**MS\_TIMESLOT\_ALLOCATION\_C1, MS\_TIMESLOT\_ALLOCATION\_C2** (8 bit field)

If the Assignment Type field is included and indicates 'Assignment on single carrier only' or 'Modification of existing assignment', then the MS\_TIMESLOT\_ALLOCATION\_C1 field shall apply to the carrier specified in the Carrier ID field. Otherwise, MS\_TIMESLOT\_ALLOCATION\_C1 and MS\_TIMESLOT\_ALLOCATION\_C2 apply to carrier 1 and carrier 2 respectively. These information fields indicate the timeslots assigned for use by the MS for the assigned uplink TBFs.

Bit 8 indicates the status of timeslot 0, bit 7 indicates the status of timeslot 1, etc. If the Assignment Type field is included and indicates 'Dual Carrier assignment' and MS\_TIMESLOT\_ALLOCATION\_C1 is present and MS\_TIMESLOT\_ALLOCATION\_C2 is not present, then the timeslots specified in MS\_TIMESLOT\_ALLOCATION\_C1 apply also to carrier 2.

<p><b>TBF_TIMESLOT_ALLOCATION</b> (N bit field)</p> <p>This information field indicates the timeslots assigned to a particular uplink TBF, within the timeslots assigned to the MS in the Global Timeslot description. This field contains as many bits as there are timeslots assigned to the MS in the Global Timeslot description. Bit N indicates the status of the lowest numbered timeslot in the timeslots assigned to the MS in the Global Timeslot description. Bit N-1 (if any) indicates the status of the next lowest numbered timeslot, etc. At least one timeslot must be assigned per TBF</p> <p>In the case of a dual carrier configuration, the timeslots indicated in the <b>MS_TIMESLOT_ALLOCATION_C1</b> field shall be considered as lower numbered than those in the <b>MS_TIMESLOT_ALLOCATION_C2</b> field.</p> <p>0 Timeslot is not assigned 1 Timeslot is assigned</p>														
<p><b>USF_ALLOCATION</b> (3 bit field)</p> <p>This field indicates the USF value assigned to the MS for one or more assigned timeslots. This field is encoded as a binary presentation of the USF value as defined in sub-clause 10.4.1.</p> <p><b>USF_ALLOCATION_C1, USF_ALLOCATION_C2</b> (3 bit field)</p> <p>For description and encoding, see the Multiple TBF Uplink Assignment message.</p>														
<p><b>USF_Granularity</b> (1 bit field)</p> <p>This information field indicates the USF granularity to be applied by the mobile station when it is assigned a TBF using Dynamic Allocation or Extended Dynamic Allocation.</p> <p>0 the mobile station shall transmit one RLC/MAC block 1 the mobile station shall transmit four consecutive RLC/MAC blocks</p>														
<p><b>ALPHA</b> (4 bit field)</p> <p>For encoding and description see the Global Power Control Parameters IE.</p> <p><b>ALPHA_C1, ALPHA_C2</b> (4 bit field)</p> <p>The usage of these fields is as specified in sub-clause 11.2.29.</p>														
<p><b>N_PAIRS</b> (3 bit field)</p> <p>This field indicate the number of PDCH pairs for which GAMMA values are signalled. The number PDCH pairs is given as the binary value of the corresponding field plus one.</p> <p>See Annex K for details of the coding of this field.</p>														
<p><b>GAMMA, GAMMA_TN</b> (5 bit field)</p> <p>The field is the binary representation of the parameter <math>\Gamma_{CH}</math> for MS output power control in units of 2 dB, see 3GPP TS 45.008. The field is coded according to the following table:</p> <table> <tr> <td>bit</td> <td></td> </tr> <tr> <td>5 4 3 2 1</td> <td></td> </tr> <tr> <td>0 0 0 0 0</td> <td><math>\Gamma_{CH} = 0</math> dB</td> </tr> <tr> <td>0 0 0 0 1</td> <td><math>\Gamma_{CH} = 2</math> dB</td> </tr> <tr> <td>::::</td> <td></td> </tr> <tr> <td>1 1 1 1 0</td> <td><math>\Gamma_{CH} = 60</math> dB</td> </tr> <tr> <td>1 1 1 1 1</td> <td><math>\Gamma_{CH} = 62</math> dB</td> </tr> </table> <p><b>GAMMA_TN_C1</b> (5 bit field) <b>GAMMA_TN_C2</b> (5 bit field)</p> <p>The coding and usage of these fields is as specified for the Packet Uplink Assignment message.</p>	bit		5 4 3 2 1		0 0 0 0 0	$\Gamma_{CH} = 0$ dB	0 0 0 0 1	$\Gamma_{CH} = 2$ dB	::::		1 1 1 1 0	$\Gamma_{CH} = 60$ dB	1 1 1 1 1	$\Gamma_{CH} = 62$ dB
bit														
5 4 3 2 1														
0 0 0 0 0	$\Gamma_{CH} = 0$ dB													
0 0 0 0 1	$\Gamma_{CH} = 2$ dB													
::::														
1 1 1 1 0	$\Gamma_{CH} = 60$ dB													
1 1 1 1 1	$\Gamma_{CH} = 62$ dB													
<p><b>P0, P0_C1, P0_C2</b> (4 bit field)</p> <p>For description and encoding, see the Packet Uplink Assignment message.</p>														
<p><b>PR_MODE, PR_MODE_C1, PR_MODE_C2</b> (1 bit field)</p> <p>For description and encoding, see the Packet Uplink Assignment message.</p>														
<p><b>Packet Extended Timing Advance</b> (2 bit field)</p> <p>This field is defined in sub-clause 12.12b.</p>														

<p><b>PFI</b> (7 bit field)</p> <p>This field contains the PFI parameter identifying a Packet Flow Context. The PFI parameter is encoded as the contents of the PFI information element as defined in 3GPP TS 44.018.</p>
<p><b>RLC_MODE</b> (1 bit field)</p> <p>This field contains the RLC mode to be used for the assigned TBF. If a new mode is assigned by the network for an already established TBF, the MS shall ignore the new assigned mode and shall maintain the TBF in the old mode.</p> <p>0 RLC acknowledged mode  1 RLC unacknowledged mode. For the case of an EGPRS TBF an MS that supports RLC non-persistent mode shall respond to this indication of RLC mode as described in the EGPRS Window Size IE (see sub-clause 12.5.2).</p>
<p><b>NPM Transfer Time</b> (5 bit field)</p> <p>This field contains the NPM Transfer Time limitation in case of RLC non-persistent mode</p> <p>The list of NPM Transfer Time IEs in the Rel-7 additions is ordered as described by the loops in the earlier releases part.</p>
<p><b>Assignment Type</b> (2 bit field)</p> <p>This indicates the type of assignment. The coding of this field is as specified in sub-clause 11.2.7.</p>
<p><b>Carrier ID</b> (1 bit field)</p> <p>This identifies the carrier to which the description refers.</p> <p>0 Carrier 1  1 Carrier 2</p>
<p><b>EVENT_BASED_FANR</b> (1 bit field)</p> <p>For description and coding of this field see the Multiple TBF Downlink Assignment message.</p> <p>The list of EVENT_BASED_FANR IEs in the Rel-7 additions is ordered as described by the loops in the earlier releases part.</p>
<p><b>REPORTED TIMESLOTS C1, REPORTED TIMESLOTS C2</b> (8 bit field)</p> <p>The field indicates the timeslots for which feedback is provided by a time-based encoded PAN field and is encoded as the TIMESLOT_ALLOCATION IE defined in sub-clause 12.18.</p> <p>The list of fields related to the Fast Ack/Nack Reporting procedure in the Rel-7 additions is ordered as described by the loops in the earlier releases part.</p>
<p><b>DOWNLINK_PDCH_PAIRS_C1</b>  <b>DOWNLINK_PDCH_PAIRS_C2</b>  <b>UPLINK_PDCH_PAIRS_C1</b>  <b>UPLINK_PDCH_PAIRS_C2</b>  <b>RTTI_DOWNLINK_PDCH_PAIR_ASSIGNMENT_SC</b>  <b>RTTI_DOWNLINK_PDCH_PAIR_ASSIGNMENT_DC</b></p> <p>These fields are defined in sub-clause 11.2.31</p>
<p><b>RTTI_USF_MODE</b> (1 bit field)</p> <p>This field is as specified in the Packet Uplink Assignment message</p>
<p><b>TSH</b> (2 bit field)</p> <p>This field indicates the time-shift between the most recent radio block period for which feedback information is provided and the radio block period when the bitmap is sent:</p> <p>bit  2 1</p> <p>0 0 4 TDMA frames (for a basic TTI configuration) or 2 TDMA frames (for a reduced TTI configuration)  0 1 8 TDMA frames (for a basic TTI configuration) or 4 TDMA frames (for a reduced TTI configuration)  1 0 12 TDMA frames (for a basic TTI configuration) or 6 TDMA frames (for a reduced TTI configuration)  1 1 16 TDMA frames (for a basic TTI configuration) or 8 TDMA frames (for a reduced TTI configuration)</p>
<p><b>Uplink EGPRS Level, Downlink EGPRS Level</b> (2 bits field)</p> <p>These fields are as specified in the Packet Timeslot Reconfigure message.</p>

<p><b>Pulse Format</b> (N bits field) This information element, if assigned, specified on which radio frequency channel the mobile station shall transmit using the narrow-band pulse option. The information element is defined in sub-clause 12.8.3.</p>
<p><b>FANR</b> (1 bit field) This field indicates whether FANR is activated:</p> <p>0 FANR is activated for the assigned TBFs 1 FANR is not activated for the assigned TBFs</p>
<p><b>Indication of Upper Layer PDU Start for RLC UM</b> (1 bit field) This field is defined in section 11.2.7.</p>
<p><b>Enhanced Flexible Timeslot Assignment</b> (1 bit field) This field is defined in sub-clause 11.2.29a.</p>

### 11.2.32 Additional MS Radio Access Capabilities

This message is sent on the PACCH by the mobile station to the network to inform about radio access capabilities of the mobile station. It shall not be used in *lu mode*.

Message type: Additional MS Radio Access Capabilities

Direction: mobile station to network

**Table 11.2.32.1: ADDITIONAL MS RADIO ACCESS CAPABILITIES information elements**

<pre>&lt; Additional MS Radio Access Capabilities message content &gt; ::= { 0 &lt; Global TFI : &lt; Global TFI IE &gt; &gt;   1 &lt; TLLI : &lt; TLLI IE &gt; &gt; } &lt; MS Radio Access Capability 2 : &lt; MS Radio Access Capability 2 IE &gt; &gt; { null   0 bit ** = &lt; no string &gt; -- Receiver compatible with earlier release   1 -- Additions in Rel-12 { 0   1 &lt; Downlink_eTFI : bit (3) &gt; } &lt; padding bits &gt; } ;</pre>
---

**Table 11.2.32.2: ADDITIONAL MS RADIO ACCESS CAPABILITIES information element details**

<p><b>Global TFI</b> This information element contains the TFI of the mobile station's uplink TBF, if available, or the TFI of the mobile station's downlink TBF. If no TFI is available, this field is omitted. This field is defined in sub-clause 12.10.</p>
<p><b>TLLI IE (32 bit field)</b> This information element is defined in sub-clause 12.16.</p>
<p><b>MS Radio Access Capability 2</b> This information element is defined in sub-clause 12.30. This information element is sent during one phase and two phase access procedures.</p>
<p><b>DOWNLINK_eTFI (3 bit field)</b> See sub-clause 11.2.48</p>

### 11.2.33 Handover Access (*lu mode only*)

This message is sent on DBPSCH on either PACCH, FACCH or SDCCH and optionally on SACCH by the mobile station to the network during a handover procedure as specified in 3GPP TS 44.160 and 3GPP TS 44.118. It shall not be sent on the 52-multiframe structure (SBPSCH). This message is formatted as four identical access bursts on PACCH, FACCH and SDCCH, and as one individual access burst on SACCH. Each access burst shall use the 8-bit access burst format and follow the 8-bit PRACH uplink/PACCH uplink short acknowledgement block format defined in

3GPP TS 44.004. Each access burst is coded as shown in table 11.2.33.1. The order of bit transmission is defined in 3GPP TS 44.004. The numbering, assembling and field mapping conventions defined for RLC/MAC control blocks in sub-clause 10.0b shall apply.

Direction: mobile station to network

**Table 11.2.33.1: HANDOVER ACCESS information elements**

<p>&lt; Handover Access 8 bit message &gt; ::= -- 8-bit access burst format          &lt; <b>HANDOVER_REFERENCE_VALUE</b> : bit (8) &gt;;</p>
---

**Table 11.2.33.2: HANDOVER ACCESS information element details**

<p><b>HANDOVER_REFERENCE_VALUE</b> (8 bit field)          This field is coded as the handover reference value field defined in 3GPP TS 44.018.</p>
--

### 11.2.34 Physical Information (*lu mode only*)

This message is sent on DBPSCH on either PACCH, FACCH or SDCCH by the network to the mobile station during a handover procedure as specified in 3GPP TS 44.160 and 3GPP TS 44.118 to indicate a valid timing advance to the mobile station. It shall not be sent on the 52-multiframe structure (SBPSCH).

Message type: PHYSICAL INFORMATION

Direction: network to mobile station

Classification: DBPSCH message

**Table 11.2.34.1: PHYSICAL INFORMATION information elements**

<p>&lt; Physical information message content &gt; ::= -- RLC/MAC control block format          &lt; <b>MESSAGE_TYPE</b> : bit (6) == 010010 &gt;          &lt; <b>TIMING_ADVANCE_VALUE</b> : bit (8) &gt;          &lt; padding bits &gt;; -- truncation at end of message allowed, bits '0' assumed</p>
--

**Table 11.2.34.2: PHYSICAL INFORMATION information element details**

<p><b>TIMING_ADVANCE_VALUE</b> (8 bit field)          This field is coded as the timing advance value field defined in 3GPP TS 44.018.</p>
--

### 11.2.35 Packet CS Request

This message is sent from the mobile station to the network on the PACCH to request RR connection.

Message type: PACKET CS REQUEST

Direction: mobile station to network

**Table 11.2.35.1: PACKET CS REQUEST information elements**

<p>&lt; Packet CS Request message content &gt; ::=          &lt; <b>GLOBAL_TFI</b> : &lt; Global TFI IE &gt; &gt;          &lt; <b>ESTABLISHMENT_CAUSE</b> : bit (8) &gt;          &lt; padding bits &gt;;</p>
--

**Table 11.2.35.2: PACKET CS REQUEST information element details**

<p><b>Global TFI</b> This information element contains the TFI of the mobile station's downlink TBF or uplink TBF. This field is defined in sub-clause 12.10.</p>
<p><b>ESTABLISHMENT CAUSE</b> (8 bit field) The ESTABLISHMENT CAUSE field indicates the cause value of the RR connection establishment. This field is specified in 3GPP TS 44.018. The mobile station shall neither use cause values referring to answer to paging nor request of PDCH.</p>

## 11.2.36 Packet CS Command

This optional message is sent by the network on the PACCH to encapsulate RR control messages. This message may be segmented across more than two RLC/MAC control block by using extended RLC/MAC control message segmentation.

Message type: PACKET CS COMMAND

Direction: network to mobile station

Classification: non distribution message

**Table 11.2.36.1: Packet CS Command information elements**

<pre> &lt; Packet CS Command message content &gt; ::=   &lt; PAGE_MODE : bit (2) &gt;   {     &lt; GLOBAL_TFI : &lt; Global TFI IE &gt; &gt;     {       &lt; spare : bit (2) &gt;       &lt; CONTAINER_LENGTH : bit (8) &gt;       &lt; CONTAINER_DATA : octet ** &gt;       &lt; padding bits &gt;       ! &lt; Non-distribution part error : bit (*) = &lt; no string &gt; &gt; }       ! &lt; Address information part error : bit (*) = &lt; no string &gt; &gt; }     }   } ! &lt; Distribution part error : bit (*) = &lt; no string &gt; &gt; ; </pre>
--

**Table 11.2.36.2: Packet CS Command information element details**

<p>The Packet CS Command message encapsulates RR control message (e.g. DTM ASSIGNMENT COMMAND, IMMEDIATE ASSIGNMENT or IMMEDIATE ASSIGNMENT REJECT).</p>
<p><b>PAGE_MODE</b> (2 bit field) This field is defined in sub-clause 12.20 and gives the PAGE_MODE parameter valid in the serving cell.</p>
<p><b>Global TFI</b> This information element contains the TFI of the mobile station's downlink TBF or uplink TBF. This field is defined in sub-clause 12.10.</p>
<p><b>CONTAINER_LENGTH</b> (8 bit field) This field indicates the number of CONTAINER_DATA octets that form the specific RR control message and is coded as shown below.</p> <p>Bit 8 7 6 5 4 3 2 1 0 0 0 0 0 0 0 0 No CONTAINER_DATA follows; Spare padding is used to fill the rest of the message; 0 0 0 0 0 0 0 1 CONTAINER_DATA length = 1 octet; .... 1 0 1 0 1 0 0 0 CONTAINER_DATA length = 168 octets;</p> <p>All other values reserved. If a reserved value is received the contents of the container shall be discarded.</p>



**CONTAINER DATA** (n\*8 bits)

The CONTAINER DATA octets forms the actual RR control message content. The information contained in the Packet CS Command message shall exclude the following information elements from the beginning of the RR control message: L2 Pseudo Length; RR management Protocol Discriminator and Skip Indicator.

Extra octets of padding bits at the end of the RR control message may be excluded.

### 11.2.37 Packet CS Release Indication

This message is sent from the network to the mobile station on the PACCH to indicate that the ongoing RR connection will be released. The network may indicate that the mobile station shall maintain its uplink and downlink packet resources used in dual transfer mode or it may convert half-rate PDCH into full-rate PDCH to be used in packet transfer mode or it may reconfigure uplink and/or downlink packet resources to be used in packet transfer mode after the RR connection is released.. If the mobile station supports Downlink Dual Carrier, this message may be sent using extended RLC/MAC control message segmentation (see sub-clause 9.1.12a) if three or more RLC/MAC control blocks are required to send the complete message. A mobile allocation or reference frequency list received as part of this assignment message shall be valid until a new assignment is received or each TBF of the MS are terminated.

With reconfiguration option the network shall assign at least one uplink or downlink TBF.

Message type: PACKET CS RELEASE INDICATION

Direction: network to mobile station

Classification: non-distribution message

Table 11.2.37.1: PACKET CS RELEASE INDICATION information elements

```

< Packet CS Release message content > ::=
  < PAGE_MODE : bit (2) >
  {
    < GLOBAL_TFI : < Global TFI IE > >
    < ENHANCED_DTM_CS_RELEASE_INDICATION : bit >
    < Global Packet Timing Advance : < Global Packet Timing Advance IE > >
    { 00      -- RR connection is released and the MS maintains its DL and/or UL TBF(s)
      < padding bits >      -- Allows future message extension for '00' choice.
    | 01      -- When RR connection is released, PDTCH/H is converted to PDTCH/F
      -- and the MS maintains its DL and/or UL TBF(s)
      < padding bits >      -- Allows future message extension for '01' choice.
    | 10      -- RR connection is released and DL and/or UL TBF(s) are reconfigured
      { 0      -- Message escape for GPRS mode TBFs
        {
          { 0 | 1 < Frequency Parameters : < Frequency Parameters IE > > }
          { 0 | 1 < Packet Extended Timing Advance : bit (2) > }
          { 0 | 1
            -- downlink TBF(s)
            { 1 < Multiple Downlink Assignment : < Multiple Downlink Assignment struct > > } ** 0
          }
          { 0 | 1
            -- uplink TBF(s)
            { 0 | 1 < CHANNEL_CODING_COMMAND : bit (2) > }
            < Multiple Uplink Assignment : < Multiple Uplink Assignment struct > >
          }
        }
      { null | 0 bit** = < no string > -- Receiver backward compatible with earlier version
        | 1      -- Additions for Rel-12
          < Primary TSC Set : bit (1) >
          { 0 | 1
            -- Secondary DL TSC Value assigned
            < Secondary DL TSC Set : bit (1) >
            < Secondary DL TSC Value : bit (3) >
          }
          < padding bits > }
      ! < Non-distribution part error : bit (*) = < no string > > }
    | 1
      -- Message escape bit for EGPRS mode TBFs
      { 00 {
          { 0 | 1 < Frequency Parameters : < Frequency Parameters IE > > }
          { 0 | 1 < Packet Extended Timing Advance : bit (2) > }
          { 0 | 1 < BEP_PERIOD2 : bit(4) > }
          { 0 | 1
            -- downlink TBF(s)
            { 0 | 1 < Downlink EGPRS Window Size : < EGPRS Window Size IE > > }
            < LINK_QUALITY_MEASUREMENT_MODE : bit (2) >
            { 1 < Multiple Downlink Assignment :
              < Multiple Downlink Assignment struct > > } ** 0
          }
        }
      }
  }

```

```

    { 0 | 1          -- uplink TBF(s)
      { 0 | 1 < EGPRS Channel Coding Command :
        < EGPRS Modulation and Coding Scheme IE >> }
      < RESEGMENT : bit (1) >
      { 0 | 1 < Uplink EGPRS Window Size : < EGPRS Window Size IE >> }
      < Multiple Uplink Assignment : < Multiple Uplink Assignment struct >>
    }
  { null | 0 bit** = < no string > -- Receiver backward compatible with earlier version
  | 1          -- Additions for Rel-7
    { 1 { 0 | 1 < NPM Transfer Time : bit (5) > } } ** 0
    { null | 0 bit** = < no string > -- Receiver backward compatible with earlier version
    | 1          -- Additions for Rel-9
      < Enhanced Flexible Timeslot Assignment : bit >
      { 0          -- EMST is not used in DL
      | 1          -- EMST is used in DL
        < Downlink RLC Entity 2 : < RLC Entity struct >
        { 0
        | 1 < Downlink RLC Entity 3 : < RLC Entity struct > }
      }
      { 0          -- EMST is not used in UL
      | 1          -- EMST is used in UL
        < Uplink RLC Entity 2 : < RLC Entity struct >
        { 0
        | 1 < Uplink RLC Entity 3 : < RLC Entity struct > }
      }
    }
  { null | 0 bit** = < no string > -- Receiver backward compatible with earlier version
  | 1          -- Additions for Rel-10
    { 0          -- EMSR is not enabled in downlink
    | 1          -- EMSR is enabled in downlink
      { 1 < EMSR Additional PFCs 1 : < Additional PFCs struct >> } ** 0
      { 1 < EMSR Additional PFCs 2 : < Additional PFCs struct >> } ** 0
      { 1 < EMSR Additional PFCs 3 : < Additional PFCs struct >> } ** 0
    }
    { 0          -- EMSR is not enabled in uplink
    | 1          -- EMSR is enabled in uplink
      { 1 < EMSR Additional PFCs 1 : < Additional PFCs struct >> } ** 0
      { 1 < EMSR Additional PFCs 2 : < Additional PFCs struct >> } ** 0
      { 1 < EMSR Additional PFCs 3 : < Additional PFCs struct >> } ** 0
    }
  }
  { null | 0 bit** = < no string > -- Receiver backward compatible with earlier version
  | 1          -- Additions for Rel-12
    < Primary TSC Set : bit (1) >
    { 0 | 1          -- Secondary DL TSC Value assigned
      < Secondary DL TSC Set : bit (1) >
      < Secondary DL TSC Value : bit (3) >
    }
    < padding bits > } } }
  ! < Non-distribution part error : bit (*) = < no string >>
}
| 01 -- Message escape for Dual Carrier, BTTI with FANR activated, RTTI, EGPRS2
{
  < Assignment Info : Assignment Info struct >
  { 00          -- No frequency parameters included
  | 01          -- Legacy IEs used
    < Frequency Parameters C1 : < Frequency Parameters IE >>
    { 0 | 1 < Frequency Parameters C2 : < Frequency Parameters IE >> }
  | 10          -- Optimized Dual Carrier frequency parameters used
    < Dual Carrier Frequency Parameters : < Dual Carrier Frequency Parameters IE >>
  ! < Frequency parameters error: { 11 } bit (*) = <no string>> -- Reserved for future use
  }
  { 0 | 1 < Packet Extended Timing Advance : bit (2) > }
  < EGPRS mode : < EGPRS mode 2 IE >>
}

```

```

{ null | 0 bit** = < no string > -- Receiver backward compatible with earlier version
| 1
  < Enhanced Flexible Timeslot Assignment : bit >
  { 0 -- EMST is not used in DL
  | 1 < Downlink RLC Entity 2 : < RLC Entity struct > -- EMST is used in DL
    { 0
    | 1 < Downlink RLC Entity 3 : < RLC Entity struct > }
  }
  { 0 -- EMST is not used in UL
  | 1 < Uplink RLC Entity 2 : < RLC Entity struct > -- EMST is used in UL
    { 0
    | 1 < Uplink RLC Entity 3 : < RLC Entity struct > }
  }
}
{ null | 0 bit** = < no string > -- Receiver backward compatible with earlier version
| 1
  -- Additions for Rel-10
  { 0 -- EMSR is not enabled in downlink
  | 1 -- EMSR is enabled in downlink
    { 1 < EMSR Additional PFCs 1 : < Additional PFCs struct > > } ** 0
    { 1 < EMSR Additional PFCs 2 : < Additional PFCs struct > > } ** 0
    { 1 < EMSR Additional PFCs 3 : < Additional PFCs struct > > } ** 0
  }
  { 0 -- EMSR is not enabled in uplink
  | 1 -- EMSR is enabled in uplink
    { 1 < EMSR Additional PFCs 1 : < Additional PFCs struct > > } ** 0
    { 1 < EMSR Additional PFCs 2 : < Additional PFCs struct > > } ** 0
    { 1 < EMSR Additional PFCs 3 : < Additional PFCs struct > > } ** 0
  }
}
{ null | 0 bit** = < no string > -- Receiver backward compatible with earlier version
| 1
  -- Additions for Rel-11
  < EGPRS Packet Downlink Ack/Nack Type 3 Support : bit(1) >
  { null | 0 bit** = < no string > -- Receiver backward compatible with earlier version
  | 1 -- Additions for Rel-12
    < Primary TSC Set : bit (1) >
    { 0 | 1 -- Secondary DL TSC Value assigned
      < Secondary DL TSC Set : bit (1) >
      < Secondary DL TSC Value : bit (3) > }
    < padding bits > } } }
    ! < Non-distribution part error : bit (*) = < no string > > }
    ! < Message escape : { 10 | 11 } bit (*) = < no string > > } -- Extended for future changes
  }
  | 11 -- Reserved for future use. When received it shall be interpreted as "00".
  < padding bits > -- Allows future message extension for '11' choice.
}
! < Address information part error : bit (*) = < no string > > }
! < Distribution part error : bit (*) = < no string > > ;

```

```

< Multiple Downlink Assignment struct > ::=
  < TIMESLOT_ALLOCATION : bit (8) >
  { 0 | 1 < Uplink Control Timeslot : bit (3) > }
  { 1 < Downlink TBF assignment : < Downlink TBF assignment struct > > } ** 0 ;

```

```

< Downlink TBF assignment struct > ::=
  { 0 | 1 < PFI : bit (7) > }
  < DOWNLINK_RLC_MODE : bit (1) >
  { 0 | 1 < Uplink Control Timeslot : bit (3) > }
  < TFI_ASSIGNMENT : bit (5) >
  < CONTROL_ACK : bit (1) >
  { 0 | 1 < Downlink EGPRS Window Size : < EGPRS Window Size IE > > } ;

```

```

< Multiple Uplink Assignment struct > ::=
  < EXTENDED_DYNAMIC_ALLOCATION : bit (1) >
  { 0 | 1 < P0 : bit (4) >
    < PR_MODE : bit(1) > }
  { 0 | 1 < Global Timeslot description : < Timeslot description struct > >
    { 1 < Uplink TBF Assignment : < Uplink TBF Assignment struct > > } ** 0 } ;

```

```

< Timeslot description struct > ::=
{ 0 | 1 < MS_TIMESLOT_ALLOCATION : bit (8) > -- without power control params
| 1 -- with power control params
  < ALPHA : bit (4) >
  { 0 | 1 < GAMMA_TN0 : bit (5) > }
  { 0 | 1 < GAMMA_TN1 : bit (5) > }
  { 0 | 1 < GAMMA_TN2 : bit (5) > }
  { 0 | 1 < GAMMA_TN3 : bit (5) > }
  { 0 | 1 < GAMMA_TN4 : bit (5) > }
  { 0 | 1 < GAMMA_TN5 : bit (5) > }
  { 0 | 1 < GAMMA_TN6 : bit (5) > }
  { 0 | 1 < GAMMA_TN7 : bit (5) > } } ;

< Uplink TBF Assignment struct > ::= -- Recursive for multiple TBFs
{ 0 | 1 < PFI : bit (7) > }
< TFI_ASSIGNMENT : bit (5) >
{ 0 | 1 < CHANNEL_CODING_COMMAND : bit (2) > }
{ 0 | 1 < EGPRS Channel Coding Command : < EGPRS Modulation and Coding Scheme IE > > }
{ 0 | 1 < Uplink EGPRS Window Size : < EGPRS Window Size IE > > }
< USF_GRANULARITY : bit (1) >
{ 0 -- The timeslots assigned to the TBF are all the timeslots assigned
| 1 < TBF_TIMESLOT_ALLOCATION : bit (N) > } -- in the Global Timeslot description
-- The timeslots assigned to the TBF are a subset of all the
-- timeslots assigned in the Global Timeslot description. Where
-- N is the amount of timeslots assigned to the MS in the Global
-- Timeslot description
{ 0 < USF_ALLOCATION : bit (3) > -- The same USF is valid on all timeslots assigned to the TBF
| 1 < USF_ALLOCATION : bit (3) > -- Different USF(s) assigned
-- USF assignment on the lowest numbered timeslot
-- assigned to the TBF
  { 0 | 1 < USF_ALLOCATION : bit (3) > } * (M-1) ; -- USFs on subsequent timeslots assigned to the TBF:
-- A "0" (respectively a "1" followed by a USF value)
-- means same (respectively different) USF value as the
-- USF on the next lower numbered timeslot assigned to
-- the TBF. Where M is the amount of timeslots assigned
-- to the TBF in the TBF_TIMESLOT_ALLOCATION if
-- present, else in the Global Timeslot description

< Assignment Info struct > ::=
  < Assignment Type : bit (2) >
  < Carrier ID : bit (1) > ;

< RLC Entity struct > ::=
  < TFI_ASSIGNMENT : bit (5) >
  < RLC_MODE : bit (1) >
  { 0 | 1 < EGPRS Window Size : < EGPRS Window Size IE > > }
  PFI : bit (7) >;

< Additional PFCs struct > ::=
  < TFI_ASSIGNMENT : bit (5) >
  { 0 | 1 < NPM Transfer Time : bit (5) > }
  < PFI : bit (7) >;

```

Table 11.2.37.2: PACKET CS RELEASE INDICATION information element details

<b>PAGE_MODE</b> (2 bit field) This field is defined in sub-clause 12.20.
<b>Global_TFI</b> This information element contains the TFI of the mobile station's downlink TBF or uplink TBF. This field is defined in sub-clause 12.10.

<p><b>ENHANCED_DTM_CS_RELEASE_INDICATION</b> (1 bit field)</p> <p>The ENHANCED_DTM_CS_RELEASE_INDICATION parameter indicates that the network will perform a delayed release of the RR connection while the mobile station is in dual transfer mode.</p> <p>0           The RR connection is not to be released. 1           The RR connection is to be released.</p> <p>NOTE:      The network should not use value "0" if the PACKET CS RELEASE INDICATION message is used with enhanced DTM CS release procedure. In this case the mobile station shall ignore the message.</p>										
<p><b>Global Packet Timing Advance</b></p> <p>This information element is defined in sub-clause 12.12a.</p>										
<p><b>CHANNEL_CODING_COMMAND</b> (2 bit field)</p> <p>The Channel Coding Indicator field indicates the channel coding scheme that the mobile station shall use when transmitting on the uplink.</p> <p>bit</p> <table> <tr><td>2 1</td><td></td></tr> <tr><td>0 0</td><td>CS-1</td></tr> <tr><td>0 1</td><td>CS-2</td></tr> <tr><td>1 0</td><td>CS-3</td></tr> <tr><td>1 1</td><td>CS-4</td></tr> </table>	2 1		0 0	CS-1	0 1	CS-2	1 0	CS-3	1 1	CS-4
2 1										
0 0	CS-1									
0 1	CS-2									
1 0	CS-3									
1 1	CS-4									
<p><b>Frequency Parameters</b></p> <p>This information element, if present, assigns frequency parameters to the uplink and downlink TBFs. If this information element is not present the mobile station shall use its previously assigned frequency parameters. This information element is defined in sub-clause 12.8.</p> <p><b>Frequency Parameters C1, Frequency Parameters C2</b></p> <p>These information elements assign frequency parameters to the uplink and/or downlink TBFs for carrier 1 and carrier 2, respectively. If the Frequency Parameters C1 information element is not present the mobile station shall use its previously assigned frequency parameters for carrier 1. These information elements are coded as defined in sub-clause 12.8.</p> <p><b>Dual Carrier Frequency Parameters</b></p> <p>This information element, if present, assigns frequency parameters to the uplink and/or downlink TBFs for both carriers in a dual carrier configuration. This information element is defined in sub-clause 12.8.2.</p>										
<p><b>Packet Extended Timing Advance</b> (2 bit field)</p> <p>This field is defined in sub-clause 12.12b.</p>										
<p><b>TIMESLOT_ALLOCATION</b> (8 bit field)</p> <p>This field is defined in sub-clause 12.18.</p>										
<p><b>Uplink Control Timeslot</b> (3 bit field)</p> <p>In case of a BTTI configuration, this field contains the timeslot number of the timeslot where the PACCH/U for the downlink TBF is located. In case of an RTTI configuration, this field contains the timeslot number of the timeslot belonging to the uplink PDCH pair where the PACCH/U for the downlink TBF is located. It is encoded as the binary representation of the timeslot number as defined in 3GPP TS 45.002.</p> <p>If this field is included in the Multiple Downlink Assignment struct, it shall refer to all downlink TBFs assigned in the message. If this field is included in the Downlink TBF assignment struct, it refers only to the TBF given by the TFI Assignment field (this specific value overrides any default value given in the Multiple Downlink Assignment struct). If the Uplink Control Timeslot field is not included in the message at all, then the default rules for the location of PACCH/U apply.</p>										
<p><b>PFI</b> (7 bit field)</p> <p>This field contains the PFI parameter identifying a Packet Flow Context. The PFI parameter is encoded as the contents of the PFI information element as defined in 3GPP TS 44.018. This field shall be included if and only if both the network and mobile station support multiple TBFs. If EMST is used, this field contains the PFI parameter identifying the Packet Flow Context related to the RLC entity. If EMSR is supported, this field contains the PFI parameter identifying a Packet Flow Context supported by a specific RLC entity on the uplink/downlink TBF.</p>										

<p><b>DOWNLINK_RLC_MODE</b> (1 bit field)  <b>RLC_MODE</b> (1 bit field)  See sub-clause 11.2.31 (Packet Timeslot Reconfigure message).</p>
<p><b>TFI_ASSIGNMENT</b> (5 bit field)  This information element assigns one (or more) TFI(s) to each TBF assigned to the mobile station in this message. This field is repeated for each TBF that is assigned in this message. Optionally, this field may be repeated for each timeslot on which the TBF has been assigned resources. TFI values are encoded as defined in sub-clause 12.15. If EMST is used, each TFI identifies an RLC entity allocated on the TBF. If EMSR is supported, each TFI identifies a Packet Flow Context supported by a specific RLC entity allocated on the uplink/downlink TBF.</p>
<p><b>CONTROL_ACK</b> (1 bit field)  If multiple TBFs are supported by both network and mobile station, this field shall be set to "1" if the network wishes to instruct the mobile station to release the given TBFs for which T3192 is running. The TBFs to be released are identified by the TFIs given in the TFI Assignment field and have to be valid on the PACCH on which this message was sent. Otherwise this field shall be set to "0".  If either the network or the mobile station does not support the multiple TBF feature, this field shall be set to '1' if the network establishes a new downlink TBF for the mobile station whose timer T3192 is running. Otherwise this field shall be set to '0'.</p>
<p><b>EGPRS Window Size IE (Uplink EGPRS Window Size, Downlink EGPRS Window Size)</b>  This information element is defined in sub-clause 12.5.2.   If this field is included in the main body of the message, it shall refer to all TBFs assigned in the message in the direction indicated (default value). If this field is included in the respective TBF Assignment struct (uplink or downlink), it refers only to the TBF given by the TFI Assignment (this specific value overrules the default value). Every TBF defined in EGPRS TBF mode shall be assigned either the default value or a specific value.   If this field is included in a Dual Carrier assignment, it shall specify the initial EGPRS Modulation and Coding Scheme to be used on both carriers.</p>
<p><b>EGPRS Modulation and Coding Scheme IE (EGPRS Channel Coding Command)</b>  The EGPRS modulation and coding scheme information element is defined in sub-clause 12.10d.   If this field is included in the main body of the message, it shall refer to all EGPRS TBF mode uplink TBFs assigned in the message (default value). If this field is included in the Uplink TBF Assignment struct, it refers only to the TBF given by the TFI Assignment (this specific value overrules the default value). Every uplink TBF defined in EGPRS TBF mode shall be assigned either the default value or a specific value.</p>
<p><b>RESEGMENT</b> (1 bit field)  This field is defined in sub-clause 12.10e.</p>
<p><b>LINK_QUALITY_MEASUREMENT_MODE</b> (2 bit field)  This field is encoded as the LINK_QUALITY_MEASUREMENT_MODE IE of the PACKET DOWNLINK ASSIGNMENT message, as defined in sub-clause 11.2.7.</p>
<p><b>BEP_PERIOD2</b> (4 bit field)  This field contains a constant which is used for filtering channel quality measurements in EGPRS. BEP_PERIOD2 when present, or if not, when received in a previous message of the same TBF session, shall be used instead of BEP_PERIOD. For details see 3GPP TS 45.008.  Range: 0 to 15</p>
<p><b>EXTENDED_DYNAMIC_ALLOCATION</b> (1 bit field)  This information field indicates the medium access mode to be used during the TBF.   0 Dynamic Allocation  1 Extended Dynamic Allocation</p>
<p><b>P0</b> (4 bit field)  For description and encoding, see the Packet Uplink Assignment message. .</p>
<p><b>PR_MODE</b> (1 bit field)  For description and encoding, see the Packet Uplink Assignment message.</p>
<p><b>MS_TIMESLOT_ALLOCATION</b> (8 bit field)  This information field indicates the timeslots assigned for use by the MS for the assigned uplink TBFs. Bit 8 indicates the status of timeslot 0, bit 7 indicates the status of timeslot 1, etc. At least one timeslot must be assigned.   0 Timeslot is not assigned  1 Timeslot is assigned</p>

<p><b>ALPHA</b> (4 bit field) For encoding and description see the Global Power Control Parameters IE.</p> <p>The usage of these fields is as specified in sub-clause 11.2.29.</p>														
<p><b>GAMMA_TN</b> (5 bit field) The field is the binary representation of the parameter <math>\Gamma_{CH}</math> for MS output power control in units of 2 dB, see 3GPP TS 45.008. The field is coded according to the following table:</p> <table> <tr><td>bit</td><td></td></tr> <tr><td>5 4 3 2 1</td><td></td></tr> <tr><td>0 0 0 0 0</td><td><math>\Gamma_{CH} = 0</math> dB</td></tr> <tr><td>0 0 0 0 1</td><td><math>\Gamma_{CH} = 2</math> dB</td></tr> <tr><td>::::</td><td></td></tr> <tr><td>1 1 1 1 0</td><td><math>\Gamma_{CH} = 60</math> dB</td></tr> <tr><td>1 1 1 1 1</td><td><math>\Gamma_{CH} = 62</math> dB</td></tr> </table>	bit		5 4 3 2 1		0 0 0 0 0	$\Gamma_{CH} = 0$ dB	0 0 0 0 1	$\Gamma_{CH} = 2$ dB	::::		1 1 1 1 0	$\Gamma_{CH} = 60$ dB	1 1 1 1 1	$\Gamma_{CH} = 62$ dB
bit														
5 4 3 2 1														
0 0 0 0 0	$\Gamma_{CH} = 0$ dB													
0 0 0 0 1	$\Gamma_{CH} = 2$ dB													
::::														
1 1 1 1 0	$\Gamma_{CH} = 60$ dB													
1 1 1 1 1	$\Gamma_{CH} = 62$ dB													
<p><b>USF_GRANULARITY</b> (1 bit field) This information field indicates the USF granularity to be applied by the mobile station when it is assigned a TBF using Dynamic Allocation or Extended Dynamic Allocation.</p> <p>0 the mobile station shall transmit one RLC/MAC block 1 the mobile station shall transmit four consecutive RLC/MAC blocks</p>														
<p><b>TBF_TIMESLOT_ALLOCATION</b> (N bit field) This information field indicates the timeslots assigned to a particular uplink TBF, within the timeslots assigned to the MS in the Global Timeslot description. This field contains as many bits as there are timeslots assigned to the MS in the Global Timeslot description. Bit N indicates the status of the lowest numbered timeslot in the timeslots assigned to the MS in the Global Timeslot description. Bit N-1 (if any) indicates the status of the next lowest numbered timeslot, etc. At least one timeslot must be assigned per TBF .</p> <p>In the case of a dual carrier configuration, the timeslots indicated in the <b>MS_TIMESLOT_ALLOCATION_C1</b> field shall be considered as lower numbered than those in the <b>MS_TIMESLOT_ALLOCATION_C2</b> field.</p> <p>0 Timeslot is not assigned 1 Timeslot is assigned</p>														
<p><b>USF_ALLOCATION</b> (3 bit field) This field indicates the USF value assigned to the MS for one or more assigned timeslots. This field is encoded as a binary presentation of the USF value as defined in sub-clause 10.4.1.</p>														
<p><b>Assignment Type</b> (2 bit field) This field is defined in sub-clause 11.2.7.</p>														
<p><b>Carrier ID</b> (1 bit field) This identifies the carrier to which the description refers.</p> <p>0 Carrier 1 1 Carrier 2</p>														
<p><b>NPM Transfer Time</b> (5 bit field) This field contains the NPM Transfer Time limitation for TBF or RLC entity assigned to operate in RLC non-persistent mode. If EMSR is supported this field contains the NPM Transfer Time limitation for a specific Packet Flow Context configured to use RLC non-persistent mode.</p> <p>The list of NPM Transfer Time IEs in the Rel-7 additions is ordered as described by the loops in the earlier releases part.</p>														
<p><b>EGPRS mode 2 IE</b> This information element is defined in sub-clause 12.48a.1.</p>														
<p><b>Enhanced Flexible Timeslot Assignment</b> (1 bit field) See sub-clause 11.2.29 (Packet Uplink Assignment message).</p>														



<b>EMSR Additional PFCs 1</b> <b>EMSR Additional PFCs 2</b> <b>EMSR Additional PFCs 3</b> See sub-clause 11.2.7 (Packet Downlink Assignment message).
<b>EGPRS Packet Downlink Ack/Nack Type 3 Support</b> (1 bit field) See sub-clause 11.2.7 (Packet Downlink Assignment message).
<b>Primary TSC Set</b> (1 bit field) See sub-clause 11.2.7 and 11.2.29.  <b>Secondary DL TSC Set</b> (1 bit field) See sub-clause 11.2.7.
<b>Secondary DL TSC Value</b> (3 bit field) See sub-clause 11.2.7.

### 11.2.38 MBMS Service Request

This message is sent on the PACCH from a mobile station to the network in order to inform about the interest in an MBMS session.

Message type: MBMS SERVICE REQUEST

Direction: mobile station to network

**Table 11.2.38.1: MBMS SERVICE REQUEST information elements**

< MBMS service request message content > ::= <ul style="list-style-type: none"> <li>&lt; TLLI : bit (32) &gt;</li> <li>&lt; TMGI : &lt; TMGI struct &gt; &gt;</li> <li>{ 0   1 &lt; MBMS Session Identity : bit (8) &gt; }</li> <li>&lt; MS_ID Request Indication : bit (1) &gt;</li> <li>&lt; padding bits &gt; ;</li> </ul>
---

**Table 11.2.38.2: MBMS SERVICE REQUEST information element details**

<b>TLLI</b> (32 bit field) This field contains the TLLI of the mobile station. This field is encoded as defined in sub-clause 12.16.
<b>TMGI</b> This field contains the Temporary Mobile Group Identity of the MBMS service that is requested by the mobile station. This field is encoded as defined in sub-clause 12.33.
<b>MBMS Session Identity</b> (8 bit field) The MBMS Session Identity field is included in the message if the request concerns a specific MBMS session, which is known by the mobile station. This field contains the MBMS Session Identity of the concerned MBMS session.
<b>MS_ID Request Indication</b> (1 bit field) This field is used by the mobile station to indicate whether an MS_ID (and thus the possibility to send feedback) is requested by the mobile station. If no MS_ID is requested, the mobile station will not be counted by the network for the given MBMS session (that does not however prevent the network from addressing and assigning the mobile station an MS_ID, if available and the network wishes to do so).  0 MS_ID is not requested 1 MS_ID is requested

### 11.2.39 MBMS Assignment (Non-distribution)

This message is sent on the PCCCH or on the PACCH from the network to (a) mobile station(s) in order to assign the radio bearer resources for an MBMS session or to notify the mobile station(s) that a radio bearer for that MBMS session is not established in the cell or to reassign the MBMS Bearer Identity for an MBMS radio bearer or to reassign radio resources for an MBMS radio bearer.

Message type: MBMS ASSIGNMENT (NON-DISTRIBUTION)

Direction: network to mobile station

Classification: non-distribution message

**Table 11.2.39.1: MBMS ASSIGNMENT (NON-DISTRIBUTION) information elements**

```

< MBMS Assignment Non-distribution message content > ::=
< PAGE_MODE : bit (2) >
{
  { 0 < Global TFI : < Global TFI IE > >
  | 10 < TLLI / G-RNTI : bit (32) > }
  {
    -- Non-distribution part
    { 0 | 1 < Length Indicator of MS_ID : bit (2) >
      < MS_ID : bit (val (Length Indicator of MS_ID)+1) >
      < Packet Timing Advance : < Packet Timing Advance IE > >
      { 0 | 1 < ALPHA : bit (4) >
        { 0 | 1 < GAMMA : bit (5) > }
      }
    }
  }
  { 0 | 1 < TMGI : < TMGI struct > > }
  { 0 | 1 < MBMS Session Identity : bit (8) > }
  { 00
    -- Assignment reject. No point-to-multipoint channel is established for the MBMS session.
    < Reject cause: bit (2) >
    { 0 | 1 < Estimated Session Duration : bit (8) > }
  | 01
    -- A point-to-multipoint channel is established or reassigned for the MBMS session.
    < MBMS bearer description : < MBMS bearer description struct > >
    < Estimated Session Duration : bit (8) >
    < MBMS In-band Signalling Indicator : < MBMS In-band Signalling Indicator IE > >
  | 10
    -- The MBMS Bearer Identity is reassigned for the MBMS radio bearer.
    { 0 | 1 < MBMS Radio Bearer Starting Time : < bit (16) > > }
    < Length of MBMS Bearer Identity : bit (3) >
    < MBMS Bearer Identity : bit (val (Length of MBMS Bearer Identity)) >
    ! < Message escape : { 11 } bit (*) = < no string > > } -- Extended for future changes
    < padding bits >
    ! < Non-distribution part error : bit (*) = < no string > > }
    ! < Address information part error : bit (*) = < no string > > }
    ! < Distribution part error : bit (*) = < no string > >;
  }
}

< MBMS bearer description struct > ::=
{ 0 | 1 < MBMS Radio Bearer Starting Time : < bit (16) > > }
{ 0 | 1 < Frequency Parameters : < Frequency Parameters IE > > }
< DOWNLINK_TIMESLOT_ALLOCATION : bit (8) >
< Length of MBMS Bearer Identity : bit (3) >
< MBMS Bearer Identity : bit (val (Length of MBMS Bearer Identity)) >
{ 0 | 1 < EGPRS Window Size : < EGPRS Window Size IE > > }
{ 0 | 1 < TIMESLOT_ALLOCATION_UPLINK_FEEDBACK_CHANNEL : bit (3) > }
{ 0 | 1 < NPM Transfer Time : bit (5) > };

```

**Table 11.2.39.2: MBMS ASSIGNMENT (NON-DISTRIBUTION) information element details**

**PAGE\_MODE** (2 bit field)

This field is defined in sub-clause 12.20.

<p><b>Global TFI</b></p> <p>This information element shall always contain the DOWNLINK_TFI field. The most significant bit(s) of the DOWNLINK_TFI field denote(s) the MBMS Bearer Identity of the MBMS radio bearer the message relates to. This field is defined in sub-clause 12.10.</p>														
<p><b>TLLI / G-RNTI</b> (32 bit field)</p> <p>This field contains the TLLI/G-RNTI of the mobile station. This field is encoded as defined in sub-clause 12.16.</p>														
<p><b>MS_ID</b> (1-4 bit field)</p> <p>This field addresses the mobile station, identified by the TLLI, receiving the MBMS radio bearer that is described in this message and identified by the MBMS Bearer Identity. If the MS_ID parameter is already assigned in the IMMEDIATE ASSIGNMENT message (specified in the 3GPP TS 44.018) the network shall omit it in this message. This field is defined in sub-clause 12.35.</p>														
<p><b>Packet Timing Advance</b></p> <p>If the Packet Timing Advance parameter is already allocated in the IMMEDIATE ASSIGNMENT message (specified in the 3GPP TS 44.018) the network shall omit it in this message. This information element is defined in sub-clause 12.12.</p>														
<p><b>ALPHA</b> (4 bit field)</p> <p>If the ALPHA parameter is already allocated in the IMMEDIATE ASSIGNMENT message (specified in the 3GPP TS 44.018) the network shall omit it in this message. For encoding and description see the Global Power Control Parameters IE.</p>														
<p><b>GAMMA</b> (5 bit field)</p> <p>The GAMMA field is the binary representation of the parameter <math>\Gamma_{CH}</math> for MS output power control in units of 2 dB, see 3GPP TS 45.008. If the GAMMA parameter is already allocated in the IMMEDIATE ASSIGNMENT message (specified in the 3GPP TS 44.018) the network shall omit it in this message. The GAMMA field is coded according to the following table:</p> <table> <tr> <td>bit</td> <td></td> </tr> <tr> <td>5 4 3 2 1</td> <td></td> </tr> <tr> <td>0 0 0 0 0</td> <td><math>\Gamma_{CH} = 0</math> dB</td> </tr> <tr> <td>0 0 0 0 1</td> <td><math>\Gamma_{CH} = 2</math> dB</td> </tr> <tr> <td>::::</td> <td></td> </tr> <tr> <td>1 1 1 1 0</td> <td><math>\Gamma_{CH} = 60</math> dB</td> </tr> <tr> <td>1 1 1 1 1</td> <td><math>\Gamma_{CH} = 62</math> dB</td> </tr> </table>	bit		5 4 3 2 1		0 0 0 0 0	$\Gamma_{CH} = 0$ dB	0 0 0 0 1	$\Gamma_{CH} = 2$ dB	::::		1 1 1 1 0	$\Gamma_{CH} = 60$ dB	1 1 1 1 1	$\Gamma_{CH} = 62$ dB
bit														
5 4 3 2 1														
0 0 0 0 0	$\Gamma_{CH} = 0$ dB													
0 0 0 0 1	$\Gamma_{CH} = 2$ dB													
::::														
1 1 1 1 0	$\Gamma_{CH} = 60$ dB													
1 1 1 1 1	$\Gamma_{CH} = 62$ dB													
<p><b>TMGI</b></p> <p>This field contains the Temporary Mobile Group Identity of the MBMS service. This field is encoded as defined in sub-clause 12.33.</p>														
<p><b>MBMS Session Identity</b> (8 bit field)</p> <p>This field contains the MBMS Session Identity of the concerned MBMS session.</p>														
<p><b>Reject cause</b> (2 bit field)</p> <p>This field indicates whether the mobile station is allowed to perform further MBMS packet accesses for this MBMS session.</p> <table> <tr> <td>00</td> <td>No radio bearer established - further MBMS packet accesses allowed for this MBMS session in this cell</td> </tr> <tr> <td>01</td> <td>No radio bearer established - no further MBMS packet accesses allowed for this MBMS session in this cell</td> </tr> <tr> <td>10</td> <td>No radio bearer established - no further MBMS packet accesses allowed for this MBMS session in this Routing Area</td> </tr> <tr> <td>11</td> <td>No radio bearer established - no further MBMS packet accesses allowed for this MBMS session in this PLMN</td> </tr> </table>	00	No radio bearer established - further MBMS packet accesses allowed for this MBMS session in this cell	01	No radio bearer established - no further MBMS packet accesses allowed for this MBMS session in this cell	10	No radio bearer established - no further MBMS packet accesses allowed for this MBMS session in this Routing Area	11	No radio bearer established - no further MBMS packet accesses allowed for this MBMS session in this PLMN						
00	No radio bearer established - further MBMS packet accesses allowed for this MBMS session in this cell													
01	No radio bearer established - no further MBMS packet accesses allowed for this MBMS session in this cell													
10	No radio bearer established - no further MBMS packet accesses allowed for this MBMS session in this Routing Area													
11	No radio bearer established - no further MBMS packet accesses allowed for this MBMS session in this PLMN													
<p><b>Estimated Session Duration</b> (8 bit field)</p> <p>This field contains an estimation of either the duration for the concerned MBMS session or, if the MBMS session is ongoing, the remaining duration for the concerned MBMS session. This information element is defined in sub-clause 12.44.</p>														
<p><b>MBMS In-band Signalling Indicator</b></p> <p>This information element contains the MBMS In-band Signalling Indicator. This information element is defined in sub-clause 12.45.</p>														

<p><b>MBMS Radio Bearer Starting Time</b> (16 bit field)  This field contains a starting time that indicates the frame number from which the data transfer on the assigned MBMS radio bearer may start. The MBMS Radio Bearer Starting Time is encoded as the value part of the type 3 information element <i>Starting Time</i> in 3GPP TS 44.018.</p>
<p><b>Frequency Parameters</b>  If this information element is not present, the same frequency as for the PCCCH or, if the PCCCH is not present in the cell, for the CCCH, on which the network sends this message or the IMMEDIATE ASSIGNMENT message including the <i>Multiple Blocks Packet Downlink Assignment</i> construction and the <i>Packet Channel Description</i> IE specifying the PDCH over which this message is sent (see 3GPP TS 44.018), respectively, shall be used. This information element is defined in sub-clause 12.8.</p>
<p><b>DOWNLINK_TIMESLOT_ALLOCATION</b> (8 bit field)  This field is defined in sub-clause 12.18.</p>
<p><b>Length of MBMS Bearer Identity</b> (3 bit field)  This field indicates the length of the MBMS Bearer Identity. Any value from 1 to 5 inclusive is allowed. All other values are reserved.</p>
<p><b>MBMS Bearer Identity</b> (1-5 bit field)  This field contains the Bearer identity for the MBMS session. This field is defined in sub-clause 12.34.</p>
<p><b>EGPRS Window Size</b>  This information element is defined in sub-clause 12.5.2.</p>
<p><b>TIMESLOT_ALLOCATION_UPLINK_FEEDBACK_CHANNEL</b> (3 bit field)  This field, if present, identifies the timeslot where the uplink feedback channel, on which the MBMS DOWNLINK ACK/NACK reports shall be sent, is located.</p>
<p><b>NPM Transfer Time</b> (5 bit field)  This field is defined in sub-clause 12.45a.</p>

### 11.2.39a MBMS Assignment (Distribution)

This message is sent on the PCCCH or on the PACCH from the network to mobile stations in order to assign the radio bearer resources for an MBMS session or to notify the mobile stations that a radio bearer for that MBMS session is not established in the cell.

Message type: MBMS ASSIGNMENT (DISTRIBUTION)

Direction: network to mobile station

Classification: distribution message

Table 11.2.39a.1: MBMS ASSIGNMENT (DISTRIBUTION) information elements

```

< MBMS Assignment Distribution message content > ::=
  < PAGE_MODE : bit (2) >
  {
    < TMGI : < TMGI struct > >
    { 0 | 1 < MBMS Session Identity : bit (8) > }
    { 0
      -- Assignment reject. No point-to-multipoint channel is established for the MBMS session.
      < Reject cause: bit (2) >
      { 0 | 1 < Estimated Session Duration : bit (8) > }
      | 1
      -- A point-to-multipoint channel is established for the MBMS session.
      < MBMS bearer description : < MBMS bearer description struct > >
      < Estimated Session Duration : bit (8) >
      < MBMS In-band Signalling Indicator : < MBMS In-band Signalling Indicator IE > >
    }
    < padding bits >
    ! < Distribution part error : bit (*) = < no string > > };

< MBMS bearer description struct > ::=
  { 0 | 1 < MBMS Radio Bearer Starting Time : < bit (16) > > }
  { 0 | 1 < Frequency Parameters : < Frequency Parameters IE > > }
  < DOWNLINK_TIMESLOT_ALLOCATION : bit (8) >
  < Length of MBMS Bearer Identity : bit (3) >
  < MBMS Bearer Identity : bit (val (Length of MBMS Bearer Identity) ) >
  { 0 | 1 < EGPRS Window Size : < EGPRS Window Size IE > > }
  { 0 | 1 < TIMESLOT_ALLOCATION_UPLINK_FEEDBACK_CHANNEL : bit (3) > }
  { 0 | 1 < NPM Transfer Time : bit (5) > };

```

Table 11.2.39a.2: MBMS ASSIGNMENT (DISTRIBUTION) information element details

<b>PAGE_MODE</b> (2 bit field) This field is defined in sub-clause 12.20.
<b>TMGI</b> This field contains the Temporary Mobile Group Identity of the MBMS service. This field is encoded as defined in sub-clause 12.33.
<b>MBMS Session Identity</b> (8 bit field) This field contains the MBMS Session Identity of the concerned MBMS session.
<b>Reject cause</b> (2 bit field) This field indicates whether the mobile station is allowed to perform further MBMS packet accesses for this MBMS session.  00 No radio bearer established - further MBMS packet accesses allowed for this MBMS session in this cell 01 No radio bearer established - no further MBMS packet accesses allowed for this MBMS session in this cell 10 No radio bearer established - no further MBMS packet accesses allowed for this MBMS session in this Routing Area 11 No radio bearer established - no further MBMS packet accesses allowed for this MBMS session in this PLMN
<b>Estimated Session Duration</b> (8 bit field) This field contains an estimation of the session duration for the concerned MBMS session. This information element is defined in sub-clause 12.44.
<b>MBMS In-band Signalling Indicator</b> This information element contains the MBMS In-band Signalling Indicator. This information element is defined in sub-clause 12.45.
<b>MBMS Radio Bearer Starting Time</b> (16 bit field) This field contains a starting time that indicates the frame number from which the data transfer on the assigned MBMS radio bearer may start. The MBMS Radio Bearer Starting Time is encoded as the value part of the type 3 information element <i>Starting Time</i> in 3GPP TS 44.018.

<p><b>Frequency Parameters</b>  If this information element is not present, the same frequency as for the PCCCH or, if the PCCCH is not present in the cell, for the CCCH, on which the network sends this message or the IMMEDIATE ASSIGNMENT message including the <i>Multiple Blocks Packet Downlink Assignment</i> construction and the <i>Packet Channel Description</i> IE specifying the PDCH over which this message is sent (see 3GPP TS 44.018), respectively, shall be used. This information element is defined in sub-clause 12.8.</p>
<p><b>DOWNLINK_TIMESLOT_ALLOCATION</b> (8 bit field)  This field is defined in sub-clause 12.18.</p>
<p><b>MBMS Bearer Identity</b> (1-5 bit field)  This field contains the Bearer identity for the MBMS session. This field is defined in sub-clause 12.34.</p>
<p><b>EGPRS Window Size</b>  This information element is defined in sub-clause 12.5.2.</p>
<p><b>TIMESLOT_ALLOCATION_UPLINK_FEEDBACK_CHANNEL</b> (3 bit field)  This field, if present, identifies the timeslot where the uplink feedback channel, on which the MBMS DOWNLINK ACK/NACK reports shall be sent, is located.</p>
<p><b>NPM Transfer Time</b> (5 bit field)  This field is defined in sub-clause 12.45a.</p>

## 11.2.40 MBMS Neighbouring Cell Information

This optional message is sent by the network on the PACCH to provide details of the bearer allocated to a particular MBMS session in a neighbouring cell. This message shall not be segmented across more than one RLC/MAC control block. If not all information fits into one instance of the MBMS NEIGHBOURING CELL INFORMATION message, the information can be distributed over more than one instance of the message.

Message type: MBMS NEIGHBOURING CELL INFORMATION

Direction: network to mobile station

Classification: distribution message

Table 11.2.40.1: MBMS Neighbouring Cell Information information elements

```

< MBMS Neighbouring Cell Information message content > ::=
< PAGE_MODE : bit (2) >
{ 1 < NEIGHBOUR_CELL_INDEX : bit (7) >
  { 0 | 1 < BSIC : bit (6) > }
  < MBMS_PTM_CHANGE_MARK : bit (2) >
  { 1
    < Length of MBMS Bearer Identity : bit (3) >
    < MBMS Bearer Identity : bit (val (Length of MBMS Bearer Identity)) >
    < Absence cause: bit (2) >
  } ** 0 -- End of list of MBMS bearers for which no p-t-m channel description is given in the neighbour cell
  { 1 < MBMS Frequency List : < MBMS Frequency List struct > > } ** 0
  { 1 < MBMS p-t-m Frequency Parameters : < MBMS p-t-m Frequency Parameters struct > >
    < DOWNLINK_TIMESLOT_ALLOCATION : bit (8) > -- default value
    { 1 < Length of Serving MBMS Bearer Identity : bit (3) >
      < Serving MBMS Bearer Identity : bit (val (Length of Serving MBMS Bearer Identity)) >
      < Length of Neighbour MBMS Bearer Identity : bit (3) >
      < Neighbour MBMS Bearer Identity : bit (val (Length of Neighbour MBMS Bearer Identity)) >
      { 0 | 1 < EGPRS Window Size : < EGPRS Window Size IE > > }
      { 0 | 1 < DOWNLINK_TIMESLOT_ALLOCATION : bit (8) > } -- specific value
      { 0 | 1 < TIMESLOT_ALLOCATION_UPLINK_FEEDBACK_CHANNEL : bit (3) > }
      { 0 | 1 < MBMS Radio Bearer Starting Time : < bit (16) > > }
      < MBMS In-band Signalling Indicator : < MBMS In-band Signalling Indicator IE > >
      { 0 | 1 < NPM Transfer Time : bit (5) > }
    } ** 0 -- End of list of MBMS bearer descriptions sharing the same PDCH (frequency parameters)
  } ** 0 -- End of list of PDCHs for this cell
  { 0 | 1 < PBCCH information : < PBCCH information struct > > }
} ** 0 -- End of list of neighbouring cells
{ null | 0 bit** = < no string > -- Receiver compatible with earlier release
| 1 -- Rel-7 additions
  { 1 { 0 | 1 < USF : bit (3) > -- choice bit indicates presence or not of parameters for the MBMS bearer
    { 0 | 1 < MPRACH Control Parameters : < MPRACH Control Parameters IE > > }
  }
} ** 0 -- End of list of MBMS bearers.
-- The list of MBMS bearers is ordered as described by the loops in the earlier releases part.
}
< padding bits >
! < Distribution part error : bit (*) = < no string > > ;

< PBCCH information struct > ::=
< Pb : bit (4) >
< TSC : bit (3) >
< TN : bit (3) >
{ 00 -- non-hopping PBCCH on BCCH carrier
| 01 < ARFCN : bit (10) > -- non-hopping PBCCH
| 1 -- hopping PBCCH, frequency parameters from an MBMS bearer description for this cell
  < Length of Neighbour MBMS Bearer Identity : bit (3) >
  < Neighbour MBMS Bearer Identity : bit (val (Length of Neighbour MBMS Bearer Identity)) >
};

< MBMS Frequency List struct > ::=
< FREQ_LIST_NUMBER : bit (2) >
< Length of Frequency List contents : bit (4) >
< Frequency List contents : octet (val(Length of Frequency List contents) + 3) > ;

< MBMS p-t-m Frequency Parameters struct > ::=
< TSC : bit (3) >
{ 0 < ARFCN : bit (10) >
| 1 < MAIO : bit (6) >
  < HSN : bit (6) >
  < FREQ_LIST_NUMBER : bit (2) > };

```

**Table 11.2.40.2: MBMS Neighbouring Cell Information information element details**

<p><b>PAGE_MODE</b> (2 bit field) This field is defined in sub-clause 12.20 and gives the PAGE_MODE parameter valid in the serving cell.</p>
<p><b>NEIGHBOUR_CELL_INDEX</b> (7 bit field) This information element is the index within the GSM Neighbour Cell list (defined in sub-clause 5.6.3.2) of the cell for which information is provided.</p> <p>If the mobile station has not completed the construction of the GSM Neighbour Cell list (i.e. before the MS has acquired the complete GSM Neighbour Cell list from the BCCH messages, in case the PBCCH is not allocated in the cell), it shall not disregard this message but store the information contained in it.</p>
<p><b>BSIC</b> (6 bit field) This optional field is needed to identify the neighbour cell in case the GSM Neighbour Cell list is only a frequency list, see 3GPP TS 44.060 sub-clause 5.6.3.2.</p>
<p><b>MBMS_PTM_CHANGE_MARK</b> (2 bit field) This field contains the change mark value for the information given for a specific neighbouring cell. This information is used to combine information from multiple instances of the MBMS Neighbouring Cell Information message.</p>
<p><b>MBMS Bearer Identity</b> (1-5 bit field) This field contains the Bearer identity for the MBMS session. This field is defined in sub-clause 12.34.</p>
<p><b>Absence cause</b> (2 bit field) This field indicates why the description of the MBMS bearer for the neighbour cell is not provided in the message.</p> <p>00 Neighbour cell not in the service area for the MBMS service associated with this Bearer identifier 01 No p-t-m bearer established in the neighbour cell for the MBMS service associated with this Bearer identifier 10 p-t-m bearer established in the neighbour cell for this MBMS service, but the description cannot be provided 11 No information available for the MBMS service associated with this bearer identifier</p>
<p><b>Serving MBMS Bearer Identity</b> (1-5 bit field) This field contains the Bearer identity used by the MBMS session in the serving cell. This field is encoded as the MBMS Bearer Identity IE defined in sub-clause 12.34.</p>
<p><b>Neighbour MBMS Bearer Identity</b> (1-5 bit field) This field contains the Bearer identity used by the MBMS session in the neighbour cell. This field is encoded as the MBMS Bearer Identity IE defined in sub-clause 12.34.</p>
<p><b>MBMS p-t-m Frequency Parameters</b> This information provides a description of a hopping or non-hopping radio frequency channel . In case hopping frequency channel is described, a reference to a specified MBMS Frequency List shall be provided. If MBMS Frequency List has not been received by the MS, it shall store this information for possible later use in case such MBMS Frequency List is received.</p>
<p><b>TSC</b> (3 bit field) This field is the binary representation of the training sequence code, see 3GPP TS 45.002. Range: 0 to 7.</p>
<p><b>ARFCN</b> (10 bit field) This field is the binary representation of the absolute radio frequency channel number (ARFCN) defined in 3GPP TS 45.005. Range 0 to 1023.</p>
<p><b>MAIO</b> (6 bit field) This field is the binary representation of the mobile allocation index offset (MAIO), see 3GPP TS 45.002. Range 0 to 63.</p>
<p><b>HSN</b> (6 bit field) This field is the binary representation of the hopping sequence number, see 3GPP TS 45.002. Range: 0 to 63.</p>



<p><b>FREQ_LIST_NUMBER</b> (2 bit field)</p> <p>This field is the binary identification of a MBMS Frequency List provided by an instance of this message, or the binary reference to such. Range: 0 to 3.</p>
<p><b>MBMS Frequency List</b></p> <p>This information contains a set of radio frequency channels. This list shall be identified by the <b>FREQ_LIST_NUMBER</b> field.</p>
<p><b>Frequency List contents</b> (variable length octet string)</p> <p>This variable length octet string is the representation of a set of radio frequency channels defining a GPRS mobile allocation. The encoding of the octet string is defined by the <i>value part</i> of the type 4 information element <i>Frequency List</i>, defined in 3GPP TS 44.018. The allowed formats of the <i>Frequency List</i> information element are the <i>bit map 0</i>, <i>1024 range</i>, <i>512 range</i>, <i>256 range</i>, <i>128 range</i> and <i>variable bit map</i> formats.</p>
<p><b>DOWNLINK_TIMESLOT_ALLOCATION</b> (8 bit field)</p> <p>This information element describes which timeslots are assigned to the MBMS bearer in the neighbouring cell. This field is encoded as the Timeslot Allocation field defined in sub-clause 12.18.</p> <p>The field following the <i>Frequency Parameters</i> information element shall refer to all the MBMS bearers described in the subsequent loop (default value). If this field is provided for a particular MBMS bearer, it refers only to that MBMS bearer (this specific value overrides the default value). Every MBMS bearer shall be assigned either the default value or a specific value.</p>
<p><b>TIMELOT_ALLOCATION_UPLINK_FEEDBACK_CHANNEL</b> (3 bit field)</p> <p>This field indicates the timeslot used for the uplink feedback channel in the neighbour cell. This field is coded as the binary representation of the timeslot number.</p>
<p><b>EGPRS Window Size</b></p> <p>This information element is defined in sub-clause 12.5.2.</p>
<p><b>MBMS Radio Bearer Starting Time</b> (16 bit field)</p> <p>This field contains a starting time that indicates the frame number from which the data transfer on the assigned MBMS radio bearer may start. The MBMS Radio Bearer Starting Time is encoded as the value part of the type 3 information element <i>Starting Time</i> in 3GPP TS 44.018.</p>
<p><b>MBMS In-band Signalling Indicator</b></p> <p>This information element contains the MBMS In-band Signalling Indicator. This information element is defined in sub-clause 12.45.</p>
<p><b>PBCCH information</b></p> <p>This information, if present, describes the PBCCH location in the target cell. In case PBCCH is allocated in the target cell and can be described with this encoding, this information shall be included in the message.</p>
<p><b>USF</b> (3 bit field)</p> <p>This field identifies the USF value that identifies the MPRACH defined on the uplink feedback channel in the neighbour cell.</p> <p>The list of MBMS bearers in the Rel-7 additions is ordered as described by the loops in the earlier releases part. The choice bit indicates for each MBMS bearer whether the parameters are present or not.</p>
<p><b>MPRACH Control Parameters</b></p> <p>This information element, if present, defines the access control parameters to be used on the MPRACH defined on the uplink feedback channel in the neighbour cell. This information element is defined in sub-clause 12.41.</p>
<p><b>NPM Transfer Time</b> (5 bit field)</p> <p>This field is defined in sub-clause 12.45a.</p>

## 11.2.41 MBMS MS\_ID Assignment

This message is sent on the PACCH by the network to the mobile station to assign an MS\_ID and to provide the timing advance parameters to the mobile station in case of an MBMS radio bearer with an assigned uplink feedback channel. The message can also be used to reassign or delete the MS\_ID assigned to the mobile station.

Message type: MBMS MS\_ID ASSIGNMENT

Direction: network to mobile station

Classification: non-distribution message

**Table 11.2.41.1: MBMS MS\_ID ASSIGNMENT information elements**

```

< MBMS MS_ID Assignment message content > ::=
  < PAGE_MODE : bit (2) >
  {
    { 0 < Global TFI : < Global TFI IE > >
      | 10 < TLLI / G-RNTI : bit (32) > }
    { 0
      -- MS_ID is assigned the first time.
      < Length of MBMS Bearer Identity : bit (3) >
      < MBMS Bearer Identity : bit (val (Length of MBMS Bearer Identity)) >
      < MS_ID : bit (5 - val (Length of MBMS Bearer Identity)) >
      < Packet Timing Advance : < Packet Timing Advance IE > >
      { 0 | 1 < ALPHA : bit (4) >
        { 0 | 1 < GAMMA : bit (5) > }
      }
    }
    | 1
      -- MS_ID is reassigned.
      < Current MS_ID Expiry Time : bit (16) >
      { 0
        -- MS_ID is not redefined.
      | 1
        -- MS_ID is redefined.
        < Length Indicator of MS_ID : bit (2) >
        < MS_ID : bit (val (Length Indicator of MS_ID) + 1) > }
      { 0 | 1 < Packet Timing Advance : < Packet Timing Advance IE > >
        { 0 | 1 < ALPHA : bit (4) >
          { 0 | 1 < GAMMA : bit (5) > }
        }
      }
      < padding bits >
      ! < Non-distribution part error : bit (*) = < no string > > }
      ! < Address information part error : bit (*) = < no string > > }
      ! < Distribution part error : bit (*) = < no string > > ;
  
```

**Table 11.2.41.2: MBMS MS\_ID ASSIGNMENT information element details**

<b>PAGE_MODE</b> (2 bit field)
This field is defined in sub-clause 12.20.
<b>Global TFI</b>
This information element shall always contain the DOWNLINK_TFI field. The most significant bit(s) of the DOWNLINK_TFI field denote(s) the MBMS Bearer Identity of the MBMS radio bearer the message relates to and the remaining least significant bit(s) denote(s) the MS_ID addressing the mobile station the message relates to. This field is defined in sub-clause 12.10.
<b>TLLI / G-RNTI</b> (32 bit field)
This field contains the TLLI/G-RNTI of the mobile station. This field is encoded as defined in sub-clause 12.16.
<b>MBMS Bearer Identity</b> (1-5 bit field)
This field identifies the MBMS radio bearer this message relates to and is defined in sub-clause 12.34.
<b>MS_ID</b> (1-4 bit field)
This field assigns an identifier to the mobile station, identified by the TLLI, on the MBMS radio bearer identified by the MBMS Bearer Identity, and can also be used to reassign the identifier assigned to the mobile station. This field is defined in sub-clause 12.35.

<p><b>Packet Timing Advance</b> This information element is defined in sub-clause 12.12.</p>
<p><b>ALPHA</b> (4 bit field) For encoding and description see the Global Power Control Parameters IE.</p>
<p><b>GAMMA</b> (5 bit field) The GAMMA field is the binary representation of the parameter <math>\Gamma_{CH}</math> for MS output power control in units of 2 dB, see 3GPP TS 45.008. The GAMMA field is coded according to the following table:</p> <pre> bit 5 4 3 2 1 0 0 0 0 0  <math>\Gamma_{CH} = 0</math> dB 0 0 0 0 1  <math>\Gamma_{CH} = 2</math> dB ::: 1 1 1 1 0  <math>\Gamma_{CH} = 60</math> dB 1 1 1 1 1  <math>\Gamma_{CH} = 62</math> dB </pre>
<p><b>Current MS_ID Expiry Time</b> This field contains an expiry time that indicates the frame number during which the mobile station shall consider the current MS_ID as released and, if a new MS_ID is assigned, the new MS_ID as valid. This information element is encoded as the value part of the <i>Starting Time</i> information element specified in 3GPP TS 44.018.</p>

## 11.2.42 Packet MBMS Announcement

This message is sent on PACCH by the network to notify all MBMS mobile stations listening to that PDCH that an MBMS Service Session is commencing or an ongoing MBMS Broadcast Service Session with an updated MBMS service area list is available.

Message type: PACKET MBMS ANNOUNCEMENT

Direction: network to mobile station

Classification: distribution message

Table 11.2.42.1: PACKET MBMS ANNOUNCEMENT information elements

<pre> &lt; PACKET MBMS ANNOUNCEMENT message content &gt; ::=   &lt; PAGE_MODE : bit (2) &gt;   &lt; TMGI : &lt; TMGI IE &gt; &gt;   { 0   1 &lt; MBMS Session Identity : bit (8) &gt; }     { 0       -- counting is off       { 0   1 &lt; MBMS p-t-m channel description : &lt; MBMS p-t-m channel description struct &gt; &gt; }       1       -- counting is on       { 0   1 &lt; MPRACH description : &lt; MPRACH description struct &gt; &gt; }     }   { 0   1 &lt; RESTRICTION_TIMER : bit (4) &gt; }   &lt; padding bits &gt; // -- truncation at end of message allowed, bits '0' assumed   ! &lt; Distribution part error : bit (*) = &lt; no string &gt; &gt; ; </pre>
<pre> &lt; MBMS p-t-m channel description struct &gt; ::=   &lt; Estimated Session Duration : bit (8) &gt;   { 0   1 &lt; MBMS Radio Bearer Starting Time : bit (16) &gt; }   { 0   1 &lt; Frequency Parameters : &lt; Frequency Parameters IE &gt; &gt; }   &lt; DL_TIMESLOT_ALLOCATION : bit (8) &gt;   &lt; Length of MBMS Bearer Identity : bit (3) &gt;   &lt; MBMS Bearer Identity : bit (val (Length of MBMS Bearer Identity)) &gt;   { 0   1 &lt; EGPRS Window Size : &lt; EGPRS Window Size IE &gt;&gt; }   { 0   1 &lt; NPM Transfer Time : bit (5) &gt; }; </pre>
<pre> &lt; MPRACH description struct &gt; ::=   { 0   1 &lt; Frequency Parameters : &lt; Frequency Parameters IE &gt; &gt; }   &lt; MPRACH_TIMESLOT : bit (3) &gt;   &lt; USF : bit (3) &gt;   { 0     -- no MPRACH access parameters present     1     -- MPRACH access parameters present   }   &lt; MPRACH Control Parameters : &lt; MPRACH Control Parameters IE &gt; &gt; }; </pre>

Table 11.2.42.2: PACKET MBMS ANNOUNCEMENT information element details

<p><b>PAGE_MODE</b> (2 bit field) This field is defined in sub-clause 12.20.</p>
<p><b>TMGI IE</b> This field contains the Temporary Mobile Group Identity of the MBMS service that the MBMS Notification concerns. This field is encoded as defined in sub-clause 12.33.</p>
<p><b>MBMS Session Identity</b> (8 bit field) This field contains the MBMS Session Identity of the concerned MBMS session (see TS 23.003).</p>
<p><b>Estimated Session Duration</b> (8 bit field) This field contains an estimation of the session (remaining) duration for the concerned MBMS session. This information element is defined in sub-clause 12.44.</p>
<p><b>MBMS Radio Bearer Starting Time</b> (16 bit field) This field contains a starting time that indicates the frame number from which the data transfer on the assigned MBMS radio bearer may start. The MBMS Radio Bearer Starting Time is encoded as the value part of the type 3 information element <i>Starting Time</i> in 3GPP TS 44.018.</p>
<p><b>Frequency Parameters</b> If this information element is not present, the same frequency as for the PCCCH shall be used. This information element is defined in sub-clause 12.8.</p>
<p><b>DL_TIMESLOT_ALLOCATION</b> (8 bit field) This field is defined in sub-clause 12.18.</p>

<p><b>MBMS Bearer Identity</b> (1-5 bit field)</p> <p>This field assigns a TFI value, or a subset of a TFI value, which identifies the MBMS radio bearer that is described. In case only a subset of a TFI value is assigned for the MBMS radio bearer, that subset corresponds to the most significant bit(s) of the TFI field.</p>																
<p><b>EGPRS Window Size</b></p> <p>This information element is defined in sub-clause 12.5.2.</p>																
<p><b>MPRACH_TIMESLOT</b> (3 bit field)</p> <p>This field identifies the timeslot number of the PDCH where the MPRACH is located.</p>																
<p><b>USF</b> (3 bit field)</p> <p>This field identifies the USF value that identifies the MPRACH on the defined PDCH.</p>																
<p><b>MPRACH Control Parameters</b></p> <p>This information element, if present, defines the access control parameters to be used on the MPRACH. This information element is defined in sub-clause 12.41.</p>																
<p><b>RESTRICTION_TIMER</b></p> <p>This field indicates the maximum reaction time to the PACKET MBMS ANNOUNCEMENT message in seconds for mobile station, before the information contained in the PACKET MBMS ANNOUNCEMENT message expires.</p> <table> <tr> <td>Bit</td> <td></td> </tr> <tr> <td>4 3 2 1</td> <td></td> </tr> <tr> <td>0 0 0 0</td> <td>10</td> </tr> <tr> <td>0 0 0 1</td> <td>20</td> </tr> <tr> <td>0 0 1 0</td> <td>30</td> </tr> <tr> <td></td> <td>...</td> </tr> <tr> <td>1 1 1 0</td> <td>150</td> </tr> <tr> <td>1 1 1 1</td> <td>160</td> </tr> </table>	Bit		4 3 2 1		0 0 0 0	10	0 0 0 1	20	0 0 1 0	30		...	1 1 1 0	150	1 1 1 1	160
Bit																
4 3 2 1																
0 0 0 0	10															
0 0 0 1	20															
0 0 1 0	30															
	...															
1 1 1 0	150															
1 1 1 1	160															
<p><b>NPM Transfer Time</b> (5 bit field)</p> <p>This field is defined in sub-clause 12.45a.</p>																

### 11.2.43 PS Handover Command

This message is sent on the PACCH by the network to the mobile station to command the mobile station to leave the current cell and change to a new cell. The mobile station shall acknowledge this message according to sub-clause 8.10.4. This message can be sent using Extended RLC/MAC control segmentation (see sub-clause 9.1.12a). The combined length of the IEs included in the PS HANDOVER COMMAND message shall not exceed 175 octets.

If the network allocates PS resources on a single carrier where those resources are not required to support any of the features EGPRS2, Fast Ack/Nack Reporting or RTTI configurations, then the network shall include the PS Handover Radio Resources Info IE in the PS HANDOVER COMMAND message. Otherwise, the network shall include the PS Handover Radio Resources 2 Info IE or the PS Handover Radio Resources 3 IE the PS HANDOVER COMMAND message.

Message type: PS HANDOVER COMMAND

Direction: network to mobile station

Classification: non-distribution message

Table 11.2.43.1: PS HANDOVER COMMAND information elements

```

< PS Handover Command message content > ::=
  < PAGE_MODE : bit (2) >
  { 0 < Global TFI : < Global TFI IE > >
    { -- Non-distribution part
      < CONTAINER_ID : bit(2) >
      { 00 < PS Handover to A/Gb Mode Payload :
          { 00 < PS Handover RR Info: < PS Handover Radio Resources IE > >
            | 01 < PS Handover RR 2 Info: < PS Handover Radio Resources 2 IE > >
            | 10 < PS Handover RR 3 Info: < PS Handover Radio Resources 3 IE > >
            ! < RR Handover RR Info Error : { 11 } bit (*) = <no string> > } - Extended for future changes
          { 0 | 1 < NAS Container for PS Handover IE > }
        | 01 < PS Handover to UTRAN Payload :
            < RRC Container IE > >
        | 10 < PS Handover to E-UTRAN Payload :
            < RRC Container IE > >
        ! < Message escape : 11 bit (*) = < no string > > } -- Extended for future changes
      { null | 0 bit ** = < no string > -- Receiver compatible with earlier release
        | 1 -- Additions in Rel-8 :
          { 0 | 1 < E-UTRAN_CCN_ACTIVE : bit (1) > }
          { 0 | 1 < Measurement Control Parameters Description :
              < MeasurementControl Parameters Description IE>>}
          { null | 0 bit** = < no string > -- Receiver backward compatible with earlier version
            | 1 -- Additions for Rel-9
              < Enhanced Flexible Timeslot Assignment : bit >
              { 0 < EMST_NW_Capability : bit (1) > -- EMST is not used
                | 1 -- EMST is used
                  { 0
                    | 1 < Downlink RLC Entity 2 : < RLC Entity Struct >
                      { 0
                        | 1 < Downlink RLC Entity 3 : < RLC Entity Struct > }
                      }
                    { 0
                    | 1 < Uplink RLC Entity 2 : < RLC Entity Struct >
                      { 0
                        | 1 < Uplink RLC Entity 3 : < RLC Entity Struct > }
                      }
                    }
                  }
              { null | 0 bit** = < no string > -- Receiver backward compatible with earlier version
                | 1 -- Additions for Rel-10
                  { 0 -- EMSR is not enabled in downlink
                    | 1 -- EMSR is enabled in downlink
                      { 1 < EMSR Additional PFCs 1 : < Additional PFCs struct > > } ** 0
                      { 1 < EMSR Additional PFCs 2 : < Additional PFCs struct > > } ** 0
                      { 1 < EMSR Additional PFCs 3 : < Additional PFCs struct > > } ** 0
                    }
                  { 0 -- EMSR is not enabled in uplink
                    | 1 -- EMSR is enabled in uplink
                      { 1 < EMSR Additional PFCs 1 : < Additional PFCs struct > > } ** 0
                      { 1 < EMSR Additional PFCs 2 : < Additional PFCs struct > > } ** 0
                      { 1 < EMSR Additional PFCs 3 : < Additional PFCs struct > > } ** 0
                    }
                  }
              { null | 0 bit** = < no string > -- Receiver backward compatible with earlier version
                | 1 -- Additions for Rel-11
                  { 0 | 1 < Selected PLMN Index : bit(3) > }
                  { null | 0 bit** = < no string > -- Receiver backward compatible with earlier version
                    | 1 -- Additions for Rel-12
                      < Primary TSC Set : bit (1) >
                      { 0 | 1 -- Secondary DL TSC Value assigned
                        < Secondary DL TSC Set : bit (1) >
                        < Secondary DL TSC Value : bit (3) > }
                      }
                }
            }
          }
        }
      }
    }
  }
  ! < Non-distribution part error : bit (*) = < no string > > }
  ! < Address information part error : bit (*) = < no string > > }
  ! < Distribution part error : bit (*) = < no string > > ;

```

```

< RLC Entity Struct > ::=
  < TFI : bit (5) >
  < RLC_MODE : bit (1) >
  { 0 | 1 < EGPRS Window Size : < EGPRS Window Size IE > > }
  < PFI : bit (7) >;

< Additional PFCs struct > ::=
  < TFI : bit (5) >
  { 0 | 1 < NPM Transfer Time : bit (5) > }
  < PFI : bit (7) >;

```

**Table 11.2.43.2: PS HANDOVER COMMAND information element details**

<p><b>PAGE_MODE</b> (2 bit field) This field is defined in sub-clause 12.20.</p>
<p><b>Global TFI</b> This information element contains the TFI of the mobile station's downlink TBF or uplink TBF. This field is defined in sub-clause 12.10.</p>
<p><b>CONTAINER_ID</b> (2 bit field) This field contains the identity of the neighbour cell system information container previously sent in the PACKET NEIGHBOUR CELL DATA messages (see sub-clause 8.10.2). This field is ignored by the mobile station except in the case of PS Handover from GERAN A/Gb mode or GERAN Iu mode to GERAN A/Gb or GERAN Iu mode.  Range 0 to 3.</p>
<p><b>PS Handover to A/Gb Mode Payload</b> This information element contains the information needed by the mobile station when performing PS Handover to <i>A/Gb mode</i>. It consists of the <i>PS Handover Radio Resources IE</i> (see sub-clause 12.42) or the <i>PS Handover Radio Resources 2 IE</i> (see sub-clause 12.42a) or the <i>PS Handover Radio Resources 3 IE</i> (see sub-clause 12.42b) and optionally the <i>NAS Container for PS Handover IE</i> (see sub-clause 12.43).</p>
<p><b>PS Handover to UTRAN Payload</b> This information element contains a HANDOVER TO UTRAN COMMAND message (as defined in 3GPP TS 25.331) containing the information needed by the mobile station when performing PS Handover to UTRAN. This information element is defined in sub-clause 12.45b.</p>
<p><b>PS Handover to E-UTRAN Payload</b> This information element contains a <i>DL-DCCH-Message</i> including a <i>RRCCOnnectionReconfiguration</i> message (as defined in 3GPP TS 36.331) containing the information needed by the mobile station when performing PS Handover to E-UTRAN. This information element is defined in sub-clause 12.45b.</p>
<p><b>E-UTRAN_CCN_ACTIVE</b> (1 bit field) This field indicates whether CCN is enabled towards E-UTRAN neighbouring cells in the target cell. For description and encoding see subclause 12.53. This field shall be included only if the PS Handover to A/Gb Mode Payload structure is included.</p>
<p><b>Enhanced Flexible Timeslot Assignment</b> (1 bit field) This field is defined in sub-clause 11.2.29.</p>
<p><b>Measurement Control Parameters Description</b>  This information element contains the Measurement control parameters per frequency for UTRAN and E-UTRAN for the target cell. This information element is defined in sub-clause 12.56. This field shall be included only if the PS Handover to A/Gb Mode Payload structure is included.</p>
<p><b>EMST_NW_Capability</b> (1 bit field) This information element is defined in sub-clause 11.2.29.</p>
<p><b>PFI</b> (7 bit field) This information element is defined in sub-clause 11.2.31.</p>

<b>TFI</b> (5 bit field) This information element is defined in sub-clause 11.2.31.
<b>RLC_MODE</b> (1 bit field) This information element is defined in sub-clause 11.2.31.
<b>NPM Transfer Time</b> (5 bit field)
<b>EMSR Additional PFCs 1</b> <b>EMSR Additional PFCs 2</b> <b>EMSR Additional PFCs 3</b> These IEs are defined in section 11.2.7. If the PS HANDOVER COMMAND message includes the PS Handover Radio Resources 3 IE then these information elements shall be ignored (if included).
<b>Selected PLMN Index</b> (3 bit field) This field is defined in sub-clause 10.4.27
<b>PS Handover RR 3 Info</b> This information is included when performing a PS handover that results in a DLMC configuration (see sub-clause 12.4.2b).
<b>Primary TSC Set</b> (1 bit field) See sub-clause 11.2.7 and 11.2.29.
<b>Secondary DL TSC Set</b> (1 bit field) See sub-clause 11.2.7.
<b>Secondary DL TSC Value</b> (3 bit field) See sub-clause 11.2.7.

## 11.2.44 PS Handover Access

This message is sent by the mobile station to the network to make the network aware that the mobile station has left the old cell and arrived in the new cell. The message is sent four times using either the 8-bit or 11-bit access burst format on the PACCH associated with an uplink TBF allocated in the PS Handover Command message as described in sub-clause 8.10.4. The mobile station shall use the format indicated by the System Information parameter ACCESS\_BURST\_TYPE applicable to the target cell. Each message is coded as shown in table 11.2.42.1. The order of bit transmission is defined in 3GPP TS 44.004. The numbering, assembling and field mapping conventions defined for RLC/MAC control blocks in sub-clause 10.0b shall apply.

Message type: PS HANDOVER ACCESS

Direction: mobile station to network

**Table 11.2.44.1: PS HANDOVER ACCESS information elements**

< PS Handover Access message content 8 bit message > ::= -- 8-bit access burst format < <b>Handover Reference</b> : bit (8) >;
< PS Handover Access message content 11 bit message > ::= -- 11-bit access burst format < <b>Handover Reference</b> : bit (8) > < <b>spare</b> : bit (3) >;



**Table 11.2.44.2 : PS HANDOVER ACCESS information element details**

<b>Handover Reference</b> (8 bit field) This information field identifies the mobile station in the new cell. The semantics of this field is defined in 3GPP TS 44.018.
<b>spare</b> (3 bit field) These bits are reserved for future use and shall be set to '000' in this release.

### 11.2.45 Packet Physical Information (*A/Gb mode only*)

This message is sent on PACCH by the network to the mobile station during a handover procedure as specified in sub-clause 8.10 to indicate a valid timing advance to the mobile station.

Message type: PACKET PHYSICAL INFORMATION

Direction: network to mobile station

Classification: non-distribution message

**Table 11.2.45.1: PACKET PHYSICAL INFORMATION information elements**

< Packet Physical information message content > ::= -- RLC/MAC control block format < <b>PAGE_MODE</b> : bit (2) > < <b>Global TFI</b> : < Global TFI IE > > < <b>TIMING_ADVANCE_VALUE</b> : bit (8) > < padding bits >;	-- truncation at end of message allowed, bits '0' assumed
--	---

**Table 11.2.45.2: PACKET PHYSICAL INFORMATION information element details**

<b>PAGE_MODE</b> (2 bit field) This field is defined in sub-clause 12.20.
<b>Global TFI</b> This information element contains the TFI of the mobile station's downlink TBF or uplink TBF. This field is defined in sub-clause 12.10.
<b>TIMING_ADVANCE_VALUE</b> (8 bit field) This field is coded as the timing advance value field defined in 3GPP TS 44.018.

### 11.2.46 DTM Handover Command

This message is sent on the PACCH by the network to the mobile station in dual transfer mode to command the mobile station to leave the current cell and change to a new cell. This message may be sent using Extended RLC/MAC control segmentation (see sub-clause 9.1.12a). The combined length of the IEs included in the DTM HANDOVER COMMAND message shall not exceed 175 octets.

If the network allocates PS resources on a single carrier where those resources are not required to support any of the features EGPRS2, Fast Ack/Nack Reporting or RTTI configurations, then the network shall include the DTM Handover PS Radio Resources IE in the DTM HANDOVER COMMAND message. Otherwise, the network shall include the DTM Handover PS Radio Resources 2 IE or DTM Handover PS Radio Resources 3 IE in the DTM HANDOVER COMMAND message.

Message type: DTM HANDOVER COMMAND

Direction: network to mobile station

Classification: non-distribution message

Table 11.2.46.1: DTM HANDOVER COMMAND information elements

```

< DTM Handover Command message content > ::=
  < PAGE_MODE : bit (2) >
  { 0 < Global TFI : < Global TFI IE > >
    { -- Non-distribution part
      { 00 < DTM Handover to A/Gb Mode Payload :
          < DTM Handover to A/Gb mode Payload description struct > >
        | 01 < DTM Handover to UTRAN Payload : < RRC Container IE > >
        ! < Message escape : { 10 | 11 } bit (*) = < no string > > } -- Extended for future changes
        < padding bits >
        ! < Non-distribution part error : bit (*) = < no string > > }
      ! < Address information part error : bit (*) = < no string > > }
    ! < Non-distribution part error : bit (*) = < no string > > ;

< DTM Handover to A/Gb mode Payload description struct > ::=
  < DTM Handover CS RR Info: < DTM Handover CS Radio Resources IE > >
  { 00 < DTM Handover PS RR Info: < DTM Handover PS Radio Resources IE > >
    | 01 < DTM Handover PS RR 2 Info : < DTM Handover PS Radio Resources 2 IE > >
    | 10 < DTM Handover PS RR 3 Info : < DTM Handover PS Radio Resources 3 IE > >
    ! < Message escape : { 11 } bit (*) = < no string > > } -- reserved for future use
  { 0 | 1 < NAS Container for PS Handover IE > };

```

Table 11.2.46.2: DTM HANDOVER COMMAND information element details

<b>PAGE_MODE</b> (2 bit field) This field is defined in sub-clause 12.20.
<b>Global TFI</b> This information element contains the TFI of the mobile station's downlink TBF or uplink TBF. This field is defined in sub-clause 12.10.
<b>DTM Handover CS Radio Resources</b> This information element contains the CS information needed by the mobile station when performing DTM Handover to <i>A/Gb mode</i> and is defined in sub-clause 12.47. If a mobile station supports extended TSC sets (see 3GPP TS 45.002 [32]) then TSC related information applicable to the PS domain identified by the <i>DTM Handover PS RR Info</i> IE, the <i>DTM Handover PS RR 2 Info</i> IE or the <i>DTM Handover PS RR 3 Info</i> IE shall take precedence over TSC related information applicable to the PS domain provided by this IE.
<b>DTM Handover PS RR Info</b> This information element contains the PS information needed by the mobile station when performing DTM Handover to <i>A/Gb mode</i> and is defined in sub-clause 12.46. If a mobile station supports extended TSC sets (see 3GPP TS 45.002 [32]) then this IE can be used to identify TSC related information applicable to the PS domain.
<b>DTM Handover PS RR 2 Info</b> This information element contains the PS information needed by the mobile station when performing DTM Handover to <i>A/Gb mode</i> when downlink PS resources are assigned on two carriers or requires the support of EGPRS2, Fast Ack/Nack Reporting or RTTI configurations, and is defined in sub-clause 12.48. If a mobile station supports extended TSC sets (see 3GPP TS 45.002 [32]) then this IE can be used to identify TSC related information applicable to the PS domain.
<b>DTM Handover PS RR 3 Info</b> This information element contains the PS information needed by the mobile station and can only be used when EMSR or extended TSC sets (see 3GPP TS 45.002 [32]) is supported by the mobile station. This information element is defined in sub-clause 12.64. If a mobile station supports extended TSC sets (see 3GPP TS 45.002 [32]) then this IE can be used to identify TSC related information applicable to the PS domain.
<b>NAS Container for PS Handover</b> This information element contains the NAS information needed by the mobile station when performing DTM Handover to <i>A/Gb mode</i> and is defined in sub-clause 12.43.

**DTM Handover to UTRAN Payload**

This information element contains a HANDOVER TO UTRAN COMMAND message (as defined in 3GPP TS 25.331) containing the information needed by the mobile station when performing DTM Handover to UTRAN. This information element is defined in sub-clause 12.45b.

## 11.2.47 Packet Application Information

This message is sent on the PACCH by the network to convey an embedded Application, e.g. an ETWS Primary Notification message (see 3GPP TS 23.041), between the network and the mobile station(s). This message may be segmented across more than two RLC/MAC control blocks by using extended RLC/MAC control message segmentation.

Message type: PACKET APPLICATION INFORMATION

Direction: network to mobile station

Classification: distribution message

**Table 11.2.47.1: PACKET APPLICATION INFORMATION information elements**

```
< Packet Application Information message content > ::=
  < PAGE_MODE : bit (2) >
  {
    < Application Type : bit (4) > -- type of Application
    < Application Data : octet ** >
    < padding bits >
  }
  ! < Distribution part error : bit (*) = < no string > >;
```

**Table 11.2.47.2: PACKET APPLICATION INFORMATION information element details**

<b>PAGE_MODE</b> (2 bit field) This field is defined in sub-clause 12.20.
<b>Application Type</b> (4 bit field) This field identifies the particular protocol and associated application for the Application data.
Bit 4 3 2 1 0 0 0 0 ETWS (3GPP TS 23.041) 0 0 0 1 reserved for future use to 1 1 1 1 reserved for future use
<b>Application Data</b> (n*8 bits) The Application Data contains the data of following Application Types:
ETWS The ETWS data forms the actual ETWS Primary Notification message. The ETWS Primary Notification data is coded as specified in 3GPP TS 23.041.

## 11.2.48 EGPRS Packet Downlink Ack/Nack DLMC

This message is sent on the PACCH from the mobile station to the network to indicate the status of downlink RLC data blocks received and to report the channel quality of the downlink for a DLMC configuration.

Message type: EGPRS Packet Downlink Ack/Nack DLMC

Direction: mobile station to network

**Table 11.2.48.1: EGPRS PACKET DOWNLINK ACK/NACK DLMC information elements**

<pre> &lt; EGPRS Packet Downlink Ack/Nack DLMC message content &gt; ::=   &lt; DOWNLINK_TFI : bit (5) &gt;   &lt; DOWNLINK_eTFI : bit (3) &gt;   &lt; MS OUT OF MEMORY : bit(1)&gt;   { 0   1 &lt; DLMC Channel Quality Report &gt; }   { 0   1 &lt; Channel Request Description &gt; }   { 0   1 &lt; PFI : bit(7) &gt; }   { 0   1 &lt; EGPRS Ack/Nack Description DLMC &gt;     { 0   1 &lt; DLMC Channel Quality Report &gt; } }   &lt;padding bits &gt; ; </pre>
---

**Table 11.2.48.2: EGPRS PACKET DOWNLINK ACK/NACK DLMC information element details**

<p><b>DOWNLINK_TFI</b> (5 bit field) This field contains the TFI of the mobile station's downlink TBF. This field is defined in sub-clause 12.15.</p>
<p><b>DOWNLINK_eTFI</b> (3 bit field) This field contains the eTFI of the mobile station's downlink TBF. A mobile station not assigned an eTFI shall set this field to "000".</p>
<p><b>MS OUT OF MEMORY</b> (1 bit field) This field indicates that the MS has no more enough memory to perform Incremental Redundancy.</p> <p>0 The MS has enough memory 1 The MS is running out of memory</p>
<p><b>DLMC Channel Quality Report</b> This information element is defined in sub-clause 12.66. This IE shall be used by a mobile station with a DLMC configuration and contains measurements corresponding to the set of reported UFPS/carriers (see sub-clause 9.1.8.2.1 for how the set of UFPS/carriers to report is determined).</p>
<p><b>Channel Request Description</b> This information element is defined in sub-clause 12.7. If a PFI field is included in this message, it relates to the TBF request contained in the <i>Channel Request Description</i> IE.</p>
<p><b>PFI</b> (7 bit field) This field contains the PFI parameter identifying a Packet Flow Context relating to the resource request specified in the <i>Channel Request Description</i> IE. The PFI parameter is encoded as the contents of the PFI information element as defined in 3GPP TS 44.018. This field may be included if the network supports packet flow context procedures and if a Channel Request Description IE is included in the message. If this field is included but the <i>Channel Request Description</i> IE is omitted, this field shall be ignored.</p>
<p><b>EGPRS Ack/Nack Description DLMC</b> (L bit field) This information element is defined in sub-clause 12.3.3. The number of bits (L) available for this information element depends on the inclusion of channel quality reports and channel requests. L shall be set so that the entire EGPRS PACKET DOWNLINK ACK/NACK DLMC message evenly fits into an RLC/MAC control block. If a lower L covers the entire receive window, that L shall be used.</p> <p>Truncation of the EGPRS Ack/Nack Description DLMC IE is allowed if the available space in the message without this IE does not allow for the inclusion of a valid EGPRS Ack/Nack Description DLMC IE, i.e. is less than 16 bits of message space remains. In these conditions, the receiver shall assume that no EGPRS Ack/Nack Description DLMC IE is included.</p>

## 12 Information element coding

### 12.1 Overview

Information elements used within the context of only one RLC/MAC control message are defined in clause 11. All other information elements are defined within the present sub-clause.

### 12.2 (void)

### 12.3 Ack/Nack Description

The Ack/Nack Description information element contains the RLC parameters used to acknowledge or negatively acknowledge a group of RLC data blocks.

**Table 12.3.1: Ack/Nack Description information elements**

<pre> &lt; Ack/Nack Description IE &gt; ::=   &lt; FINAL_ACK_INDICATION : bit (1) &gt;   &lt; STARTING_SEQUENCE_NUMBER : bit (7) &gt;   &lt; RECEIVED_BLOCK_BITMAP : bit (64) &gt; ; </pre>
---

**Table 12.3.2: Ack/Nack Description information element details**

<p><b>FINAL_ACK_INDICATION</b> (1 bit field)</p> <p>This field indicates whether the entire TBF is being acknowledged. If, in case the uplink TBF is operating in non-extended uplink TBF mode, the entire TBF is being acknowledged, the SSN and RBB fields contain no information and shall be ignored. When acknowledging the entire TBF in extended uplink TBF mode the SSN and RBB fields shall be interpreted.</p> <p>0 retransmission are requested and the TBF is incomplete  1 no retransmissions are requested and this message indicates acknowledgement of all RLC data in the TBF</p>
<p><b>STARTING_SEQUENCE_NUMBER (SSN)</b> (7 bit field)</p> <p>The SSN contains the value of V(R) when this information element was transmitted. This field is encoded as the binary representation of V(R).  Range 0 to 127</p>
<p><b>RECEIVE_BLOCK_BITMAP (RBB)</b> (64 bit field)</p> <p>The RBB is a bitmap representing Block Sequence Numbers. The bitmap is indexed relative to SSN as follows:</p> $\text{BSN} = (\text{SSN} - \text{bit\_number}) \text{ modulo } 128, \quad \text{for bit\_number} = 1 \text{ to } 64.$ <p>The BSN values represented range from (SSN - 1) mod 128 to (SSN - 64) mod 128.</p> <p>The value of each bit is encoded as:</p> <p>0 Negative acknowledgement of the RLC data block with BSN = (SSN - bit_number) mod 128  1 Positive acknowledgement of the RLC data block with BSN = (SSN - bit_number) mod 128</p> <p>Mapping of the bitmap is defined on sub-clause 11.</p>

#### 12.3.1 EGPRS Ack/Nack Description

The Ack/Nack Description information element contains the RLC parameters used to acknowledge or negatively acknowledge a group of RLC data blocks. The number of bits available for the bitmap depends on the inclusion or exclusion of other information elements in the used message.

Table 12.3.1.1: EGPRS Ack/Nack Description information elements

<pre> &lt; EGPRS Ack/Nack Description IE &gt; ::=   0 &lt; EGPRS Ack/Nack Description struct &gt;  -- This IE fills rest of message     1 &lt; Length L : bit (8) &gt;                -- Value part of this IE is of length L     { &lt; bit (val(Length L)) &gt; &amp; &lt; EGPRS Ack/Nack Description struct &gt; };  &lt; EGPRS Ack/Nack Description struct &gt; ::=   &lt; FINAL_ACK_INDICATION : bit (1) &gt;   &lt; BEGINNING_OF_WINDOW : bit (1) &gt;   &lt; END_OF_WINDOW : bit (1) &gt;   &lt; STARTING_SEQUENCE_NUMBER : bit (11) &gt;   { 0   1 &lt; COMPRESSED_BITMAP_LENGTH: bit (7) &gt;     &lt; COMPRESSED_BITMAP_STARTING_COLOR_CODE: bit (1) &gt;     &lt; COMPRESSED_RECEIVED_BLOCK_BITMAP :       bit (val(COMPRESSED_BITMAP_LENGTH)) &gt; }   &lt; UNCOMPRESSED_RECEIVED_BLOCK_BITMAP: bit** &gt; ; </pre>
---

Table 12.3.1.2: EGPRS Ack/Nack Description information element details

<p><b>LENGTH L</b> (8 bit field) Range 15 to 255 This field represents the length of the value part (i.e. the EGPRS Ack/Nack Description struct) of this information element. If this field is not included, this information element fills the remaining part of the message.</p>
<p><b>FINAL_ACK_INDICATION</b> (1 bit field) This field indicates whether the entire TBF is being acknowledged. If, in case the uplink TBF is operating in non-extended uplink TBF mode, the entire TBF is being acknowledged, the SSN, CRBB and URBB fields contain no information and shall be ignored. When acknowledging the entire TBF in extended uplink TBF mode, the SSN, CRBB and URBB fields shall be interpreted if present.</p> <p>0 retransmissions are requested and the TBF is incomplete. 1 no retransmissions are requested and this message indicates acknowledgement of all RLC data in the TBF.</p>
<p><b>BEGINNING_OF_WINDOW</b> (BOW, 1 bit field) This bit indicates if the Ack/Nack bitmap starts at the beginning of the window.</p> <p>0 SSN not equal to <math>(V(Q)+1) \bmod 2048</math>. 1 <math>SSN = (V(Q) + 1) \bmod 2048</math></p>
<p><b>END_OF_WINDOW</b> (EOW, 1 bit field) This bit indicates if the end of the receiver window is included in the bitmap(s).</p> <p>0 <math>[V(R) - 1] \bmod SNS</math> is not included in the bitmap. 1 <math>[V(R) - 1] \bmod SNS</math> is included in the bitmap.</p>
<p><b>STARTING_SEQUENCE_NUMBER</b> (SSN) (11 bit field) Range 0 to 2047 The SSN indicates the Block Sequence Number of the first RLC block for which the Ack/Nack receipt status is indicated within the bitmap. The SSN is determined using S/P, PBSN and <math>V(Q)</math>.</p>
<p><b>COMPRESSED_BITMAP_LENGTH</b> (Lc) (7 bit field) Range 0 to 127 This field represents the length of the compressed bitmap. Compression is carried out using T.4 run length coding.</p>
<p><b>COMPRESSED_BITMAP_STARTING_COLOR_CODE</b> (1 bit field) This bit indicates if the first code word in the compressed bitmap (i.e. CRBB) represents a run length of ones or a run length of zeros.</p> <p>0 First code word in CRBB represents run length of zeros. 1 First code word in CRBB represents run length of ones.</p>

**COMPRESSED\_RECEIVE\_BLOCK\_BITMAP (CRBB)** (Lc bit field)

The CRBB is a compressed bitmap. Compression is carried out starting at SSN using modified T.4 run length coding. The number of bits (Lc) available for Ack/Nack Description depends on the inclusion of other information elements in the used message.

The packing order of the CRBB shall be such that the codeword (or pair of make up/terminating codewords) corresponding to the run including the SSN starts at the most significant bit of the CRBB, and codewords (or pairs of make-up/terminating codewords) corresponding to runs including higher and successively increasing sequence numbers are placed in bits of successively decreasing significance.

NOTE: The URBB is packed in the opposite order.

**UNCOMPRESSED\_RECEIVE\_BLOCK\_BITMAP (URBB)** (Lu bit field)

The URBB is an uncompressed bitmap, which fills the remainder of this information element upto L bits, where L is the number of bits available for the EGPRS Ack/Nack description struct. The URBB field length, Lu, is determined by:

Lu = L-Lc-23, when the compressed received block bitmap is included, or by

Lu = L-15, when the compressed received block bitmap is not included:

The bits in URBB, denoted here by index i, are numbered from i=1 (lowest order value) to i=Lu (highest order value). The value of each bit in the bitmap is encoded as following:

- 0 Negative acknowledgement of the RLC data block with BSN = (ESN\_CRBB + i) modulo SNS, and
- 1 Positive acknowledgement of the RLC data block with BSN = (ESN\_CRBB + i) modulo SNS, where ESN\_CRBB is the ending block sequence number of CRBB and, if no CRBB is included, ESN\_CRBB = (SSN - 1) modulo SNS.

## 12.3.2 FLO Ack/Nack Description

The FLO Ack/Nack Description information element contains the RLC parameters used to acknowledge or negatively acknowledge a group of RLC data blocks.

**Table 12.3.2.1: FLO Ack/Nack Description information elements**

```

< FLO Ack/Nack Description IE > ::=
  < FLO Ack/Nack Description struct > ;

< FLO Ack/Nack Description struct > ::=
  < BEGINNING_OF_WINDOW : bit (1) >
  < END_OF_WINDOW : bit (1) >
  < STARTING_SEQUENCE_NUMBER : bit (10) >
  { 0 < COMPRESSED_BITMAP_LENGTH: bit (7) >
    < COMPRESSED_BITMAP_STARTING_COLOR_CODE: bit (1) >
    < COMPRESSED_RECEIVED_BLOCK_BITMAP: bit (val(COMPRESSED_BITMAP_LENGTH)) >
  | 1 < UNCOMPRESSED_RECEIVED_BLOCK_BITMAP: bit** > } ;

```

**Table 12.3.2.2: Ack/Nack Description information element details**

<p><b>BEGINNING_OF_WINDOW</b> (BOW, 1 bit field)</p> <p>This bit indicates whether the status of the RLC data block corresponding to <math>V(Q)</math> i.e. "0" is included in the reported bitmap or not.</p> <p>0 the reported bitmap does not cover <math>V(Q)</math>  1 the reported bitmap covers <math>V(Q)</math></p>
<p><b>END_OF_WINDOW</b> (EOW, 1 bit field)</p> <p>This bit indicates whether the end of the receiver window is included in the reported bitmap or not.</p> <p>0 <math>[V(R) - 1]</math> modulo SNS is not included in the reported bitmap.  1 <math>[V(R) - 1]</math> modulo SNS is included in the reported bitmap.</p>
<p><b>STARTING_SEQUENCE_NUMBER</b> (SSN) (10 bit field)</p> <p>Range 0 to 1023</p> <p>The SSN indicates the Block Sequence Number of the last RLC block for which the Ack/Nack receipt status is indicated within the reported bitmap. The SSN is determined as specified in 3GPP TS 44.160.</p>
<p><b>COMPRESSED_BITMAP_LENGTH</b> (Lc) (7 bit field)</p> <p>Range 0 to 127</p> <p>This field represents the length of the compressed bitmap. Compression is carried out using T.4 run length coding.</p>
<p><b>COMPRESSED_BITMAP_STARTING_COLOR_CODE</b> (1 bit field)</p> <p>This bit indicates if the first code word in the compressed bitmap (i.e. CRBB) represents a run length of ones or a run length of zeros.</p> <p>0 First code word in CRBB represents run length of zeros.  1 First code word in CRBB represents run length of ones.</p>
<p><b>COMPRESSED_RECEIVE_BLOCK_BITMAP</b> (CRBB) (Lc bit field)</p> <p>The CRBB is a compressed bitmap. Compression is carried out starting at SSN-1 and going in decreasing order of the BSN, using modified T.4 run length coding.</p> <p>The packing order of the CRBB shall be such that the codeword (or pair of make up/terminating codewords) corresponding to the run including the SSN-1 starts at the least significant bit of the CRBB, and codewords (or pairs of make-up/terminating codewords) corresponding to runs including lower and successively decreasing sequence numbers are placed in bits of successively increasing significance.</p>
<p><b>UNCOMPRESSED_RECEIVE_BLOCK_BITMAP</b> (URBB) (Lu bit field)</p> <p>The URBB is an uncompressed bitmap of length Lu bits.</p> <p>The bits in URBB, denoted here by index <math>i</math>, are numbered from <math>i=1</math> (highest order value i.e. corresponding to SSN-1) to <math>i=Lu</math> (lowest order value). The value of each bit in the bitmap is encoded as following:</p> <p>0 Negative acknowledgement of the RLC data block with <math>BSN = (SSN - 1 - i)</math> modulo SNS, and  1 Positive acknowledgement of the RLC data block with <math>BSN = (SSN - 1 - i)</math> modulo SNS</p>

### 12.3.3 EGPRS Ack/Nack Description DLMC

The EGPRS Ack/Nack Description DLMC information element contains the RLC parameters used to acknowledge or negatively acknowledge a group of RLC data blocks for a DLMC configuration. The number of bits available for the bitmap depends on the inclusion or exclusion of other information elements in the used message.



Table 12.3.3.1: EGPRS Ack/Nack Description DLMC information elements

```

< EGPRS Ack/Nack Description DLMC IE > ::=
  0 < EGPRS Ack/Nack Description struct >  -- This IE fills rest of message
  | 1 < Length L : bit (8) >                -- Value part of this IE is of length L
    { < bit (val(Length L)) > & < EGPRS Ack/Nack Description struct > };

< EGPRS Ack/Nack Description struct > ::=
  < FINAL_ACK_INDICATION : bit (1) >
  < BEGINNING_OF_WINDOW : bit (1) >
  < END_OF_WINDOW : bit (1) >
  { 0 < STARTING_SEQUENCE_NUMBER : bit (11) >
    | 1 < STARTING_SEQUENCE_NUMBER : bit (13) > }
  { 0 | 1 < COMPRESSED_BITMAP_LENGTH : bit (8) >
    < COMPRESSED_BITMAP_STARTING_COLOR_CODE : bit (1) >
    < COMPRESSED_RECEIVED_BLOCK_BITMAP :
      bit (val(COMPRESSED_BITMAP_LENGTH)) > }
  < UNCOMPRESSED_RECEIVED_BLOCK_BITMAP : bit** > ;

```

Table 12.3.3.2: EGPRS Ack/Nack Description DLMC information element details

<b>LENGTH L</b> (8 bit field) See sub-clause 12.3.1.
<b>FINAL_ACK_INDICATION</b> (1 bit field) See sub-clause 12.3.1.
<b>BEGINNING_OF_WINDOW</b> (BOW, 1 bit field) See sub-clause 12.3.1.
<b>END_OF_WINDOW</b> (EOW, 1 bit field) See sub-clause 12.3.1.
<b>STARTING_SEQUENCE_NUMBER (SSN)</b> (11 bit field) This value is included when a DLMC configuration uses a SNS of 2048 (see sub-clause 5.13).  Range 0 to 2047 The SSN indicates the Block Sequence Number of the first RLC block for which the Ack/Nack receipt status is indicated within the bitmap. The SSN is determined using S/P, PBSN and V(Q).
<b>STARTING_SEQUENCE_NUMBER (SSN)</b> (13 bit field) This value is included when a DLMC configuration uses a SNS of 8192 (see sub-clause 5.13).  Range 0 to 8191 The SSN indicates the Block Sequence Number of the first RLC block for which the Ack/Nack receipt status is indicated within the bitmap. The SSN is determined using S/P, PBSN and V(Q).
<b>COMPRESSED_BITMAP_LENGTH (Lc)</b> (7 bit field) See sub-clause 12.3.1.
<b>COMPRESSED_BITMAP_STARTING_COLOR_CODE</b> (1 bit field) See sub-clause 12.3.1.
<b>COMPRESSED_RECEIVE_BLOCK_BITMAP (CRBB)</b> (Lc bit field) See sub-clause 12.3.1.
<b>UNCOMPRESSED_RECEIVE_BLOCK_BITMAP (URBB)</b> (Lu bit field) See sub-clause 12.3.1.

## 12.4 (void)

## 12.5 EGPRS

### 12.5.1 EGPRS Channel Quality Report

The EGPRS Channel Quality Report Information Element IE is defined in tables 12.5.1.1 and 12.5.1.2. The information to be included within this IE depends on the setting of the ES/P field or CES/P field (see sub-clause 9.1.8.2.1) and on the most recently received LINK\_QUALITY\_MEASUREMENT\_MODE field (see sub-clause 11.2.7).

**Table 12.5.1.1 : EGPRS Channel Quality Report Information elements**

<p>&lt; EGPRS Channel Quality Report IE&gt; ::=</p> <ul style="list-style-type: none"> <li>&lt; <b>EGPRS BEP Link Quality Measurements</b> : &lt; EGPRS BEP Link Quality Measurements IE&gt;&gt;</li> <li>&lt; <b>C_VALUE</b> : bit (6) &gt;</li> <li>&lt; <b>EGPRS Timeslot Link Quality Measurements</b> : &lt;EGPRS Timeslot Link Quality Measurements IE &gt;&gt; ;</li> </ul>
--

**Table 12.5.1.2 : EGPRS Channel Quality Report Information Elements details**

#### **EGPRS BEP Link Quality Measurements IE**

This information element is defined in sub-clause 12.5.3.

#### **EGPRS Timeslot Link Quality Measurements**

This information element is defined in sub-clause 12.5.4.

#### **C\_VALUE** (6 bits)

This field contains the value of the C parameter calculated by the mobile station (see 3GPP TS 45.008). This field is encoded as the binary representation of the C value parameter value defined in 3GPP TS 45.008.

Range 0 to 63

### 12.5.2 EGPRS Window Size

This information element defines the window size to be used in an EGPRS TBF. The network sets the window size according to the number of timeslots assigned in the direction of the TBF.

If RLC acknowledged mode is signalled in the assignment/reconfiguration message, or if RLC unacknowledged mode is signalled and the mobile station does not support RLC non-persistent mode, the window size is defined according to Table 12.5.2.1 below.

**Table 12.5.2.1: EGPRS Window Size Information Elements details for RLC (un)acknowledged mode**

bit 5 4 3 2 1	Value of EGPRS window size	Comment
0 0 0 0 0	64	
0 0 0 0 1	96	
0 0 0 1 0	128	
0 0 0 1 1	160	
0 0 1 0 0	192	(maximum window size for a 1 timeslot TBF)
0 0 1 0 1	224	
0 0 1 1 0	256	(maximum window size for a 2 timeslot TBF)
0 0 1 1 1	288	
0 1 0 0 0	320	
0 1 0 0 1	352	
0 1 0 1 0	384	(maximum window size for a 3 timeslot TBF)
0 1 0 1 1	416	
0 1 1 0 0	448	
0 1 1 0 1	480	
0 1 1 1 0	512	(maximum window size for a 4 timeslot TBF)
0 1 1 1 1	544	
1 0 0 0 0	576	
1 0 0 0 1	608	
1 0 0 1 0	640	(maximum window size for a 5 timeslot TBF)
1 0 0 1 1	672	
1 0 1 0 0	704	
1 0 1 0 1	736	
1 0 1 1 0	768	(maximum window size for a 6 timeslot TBF)
1 0 1 1 1	800	
1 1 0 0 0	832	
1 1 0 0 1	864	
1 1 0 1 0	896	(maximum window size for a 7 timeslot TBF)
1 1 0 1 1	928	
1 1 1 0 0	960	
1 1 1 0 1	992	
1 1 1 1 0	1024	(maximum window size for an 8-16 timeslot TBF)
1 1 1 1 1	Reserved	

If RLC unacknowledged mode is signalled in the assignment/reconfiguration message, and the mobile station supports RLC non-persistent mode, RLC non-persistent mode shall be assumed by the mobile station, except when the window size is set equal to 1, and the window size is defined according to Table 12.5.2.2 below.

When a mobile station supporting RLC non-persistent mode operates in RLC unacknowledged mode (i.e. the window size is set to 1) it shall assume the maximum window size corresponding to the TBF's timeslot allocation (see Table 9.1.9.2.1) when defining the bitmap in sub-clause 9.1.8.2.

If an MBMS bearer is allocated RLC non-persistent mode shall be used. For this case the window size is defined according to Table 12.5.2.2 below.

Table 12.5.2.2: EGPRS Window Size Information Elements details for RLC non-persistent mode

bit 5 4 3 2 1	Value of EGPRS window size	Comment
0 0 0 0 0	1	This value indicates RLC unacknowledged mode is used for the EGPRS TBF
0 0 0 0 1	2	
0 0 0 1 0	4	
0 0 0 1 1	6	
0 0 1 0 0	8	
0 0 1 0 1	10	
0 0 1 1 0	12	
0 0 1 1 1	16	
0 1 0 0 0	20	
0 1 0 0 1	24	
0 1 0 1 0	32	
0 1 0 1 1	40	
0 1 1 0 0	48	
0 1 1 0 1	56	
0 1 1 1 0	64	
0 1 1 1 1	80	
1 0 0 0 0	96	
1 0 0 0 1	112	
1 0 0 1 0	128	
1 0 0 1 1	160	
1 0 1 0 0	192	(maximum window size for a 1 timeslot TBF)
1 0 1 0 1	256	(maximum window size for a 2 timeslot TBF)
1 0 1 1 0	320	
1 0 1 1 1	384	(maximum window size for a 3 timeslot TBF)
1 1 0 0 0	448	
1 1 0 0 1	512	(maximum window size for a 4 timeslot TBF)
1 1 0 1 0	576	
1 1 0 1 1	640	(maximum window size for a 5 timeslot TBF)
1 1 1 0 0	768	(maximum window size for a 6 timeslot TBF)
1 1 1 0 1	896	(maximum window size for a 7 timeslot TBF)
1 1 1 1 0	1024	(maximum window size for a 8-16 timeslot TBF)
1 1 1 1 1	Reserved	

### 12.5.3 EGPRS BEP Link Quality Measurements IE

The EGPRS BEP Link Quality measurements IE is defined in tables 12.5.3.1 and 12.5.3.2.

Table 12.5.3.1: EGPRS BEP Link Quality Information elements

```

<EGPRS BEP Link Quality Measurements IE> ::=
{ 0 | 1 < GMSK_MEAN_BEP : bit (5) >
  < GMSK_CV_BEP : bit (3) > }
{ 0 | 1 < 8PSK_MEAN_BEP : bit (5) >
  < 8PSK_CV_BEP : bit (3) > };

```

Table 12.5.3.2 : EGPRS BEP Link Quality Information Elements details

#### **GMSK\_MEAN\_BEP** (5 bit field)

This field contains the mean value of the Bit Error Probability of the channel averaged over all time slots in the TBF for GMSK, refer to 3GPP TS 45.008.

#### **8PSK\_MEAN\_BEP** (5 bit field)

This field contains the mean value of the Bit Error Probability of the channel averaged over all time slots in the TBF for 8 PSK, refer to 3GPP TS 45.008.

**GMSK\_CV\_BEP** (3 bit field)

This field contains the variation co-efficient for the Bit Error Probability averaged over all time slots of the TBF for GMSK, refer to 3GPP TS 45.008.

**8PSK\_CV\_BEP** (3 bit field)

This field contains the variation co-efficient for the Bit Error Probability averaged over all time slots of the TBF for 8 PSK, refer to 3GPP TS 45.008.

## 12.5.4 EGPRS Timeslot Link Quality Measurements IE

The EGPRS Timeslot Link Quality measurements IE is defined in tables 12.5.4.1 and 12.5.4.2.

**Table 12.5.4.1: EGPRS Timeslot Link Quality Measurements Information elements**

<EGPRS Timeslot Link Quality Measurements IE> ::=

```
{ 0 | 1 < BEP_MEASUREMENTS : BEP Measurement Report Struct >
{ 0 | 1 < INTERFERENCE_MEASUREMENTS : Interference Measurement Report Struct >};
```

---

< BEP Measurement Report Struct > ::=

```
{ 0 | 1 { 0 < GMSK_MEAN_BEP_TN0 : bit (4) >
| 1 < 8PSK_MEAN_BEP_TN0 : bit (4) >}}
{ 0 | 1 { 0 < GMSK_MEAN_BEP_TN1 : bit (4) >
| 1 < 8PSK_MEAN_BEP_TN1 : bit (4) >}}
{ 0 | 1 { 0 < GMSK_MEAN_BEP_TN2 : bit (4) >
| 1 < 8PSK_MEAN_BEP_TN2 : bit (4) >}}
{ 0 | 1 { 0 < GMSK_MEAN_BEP_TN3 : bit (4) >
| 1 < 8PSK_MEAN_BEP_TN3 : bit (4) >}}
{ 0 | 1 { 0 < GMSK_MEAN_BEP_TN4 : bit (4) >
| 1 < 8PSK_MEAN_BEP_TN4 : bit (4) >}}
{ 0 | 1 { 0 < GMSK_MEAN_BEP_TN5 : bit (4) >
| 1 < 8PSK_MEAN_BEP_TN5 : bit (4) >}}
{ 0 | 1 { 0 < GMSK_MEAN_BEP_TN6 : bit (4) >
| 1 < 8PSK_MEAN_BEP_TN6 : bit (4) >}}
{ 0 | 1 { 0 < GMSK_MEAN_BEP_TN7 : bit (4) >
| 1 < 8PSK_MEAN_BEP_TN7 : bit (4) >}};
```

---

< Interference Measurement Report Struct > ::=

```
{ 0 | 1 < I_LEVEL_TN0 : bit (4) > }
{ 0 | 1 < I_LEVEL_TN1 : bit (4) > }
{ 0 | 1 < I_LEVEL_TN2 : bit (4) > }
{ 0 | 1 < I_LEVEL_TN3 : bit (4) > }
{ 0 | 1 < I_LEVEL_TN4 : bit (4) > }
{ 0 | 1 < I_LEVEL_TN5 : bit (4) > }
{ 0 | 1 < I_LEVEL_TN6 : bit (4) > }
{ 0 | 1 < I_LEVEL_TN7 : bit (4) > };
```

Table 12.5.4.2: EGPRS Timeslot Link Quality Measurements Information Elements details

<p> <b>GMSK_MEAN_BEP_TN0</b> (4 bit field)  <b>GMSK_MEAN_BEP_TN1</b> (4 bit field)  <b>GMSK_MEAN_BEP_TN2</b> (4 bit field)  <b>GMSK_MEAN_BEP_TN3</b> (4 bit field)  <b>GMSK_MEAN_BEP_TN4</b> (4 bit field)  <b>GMSK_MEAN_BEP_TN5</b> (4 bit field)  <b>GMSK_MEAN_BEP_TN6</b> (4 bit field)  <b>GMSK_MEAN_BEP_TN7</b> (4 bit field) </p> <p> These fields contain the mean bit error probability value calculated on timeslots 0 through 7 for GMSK modulation, refer to 3GPP TS 45.008. These fields are transferred only when the mobile station is in packet transfer mode. In RTTI configuration, the mean bit error probability value calculated on per timeslot pair shall be reported on <b>GMSK_MEAN_BEP_TNx</b> where TNx is the lower numbered timeslot of each reported timeslot pair. </p>
<p> <b>8PSK_MEAN_BEP_TN0</b> (4 bit field)  <b>8PSK_MEAN_BEP_TN1</b> (4 bit field)  <b>8PSK_MEAN_BEP_TN2</b> (4 bit field)  <b>8PSK_MEAN_BEP_TN3</b> (4 bit field)  <b>8PSK_MEAN_BEP_TN4</b> (4 bit field)  <b>8PSK_MEAN_BEP_TN5</b> (4 bit field)  <b>8PSK_MEAN_BEP_TN6</b> (4 bit field)  <b>8PSK_MEAN_BEP_TN7</b> (4 bit field) </p> <p> These fields contain the mean bit error probability value calculated on timeslots 0 through 7 for 8PSK modulation, refer to 3GPP TS 45.008. These fields are transferred only when the mobile station is in packet transfer mode. In RTTI configuration, the mean bit error probability value calculated on per timeslot pair shall be reported on <b>8PSK_MEAN_BEP_TNx</b> where TNx is the lower numbered timeslot of each reported timeslot pair. </p>
<p> <b>I_LEVEL_TN0</b> (4 bit field)  <b>I_LEVEL_TN1</b> (4 bit field)  <b>I_LEVEL_TN2</b> (4 bit field)  <b>I_LEVEL_TN3</b> (4 bit field)  <b>I_LEVEL_TN4</b> (4 bit field)  <b>I_LEVEL_TN5</b> (4 bit field)  <b>I_LEVEL_TN6</b> (4 bit field)  <b>I_LEVEL_TN7</b> (4 bit field) </p> <p> These fields contain the <math>\gamma</math> value calculated on timeslots 0 through 7, respectively. The <math>\gamma</math> value is defined in 3GPP TS 45.008. These fields are encoded relative to C_VALUE as defined for the mapping defined in 3GPP TS 45.008 for interference level (I_LEVEL): </p> <pre> bit 4 3 2 1 0 0 0 0   I_LEVEL 0 0 0 0 1   I_LEVEL 1 ... 1 1 1 0   I_LEVEL 14 1 1 1 1   I_LEVEL 15 </pre>

## 12.5.5 PDCH Pairs Description

The PDCH Pairs Description information element gives the description of the uplink and downlink corresponding pairs of an RTTI configuration.

**Table 12.5.5.1: PDCH Pairs Description Information Element**

```

< PDCH Pairs Description IE > ::=
{ 0          -- Single Carrier Assignment
  { 00      -- Default PDCH pair configuration
  | 01      -- Unchanged
  | 10      -- Explicit PDCH pair configuration
    < DOWNLINK_PDCH_PAIRS_C1 : bit (8) >
    < UPLINK_PDCH_PAIRS_C1 : bit (8) >
    ! < PDCH pairs configuration error : { 1 1 } bit (*) = < no string > >    -- reserved
  }
| 1          -- Dual Carrier Assignment
  { 00      -- Default PDCH pair configuration
  | 01      -- Unchanged
  | 10      -- Explicit PDCH pair configuration
    < DOWNLINK_PDCH_PAIRS_C1 : bit (8) >
    < DOWNLINK_PDCH_PAIRS_C2 : bit (8) >
    < UPLINK_PDCH_PAIRS_C1 : bit (8) >
    < UPLINK_PDCH_PAIRS_C2 : bit (8) >
    ! < PDCH pairs configuration error : { 1 1 } bit (*) = < no string > >    -- reserved
  }
};

```

**Table 12.5.5.2: PDCH Pairs Description Information Element**

**DOWNLINK\_PDCH\_PAIRS\_C1**  
**DOWNLINK\_PDCH\_PAIRS\_C2**  
**UPLINK\_PDCH\_PAIRS\_C1**  
**UPLINK\_PDCH\_PAIRS\_C2**

These fields are defined in sub-clause 11.2.31

## 12.5a EGPRS2

### 12.5a.1 EGPRS Channel Quality Report Type 2

The EGPRS2 Channel Quality Report Type 2 Information Element is defined in tables 12.5a.1.1 and 12.5a.1.2. The information to be included within this IE depends on the setting of the ES/P field or CES/P field (see sub-clause 9.1.8.2.1) and on the most recently received LINK\_QUALITY\_MEASUREMENT\_MODE field (see sub-clause 11.2.7).

**Table 12.5a.1.1 : EGPRS Channel Quality Report Type 2 Information elements**

```

< EGPRS Channel Quality Report Type 2 IE > ::=
  < EGPRS BEP Link Quality Measurements Type 2 : < EGPRS BEP Link Quality Measurements Type 2 IE >>
  < C_VALUE : bit (6) >
  < EGPRS Timeslot Link Quality Measurements Type 2 : < EGPRS Timeslot Link Quality Measurements Type 2 IE >>
  >> ;

```

**Table 12.5a.1.2 : EGPRS Channel Quality Report Type 2 Information Elements details****EGPRS BEP Link Quality Measurements Type 2**

This information element is defined in sub-clause 12.5a.2. These fields are transferred according to the setting of the ES/P field or CES/P field, see sub-clause 9.1.8.2.1.

**EGPRS Timeslot Link Quality Measurements Type 2**

This information element is defined in sub-clause 12.5a.3.

**C\_VALUE** (6 bits)

This field contains the value of the C parameter calculated by the mobile station (see 3GPP TS 45.008). This field is encoded as the binary representation of the C value parameter value defined in 3GPP TS 45.008.

Range 0 to 63

**12.5a.2 EGPRS BEP Link Quality Measurements Type 2 IE**

The EGPRS BEP Link Quality measurements Type 2 IE is defined in tables 12.5a.2.1 and 12.5a.2.2. In the case of dual carrier configurations, "all timeslots in the TBF" shall refer only to those timeslots on the carrier to which this IE relates.

**Table 12.5a.2.1: EGPRS BEP Link Quality Measurements Type 2 Information elements**

```
<EGPRS BEP Link Quality Measurements Type 2 IE> ::=
{ 0 | 1 < GMSK_MEAN_BEP : bit (5) >
  < GMSK_CV_BEP : bit (3) > }
{ 0 | 1 < 8PSK_MEAN_BEP : bit (5) >
  < 8PSK_CV_BEP : bit (3) > }
{ 0 | 1 < QPSK_MEAN_BEP : bit (5) >
  < QPSK_CV_BEP : bit (3) > }
{ 0 | 1 < 16QAM_NSR_MEAN_BEP : bit (5) >
  < 16QAM_NSR_CV_BEP : bit (3) > }
{ 0 | 1 < 32QAM_NSR_MEAN_BEP : bit (5) >
  < 32QAM_NSR_CV_BEP : bit (3) > }
{ 0 | 1 < 16QAM_HSR_MEAN_BEP : bit (5) >
  < 16QAM_HSR_CV_BEP : bit (3) > }
{ 0 | 1 < 32QAM_HSR_MEAN_BEP : bit (5) >
  < 32QAM_HSR_CV_BEP : bit (3) > };
```

**Table 12.5a.2.2 : EGPRS BEP Link Quality Measurements Type 2 Information Elements details**

**GMSK\_MEAN\_BEP** (5 bit field)

**8PSK\_MEAN\_BEP** (5 bit field)

**QPSK\_MEAN\_BEP** (5 bit field)

**16QAM\_NSR\_MEAN\_BEP** (5 bit field)

**32QAM\_NSR\_MEAN\_BEP** (5 bit field)

**16QAM\_HSR\_MEAN\_BEP** (5 bit field)

**32QAM\_HSR\_MEAN\_BEP** (5 bit field)

These fields contain the mean value of the Bit Error Probability of the channel averaged over all timeslots in the TBF for the relevant modulation scheme, refer to 3GPP TS 45.008.

**GMSK\_CV\_BEP** (3 bit field)

**8PSK\_CV\_BEP** (3 bit field)

**QPSK\_CV\_BEP** (3 bit field)

**16QAM\_NSR\_CV\_BEP** (3 bit field)

**32QAM\_NSR\_CV\_BEP** (3 bit field)

**16QAM\_HSR\_CV\_BEP** (3 bit field)

**32QAM\_HSR\_CV\_BEP** (3 bit field)

These fields contain the variation coefficient for the Bit Error Probability averaged over all timeslots of the TBF for the relevant modulation scheme, refer to 3GPP TS 45.008.



## 12.5a.3 EGPRS Timeslot Link Quality Measurements Type 2 IE

The EGPRS Timeslot Link Quality Measurements Type 2 IE is defined in tables 12.5a.3.1 and 12.5a.3.

**Table 12.5a.3.1: EGPRS Timeslot Link Quality Measurements Type 2 Information elements**

```

<EGPRS Timeslot Link Quality Measurements Type 2 IE> ::=
{ 0 | 1 < BEP_MEASUREMENTS : BEP Measurement Report Struct >}
{ 0 | 1 < INTERFERENCE_MEASUREMENTS : Interference Measurement Report Struct >};

< BEP Measurement Report Struct > ::=
{ 0
| 1 < REPORTED_MODULATION : bit (2) >
  < MEAN_BEP_TN0 : bit (4) >
}
{ 0
| 1 < REPORTED_MODULATION : bit (2) >
  < MEAN_BEP_TN1 : bit (4) >
}
{ 0
| 1 < REPORTED_MODULATION : bit (2) >
  < MEAN_BEP_TN2 : bit (4) >
}
{ 0
| 1 < REPORTED_MODULATION : bit (2) >
  < MEAN_BEP_TN3 : bit (4) >
}
{ 0
| 1 < REPORTED_MODULATION : bit (2) >
  < MEAN_BEP_TN4 : bit (4) >
}
{ 0
| 1 < REPORTED_MODULATION : bit (2) >
  < MEAN_BEP_TN5 : bit (4) >
}
{ 0
| 1 < REPORTED_MODULATION : bit (2) >
  < MEAN_BEP_TN6 : bit (4) >
}
{ 0
| 1 < REPORTED_MODULATION : bit (2) >
  < MEAN_BEP_TN7 : bit (4) >
};

< Interference Measurement Report Struct > ::=
{ 0 | 1 < I_LEVEL_TN0 : bit (4) > }
{ 0 | 1 < I_LEVEL_TN1 : bit (4) > }
{ 0 | 1 < I_LEVEL_TN2 : bit (4) > }
{ 0 | 1 < I_LEVEL_TN3 : bit (4) > }
{ 0 | 1 < I_LEVEL_TN4 : bit (4) > }
{ 0 | 1 < I_LEVEL_TN5 : bit (4) > }
{ 0 | 1 < I_LEVEL_TN6 : bit (4) > }
{ 0 | 1 < I_LEVEL_TN7 : bit (4) > };

```

**Table 12.5a.3.2: EGPRS Timeslot Link Quality Measurements Type 2 Information Elements details**

<p> <b>MEAN_BEP_TN0</b> (4 bit field)  <b>MEAN_BEP_TN1</b> (4 bit field)  <b>MEAN_BEP_TN2</b> (4 bit field)  <b>MEAN_BEP_TN3</b> (4 bit field)  <b>MEAN_BEP_TN4</b> (4 bit field)  <b>MEAN_BEP_TN5</b> (4 bit field)  <b>MEAN_BEP_TN6</b> (4 bit field)  <b>MEAN_BEP_TN7</b> (4 bit field) </p> <p> These fields contain the mean bit error probability value calculated on timeslots 0 through 7 for the modulation scheme as indicated using the REPORTED_MODULATION field, see below. For the calculation of the mean bit error probability, refer to 3GPP TS 45.008. These fields are transferred only when the mobile station is in packet transfer mode. In RTTI configuration, the mean bit error probability value calculated on per timeslot pair shall be reported on <b>MODULATION_1_MEAN_BEP_TNx / MODULATION_2_MEAN_BEP_TNx</b> where TNx is the lower numbered timeslot of each reported timeslot pair. </p>														
<p> <b>I_LEVEL_TN0</b> (4 bit field)  <b>I_LEVEL_TN1</b> (4 bit field)  <b>I_LEVEL_TN2</b> (4 bit field)  <b>I_LEVEL_TN3</b> (4 bit field)  <b>I_LEVEL_TN4</b> (4 bit field)  <b>I_LEVEL_TN5</b> (4 bit field)  <b>I_LEVEL_TN6</b> (4 bit field)  <b>I_LEVEL_TN7</b> (4 bit field) </p> <p> These fields contain the <math>\gamma</math> value calculated on timeslots 0 through 7, respectively. The <math>\gamma</math> value is defined in 3GPP TS 45.008. These fields are encoded relative to C_VALUE as defined for the mapping defined in 3GPP TS 45.008 for interference level (I_LEVEL): </p> <table> <tr> <td>bit</td> <td></td> </tr> <tr> <td>4 3 2 1</td> <td></td> </tr> <tr> <td>0 0 0 0</td> <td>I_LEVEL 0</td> </tr> <tr> <td>0 0 0 1</td> <td>I_LEVEL 1</td> </tr> <tr> <td>...</td> <td></td> </tr> <tr> <td>1 1 1 0</td> <td>I_LEVEL 14</td> </tr> <tr> <td>1 1 1 1</td> <td>I_LEVEL 15</td> </tr> </table>	bit		4 3 2 1		0 0 0 0	I_LEVEL 0	0 0 0 1	I_LEVEL 1	...		1 1 1 0	I_LEVEL 14	1 1 1 1	I_LEVEL 15
bit														
4 3 2 1														
0 0 0 0	I_LEVEL 0													
0 0 0 1	I_LEVEL 1													
...														
1 1 1 0	I_LEVEL 14													
1 1 1 1	I_LEVEL 15													

**REPORTED\_MODULATION** (2 bit field)

The mobile station shall, for each of its currently assigned timeslots, report the modulation scheme (indicated using the REPORTED\_MODULATION field) with which it has received the largest number of blocks since the last report and shall report the MEAN\_BEP\_TNx of that modulation scheme (see the section 10.2.3.2.3 in 3GPP TS 45.008). The mapping of the modulation scheme is as follows.

For EGPRS2-A:

```
bit
2 1
0 0   GMSK
0 1   8PSK
1 0   16QAM
1 1   32QAM
```

For EGPRS2-B:

```
bit
2 1
0 0   GMSK
0 1   QPSK
1 0   16QAM with higher symbol rate
1 1   32QAM with higher symbol rate
```

In case of EGPRS2-B, if there are any received radio blocks with 8PSK, 16QAM with normal symbol rate or 32QAM with normal symbol rate, those radio blocks shall be ignored for channel quality reporting on that timeslot.

## 12.6 (void)

## 12.7 Channel Request Description

The Channel Request Description information element is sent by the mobile station to the network to request uplink resources.

**Table 12.7.1: Channel Request Description information elements**

```
< Channel Request Description IE > ::=
  < PEAK_THROUGHPUT_CLASS : bit (4) >
  < RADIO_PRIORITY : bit (2) >
  < RLC_MODE : bit (1) >
  < LLC_PDU_TYPE : bit (1) >
  < RLC_OCTET_COUNT : bit (16) >;
```

**Table 12.7.2: Channel Request Description information element details**

### **PEAK\_THROUGHPUT\_CLASS** (4 bit field)

This field indicates the peak throughput class for the PDP context of the LLC PDU that caused the Channel Request Description IE to be transmitted. The field is coded as the binary representation of the Peak Throughput Class specified in 3GPP TS 24.008.

Range: 1 to 9

### **RADIO\_PRIORITY** (2 bit field)

This field indicates the Radio Priority of the requested TBF. The field is encoded as the Radio Priority field of the Packet Channel Request (see sub-clause 11.2.5).

<p><b>RLC_MODE</b> (1 bit field) This field indicates the RLC mode of the requested TBF.</p> <p>0 RLC acknowledged mode 1 RLC unacknowledged mode</p>
<p><b>LLC_PDU_TYPE</b> (1 bit field) This field indicates the type of the first LLC PDU to be transmitted over the requested uplink TBF.</p> <p>0 LLC PDU is SACK or ACK 1 LLC PDU is not SACK or ACK</p>
<p><b>RLC_OCTET_COUNT</b> (16 bit field) The RLC_OCTET_COUNT field indicates the number of RLC data octets, plus the number of RLC data block length octets, that the mobile station wishes to transfer. The value '0' indicates that the mobile station does not provide any information on the TBF size. Range 0 to 65535</p>

## 12.7a Iu mode Channel Request Description

The *Iu mode Channel Request Description* information element is sent by the mobile station to the network to request uplink resources.

**Table 12.7a.1: Iu mode Channel Request Description information elements**

<pre>&lt; Iu mode Channel Request Description IE &gt; ::=   &lt; RB Id : bit (5) &gt;   &lt; RADIO_PRIORITY : bit (2) &gt;   { 0   1 &lt; RLC_BLOCK_COUNT : bit (8) &gt; }   { 0   1 &lt; Iu mode Channel Request Description IE &gt; } ; -- IE to be repeated only when  -- in a Multiple TBF request message</pre>
--

**Table 12.7a.2: Iu mode Channel Request Description information element details**

<p><b>RB Id</b> (5 bit field) This field indicates the radio bearer identity of the upper layer PDU that caused the Iu mode Channel Request Description IE to be transmitted. Range: 0 to 31</p>												
<p><b>RADIO_PRIORITY</b> (2 bit field) This field indicates the Radio Priority of the requested TBF. The field is encoded as the Radio Priority field of the Packet Channel Request (see sub-clause 11.2.5).</p>												
<p><b>RLC_BLOCK_COUNT</b> (8 bit field) If present, the RLC_BLOCK_COUNT field indicates the number of RLC data blocks that the mobile station wishes to transfer (assuming a CS-1 coding). This field is encoded as a binary number as shown:</p> <table> <tr> <td>bit</td> <td></td> </tr> <tr> <td>8 7 6 5 4 3 2 1</td> <td></td> </tr> <tr> <td>0 0 0 0 0 0 0 0</td> <td>9 RLC data blocks</td> </tr> <tr> <td>0 0 0 0 0 0 0 1</td> <td>10 RLC data blocks</td> </tr> <tr> <td>...</td> <td></td> </tr> <tr> <td>1 1 1 1 1 1 1 1</td> <td>264 RLC data blocks</td> </tr> </table>	bit		8 7 6 5 4 3 2 1		0 0 0 0 0 0 0 0	9 RLC data blocks	0 0 0 0 0 0 0 1	10 RLC data blocks	...		1 1 1 1 1 1 1 1	264 RLC data blocks
bit												
8 7 6 5 4 3 2 1												
0 0 0 0 0 0 0 0	9 RLC data blocks											
0 0 0 0 0 0 0 1	10 RLC data blocks											
...												
1 1 1 1 1 1 1 1	264 RLC data blocks											

## 12.7b Extended Channel Request Description

The *Extended Channel Request Description* information element is sent by the mobile station to the network to request multiple uplink resources.

**Table 12.7b.1: *Extended Channel Request Description* information elements**

<pre> &lt; Extended Channel Request Description IE &gt; ::=   &lt; PFI : bit (7) &gt;   &lt; RADIO_PRIORITY : bit (2) &gt;   &lt; RLC_MODE : bit (1) &gt;   { 0   1 &lt; LLC_PDU_TYPE : bit (1) &gt; }   { 0   1 &lt; Extended Channel Request Description IE &gt; }; -- IE to be repeated only when needed and   -- when included in a Multiple TBF request message </pre>
---

**Table 12.7b.2: *Extended Channel Request Description* information element details**

<p><b>PFI</b> (7 bit field) This field contains the PFI parameter identifying a Packet Flow Context. The PFI parameter is encoded as the contents of the PFI information element as defined in 3GPP TS 44.018.</p>
<p><b>RADIO_PRIORITY</b> (2 bit field) This field indicates the Radio Priority of the requested TBF. The field is encoded as the Radio Priority field of the Packet Channel Request (see sub-clause 11.2.5).</p>
<p><b>RLC_MODE</b> (1 bit field) This field indicates the RLC mode of the requested TBF.</p> <p>0 RLC acknowledged mode 1 RLC unacknowledged mode</p>
<p><b>LLC_PDU_TYPE</b> (1 bit field) This field indicates the type of the first LLC PDU to be transmitted over the requested uplink TBF. If the TBF request is not for an LLC PDU then this field shall be omitted.</p> <p>0 LLC PDU is SACK or ACK 1 LLC PDU is not SACK or ACK</p>

## 12.8 Frequency Parameters

The Frequency Parameters information element defines frequency parameters and a training sequence code (TSC), which may be allocated to a mobile station to define its channel configuration. All timeslots in the channel configuration of the mobile station shall use the same frequency parameters and training sequence code.

**NOTE:** For COMPACT, for PDTCH/PACCH on primary and secondary carriers that are indicated in EXT\_FREQUENCY\_LIST by parameter INT\_FREQUENCY (see 3GPP TS 45.008), the TSCs should be equal to the BCC, as defined in 3GPP TS 23.003, otherwise the accuracy of interference measurement reporting may be compromised.

The frequency parameters may consist of an ARFCN, defining a non-hopping radio frequency channel. The indirect encoding, the direct encoding 1 and the direct encoding 2 defines a hopping radio frequency channel.

**Table 12.8.1: Frequency Parameters information elements**

<pre> &lt; Frequency Parameters IE &gt; ::=   &lt; TSC : bit (3) &gt;   { 00 &lt; ARFCN : bit (10) &gt;     01 &lt; Indirect encoding : &lt; Indirect encoding struct &gt; &gt;     10 &lt; Direct encoding 1 : &lt; Direct encoding 1 struct &gt; &gt;     11 &lt; Direct encoding 2 : &lt; Direct encoding 2 struct &gt; &gt; };  &lt; Indirect encoding struct &gt; ::=   &lt; MAIO : bit (6) &gt;   &lt; MA_NUMBER : bit (4) &gt;   { 0   1 &lt; CHANGE_MARK_1 : bit (2) &gt;     { 0   1 &lt; CHANGE_MARK_2 : bit (2) &gt; } };  &lt; Direct encoding 1 struct &gt; ::=   &lt; MAIO : bit (6) &gt;   &lt; GPRS Mobile Allocation : &lt; GPRS Mobile Allocation IE &gt; &gt; ;  &lt; Direct encoding 2 struct &gt; ::=   &lt; MAIO : bit (6) &gt;   &lt; HSN : bit (6) &gt;   &lt; Length of MA Frequency List contents : bit (4) &gt;   &lt; MA Frequency List contents : octet (val(Length of MA Frequency List contents) + 3) &gt; ; </pre>
--

**Table 12.8.2: Frequency Parameters information element details**

<p><b>TSC</b> (3 bit field) This field is the binary representation of the training sequence code, see 3GPP TS 45.002. Range: 0 to 7. A mobile station that supports the extended TSC sets (see 3GPP TS 45.002 [32]) shall associate this TSC with TSC set 1 unless otherwise indicated by the Primary TSC Set field within an assignment message or a handover command.</p>
<p><b>ARFCN</b> (10 bit field) This field is the binary representation of the absolute radio frequency channel number (ARFCN) defined in 3GPP TS 45.005. Range 0 to 1023.</p>
<p><b>MAIO</b> (6 bit field) This field is the binary representation of the mobile allocation index offset (MAIO), see 3GPP TS 45.002. Range 0 to 63.</p>
<p><b>MA_NUMBER</b> (4 bit field) This field is the binary reference to a GPRS mobile allocation received in either the PSI2 information, the SI13/PSI13 information or a previous assignment message, see sub-clause 5.5.1.6. Range: 0 to 15.</p>
<p><b>CHANGE_MARK_1</b> (2 bit field) <b>CHANGE_MARK_2</b> (2 bit field) These fields are the binary representations of the allowed values for the PSI or SI <i>change mark</i> associated with the GPRS mobile allocation that the MA_NUMBER field refers to. Range: 0 to 3.</p>
<p><b>GPRS Mobile Allocation</b> (information element) The <i>GPRS Mobile Allocation</i> information element is defined in sub-clause 12.10a.</p>
<p><b>HSN</b> (6 bit field) This field is the binary representation of the hopping sequence number, see 3GPP TS 45.002. Range: 0 to 63.</p>
<p><b>MA Frequency List contents</b> (variable length octet string) This variable length octet string is the representation of a set of radio frequency channels defining a GPRS mobile allocation. The encoding of the octet string is defined by the <i>value part</i> of the type 4 information element <i>Frequency List</i>, defined in 3GPP TS 44.018. The allowed formats of the <i>Frequency List</i> information element are the <i>bit map 0</i>, <i>1024 range</i>, <i>512 range</i>, <i>256 range</i>, <i>128 range</i> and <i>variable bit map</i> formats.</p>

## 12.8.1 Abnormal cases

If the indirect encoding is used, this information element may contain the CHANGE\_MARK\_1 and 2 fields. If one of these fields is present, the receiver shall verify the validity of the PSI or SI *change mark* associated with the GPRS mobile allocation that the MA\_NUMBER field refers to, see sub-clause 5.5.1.7. None of the CHANGE\_MARK\_1 and 2 fields shall be included if the MA\_NUMBER refers to a GPRS mobile allocation received in a previous assignment message.

If the receiver detects that an inconsistency is contained in this information element, the information element shall be regarded as invalid. Such inconsistency may be that:

- an invalid PSI or SI *change mark* is associated with the referred GPRS mobile allocation;
- an CHANGE\_MARK\_1 or 2 field is included and the MA\_NUMBER refers to a GPRS mobile allocation received in a previous assignment message; or
- an undefined MA\_NUMBER or an invalid GPRS Mobile Allocation is contained in this information element.

If the inconsistency is due to an invalid PSI or SI *change mark* associated with the referred GPRS mobile allocation or an undefined MA\_NUMBER in the range 0 ñ 14, the mobile station shall initiate a *partial acquisition* of PBCCH or BCCH information (see sub-clause 5.5.1.4). It shall then obtain the PSI2 or SI13 information, which is concerned.

## 12.8.2 Dual Carrier Frequency Parameters

The Dual Carrier Frequency Parameters information element is used to define the frequency parameters for both carriers in a dual carrier configuration. It defines frequency parameters and a training sequence code (TSC), which may be allocated to a mobile station to define its channel configuration. All timeslots on each radio frequency channel in the channel configuration of the mobile station shall use the same frequency parameters and training sequence code.

The dual carrier frequency parameters may consist of two ARFCNs, defining non-hopping radio frequency channels. The dual carrier indirect encoding, the dual carrier direct encoding 1 and the dual carrier direct encoding 2 define two hopping radio frequency channels.

**Table 12.8.2.1: Dual Carrier Frequency Parameters information elements**

```

< Dual Carrier Frequency Parameters IE > ::=
  < TSC : bit (3) >
  { 00
    { 0 | 1 < ARFCN1 : bit (10) >
      < ARFCN2 : bit (10) > }
    | 01 < Indirect encoding : < Dual Carrier Indirect encoding struct > >
    | 10 < Direct encoding 1 : < Dual Carrier Direct encoding 1 struct > >
    | 11 < Direct encoding 2 : < Dual Carrier Direct encoding 2 struct > > } ;

< Dual Carrier Direct encoding 1 struct > ::=
  { 0 | 1 < MAIO1 : bit (6) > }
  { 0 | 1 < MAIO2 : bit (6) > }
  < GPRS Mobile Allocation : < GPRS Mobile Allocation IE > > ;

< Dual Carrier Indirect encoding struct > ::=
  { 0 | 1 < MAIO1 : bit (6) > }
  { 0 | 1 < MAIO2 : bit (6) > }
  < MA_NUMBER : bit (4) >
  { 0 | 1 < CHANGE_MARK_1 : bit (2) >
    { 0 | 1 < CHANGE_MARK_2 : bit (2) > } } ;

< Dual Carrier Direct encoding 2 struct > ::=
  { 0 | 1 < MAIO1 : bit (6) > }
  { 0 | 1 < MAIO2 : bit (6) > }
  < HSN : bit (6) >
  < Length of MA Frequency List contents : bit (4) >
  < MA Frequency List contents : octet (val(Length of MA Frequency List contents) + 3) > ;

```

**Table 12.8.2.2: Dual Carrier Frequency Parameters information element details**

<b>TSC</b> (3 bit field) This field is the binary representation of the training sequence code, see 3GPP TS 45.002. Range: 0 to 7. A mobile station that supports the extended TSC sets (see 3GPP TS 45.002 [32]) shall associate this TSC with TSC set 1 unless otherwise indicated by the Primary TSC Set field within an assignment message or a handover command.
<b>ARFCN1</b> (10 bit field) This field is the binary representation of the absolute radio frequency channel number (ARFCN) to be applied to carrier 1, as defined in 3GPP TS 45.005. Range 0 to 1023.
<b>ARFCN2</b> (10 bit field) This field is the binary representation of the absolute radio frequency channel number (ARFCN) to be applied to carrier 2, as defined in 3GPP TS 45.005. Range 0 to 1023.
<b>MAIO1</b> (6 bit field) This field is the binary representation of the mobile allocation index offset (MAIO) to be applied to carrier 1, see 3GPP TS 45.002. Range 0 to 63.
<b>MAIO2</b> (6 bit field) This field is the binary representation of the mobile allocation index offset (MAIO) to be applied to carrier 2, see 3GPP TS 45.002. Range 0 to 63.
<b>MA_NUMBER</b> (4 bit field) This field is the binary reference to a GPRS mobile allocation received in either the PSI2 information, the SI13/PSI13 information or a previous assignment message, see sub-clause 5.5.1.6. Range: 0 to 15.
<b>CHANGE_MARK_1</b> (2 bit field) <b>CHANGE_MARK_2</b> (2 bit field) These fields are the binary representations of the allowed values for the PSI or SI <i>change mark</i> associated with the GPRS mobile allocation that the MA_NUMBER field refers to. Range: 0 to 3.
<b>GPRS Mobile Allocation</b> (information element) The <i>GPRS Mobile Allocation</i> information element is defined in sub-clause 12.10a.
<b>HSN</b> (6 bit field) This field is the binary representation of the hopping sequence number, see 3GPP TS 45.002. Range: 0 to 63.
<b>MA Frequency List contents</b> (variable length octet string) This variable length octet string is the representation of a set of radio frequency channels defining a GPRS mobile allocation. The encoding of the octet string is defined by the <i>value part</i> of the type 4 information element <i>Frequency List</i> , defined in 3GPP TS 44.018. The allowed formats of the <i>Frequency List</i> information element are the <i>bit map 0</i> , <i>1024 range</i> , <i>512 range</i> , <i>256 range</i> , <i>128 range</i> and <i>variable bit map</i> formats.

### 12.8.3 Pulse Format description

This information element specifies on which, if any, radio frequency channels the mobile station shall transmit using the narrow pulse shaping filter or shall otherwise transmit using the wide pulse shaping filter with a specified spectrum mask (see 3GPP TS 45.004, 3GPP TS 45.005). The content of this information element is applicable only when one of UBS-5 to UBS-12 modulation and coding schemes is used.

If this information element is not included in an assignment message and the mobile station is required to transmit using EGPRS2-B modulation and coding schemes UBS-5 to UBS-12, the mobile station shall use the wide pulse shaping filter option without tight spectrum mask on all frequencies in the mobile allocation (if hopping) or on the single frequency assigned (if non-hopping).



Table 12.8.3.1: *Pulse Format* information elements

```

< Pulse Format IE > ::=
  { 0 < Pulse Format Coding 1 : bit (3) >
    | 1 < Pulse Format Coding 2 : < Pulse Format Coding 2 struct > > };

< Pulse Format Coding 2 struct > ::=
  { 0 < Pulse Format Bitmap Length: bit (7) >
    < Pulse Format Bitmap:
      bit (val (Pulse Format Bitmap Length) + 1)
      & { { 1 | 01 | 00 } ** ! { bit** = <no string> } } >
    | 1 < Non Hopping Carrier Pulse Format : 1 | 01 | 00 >
  };

```

**Pulse Format Coding 1**

The pulse shaping filter format/spectrum mask to be used on the frequencies specified in the mobile allocation are as specified in the table below. Frequency 1 is the lowest frequency, and Frequency n is the highest frequency (when ordered according to the value of their frequency in Hz).

Where 'W' is indicated, the wideband pulse option applies.

Where 'N' is indicated, the narrowband pulse option applies.

Where 'W2' is indicated, the wideband pulse with tighter spectrum mask applies.

bit	1	2	Frequency	n-1	n
3 2 1	1	2	3..(n-2)	n-1	n
0 0 0	W	W	W	W	W
0 0 1	W	W	W	W2	N
0 1 0	N	W2	W	W	W
0 1 1	N	W2	W	W2	N
1 0 0	N	N	N	N	N
1 0 1	W	W	W	W	W2
1 1 0	W2	W	W	W	W
1 1 1	W2	W	W	W	W2

**Pulse Format Coding 2:****Pulse Format Bitmap Length** (7 bit field)

Range 0 to 127

This field represents the length minus one of the **Pulse Format Bitmap** field.

**Pulse Format Bitmap** (variable length bit field)

This field comprises a bitmap with each codeword (comprising 1 or 2 bits) corresponding to a frequency specified in the mobile allocation, in increasing order of ARFCN value (except that ARFCN = 0, if included, is put last).

- 1 Wide pulse shaping filter option without tight spectrum mask applies
- 0 1 Wide pulse shaping filter option with tight spectrum mask applies
- 0 0 Narrow pulse shaping filter option applies

If the number of codewords in the bitmap is greater than the number of frequencies specified in the mobile allocation, the extra codewords shall be ignored. If the number of codewords in the bitmap is lower than the number of frequencies specified in the mobile allocation, the wide pulse shaping filter without tight spectrum mask shall apply for any frequency with no corresponding codeword.

**Non Hopping Carrier Pulse Format**

In the case of a non-hopping carrier, this field contains a single codeword that indicates which pulse format shall be used on the carrier. The meaning of the codeword values is identical as specified for the *Pulse Format Bitmap*.

## 12.8.4 DLMC Frequency Parameters

The DLMC Frequency Parameters information element defines frequency parameters allocated for a unique frequency parameter set associated with a DLMC configuration.

**Table 12.8.4.1: DLMC Frequency Parameters information elements**

<pre> &lt; DLMC Frequency Parameters IE &gt; ::=   &lt; TSC : bit (3) &gt;   { 00 &lt; ARFCN : bit (10) &gt;     01 &lt; DLMC Indirect encoding : &lt; DLMC Indirect encoding struct &gt; &gt;     10 &lt; DLMC Direct encoding 1 : &lt; DLMC Direct encoding 1 struct &gt; &gt;     11 &lt; DLMC Direct encoding 2 : &lt; DLMC Direct encoding 2 struct &gt; &gt; } ;  &lt; DLMC Indirect encoding struct &gt; ::=   &lt; MA_NUMBER : bit (4) &gt;   { 0   1 &lt; CHANGE_MARK_1 : bit (2) &gt;     { 0   1 &lt; CHANGE_MARK_2 : bit (2) &gt; } } ;  &lt; DLMC Direct encoding 1 struct &gt; ::=   &lt; GPRS Mobile Allocation : &lt; GPRS Mobile Allocation IE &gt; &gt; ;  &lt; DLMC Direct encoding 2 struct &gt; ::=   &lt; HSN : bit (6) &gt;   &lt; Length of MA Frequency List contents : bit (4) &gt;   &lt; MA Frequency List contents : octet (val(Length of MA Frequency List contents) + 3) &gt; ; </pre>
---

**Table 12.8.4.2: DLMC Frequency Parameters information element details**

<p><b>TSC</b> (3 bit field) This field is the binary representation of the training sequence code, see 3GPP TS 45.002. Range: 0 to 7.</p>
<p><b>ARFCN</b> (10 bit field) This field is the binary representation of the absolute radio frequency channel number (ARFCN) defined in 3GPP TS 45.005. Range 0 to 1023.</p>
<p><b>MA_NUMBER</b> (4 bit field) This field is the binary reference to a GPRS mobile allocation received in either the PSI2 information, the SI13/PSI13 information or a previous assignment message, see sub-clause 5.5.1.6. Range: 0 to 15.</p>
<p><b>CHANGE_MARK_1</b> (2 bit field) <b>CHANGE_MARK_2</b> (2 bit field) These fields are the binary representations of the allowed values for the PSI or SI <i>change mark</i> associated with the GPRS mobile allocation that the MA_NUMBER field refers to. Range: 0 to 3.</p>
<p><b>GPRS Mobile Allocation</b> (information element) The <i>GPRS Mobile Allocation</i> information element is defined in sub-clause 12.10a.</p>
<p><b>HSN</b> (6 bit field) This field is the binary representation of the hopping sequence number, see 3GPP TS 45.002. Range: 0 to 63.</p>
<p><b>MA Frequency List contents</b> (variable length octet string) This variable length octet string is the representation of a set of radio frequency channels defining a GPRS mobile allocation. The encoding of the octet string is defined by the <i>value part</i> of the type 4 information element <i>Frequency List</i>, defined in 3GPP TS 44.018. The allowed formats of the <i>Frequency List</i> information element are the <i>bit map 0</i>, <i>1024 range</i>, <i>512 range</i>, <i>256 range</i>, <i>128 range</i> and <i>variable bit map</i> formats.</p>

## 12.9 Global Power Control Parameters

The Global Power Control Parameters information element contains parameters the mobile station shall use to determine its TX power level. When provided, the MS shall use this information from the most recently received message.

**Table 12.9.1: Global Power Control Parameters information elements**

<p>&lt; Global Power Control Parameters IE &gt; ::=</p> <ul style="list-style-type: none"> <li>&lt; ALPHA : bit (4) &gt;</li> <li>&lt; T_AVG_W : bit (5) &gt;</li> <li>&lt; T_AVG_T : bit (5) &gt;</li> <li>&lt; Pb : bit (4) &gt;</li> <li>&lt; PC_MEAS_CHAN : bit (1) &gt;</li> <li>0                   -- The value '1' was allocated in an earlier version of the protocol and shall not be used.</li> <li>&lt; N_AVG_I : bit (4) &gt; ;</li> </ul>
---

**Table 12.9.2: Global Power Control Parameters information element details**

<p><b>ALPHA</b> (4 bit field)</p> <p>This field is the binary representation of the parameter <math>\alpha</math> for MS output power control in units of 0.1, see 3GPP TS 45.008.</p> <p>Range: 0 to 10. The ALPHA power control parameter field is coded according to the following table:</p> <table style="border: none;"> <tr><td colspan="2">bit</td></tr> <tr><td>4 3 2 1</td><td></td></tr> <tr><td>0 0 0 0</td><td><math>\alpha = 0.0</math></td></tr> <tr><td>0 0 0 1</td><td><math>\alpha = 0.1</math></td></tr> <tr><td>0 0 1 0</td><td><math>\alpha = 0.2</math></td></tr> <tr><td>:</td><td>:</td></tr> <tr><td>1 0 0 1</td><td><math>\alpha = 0.9</math></td></tr> <tr><td>1 0 1 0</td><td><math>\alpha = 1.0</math></td></tr> </table> <p>All other values are reserved in this version of the protocol and shall be interpreted by the mobile station as <math>\alpha = 1.0</math>.</p>	bit		4 3 2 1		0 0 0 0	$\alpha = 0.0$	0 0 0 1	$\alpha = 0.1$	0 0 1 0	$\alpha = 0.2$	:	:	1 0 0 1	$\alpha = 0.9$	1 0 1 0	$\alpha = 1.0$
bit																
4 3 2 1																
0 0 0 0	$\alpha = 0.0$															
0 0 0 1	$\alpha = 0.1$															
0 0 1 0	$\alpha = 0.2$															
:	:															
1 0 0 1	$\alpha = 0.9$															
1 0 1 0	$\alpha = 1.0$															
<p><b>T_AVG_W</b> (5 bit field)</p> <p>The T_AVG_W parameter is a signal strength filter period for power control in packet idle mode. <math>2^{(k/2)} / 6</math> multiframes, <math>k = 0, 1, 2, \dots, 25</math> (see 3GPP TS 45.008). Values greater than 25 shall be interpreted as 25 by the mobile station.</p>																
<p><b>T_AVG_T</b> (5 bit field)</p> <p>The T_AVG_T parameter is a signal strength filter period for power control in packet transfer mode. <math>2^{(k/2)} / 6</math> multiframes, <math>k = 0, 1, 2, \dots, 25</math> (see 3GPP TS 45.008). Values greater than 25 shall be interpreted as 25 by the mobile station.</p>																
<p><b>Pb</b> (4 bit field)</p> <p>The Pb parameter is a power reduction value used by the BTS on PBCCH blocks and PCCCH blocks, relative to the output power used on BCCH. The field is coded according to the following table:</p> <table style="border: none;"> <tr><td colspan="2">bit</td></tr> <tr><td>4 3 2 1</td><td></td></tr> <tr><td>0 0 0 0</td><td>Pb = 0 dB</td></tr> <tr><td>0 0 0 1</td><td>Pb = -2 dB</td></tr> <tr><td>0 0 1 0</td><td>Pb = -4 dB</td></tr> <tr><td>:</td><td>:</td></tr> <tr><td>1 1 1 1</td><td>Pb = -30 dB</td></tr> </table>	bit		4 3 2 1		0 0 0 0	Pb = 0 dB	0 0 0 1	Pb = -2 dB	0 0 1 0	Pb = -4 dB	:	:	1 1 1 1	Pb = -30 dB		
bit																
4 3 2 1																
0 0 0 0	Pb = 0 dB															
0 0 0 1	Pb = -2 dB															
0 0 1 0	Pb = -4 dB															
:	:															
1 1 1 1	Pb = -30 dB															
<p><b>PC_MEAS_CHAN</b> (1 bit field)</p> <p>The PC_MEAS_CHAN parameter indicates where the mobile station shall measure the received power level on the downlink for the purpose of the uplink power control.</p> <table style="border: none;"> <tr><td>0</td><td>downlink measurements for power control shall be made on BCCH</td></tr> <tr><td>1</td><td>downlink measurements for power control shall be made on PDCH</td></tr> </table>	0	downlink measurements for power control shall be made on BCCH	1	downlink measurements for power control shall be made on PDCH												
0	downlink measurements for power control shall be made on BCCH															
1	downlink measurements for power control shall be made on PDCH															

**N\_AVG\_I** (4 bit field)

The N\_AVG\_I parameter is an interfering signal strength filter constant for power control  $2^{(k/2)}$ , k=0, 1, ..., 15 (see 3GPP TS 45.008).

Range: 0 to 15

## 12.9a GPRS Power Control Parameters

The *GPRS Power Control Parameters* information element contains parameters the mobile station shall use to determine its TX power level.

**Table 12.9a.1: GPRS Power Control Parameters information element**

```
< GPRS Power Control Parameters IE > ::=
  < ALPHA : bit (4) >
  < T_AVG_W : bit (5) >
  < T_AVG_T : bit (5) >
  < PC_MEAS_CHAN : bit >
  < N_AVG_I : bit (4) > ;
```

**Table 12.9a.2: GPRS Power Control Parameters information element details**

**ALPHA** (4 bit field),

**T\_AVG\_W** (5 bit field),

**T\_AVG\_T** (5 bit field),

**PC\_MEAS\_CHAN** (1 bit field) and

**N\_AVG\_I** (4 bit field)

These fields are defined in the *Global Power Control Parameters* information element, see sub-clause 12.9.

## 12.10 Global TFI

The Global TFI (Temporary Flow Identity) information element contains either an uplink TFI or a downlink TFI. The uplink or downlink TFI identifies a single Temporary Block Flow.

**Table 12.10.1: Global TFI information elements**

```
< Global TFI IE > ::=
  { 0 < UPLINK_TFI : bit (5) >
  | 1 < DOWNLINK_TFI : bit (5) > } ;
```

**Table 12.10.2: Global TFI information element details**

**UPLINK\_TFI** (5 bit field)

This field identifies an uplink TBF. This field is coded the same as the TFI field defined in sub-clause 12.15.

**DOWNLINK\_TFI** (5 bit field)

This field identifies a downlink TBF. This field is coded the same as the TFI field defined in sub-clause 12.15.

### 12.10a GPRS Mobile Allocation

The GPRS Mobile Allocation information element defines a set of radio frequency channels and a hopping sequence number (HSN), which may be allocated to a mobile station to define its channel configuration.

This information element may refer to a reference frequency list, or set of reference frequency lists defined in the PSI2 information. In case there is no such reference included in this information element, it refers to the cell allocation (CA) defined for the cell. The cell allocation is defined in the PSI2 information, if PBCCH is present in the cell, or in the SI1 information (see 3GPP TS 44.018), if PBCCH is not present in the cell.

There are two alternative ways to encode the GPRS mobile allocation, using the MA\_BITMAP or the ARFCN index list.

**Table 12.10a.1: GPRS Mobile Allocation information elements**

<pre> &lt; GPRS Mobile Allocation IE &gt; ::=   &lt; HSN : bit (6) &gt;   { 0   1 &lt; RFL number list : &lt; RFL number list struct &gt; &gt; }   { 0 &lt; MA_LENGTH : bit (6) &gt;     &lt; MA_BITMAP : bit (val(MA_LENGTH) + 1) &gt;       1 { 0   1 &lt; ARFCN index list : &lt; ARFCN index list struct &gt; &gt; } }; &lt; RFL number list struct &gt; ::=   &lt; RFL_NUMBER : bit (4) &gt;   { 0   1 &lt; RFL number list struct &gt; }; &lt; ARFCN index list struct &gt; ::=   &lt; ARFCN_INDEX : bit (6) &gt;   { 0   1 &lt; ARFCN index list struct &gt; }; </pre>
---

**Table 12.10a.2: GPRS Mobile Allocation information element details**

<p><b>HSN</b> (6 bit field) This field is the binary representation of the hopping sequence number, see 3GPP TS 45.002. Range: 0 to 63.</p>
<p><b>RFL number list</b> (construction) This construction is a list specifying the referenced set of reference frequency lists for this information element. If the list is not included, this information element refers to the cell allocation defined for the cell.</p> <p>The number of radio frequency channels included in the referenced set of reference frequency lists or the referenced cell allocation (excluding any duplication of radio frequency channels) is denoted NF. The radio frequency channels shall be arranged by the receiver of this information element in the order of ascending ARFCN, except for ARFCN = 0, if included, which shall be put last. Each radio frequency channel shall then be assigned an ARFCN_INDEX value, ranging from zero, for the first radio frequency channel, to NF-1, for the last radio frequency channel in the ordered set.</p>
<p><b>MA_BITMAP</b> (variable length, 1 to 64 bit, field) This field is a bitmap representing the radio frequency channels belonging to the GPRS mobile allocation. The number of bit positions in MA_BITMAP shall equal NF. The first bit position in MA_BITMAP corresponds to ARFCN_INDEX = NF-1, the last position corresponds to ARFCN_INDEX = 0. Each bit position is coded:</p> <p>0 the corresponding radio frequency channel does not belong to the GPRS mobile allocation; 1 the corresponding radio frequency channel belongs to the GPRS mobile allocation.</p>
<p><b>ARFCN index list</b> (construction) This construction is a list representing a set of radio frequency channels to be excluded from the definition of the GPRS mobile allocation. The GPRS mobile allocation is defined as consisting of the radio frequency channels included in the referenced set of reference frequency lists or the referenced cell allocation, except those represented by the ARFCN index list. If the list is not included, this information element defines a GPRS mobile allocation consisting of all radio frequency channels included in the referenced set of reference frequency lists or the referenced cell allocation, without exception.</p>
<p><b>RFL_NUMBER</b> (4 bit field) This field is the binary reference to a reference frequency list provided in PSI2. Range 0 to 15.</p>
<p><b>ARFCN_INDEX</b> (6 bit field) This field is the binary reference to a radio frequency channels in the referenced set of reference frequency lists or the referenced cell allocation. Range: 0 to NF-1.</p>

## 12.10a.1 Abnormal cases

If the receiver of this information element detects any inconsistency between the encoding of this information element and the referenced frequency information (i.e. an MA\_BITMAP length or an ARFCN\_INDEX value out of range, or an undefined RFL\_NUMBER value), the information element shall be regarded as invalid.

## 12.10b (void)

## 12.10c (void)

## 12.10d EGPRS Modulation and coding Scheme description

This information element defines the modulation and coding scheme to be used.

**Table 12.10d.1: EGPRS MCS information element details**

EGPRS modulation and coding scheme information element	
bits 4 3 2 1	value
0 0 0 0	MCS-1
0 0 0 1	MCS-2
0 0 1 0	MCS-3
0 0 1 1	MCS-4
0 1 0 0	MCS-5
0 1 0 1	MCS-6
0 1 1 0	MCS-7
0 1 1 1	MCS-8
1 0 0 0	MCS-9
1 0 0 1	MCS-5-7
1 0 1 0	MCS-6-9
1 0 1 1 to 1 1 1 1	reserved

In EGPRS2, this information element defines the modulation and coding scheme to be used. The value depends on the assigned EGPRS level, see sub-clause 12.10f.

**Table 12.10d.2: EGPRS MCS information element details (EGPRS2-A)**

EGPRS modulation and coding scheme information element	
bits 4 3 2 1	value
0 0 0 0	MCS-1
0 0 0 1	MCS-2
0 0 1 0	MCS-3
0 0 1 1	MCS-4
0 1 0 0	MCS-5
0 1 0 1	MCS-6
0 1 1 0	UAS-7
0 1 1 1	UAS-8
1 0 0 0	UAS-9
1 0 0 1	UAS-10
1 0 1 0	UAS-11
1 0 1 1 to 1 1 1 1	reserved

Table 12.10d.3: *EGPRS MCS* information element details (EGPRS2-B)

EGPRS modulation and coding scheme information element	
bits 4 3 2 1	value
0 0 0 0	MCS-1
0 0 0 1	MCS-2
0 0 1 0	MCS-3
0 0 1 1	MCS-4
0 1 0 0	UBS-5
0 1 0 1	UBS-6
0 1 1 0	UBS-7
0 1 1 1	UBS-8
1 0 0 0	UBS-9
1 0 0 1	UBS-10
1 0 1 0	UBS-11
1 0 1 1	UBS-12
1 1 0 0 to 1 1 1 1	reserved

## 12.10e RESEGMENT description

The RESEGMENT field defines whether retransmitted uplink RLC data blocks shall be re-segmented or not.

Table 12.10e.1: *RESEGMENT* information element details

<b>RESEGMENT</b> (1 bit field)	
0	Retransmitted RLC data blocks shall not be re-segmented
1	Retransmitted RLC data blocks shall be re-segmented according to commanded MCS

## 12.10f EGPRS Level description

This information element defines the EGPRS level for this TBF and consequently the the set of modulation and coding schemes which shall be used.

Table 12.10f.1: *EGPRS Level* information element details

EGPRS Level information element	
bits 2 1	value
0 0	EGPRS
0 1	EGPRS2-A
1 0	EGPRS2-B
1 1	reserved

## 12.11 Packet Request Reference

The purpose of the Packet Request Reference information element is to provide the information field sent in the Packet Channel Request (i.e. the PACKET CHANNEL REQUEST or EGPRS PACKET CHANNEL REQUEST message) and the frame number, FN modulo 42432, in which the Packet Channel Request was received.

**Table 12.11.1: Packet Request Reference information elements**

< Packet Request Reference IE > ::= < <b>RANDOM_ACCESS_INFORMATION</b> value : bit (11) > < <b>FRAME_NUMBER</b> : bit (16) > ;
--

**Table 12.11.2: Packet Request Reference information element details**

<b>RANDOM_ACCESS_INFORMATION</b> value (11 bit field)											
This is an unformatted 11 bit field. If the mobile station used the 11-bit message format in the Packet Channel Request, all 11 bits of this field are valid. Otherwise, only bits 8 through 1 are valid and bits 11 through 9 shall be set to '0'											
	Bit										
	11	10	9	8	7	6	5	4	3	2	1
11-bit message format used	X	X	X	X	X	X	X	X	X	X	X
8-bit message format used	0	0	0	X	X	X	X	X	X	X	X
<b>FRAME_NUMBER</b> (16 bit field)											
This field is encoded the same as the Starting Time information element defined in 3GPP TS 44.018.											

## 12.12 Packet Timing Advance

The Packet Timing Advance field describes the timing advance mode and timing advance value assigned to the mobile station.

**Table 12.12.1: Packet Timing Advance information elements**

< Packet Timing Advance IE > ::= { 0   1 < <b>TIMING_ADVANCE_VALUE</b> : bit (6) > } { 0   1 < <b>TIMING_ADVANCE_INDEX</b> : bit (4) > < <b>TIMING_ADVANCE_TIMESLOT_NUMBER</b> : bit (3) > } ;
---

**Table 12.12.2: Packet Timing Advance information element details**

<b>TIMING_ADVANCE_VALUE</b> (6 bit field)
If the TIMING_ADVANCE_VALUE field is present, the mobile station shall use the value contained therein after time defined in 3GPP TS 45.010. If the TIMING_ADVANCE_VALUE field is not present the mobile station shall not change its timing advance value. The Timing Advance value field is encoded the same as the Timing Advance value of the Timing Advance information element defined in 3GPP TS 44.018



**TIMING\_ADVANCE\_INDEX** (4 bit field)

If the **TIMING\_ADVANCE\_INDEX** and **TIMING\_ADVANCE\_TIMESLOT\_NUMBER** fields are present the mobile station shall begin operation of the Continuous Timing Advance procedure at the point in time denoted by the TBF starting time if present, otherwise after the reaction time specified in 3GPP TS 45.010. If these two fields are not present the mobile station shall stop operation of the Continuous Timing Advance procedure. This information field is encoded as a binary representation of the Timing Advance Index defined in 3GPP TS 45.002.

Range 0 to 15.

**TIMING\_ADVANCE\_TIMESLOT\_NUMBER** (3 bit field)

This field indicates the timeslot assigned for the Continuous Timing Advance procedure on the PTCCCH. This field is coded as the binary representation of the timeslot number as defined in 3GPP TS 45.010.

Range 0 to 7

## 12.12a Global Packet Timing Advance

The Global Packet Timing Advance field describes the timing advance mode and timing advance value assigned to the mobile station for uplink and/or downlink TBF.

**Table 12.12a.1: Global Packet Timing Advance information elements**

```

< Global Packet Timing Advance IE > ::=
  { 0 | 1 < TIMING_ADVANCE_VALUE : bit (6) > }
  { 0 | 1 < UPLINK_TIMING_ADVANCE_INDEX : bit (4) >
    < UPLINK_TIMING_ADVANCE_TIMESLOT_NUMBER : bit (3) > }
  { 0 | 1 < DOWNLINK_TIMING_ADVANCE_INDEX : bit (4) >
    < DOWNLINK_TIMING_ADVANCE_TIMESLOT_NUMBER : bit (3) > }

```

**Table 12.12a.2: Global Packet Timing Advance information element details**

**TIMING\_ADVANCE\_VALUE** (6 bit field)

If the **TIMING\_ADVANCE\_VALUE** field is present, the mobile station shall use the value contained therein after time defined in 3GPP TS 45.010. If the **TIMING\_ADVANCE\_VALUE** field is not present the mobile station shall not change its timing advance value. The Timing Advance value field is encoded the same as the Timing Advance value of the Timing Advance information element defined in 3GPP TS 44.018

**UPLINK\_TIMING\_ADVANCE\_INDEX** (4 bit field)

This field indicates the Timing Advance Index related to Uplink TBF. This information field is encoded as a binary representation of the Timing Advance Index defined in 3GPP TS 45.002.

Range 0 to 15.

**UPLINK\_TIMING\_ADVANCE\_TIMESLOT\_NUMBER** (3 bit field)

This field indicates the timeslot assigned for the Continuous Timing Advance procedure on the PTCCCH related to Uplink TBF. This field is coded as the binary representation of the timeslot number as defined in 3GPP TS 45.010.

Range 0 to 7

**DOWNLINK\_TIMING\_ADVANCE\_INDEX** (4 bit field)

This field indicates the Timing Advance Index related to Downlink TBF. This information field is encoded as a binary representation of the Timing Advance Index defined in 3GPP TS 45.002.

Range 0 to 15.

**DOWNLINK\_TIMING\_ADVANCE\_TIMESLOT\_NUMBER** (3 bit field)

This field indicates the timeslot assigned for the Continuous Timing Advance procedure on the PTCCCH related to Downlink TBF. This field is coded as the binary representation of the timeslot number as defined in 3GPP TS 45.010. Range 0 to 7

If Timing Advance Index and Timing Advance Timeslot Number are present for any of the TBFs already existing or to be established with this message, the mobile station shall begin operation of the Continuous Timing Advance procedure at the point in time denoted by the TBF starting time if present, otherwise within the reaction time specified in 3GPP TS 45.010.

If Timing Advance Index and Timing Advance Timeslot Number are not present for any of the TBFs already existing or to be established with this message, the mobile station shall stop operation of the Continuous Timing Advance procedure.

## 12.12b Packet Extended Timing Advance

The Packet Extended Timing Advance field is a 2 bit field used to support Extended Timing Advance. These two bits represent the two most significant bits of the timing advance value to be applied by the mobile station. The coding of the timing advance value is defined in the Timing Advance IE defined in 3GPP TS 44.018. The mapping of the two bits of the Packet Extended Timing Advance field is defined as follows:

Bit

- 1 bit 7 of the Timing Advance IE defined in 3GPP TS 44.018
- 2 bit 8 of the Timing Advance IE defined in 3GPP TS 44.018

The least significant bits of a timing advance value is provided the **TIMING\_ADVANCE\_VALUE** field in either a Packet Timing Advance IE (sub-clause 12.12) or a Global Packet Timing Advance IE (sub-clause 12.12a). If the least significant bits of the timing advance value is not provided in the message, then the Packet Extended Timing Advance field shall be ignored.

## 12.13 Power Control Parameters

The Power Control Parameters information element contains parameters the mobile station shall use to determine its TX power level.

**Table 12.13.1: Power Control Parameters information elements**

```

< Power Control Parameters IE > ::=
  < ALPHA : bit (4) >
  { 0 | 1 < GAMMA_TN0 : bit (5) > }
  { 0 | 1 < GAMMA_TN1 : bit (5) > }
  { 0 | 1 < GAMMA_TN2 : bit (5) > }
  { 0 | 1 < GAMMA_TN3 : bit (5) > }
  { 0 | 1 < GAMMA_TN4 : bit (5) > }
  { 0 | 1 < GAMMA_TN5 : bit (5) > }
  { 0 | 1 < GAMMA_TN6 : bit (5) > }
  { 0 | 1 < GAMMA_TN7 : bit (5) > };

```

**Table 12.13.2: Power Control Parameters information element details**

<p><b>ALPHA</b> (4 bit field) For encoding and description see the Global Power Control Parameters IE.</p> <p><b>GAMMA_TN0</b> (5 bit field)  <b>GAMMA_TN1</b> (5 bit field)  <b>GAMMA_TN2</b> (5 bit field)  <b>GAMMA_TN3</b> (5 bit field)  <b>GAMMA_TN4</b> (5 bit field)  <b>GAMMA_TN5</b> (5 bit field)  <b>GAMMA_TN6</b> (5 bit field)  <b>GAMMA_TN7</b> (5 bit field)</p> <p>The GAMMA_TN0..7 fields are the binary representation of the parameter <math>\Gamma_{CH}</math> for MS output power control in units of 2 dB, see 3GPP TS 45.008. GAMMA_TN0 contains the gamma value for timeslot number 0, GAMMA_TN1 contains the gamma value for timeslot number 1, etc. The GAMMA_TN0..7 field is coded according to the following table:</p> <table> <tr> <td>bit</td> <td></td> </tr> <tr> <td>5 4 3 2 1</td> <td></td> </tr> <tr> <td>0 0 0 0 0</td> <td><math>\Gamma_{CH} = 0</math> dB</td> </tr> <tr> <td>0 0 0 0 1</td> <td><math>\Gamma_{CH} = 2</math> dB</td> </tr> <tr> <td>...</td> <td></td> </tr> <tr> <td>1 1 1 1 0</td> <td><math>\Gamma_{CH} = 60</math> dB</td> </tr> <tr> <td>1 1 1 1 1</td> <td><math>\Gamma_{CH} = 62</math> dB</td> </tr> </table>	bit		5 4 3 2 1		0 0 0 0 0	$\Gamma_{CH} = 0$ dB	0 0 0 0 1	$\Gamma_{CH} = 2$ dB	...		1 1 1 1 0	$\Gamma_{CH} = 60$ dB	1 1 1 1 1	$\Gamma_{CH} = 62$ dB
bit														
5 4 3 2 1														
0 0 0 0 0	$\Gamma_{CH} = 0$ dB													
0 0 0 0 1	$\Gamma_{CH} = 2$ dB													
...														
1 1 1 1 0	$\Gamma_{CH} = 60$ dB													
1 1 1 1 1	$\Gamma_{CH} = 62$ dB													

## 12.14 PRACH Control Parameters

The purpose of the PRACH Control Parameters information element is to provide parameters used to control the PRACH utilization.

**Table 12.14.1: PRACH Control Parameters information elements**

<pre> &lt; PRACH Control Parameters IE &gt; ::=   &lt; ACC_CONTR_CLASS : bit (16) &gt;   &lt; MAX_RETRANS : bit (2) &gt; * 4   &lt; S : bit (4) &gt;   &lt; TX_INT : bit (4) &gt;   { 0   1 &lt; PERSISTENCE_LEVEL : bit (4) &gt; * 4 }; </pre>
---

**Table 12.14.2: PRACH Control Parameters information element details**

<b>TX_INT</b> (4 bit field)	
Number of slots to spread transmission of the random access. The field is coded according to the following table:	
bit	
4 3 2 1	
0 0 0 0	2 slots used to spread transmission
0 0 0 1	3 slots used to spread transmission
0 0 1 0	4 slots used to spread transmission
0 0 1 1	5 slots used to spread transmission
0 1 0 0	6 slots used to spread transmission
0 1 0 1	7 slots used to spread transmission
0 1 1 0	8 slots used to spread transmission
0 1 1 1	9 slots used to spread transmission
1 0 0 0	10 slots used to spread transmission
1 0 0 1	12 slots used to spread transmission
1 0 1 0	14 slots used to spread transmission
1 0 1 1	16 slots used to spread transmission
1 1 0 0	20 slots used to spread transmission
1 1 0 1	25 slots used to spread transmission
1 1 1 0	32 slots used to spread transmission
1 1 1 1	50 slots used to spread transmission
<b>S</b> (4 bit field)	
S is a parameter used for calculation of the minimum number of slots between two successive Channel request messages. The field is coded according to the following table:	
bit	
4 3 2 1	
0 0 0 0	S = 12
0 0 0 1	S = 15
0 0 1 0	S = 20
0 0 1 1	S = 30
0 1 0 0	S = 41
0 1 0 1	S = 55
0 1 1 0	S = 76
0 1 1 1	S = 109
1 0 0 0	S = 163
1 0 0 1	S = 217
All other values reserved.	

**MAX\_RETRANS** (2 bit field for each Radio Priority 1..4)

Indicates for each Radio Priority level 1 to 4 the maximum number of retransmissions allowed. Radio Priority 1 represents the highest priority. The field is coded with two bits per Radio Priority level according to the following table where the first two bits refer to Radio Priority 1, the second two bits to Radio Priority 2, etc.:

bit	
2 1	
0 0	1 retransmission allowed
0 1	2 retransmissions allowed
1 0	4 retransmissions allowed
1 1	7 retransmissions allowed

**PERSISTENCE\_LEVEL** (4 bit field for each Radio Priority 1..4)

The PERSISTENCE\_LEVEL field indicates the values of the access persistence level P(i) for each Radio Priority i (i = 1..4) where Radio Priority 1 represents the highest Radio Priority of an LLC PDU to be transmitted.

bits	
4 3 2 1	
0 0 0 0	persistence level 0
0 0 0 1	persistence level 1
0 0 1 0	persistence level 2
0 0 1 1	persistence level 3
0 1 0 0	persistence level 4
:::	
1 1 1 0	persistence level 14
1 1 1 1	persistence level 16

**ACC\_CONTR\_CLASS** ( 16 bit field)

Access Control Class N (bit 1-16) (see octet 3 and 4 of the RACH Control Parameters IE in 3GPP TS 44.018) . For a mobile station with Access Control Class =N access is not barred if the Access Control Class N bit is coded with a '0'; N = 0, 1, ..., 9, 11, ..., 15. Bit 11= the EC bit is the Emergency Call Allowed coded as specified in 3GPP TS 44.018.

Bits:	16	15	14	13	12	11	10	9	8	7	6	5	4	3	2	1
Class N:	15	14	13	12	11	EC	9	8	7	6	5	4	3	2	1	0

## 12.15 Temporary Flow Identity (TFI)

The Temporary Flow Identity (TFI) uniquely identifies either a single uplink Temporary Block Flow (TBF) or a single downlink Temporary Block Flow (TBF).

**Table 12.15.1: UPLINK\_TFI information element details**

**UPLINK\_TFI** (5 bit field)

The Temporary Flow Identity field identifies an uplink Temporary Block Flow (TBF). This field is encoded as a binary number.

Range 0 to 31

**Table 12.15.2: DOWNLINK\_TFI information element details**

**DOWNLINK\_TFI** (5 bit field)

The Temporary Flow Identity field identifies a downlink Temporary Block Flow (TBF). This field is encoded as a binary number.

Range 0 to 31

## 12.16 Temporary Logical Link Identity (TLLI)/G-RNTI

The Temporary Logical Link Identity (TLLI) is associated with the GPRS subscriber. TLLI is defined in 3GPP TS 23.003.

The TLLI codespace is re-used in some messages and contains the first 28 bits of the G-RNTI as defined in 3GPP TS 23.003. The G-RNTI is defined in 3GPP TS 44.160.

**Table 12.16.1: TLLI information element details**

**TLLI/G-RNTI** (32 bit field)

The TLLI / G-RNTI field is encoded as a binary number.  
Range 0 to 4294967295

### 12.16a GERAN Radio Network Temporary Identity (G-RNTI)

The G-RNTI (GERAN Radio Network Temporary Identity) is allocated to an MS at the RRC layer having a RRC connection and identifies the MS within GERAN. It is used by the RLC/MAC layer for contention resolution and to identify an MS.

NOTE: The RRC layer uses the G-RNTI defined in 44.118

< G-RNTI IE > ::=

< **S-RNTI** : bit (20) >

< **Serving BSC Identity** : bit (12) > ;

**Serving BSC identity** (12 bit field)

This field identifies the mobile station's serving BSC in GERAN.

**S-RNTI** (20 bit field)

This field identifies the mobile station within the serving BSC.

## 12.17 Temporary Queueing Identifier (TQI)

The Temporary Queueing Identifier (TQI) field identifies a mobile station during the queueing procedure. The contents of this field are operator defined.

**Table 12.17.1: TQI information element details**

**TQI** (16 bit field)

The Temporary Queueing Identifier field is an unformatted field.

## 12.18 TIMESLOT\_ALLOCATION

The TIMESLOT\_ALLOCATION field indicates the timeslots for use during a TBF, the timeslots carrying a PCCCH or the timeslots for which feedback is provided by a time-based encoded PAN field.

**Table 12.18.1: TIMESLOT\_ALLOCATION information element details**

### TIMESLOT\_ALLOCATION (8 bit field)

This information field indicates the timeslots assigned for use during the TBF, the timeslots carrying a PCCCH or the timeslots for which feedback is provided by a time-based encoded PAN field. Bit 8 indicates the status of timeslot 0, bit 7 indicates the status of timeslot 1, etc. At least one timeslot must be assigned. When used to indicate the timeslots constituting PDCH-pairs for which feedback is provided by a time-based encoded PAN field (for TBFs in RTTI or MTTI configuration configuration) an even number of timeslots must be indicated.

- 0 Timeslot is not assigned
- 1 Timeslot is assigned

## 12.19 (void)

## 12.20 PAGE\_MODE

The PAGE\_MODE field controls the action of the mobile station belonging to the paging subgroup corresponding to the paging subchannel.

**Table 12.20.1 : PAGE\_MODE information element details**

### PAGE\_MODE (2 bit field)

bit	value
2 1	value
0 0	Normal Paging
0 1	Extended Paging
1 0	Paging Reorganization
1 1	Same as before

## 12.21 Starting Frame Number Description

There are two types of encoding for this IE : Relative Frame Number or Absolute Frame Number.

**Table 12.21.1: Starting Frame Number Description information element**

```
< Starting Frame Number Description IE > ::=
  { 0 < Absolute Frame Number Encoding >
  | 1 < Relative Frame Number Encoding > } ;
```

If the mobile station is in packet transfer mode during the block immediately before the starting time and the lowest numbered PDCH assigned to the MS is different immediately before and after the starting time then the mobile station shall be ready to receive or transmit no later than one radio block from the starting time (see 3GPP TS 45.002).

### 12.21.1 Absolute Frame Number Encoding

In this case, the field is encoded as the 16-bit Starting Time IE defined in 3GPP TS 44.018, and the value of the Starting FN is obtained directly.

If the Starting FN is not aligned to the start of a block period and the mobile station is in packet transfer mode during the TDMA immediately before the Starting FN, then the mobile station shall align the starting time to the next block boundary and continue to use the currently assigned allocation upto the next block boundary.

## 12.21.2 Relative Frame Number Encoding

In this case, the field indicates the delay, relative to the first TDMA frame (N) of the RLC/MAC block containing the Starting Time field, before the assigned or requested resource becomes valid.

The value of this field is the 13 bit binary representation of the integer k, from which the offset to be applied to N can be derived.

The value of the Starting Frame Number is calculated as follows:

For (k mod 3) equal to:	The value of the Starting Frame Number is:
0 or 1	$N + 4 + 4k + (k \text{ div} 3)$ , $N + 5 + 4k + (k \text{ div} 3)$ (NOTE 1)
2	$N + 5 + 4k + (k \text{ div} 3)$
$0 \leq k \leq 8191$	

EXAMPLE: Starting Frame Number Description (13-bit field):

k = 1	0000000000001	block with first TDMA frame number = N+8 or N+9
k = 2	0000000000010	block with first TDMA frame number = N+13
k = 3	0000000000011	block with first TDMA frame number = N+17 or N+18

NOTE 1: In these cases, only one of the frame numbers  $N+4+4k+k\text{div}3$  or  $N+5+4k+k\text{div}3$  is valid, because the other corresponds to an idle frame, depending on the position of the block in the multi-frame.

NOTE 2: The value of (k+1) gives the number of relative blocks. The maximum number of relative blocks is therefore 8 192; this value was chosen according to the interval of time encoded by the Starting Time IE in 3GPP TS 44.018 (32 024 frames).

NOTE 3: The value (k=0) should not be used, so as to leave time for the MS to analyse the message and get ready to receive or transmit.

## 12.22 (void)

## 12.23 Cell Identification

The *Cell Identification* information element is used to uniquely identify the cell.

**Table 12.23.1: Cell Identification information element**

< Cell Identification IE > ::=	
< Location Area Identification IE : octet (5) >	-- 3GPP TS 44.018
< RAC : bit (8) >	
< Cell Identity IE : octet (2) > ;	-- 3GPP TS 44.018



Table 12.23.2: *Cell Identification* information element details

<p><b>Location Area Identity IE</b> (5 octet field) This field is coded using the V format of the type 3 information element <i>Location Area Identification</i> defined in 3GPP TS 44.018.</p> <p><b>RAC</b> (8 bit field) This field is the binary representation of the Routing Area Code, see 3GPP TS 23.003.</p> <p><b>Cell Identity IE</b> (2 octet field) This field is coded using the V format of the type 3 information element <i>Cell Identity</i> defined in 3GPP TS 44.018.</p>
---

## 12.24 GPRS Cell Options

The *GPRS Cell Options* information element is used to control a set of cell options related to GPRS.

This information element may include a nested *Extension Bit* information element to allow future extension of cell option parameters.

Table 12.24.1: *GPRS Cell Options* information element

```

< GPRS Cell Options IE > ::=
  < NMO : bit (2) >
  < T3168 : bit (3) >
  < T3192 : bit (3) >
  < DRX_TIMER_MAX : bit (3) >
  < ACCESS_BURST_TYPE : bit >
  < CONTROL_ACK_TYPE : bit >
  < BS_CV_MAX : bit (4) >
  { 0 | 1 < PAN_DEC : bit (3) >
    < PAN_INC : bit (3) >
    < PAN_MAX : bit (3) > }
  -- Optional extension information:
  { 0 | 1 <Extension Length : bit (6)>
    < bit (val(Extension Length) + 1)
    & { <Extension Information > ! { bit ** = <no string> } } > } ;

< Extension Information > ::=
  { { -- R99 extension:
    { 0 | 1 - EGPRS supported by the cell if the choice bit is set to '1'
      < EGPRS_PACKET_CHANNEL_REQUEST : bit >
      < BEP_PERIOD : bit (4) > }
    < PFC_FEATURE_MODE : bit >
    < DTM_SUPPORT : bit >
    < BSS_PAGING_COORDINATION : bit > }
  { -- REL-4 extension:
    < CCN_ACTIVE : bit >
    < NW_EXT_UTBF : bit > }
  { -- REL 6 extension:
    < MULTIPLE_TBF_CAPABILITY : bit >
    < EXT_UTBF_NODATA : bit >
    < DTM_ENHANCEMENTS_CAPABILITY : bit >
    { 0 -- MBMS procedures not supported by the cell if the choice bit is set to '0'
      | 1 -- MBMS procedures supported by the cell if the choice bit is set to '1'
      < DEDICATED_MODE_MBMS_NOTIFICATION_SUPPORT : bit >
      < MNCI_SUPPORT : bit > } }
  { -- Rel-7 extension:
    < REDUCED_LATENCY_ACCESS : bit > }
  { -- Rel-10 extension:
    < NMO_I_ALTERNATE : bit > }
  < spare bit > ** } // ;
  -- Extension information may be truncated between released versions of the protocol.
  -- The receiver shall assume the value zero for any truncated bit.

```

Table 12.24.2: GPRS Cell Options information element details

<p><b>NMO</b> (2 bit field)</p> <p>This field is the binary representation of the Network Mode of Operation, see 3GPP TS 23.060:</p> <p>Bit</p> <table> <tr><td>2 1</td><td></td></tr> <tr><td>0 0</td><td>Network Mode of Operation I</td></tr> <tr><td>0 1</td><td>Network Mode of Operation II</td></tr> <tr><td>1 0</td><td>Network Mode of Operation III</td></tr> <tr><td>1 1</td><td>Reserved.</td></tr> </table>	2 1		0 0	Network Mode of Operation I	0 1	Network Mode of Operation II	1 0	Network Mode of Operation III	1 1	Reserved.								
2 1																		
0 0	Network Mode of Operation I																	
0 1	Network Mode of Operation II																	
1 0	Network Mode of Operation III																	
1 1	Reserved.																	
<p><b>T3168</b> (3 bit field)</p> <p>This field is the binary representation of the timeout value of timer T3168. Range: 0 to 7. The timeout value is given as the binary value plus one in units of 500 ms.</p>																		
<p><b>T3192</b> (3 bit field)</p> <p>This field is the binary representation of the timeout value of timer T3192. Range: 0 to 7. The timeout value is given in the following table. In the case of 0 ms, the timer is not started and the mobile station shall consider T3192 as immediately expiring and follow procedures defined in sub-clauses 9.3.2.6 and 9.3.3.5:</p> <p>Bit</p> <table> <tr><td>3 2 1</td><td></td></tr> <tr><td>0 0 0</td><td>500 ms</td></tr> <tr><td>0 0 1</td><td>1000 ms</td></tr> <tr><td>0 1 0</td><td>1500 ms</td></tr> <tr><td>0 1 1</td><td>0 ms</td></tr> <tr><td>1 0 0</td><td>80 ms</td></tr> <tr><td>1 0 1</td><td>120 ms</td></tr> <tr><td>1 1 0</td><td>160 ms</td></tr> <tr><td>1 1 1</td><td>200 ms</td></tr> </table>	3 2 1		0 0 0	500 ms	0 0 1	1000 ms	0 1 0	1500 ms	0 1 1	0 ms	1 0 0	80 ms	1 0 1	120 ms	1 1 0	160 ms	1 1 1	200 ms
3 2 1																		
0 0 0	500 ms																	
0 0 1	1000 ms																	
0 1 0	1500 ms																	
0 1 1	0 ms																	
1 0 0	80 ms																	
1 0 1	120 ms																	
1 1 0	160 ms																	
1 1 1	200 ms																	
<p><b>DRX_TIMER_MAX</b> (3 bit field)</p> <p>This field is the binary representation of the parameter DRX_TIMER_MAX. Range: 0 to 7. The parameter value is given as two taken to the power of the binary value minus one (<math>2^{(bv-1)}</math>) in units of 1 second. The binary value zero indicates the parameter value zero (i.e., the parameter takes the values: 0, 1 s, 2 s, 4 s, .. 64 s.)</p>																		
<p><b>ACCESS_BURST_TYPE</b> (1 bit field)</p> <p>The ACCESS_BURST_TYPE field indicates if the 8 or 11 bit format shall be used in the PACKET CHANNEL REQUEST message, the PS HANDOVER ACCESS message, the PTCCH uplink block (3GPP TS 44.004) and in the PACKET CONTROL ACKNOWLEDGMENT message when the format is four access bursts. The field is coded according to the following table:</p> <table> <tr><td>0</td><td>8-bit format shall be used</td></tr> <tr><td>1</td><td>11-bit format shall be used</td></tr> </table>	0	8-bit format shall be used	1	11-bit format shall be used														
0	8-bit format shall be used																	
1	11-bit format shall be used																	
<p><b>CONTROL_ACK_TYPE</b> (1 bit field)</p> <p>This field is the binary representation of the default format of the PACKET CONTROL ACKNOWLEDGMENT message:</p> <table> <tr><td>0</td><td>default format is four access bursts</td></tr> <tr><td>1</td><td>default format is RLC/MAC control block.</td></tr> </table>	0	default format is four access bursts	1	default format is RLC/MAC control block.														
0	default format is four access bursts																	
1	default format is RLC/MAC control block.																	
<p><b>BS_CV_MAX</b> (4 bit field)</p> <p>This field is the binary representation of the parameter BS_CV_MAX. Range: 0 to 15. The value BS_CV_MAX=0 shall be interpreted as value BS_CV_MAX=1 for calculation of T3200 and N3104max values.</p>																		
<p><b>PAN_DEC</b> (3 bit field)</p> <p>This field is the binary representation of the parameter PAN_DEC. If the field is not included, the default value 0 shall be used. Range: 0 to 7.</p>																		

<p><b>PAN_INC</b> (3 bit field) This field is the binary representation of the parameter PAN_INC. If the field is not included, the default value 0 shall be used. Range: 0 to 7.</p>
<p><b>PAN_MAX</b> (3 bit field) This field defines the maximum value allowed for counter N3102.</p> <p>bit 3 2 1 0 0 0 maximum value allowed for counter N3102 is 4 0 0 1 maximum value allowed for counter N3102 is 8 ... 1 1 1 maximum value allowed for counter N3102 is 32</p> <p>If the PAN_MAX field is not included, the default value 0 (i.e. N3102 max = 4) shall be used.</p>
<p><b>EGPRS_PACKET_CHANNEL_REQUEST</b> (1 bit field)</p> <p>0 EGPRS capable MSs shall use EGPRS PACKET CHANNEL REQUEST message for uplink TBF establishment on the PRACH when there is a PBCCH in the cell or on the RACH when there is no PBCCH in the cell.</p> <p>1 EGPRS capable MSs shall use two phase packet access with PACKET CHANNEL REQUEST message on the PRACH for uplink TBF establishment when there is a PBCCH in the cell. EGPRS capable MSs shall use two phase packet access with CHANNEL REQUEST message on the RACH when there is no PBCCH in the cell.</p>
<p><b>BEP_PERIOD</b> (4 bit field) This field is applicable in EGPRS TBF mode. For the definition of this field, refer to 3GPP TS 45.008.</p>
<p><b>PFC_FEATURE_MODE</b> (1 bit field)</p> <p>0 The network does not support packet flow context procedures. 1 The network supports packet flow context procedures.</p>
<p><b>DTM_SUPPORT</b> (1 bit field) This field indicates whether the cell supports DTM or not. It is coded as follows:</p> <p>0 The cell does not support DTM procedures. 1 The cell supports DTM procedures.</p>
<p><b>CCN_ACTIVE</b> (1 bit field) This field indicates whether CCN is enabled in the cell or not. It is coded as follows:</p> <p>0 CCN is disabled in the cell. 1 CCN is enabled in the cell.</p>
<p><b>NW_EXT_UTBF</b> (1 bit field) This field indicates whether the network supports the extended uplink TBF mode:</p> <p>0 The extended uplink TBF mode is not supported by the network. 1 The extended uplink TBF mode is supported by the network.</p>
<p><b>BSS_PAGING_COORDINATION</b> (1 bit field) This field indicates the network support of CS paging co-ordination in packet transfer mode during network mode of operation II and III. This field shall be ignored by the mobile station during network mode of operation I or by a mobile station capable of DTM in a cell supporting DTM procedures, in which cases Circuit-Switched paging coordination in packet transfer mode shall be provided by the network. It is coded as follows:</p> <p>0 The cell does not support Circuit-Switched paging coordination 1 The cell supports Circuit-Switched paging coordination</p>

<p><b>MULTIPLE_TBF_CAPABILITY</b> (1 bit field) This field indicates whether or not the cell supports multiple TBF procedures for A/Gb mode:</p> <ul style="list-style-type: none"><li>0 The cell does not support multiple TBF procedures.</li><li>1 The cell supports multiple TBF procedures.</li></ul>
<p><b>EXT_UTBF_NODATA</b> (1 bit field) This field indicates whether the mobile station during extended uplink TBF mode may refrain from sending PACKET UPLINK DUMMY CONTROL BLOCK messages when there is no other RLC/MAC block ready to send in an uplink radio block allocated by the network.</p> <ul style="list-style-type: none"><li>0 The mobile station shall send a PACKET UPLINK DUMMY CONTROL BLOCK message when there is no other RLC/MAC block ready to send in an uplink radio block allocated by the network.</li><li>1 The mobile station may refrain from sending a PACKET UPLINK DUMMY CONTROL BLOCK message when there is no other RLC/MAC block ready to send in an uplink radio block allocated by the network.</li></ul>
<p><b>DTM_ENHANCEMENTS_CAPABILITY</b> (1 bit field) This field indicates whether the cell supports enhanced DTM CS establishment and enhanced DTM CS release or not. It is coded as follows:</p> <ul style="list-style-type: none"><li>0 The cell does not support enhanced DTM CS establishment and enhanced DTM CS release procedures.</li><li>1 The cell supports enhanced DTM CS establishment and enhanced DTM CS release procedures.</li></ul>
<p><b>DEDICATED_MODE_MBMS_NOTIFICATION_SUPPORT</b> (1 bit field) This field indicates whether the cell supports Dedicated Mode MBMS Notification or not. It is coded as follows:</p> <ul style="list-style-type: none"><li>0 The cell does not support the Dedicated Mode MBMS Notification procedures.</li><li>1 The cell supports the Dedicated Mode MBMS Notification procedures.</li></ul>
<p><b>MNCI_SUPPORT</b> (1 bit field) This field indicates whether the cell supports the distribution of MBMS NEIGHBOURING CELL INFORMATION messages. It is coded as follows:</p> <ul style="list-style-type: none"><li>0 The cell does not support the distribution of MBMS NEIGHBOURING CELL INFORMATION messages</li><li>1 The cell supports the distribution of MBMS NEIGHBOURING CELL INFORMATION messages</li></ul>
<p><b>REDUCED_LATENCY_ACCESS</b> (1 bit field) This field indicates whether the cell supporting the EGPRS PACKET CHANNEL REQUEST message also supports "One Phase Access Request by Reduced Latency MS", see sub-clause 7.1.2.1.</p> <ul style="list-style-type: none"><li>0 The cell does not support "One Phase Access Request by Reduced Latency MS".</li><li>1 The cell supports "One Phase Access Request by Reduced Latency MS".</li></ul>
<p><b>NMO_I_ALTERNATE</b> (1 bit field) This field applies only to mobile stations which have the parameter 'NMO_I_Behaviour' set to the value of "1" in the NAS configuration Management Object as specified in 3GPP TS 24.368 [50] or in the USIM file NAS<sub>CONFIG</sub> as specified in 3GPP TS 31.102 [51] (the USIM file having priority if both parameters exist).</p> <ul style="list-style-type: none"><li>0 The mobile station shall use the Network Mode of Operation indicated in the NMO field.</li><li>1 The mobile station shall use Network Mode of Operation I irrespective of the value in the NMO field.</li></ul>

## 12.25 PCCCH Organization Parameters

The *PCCCH Organization Parameters* information element is used to control the organization of PCCCHs present in the cell. This information element contains general PCCCH organization parameters.

**Table 12.25.1: PCCCH Organization Parameters information element**

```
< PCCCH Organization Parameters IE > ::=
  < BS_PCC_REL : bit >
  < BS_PBCCH_BLKs : bit (2) >
  < BS_PAG_BLKs_RES : bit (4) >
  < BS_PRACH_BLKs : bit (4) >;
```

**Table 12.25.2: PCCCH Organization Parameters information element details**

### **BS\_PCC\_REL** (1 bit field)

The BS\_PCC\_REL field indicates if set = 1 that the last PDCH carrying PCCCH and PBCCH will be released shortly. All mobile stations on PCCCH shall then as soon as this information has been received return to CCCH and there obey the information sent on BCCH as specified in 3GPP TS 44.018. If the field is set = 0, no channel release is pending.

### **BS\_PBCCH\_BLKs** (2 bit field)

The BS\_PBCCH\_BLKs field indicates the number of blocks allocated to the PBCCH in the multiframe. The field is coded as the binary representation of BS\_PBCCH\_BLKs as defined in 3GPP TS 45.002 minus 1.

### **BS\_PAG\_BLKs\_RES** (4 bit field)

The BS\_PAG\_BLKs\_RES field indicates the number of blocks on each PDCH carrying the PCCCH per multiframe where neither PPCH nor PBCCH should appear. The field is coded as the binary representation of BS\_PAG\_BLKs\_RES as defined in 3GPP TS 45.002. Range: 0-10. The BS\_PAG\_BLKs\_RES value shall fulfil the condition that is defined in 3GPP TS 45.002. If the condition is not fulfilled, then the behaviour of the mobile station is implementation dependent.

### **BS\_PRACH\_BLKs** (4 bit field)

The BS\_PRACH\_BLKs field indicates the number of blocks reserved in a fixed way to the PRACH channel on any PDCH carrying PCCCH (see 3GPP TS 45.002). The field is coded as the binary representation of BS\_PRACH\_BLKs as defined in 3GPP TS 45.002. Range: 0-12. All other values are reserved and shall be interpreted as no Block reserved for PRACH.

## 12.26 Extension Bits IE

The *Extension Bits* information element is used to provide a generalized means for possible future extension within a message. This information element is variable length and contains the length indicator and spare bits.

**Table 12.26.1: Extension Bits information element**

```
< Extension Bits IE > ::=
  < extension length : bit (6) >
  < spare bit (val(extension length)+1) >;
```

## 12.27 Non GPRS Cell Options IE

The *Non GPRS Cell Options IE* is used to provide mobile stations operating in mode A or B with a repeated subset of BCCH information required for entering dedicated, group receive or group transmit mode.

**Table 12.27.1: Non GPRS Cell Options information element**

< Non GPRS Cell Options IE > ::=	
< ATT : bit >	-- Attach/Detach allowed
{ 0   1 < T3212 : bit (8) > }	-- Time-out value for periodic update
< NECI : bit >	-- Half rate support
< PWRC : bit >	-- Power Control indicator
< DTX : bit (2) >	-- DTX indicator
< RADIO-LINK-TIMEOUT : bit (4) >	-- Supervisory timer for RR connection
< BS-AG-BLKS-RES : bit (3) >	-- number of blocks reserved for access grant
< CCCH-CONF : bit (3) >	-- physical channel configuration for CCCH
< BS-PA-MFRMS : bit (3) >	-- number of 51 multiframe between transmission of paging messages
< MAX-RETRANS : bit (2) >	-- maximum number of retransmissions
< TX-INTEGGER : bit (4) >	-- number of slots to spread transmission
< EC : bit >	-- emergency call allowed
< MS-TXPWR-MAX-CCCH : bit (5) >	-- maximum Tx power level
-- Optional extension information:	
{ 0   1 < Extension Length : bit (6) >	
< bit (val(Extension Length) + 1)	
& { <Extension Information > ! { bit ** = <no string> } } > ;	
< Extension Information > ::=	
< ECSC : bit >	-- Early Classmark Sending Control
< 3G ECSR >	-- 3G Early Classmark Sending Restriction
< spare bit > ** ;	

**Table 12.27.2: Non GPRS Cell Options information element details**

For detailed descriptions of all elements see 3GPP TS 44.018.
If the optional T3212 parameter is not included, no periodic updating shall be performed.
<p><b>ECSC</b> (1 bit field) This field defines the Early Classmark Sending Control.</p> <p>0 Early Classmark Sending is forbidden 1 Early Classmark Sending is allowed</p> <p>If the optional ECSC parameter is not included, early classmark sending is allowed. For a detailed description see 3GPP TS 44.018.</p>
<p><b>3G ECSR</b> (1 bit field) This field defines the 3G Early Classmark Sending Restriction.</p> <p>0 Neither UTRAN nor cdma2000 classmark change message shall be sent with the Early Classmark Sending 1 The sending of UTRAN and CDMA2000 Classmark Sending messages is controlled by the Early Classmark Sending Control parameter</p> <p>If the optional 3G Early Classmark Sending Restriction parameter is not included, the default value '0' shall be assumed. For a detailed description see 3GPP TS 44.018.</p>

## 12.28 LSA Parameters

The *LSA Parameters* information element is used for cell reselection by SoLSA mobile stations. The IE contains a list of LSA\_ID(s) corresponding either to the entries in the 'Add Frequency list struct' defined in the Packet Cell Change Order message and in Packet Measurement Order message or to the entries in the Neighbour Cell Parameters when used in the packet System Information 3 and 3bis messages. Some entries in the 'LSA parameters IE' may be empty. In case there are too few entries in the 'LSA parameters IE', empty entries shall be added at the end. In case there are too many entries in the 'LSA parameters IE', the last shall be discarded.

**Table 12.28.1: LSA Parameters information element**

```
< LSA Parameters IE > ::=
  < NR_OF_FREQ_OR_CELLS : bit (5) >:
    { < LSA ID information : < LSA ID information struct >> * (val(NR_OF_FREQ_OR_CELLS)) };

< LSA ID information struct > ::=
  { 1 { 0 < LSA_ID : bit (24) >
    | 1 < ShortLSA_ID : bit (10) > } } ** 0 ;
```

**Table 12.28.2: LSA Parameters information element details**

### LSA\_ID (24 bit field)

The purpose of the LSA\_ID field is to identify a LSA. The LSA ID value field is coded as specified in 3GPP TS 23.003.

### Short LSA\_ID (10 bit field)

The purpose of the Short LSA\_ID field is to identify a LSA. The LSA ID defined by the Short LSA\_ID is a LSA\_ID as specified in 3GPP TS 23.003 with bit 0 set to "0" bit 1 to 10 set to the value of the Short LSA\_ID field (LSB in bit 1, MSB in bit 10) and bit 11 to 23 set to "0".

## 12.29 COMPACT reduced MA

**Table 12.29.1: COMPACT reduced MA information element**

```
< COMPACT reduced MA IE > ::=
  < Length of Reduced MA bitmap : bit (7) >
  < Reduced MA bitmap : bit( val( Length of Reduced MA bitmap ) ) >
  { 0 | 1 < MAIO_2 : bit(6) >};
```

**Table 12.29.2: COMPACT reduced MA information element details**

### Length of Reduced MA bitmap (7 bit field)

This field is the binary representation of the length (in bits) of the field Reduced MA bitmap.

If set to 0, then no reduced Mobile Allocation is used.

Range 0 to 127.

**Reduced MA bitmap** (bitmap)

This field gives the reduced Mobile Allocation.

This bitmap uses the list of frequencies given in the current Mobile Allocation, i.e. the Mobile Allocation used by the mobile for the assigned TBF. These radio frequency channels shall be arranged in the order of ascending ARFCN, except for ARFCN = 0, if included, which shall be put last.

The first bit position in the reduced MA bitmap corresponds to the last ARFCN put in the list, the last bit position corresponds to the first ARFCN put in the list. Each bit position is coded:

- 0 the corresponding radio frequency channel does not belong to the reduced MA;
- 1 the corresponding radio frequency channel belongs to the reduced MA.

**MAIO\_2** (6 bit field)

This field is present when a reduced MA is used, indicating more than one frequency.

This parameter is the binary representation of the mobile allocation index offset (MAIO) to be used on blocks using a reduced Mobile Allocation.

Range 0 to 63.

## 12.30 MS Radio Access Capability 2

The MS Radio Access Capability 2 information element is used to provide the radio part of the network with information concerning radio aspects of the mobile station. The contents may affect the manner in which the network handles the operation of the mobile station.

For the indication of the radio access capabilities the following conditions shall apply (see 3GPP TS 24.008 for the definition of the parameters):

- Among the three Access Technology Types GSM 900-P, GSM 900-E and GSM 900-R the MS shall include only one access technology type denoting the GSM 900 band it supports.
- Due to shared radio frequency channel numbers between GSM 1800 and GSM 1900, the mobile station should provide the relevant radio access capability for either GSM 1800 band OR GSM 1900 band, not both.
- One of two different coding forms shall be used by the mobile station when indicating its radio access capabilities to the network: the regular coding is where all capabilities are indicated explicitly within an *Access capabilities struct* for each signalled access technology and the alternative coding where access technologies with same capabilities are indicated within the *Additional access technologies struct* (see 3GPP TS 24.008).
- If the alternative coding by using the Additional access technologies struct is chosen by the mobile station, the mobile station shall indicate its radio access capability for the serving BCCH frequency band in the first included *Access capabilities struct* if this information element is not sent in response to an Access Technologies Request from the network or if none of the requested Access Technology Types is supported by the mobile station - see note 3. Otherwise, the mobile station shall include the radio access capabilities for the frequency bands it supports in the order of priority requested by the network as specified in sub-clause 7.1.3.2.
- If this information element is sent during a GPRS TBF establishment, the mobile station should indicate as many as possible of its supported Access Technology Types. The maximum number of indicated Access Technology Types depends on the remaining bits left in the RLC/MAC message containing the MS Radio Access Capability 2 IE. The radio access capability for the serving BCCH frequency band shall be part of the indicated technologies, the inclusion of any other radio access capability is a mobile station implementation option.
- If this information element is sent during an EGPRS TBF establishment, the mobile station shall indicate its supported Access Technology Types within the ones that are requested by the network or the access technology of the serving BCCH frequency band, as specified by the relevant procedures.
- If the first instance of radio access capabilities information for a supported access technology type fits in its entirety using the *Access capabilities struct* of the MS Radio Access Capability 2 IE sent within the PACKET RESOURCE REQUEST message, the mobile station may use the alternative coding for encoding other access technology types that are provided within either the PACKET RESOURCE REQUEST message or the ADDITIONAL MS RADIO ACCESS CAPABILITIES message. In the case where the ADDITIONAL MS



RADIO ACCESS CAPABILITIES message is sent to the network, the first Access Technology Type may be set to "1111".

- If message size limitations prevent the first instance of access capabilities information for a supported access technology type from being provided in its entirety using the *Access capabilities struct* of the MS Radio Access Capability 2 IE sent within the PACKET RESOURCE REQUEST message, the mobile station shall:
  - For this instance of access technology type, include as much of the access capabilities information as possible that can fit within the *Access capabilities struct* of the MS Radio Access Capability 2 IE sent within the PACKET RESOURCE REQUEST message. At minimum the mobile station shall provide up to and including its R99 access capabilities information within the *Access capabilities struct*. See note 1.
  - For this instance of access technology type, include the entire access capabilities information using the *Access capabilities struct* of the MS Radio Access Capability 2 IE sent within the ADDITIONAL MS RADIO ACCESS CAPABILITIES message (if this message is sent to the network). See note 2.

NOTE 1: The mobile station has to set the ADDITIONAL MS RAC INFORMATION AVAILABLE bit to 1 in the PACKET RESOURCE REQUEST message to signal that the instance of radio access capabilities provided in this message is incomplete - see sub-clauses 7.1.3.2 and 11.2.16.

NOTE 2: Additional instances of access capabilities information for other access technology types may be described using either the *Access capabilities struct* (regular coding) or the *Additional access technologies struct* (alternative coding).

NOTE 3: If the radio access capability for the serving BCCH frequency band has been included in its entirety in the PACKET RESOURCE REQUEST message, it should not be provided again in the ADDITIONAL MS RADIO ACCESS CAPABILITIES message, except in the cases specified in sub-clause 7.1.3.2.1 where this message is sent in response to a request from the network.

**Table 12.30.1: MS Radio Access Capability 2 information element**

```
< MS Radio Access Capability 2 IE > ::=
  < MS RA capability : < MS RA capability value part struct > > ;
```

**Table 12.30.2: MS Radio Access Capability 2 information element details**

**MS RA capability**

This information element is coded as defined by the *MS RA capability value part* defined in the *MS Radio Access Capability* IE defined in 3GPP TS 24.008. When this information element is sent, all spare bits shall be suppressed by the transmitter.

## 12.31 UTRAN FDD Target cell

The *UTRAN FDD Target cell* information element contains the description of a UTRAN FDD Target cell.

**Table 12.31.1: UTRAN FDD Target cell information element**

```
< UTRAN FDD Target cell IE > ::=
  < FDD-ARFCN : bit (14) >
  < Diversity : bit >
  { 0 | 1 < Bandwidth_FDD : bit (3) > }
  < SCRAMBLING_CODE : bit (9) > ;
```

**Table 12.31.2: UTRAN FDD Target cell information element details**

**FDD\_ARFCN (14 bit field)**

This information element is defined as the UARFCN in 3GPP TS 25.101.

<p><b>Diversity</b> (1 bit field) This parameter indicates if diversity is applied for the cell: Bit 0 Diversity is not applied for this cell 1 Diversity is applied for this cell.</p>
<p><b>Bandwidth_FDD</b> (3 bit field) This information element will be used for future releases. It shall not be sent in this version of the protocol. When missing, this indicates the present FDD bandwidth. When present, this shall not be considered as an error; indices of the 3G Neighbour Cell list shall be incremented accordingly.</p>
<p><b>Scrambling Codes</b> (9 bit field) This parameter indicates the Primary Scrambling Code as defined in 3GPP TS 25.331.</p>

## 12.32 UTRAN TDD Target cell

The *UTRAN TDD Target cell* information element contains the description of a UTRAN TDD Target cell.

**Table 12.32.1: UTRAN TDD Target cell information element**

<pre>&lt; UTRAN TDD Target cell IE &gt; ::=   &lt; TDD-ARFCN : bit (14) &gt;   &lt; Diversity TDD : bit &gt;   { 0   1 &lt; Bandwidth_TDD : bit (3) &gt; }   &lt; Cell Parameter : bit (7) &gt;   &lt; Sync Case TSTD : bit &gt; ;</pre>
--

**Table 12.32.2: UTRAN TDD Target cell information element details**

<p><b>TDD_ARFCN</b> (14 bit field) This information element is defined as the UARFCN in 3GPP TS 25.102.</p>
<p><b>Bandwidth_TDD</b> (3bit field) This information element refers to 3GPP TS 25.331. Bit 321 000 3.84Mcps 001 1.28Mcps All other values shall not be sent. All other values shall not be interpreted as an error; indices of the 3G Neighbour Cell list shall be incremented accordingly (but no reporting can be performed). When missing, this indicates 3,84 Mcps.</p>
<p><b>Diversity TDD</b> (1 bit field) This parameter indicates if SCTD (see 3GPP TS 25.224) is applied for the cell: Bit 0 SCTD is not applied for this cell 1 SCTD is applied for this cell.</p>
<p><b>Cell Parameter</b> (7 bit field) This parameter is defined in 3GPP TS 25.223.</p>

**Sync Case TSTD** (1 bit field)

For 3.84 Mcps TDD, this parameter is defined in 3GPP TS 25.223.

Bit

- 0 Sync Case 1
- 1 Sync Case 2

For 1.28 Mcps TDD, this parameter indicates if TSTD (see 3GPP TS 25.224) is applied for the cell:

Bit

- 0 TSTD is not applied for this cell
- 1 TSTD is applied for this cell.

## 12.33 Temporary Mobile Group Identity (TMGI)

The Temporary Mobile Group Identity (TMGI) identifies an MBMS service. The TMGI is defined in 3GPP TS 24.008.

The Temporary Mobile Group Identity information element always contains an MBMS SERVICE ID. In case the TMGI originates from another PLMN than the local one, the MCC (Mobile Country Code) and the MNC (Mobile Network Code) of that originating PLMN shall also be present.

**Table 12.33.1: TMGI information element**

```

< TMGI IE > ::=
  { 0                                     -- without MCC and MNC parameters
    < MBMS SERVICE ID : bit (24) >
  | 1                                     -- with MCC and MNC parameters
    < MBMS SERVICE ID : bit (24) >
    < MCC : bit (12) >
    < MNC : bit (12) > } ;

```

**Table 12.33.2: TMGI information element details**

**MBMS SERVICE ID** (24 bit field)

This field contains the identity of the MBMS service. The MBMS SERVICE ID is unique within a PLMN.

**MCC** (12 bit field)

This field contains the Mobile Country Code of the originating PLMN.

**MNC** (12 bit field)

This field contains the Mobile Network Code of the originating PLMN.

## 12.34 MBMS Bearer Identity

The MBMS Bearer Identity uniquely identifies an MBMS radio bearer on a PDCH.

**Table 12.34.1: MBMS Bearer Identity information element details**

<p><b>MBMS Bearer Identity</b> (1-5 bit field)</p> <p>The MBMS Bearer Identity field assigns a TFI value, or a subset of a TFI value, which identifies an MBMS radio bearer on a PDCH. In case only a subset of a TFI value is assigned for the MBMS radio bearer, that subset corresponds to the most significant bit(s) of the TFI field. The length of this field is defined by the value of the <i>Length of MBMS Bearer Identity</i> field, whose value is defined by a 3 bit field (range 1 to 5).</p> <p>The MBMS Bearer Identity field is encoded as a binary number.</p> <p>Range:</p> <p>1 bit field 0 to 1  2 bit field 0 to 3  3 bit field 0 to 7  4 bit field 0 to 15  5 bit field 0 to 31</p>
---

## 12.35 MS\_ID

The MS\_ID uniquely addresses a mobile station on an MBMS radio bearer with an assigned uplink feedback channel.

**Table 12.35.1: MS\_ID information element details**

<p><b>MS_ID</b> (1-4 bit field)</p> <p>An MS_ID is assigned to a mobile station for a given MBMS radio bearer with an uplink feedback channel. The length of the MS_ID field is defined by the value, increased by 1, of the <i>Length Indicator of MS_ID</i> field, whose value is defined by a 2 bit field (range 1 to 4). The sum of the length of the MBMS Bearer Identity field and of the length of the MS_ID field is equal to 5, i.e. the length of the TFI field.</p> <p>The MS_ID field is encoded as a binary number.</p> <p>Range:</p> <p>1 bit field 0 to 1  2 bit field 0 to 3  3 bit field 0 to 7  4 bit field 0 to 15</p>
---

## 12.36 MBMS Channel Parameters

The MBMS Channel Parameters contain various parameters applicable to one or more MBMS sessions.

**Table 12.36.1: MBMS Channel Parameters information element**

<pre>&lt; MBMS Channel Parameters IE &gt; ::=   { 0     { 0   1 &lt; MBMS p-t-m channel description : &lt; MBMS p-t-m channel description IE &gt; &gt;       &lt; MBMS Session Parameters List : &lt; MBMS Session Parameters List IE &gt;&gt; }       1       { 0   1 &lt; MPRACH description : &lt; MPRACH description IE &gt; &gt; } };     -- counting is off     -- counting is on</pre>
---

**Table 12.36.2: MBMS Channel Parameters information element details****MBMS p-t-m channel description**

This information element contains the MBMS p-t-m channel description of one or more MBMS sessions. This information element is defined in sub-clause 12.37.

**MBMS Session Parameters List**

This information element contains a list of MBMS Session Parameters to use on the MBMS p-t-m channel provided in the MBMS p-t-m channel description. Each entry in this list is associated with a notified MBMS session as identified in the MBMS Sessions List for this MBMS p-t-m channel. The n-th entry in the MBMS Session Parameters list corresponds to the n-th notified MBMS Session in the MBMS Sessions List. This information element is defined in sub-clause 12.40.

**MPRACH description**

This information element contains the description of the MPRACH on which the MBMS packet access procedure is initiated (see sub-clause 7.7.1). This information element is defined in sub-clause 12.38.

## 12.37 MBMS p-t-m channel description

The MBMS p-t-m channel description contains the p-t-m channel description for one or more MBMS sessions.

**Table 12.37.1: MBMS p-t-m channel description information element**

```
< MBMS p-t-m channel description IE > ::=
  { 0 | 1 < Frequency Parameters : < Frequency Parameters IE > > }
  < DL_TIMESLOT_ALLOCATION : bit (8) >;
```

**Table 12.37.2: MBMS p-t-m channel description information element details****Frequency Parameters**

If this information element is not present, the same frequency as for the PCCCH shall be used. This information element is defined in sub-clause 12.8.

**DL\_TIMESLOT\_ALLOCATION** (8 bit field)

This field is defined in sub-clause 12.18.

## 12.38 MPRACH description

The MPRACH description contains the MPRACH parameters to be used if MPRACH is indicated in an MBMS notification.

**Table 12.38.1: MPRACH description information element**

```
< MPRACH description IE > ::=
  { 0 | 1 < Frequency Parameters : < Frequency Parameters IE > > }
  < MPRACH_TIMESLOT_NUMBER : bit (3) >
  < USF : bit (3) >
  { 0 | 1 < MPRACH Control Parameters : < MPRACH Control Parameters IE > > } ;
```

**Table 12.38.2: MPRACH description information element details**

<p><b>Frequency Parameters</b> If this information element is not present, the same frequency as for the PCCCH shall be used. This information element is defined in sub-clause 12.8.</p>
<p><b>MPRACH_TIMESLOT NUMBER</b> (3 bit field) This field identifies the timeslot number of the PDCH where the MPRACH is located.</p>
<p><b>USF</b> (3 bit field) This field identifies the USF value that identifies the MPRACH on the defined PDCH.</p>
<p><b>MPRACH Control Parameters</b> This information element, if present, defines the access control parameters to be used on the MPRACH. This information element is defined in sub-clause 12.41.</p>

## 12.39 MBMS Sessions List

The MBMS Session List contains a list of MBMS sessions, identified by their TMGI, and if available MBMS Session Identity.

**Table 12.39.1: MBMS Sessions List information element**

<pre>&lt; MBMS Session List IE &gt; ::=   { 1 &lt; TMGI : &lt; TMGI IE &gt;&gt;     { 0   1 &lt; MBMS Session Identity : bit (8) &gt; } ** 0;</pre>
---

**Table 12.39.2: MBMS Sessions List information element**

<p><b>TMGI</b> This information element contains the Temporary Mobile Group Identity of an MBMS service. This information element is encoded as defined in sub-clause 12.33.</p>
<p><b>MBMS Session Identity</b> (8 bit field) This field contains the MBMS Session Identity of the concerned MBMS session.</p>

## 12.40 MBMS Session Parameters List

The MBMS Session Parameters List contains a list of MBMS Bearer IDs, Estimated Session Durations, MBMS Radio Bearer Starting Times, EGPRS Windows Sizes and NPM Transfer Times.

**Table 12.40.1: MBMS Session Parameters List information element**

<pre>&lt; MBMS Session Parameters List IE &gt; ::=   { 1 &lt; Length of MBMS Bearer Identity : bit (3) &gt; -- Configurations "000", "110" and "111" are reserved     &lt; MBMS Bearer Identity : bit (val (Length of MBMS Bearer Identity)) &gt;     &lt; Estimated Session Duration : bit (8) &gt;     { 0   1 &lt; MBMS Radio Bearer Starting Time : bit (16) &gt; }     { 0   1 &lt; EGPRS Window Size : &lt; EGPRS Window Size IE &gt;&gt; }     { 0   1 &lt; NPM Transfer Time : bit (5) &gt; } ** 0;</pre>
---

**Table 12.40.2: MBMS Session Parameters List information element details**

<p><b>Length of MBMS Bearer Identity</b> (3 bit field) This field indicates the length of the MBMS Bearer Identity for the concerned MBMS session. Any value from 1 to 5 inclusive is allowed. All other values are reserved.</p> <p><b>MBMS Bearer Identity</b> (1-5 bit field) This field contains the Bearer identity for the concerned MBMS session. This information element is defined in sub-clause 12.34.</p> <p><b>Estimated Session Duration</b> (8 bit field) This field contains an estimation of either the duration for the concerned MBMS session or, if the MBMS session is ongoing, the remaining duration for the concerned MBMS session. This information element is defined in sub-clause 12.44.</p> <p><b>MBMS Radio Bearer Starting Time</b> (16 bit field) This field contains a starting time that indicates the frame number from which the data transfer on the assigned MBMS radio bearer may start for the concerned MBMS session. The MBMS Radio Bearer Starting Time is encoded as the value part of the type 3 information element <i>Starting Time</i> in 3GPP TS 44.018.</p> <p><b>EGPRS Window Size</b> This information element defines the EGPRS Window Size for the concerned MBMS session and is defined in sub-clause 12.5.2.</p> <p><b>NPM Transfer Time</b> (5 bit field) This field defines the NPM Transfer Time limitation for the concerned MBMS session and is defined in sub-clause 12.45a.</p>
--

## 12.41 MPRACH Control Parameters

The purpose of the MPRACH Control Parameters information element is to provide parameters used to control the MPRACH utilization.

**Table 12.41.1: MPRACH Control Parameters information elements**

<pre>&lt; MPRACH Control Parameters IE &gt; ::=   { 0   1 &lt; ACC_CONTR_CLASS : bit (16) &gt; }   { 0   1 &lt; MAX_RETRANS : bit (2) &gt; }   &lt; S : bit (4) &gt;   { 0   1 &lt; TX_INT : bit (4) &gt; }   { 0   1 &lt; PERSISTENCE_LEVEL : bit (4) &gt; } ;</pre>
---

**Table 12.41.2: MPRACH Control Parameters information element details**

<p><b>TX_INT</b> (4 bit field) Number of slots to spread transmission of the random access. This information element is encoded as defined in sub-clause 12.14.</p>
<p><b>S</b> (4 bit field) S is a parameter used for calculation of the minimum number of slots between two successive Channel request messages. This information element is encoded as defined in sub-clause 12.14.</p>
<p><b>MAX_RETRANS</b> (2 bit field) Indicates the maximum number of retransmissions allowed. This information element is encoded as defined in sub-clause 12.14.</p>

**PERSISTENCE\_LEVEL** (4 bit field)

The PERSISTENCE\_LEVEL field indicates the values of the access persistence level. This information element is encoded as defined in sub-clause 12.14.

**ACC\_CONTR\_CLASS** ( 16 bit field)

Access Control Class N (bit 1-16) (see octet 3 and 4 of the RACH Control Parameters IE in 3GPP TS 44.018) . This information element is encoded as defined in sub-clause 12.14.

## 12.42 PS Handover Radio Resources

This information element provides the radio resources assigned for PS services in the new cell and is included within the PS HANDOVER COMMAND message.



Table 12.42.1: PS Handover Radio Resources information element

```

< PS Handover Radio Resources IE > ::=
  { 0 | 1 < Handover Reference : bit (8) > }
  < ARFCN : bit (10) >
  < SI : bit (2) >
  < NCI : bit (1) >
  < BSIC : bit (6) >
  { 0 | 1 < CCN_ACTIVE : bit (1) > }
  { 0 | 1 < 3G_CCN_ACTIVE : bit (1) > }
  { 0 | 1 < CCN Support Description : < CCN Support Description struct >> }
  < Frequency Parameters : < Frequency Parameters IE >>
  < NETWORK_CONTROL_ORDER : bit (2) >
  { 0 | 1 < Global Packet Timing Advance : < Global Packet Timing Advance IE >> }
    { 0 | 1 < Packet Extended Timing Advance : bit (2) > } } -- Only used in uplink
  < EXTENDED_DYNAMIC_ALLOCATION : bit (1) > -- Only used in uplink
  < RLC_RESET : bit (1) >
  { 0 | 1 < P0 : bit (4) > }
    < PR_MODE : bit (1) > }
  { 0 | 1 < Uplink Control Timeslot : bit (3) > }
  { 0 < GPRS mode : < GPRS mode struct >> }
  | 1 < EGPRS mode : < EGPRS mode struct >> } ;

< CCN Support Description struct > ::=
  < Number_Cells : bit (7) >
  { CCN_SUPPORTED : bit } * (val(Number_Cells)) ;

< GPRS mode struct > ::=
  -- Uplink TBFs
  { { 0 | 1 < CHANNEL_CODING_COMMAND : bit (2) > }
    { 0 | 1 < Global Timeslot description : < Timeslot description struct >> }
    { 1 < Uplink Assignment : < Uplink TBF Assignment struct >> } ** 0 }
  -- Downlink TBFs
  { 1 < Downlink Assignment : < Downlink Assignment struct >> } ** 0 ;

< EGPRS mode struct > ::=
  -- Uplink TBFs
  { { 0 | 1 < EGPRS Window Size : < EGPRS Window Size IE >> }
    { 0 | 1 < EGPRS Channel Coding Command : < EGPRS Modulation and Coding Scheme IE >> }
    { 0 | 1 < BEP_PERIOD2 : bit(4) > }
    { 0 | 1 < Global Timeslot description : < Timeslot description struct >> }
    { 1 < Uplink Assignment : < Uplink TBF Assignment struct >> } ** 0 }
  -- Downlink TBFs
  { 0 | 1
    { 0 | 1 { 0 | 1 < EGPRS Window Size : < EGPRS Window Size IE >> }
      < LINK_QUALITY_MEASUREMENT_MODE : bit (2) >
      { 0 | 1 < BEP_PERIOD2 : bit(4) > } }
    { 1 < Downlink Assignment : < Downlink Assignment struct >> } ** 0 } ;

```

```

< Uplink TBF Assignment struct > ::=                -- Recursive for multiple TBFs
{ 0 | 1 < PFI : bit (7) > }-
< RLC_MODE : bit (1) >
< TFI Assignment : bit (5) >
{ 0 | 1 < CHANNEL_CODING_COMMAND : bit (2) > }
{ 0 | 1 < EGPRS Channel Coding Command : < EGPRS Modulation and Coding Scheme IE > > }
{ 0 | 1 < EGPRS Window Size : < EGPRS Window Size IE > > }
< USF_GRANULARITY : bit (1) >
{ 0
-- The timeslots assigned to the TBF are all the timeslots assigned
-- in the Global Timeslot description
| 1 < TBF_TIMESLOT_ALLOCATION : bit (N) > } -- The timeslots assigned to the TBF are a subset of all the
-- timeslots assigned in the Global Timeslot description. Where
-- N is the number of timeslots assigned to the MS in the Global
-- Timeslot description

{ 0 < USF_ALLOCATION : bit (3) > -- The same USF is valid on all timeslots assigned to the TBF
| 1 -- Different USF(s) assigned
< USF_ALLOCATION : bit (3) > -- USF assignment on the lowest numbered timeslot
-- assigned to the TBF
{ 0 | 1 < USF_ALLOCATION : bit (3) > } * (M-1) ; -- USFs on subsequent timeslots assigned to the TBF:
-- A "0" (respectively a "1" followed by a USF value)
-- means same (respectively different) USF value as the
-- USF on the next lower numbered timeslot assigned to
-- the TBF. Where M is the amount of timeslots assigned
-- to the TBF in the TBF_TIMESLOT_ALLOCATION if
-- present, else in the Global Timeslot description.

< Downlink Assignment struct > ::= -- Recursive for multiple TBFs
< TIMESLOT_ALLOCATION : bit (8) >
{ < Downlink TBF assignment : < Downlink TBF assignment struct > > } ;

< Downlink TBF assignment struct > ::=
{ 0 | 1 < PFI : bit (7) > }
< RLC_MODE : bit (1) >
< TFI Assignment : bit (5) >
< CONTROL_ACK : bit (1) >
{ 0 | 1 < EGPRS Window Size : < EGPRS Window Size IE > > } ;

< Timeslot description struct > ::=
{ 0 -- without power control params
< MS_TIMESLOT_ALLOCATION : bit (8) >
| 1 -- with power control params
< ALPHA : bit (4) >
{ 0 | 1 < GAMMA_TN0 : bit (5) > }
{ 0 | 1 < GAMMA_TN1 : bit (5) > }
{ 0 | 1 < GAMMA_TN2 : bit (5) > }
{ 0 | 1 < GAMMA_TN3 : bit (5) > }
{ 0 | 1 < GAMMA_TN4 : bit (5) > }
{ 0 | 1 < GAMMA_TN5 : bit (5) > }
{ 0 | 1 < GAMMA_TN6 : bit (5) > }
{ 0 | 1 < GAMMA_TN7 : bit (5) > } } ;

```

Table 12.42.2: PS Handover Radio Resources information element details

**Handover Reference** (8 bit field)

This field contains the reference value to be used when performing PS Handover. The field is encoded as the contents of the Handover Reference information element as defined in 3GPP TS 44.018.

<p><b>SI</b> (2 bit field) The Synchronization Indication (SI) field indicates which type of PS Handover is to be performed.</p> <p>Bit 2 1 0 0 Non-synchronized 0 1 Synchronized 1 0 Pre-synchronised 1 1 reserved</p>
<p><b>NCI</b> (1 bit field) The Normal Cell Indication (NCI) field indicates how the MS shall behave in case of out of range timing advance values.</p> <p>Bit 1 0 Out of range timing advance is ignored 1 Out of range timing advance shall trigger a handover failure procedure.</p>
<p><b>ARFCN</b> (10 bit field) This field contains the BCCH frequency of the new cell. This field is encoded as the ARFCN defined in 3GPP TS 44.018. Range: 0 to 1023.</p>
<p><b>BSIC</b> (6 bit field) This field contains the BSIC of the new cell. The BSIC field is coded as the "Base Station Identity Code" defined in 3GPP TS 23.003.</p>
<p><b>CCN_ACTIVE</b> (1 bit field) For description and encoding, see the Packet Cell Change Order message.</p>
<p><b>3G_CCN_ACTIVE</b> (1 bit field) For description and encoding, see the Packet Cell Change Order message.</p>
<p><b>CCN Support Description</b></p> <p><b>CCN_SUPPORTED</b> (1 bit field) For description and encoding, see the Packet Cell Change Order message.</p>
<p><b>Frequency Parameters</b> This information element is defined in sub-clause 12.8.</p>
<p><b>EXTENDED_DYNAMIC_ALLOCATION</b> (1 bit field) For description and encoding, see the Multiple TBF Uplink Assignment message.</p>
<p><b>NETWORK_CONTROL_ORDER</b> (2 bit field) For description and encoding, see the Packet Measurement Order message.</p>
<p><b>P0</b> (4 bit field) For description and encoding, see the Multiple TBF Uplink Assignment message.</p>
<p><b>PR_MODE</b> (1 bit field) For description and encoding, see the Multiple TBF Uplink Assignment message.</p>
<p><b>Global Packet Timing Advance</b> This information element is defined in sub-clause 12.12a</p>

<p><b>RLC_RESET</b> (1 bit field)</p> <p>This information element indicates whether or not all RLC entities used to support the given TBFs in the old cell shall be reset to support the TBFs allocated for the corresponding PFCs in the new cell:</p> <p>0 RLC is not reset (the RLC state machines are maintained across PS handover)  1 RLC is reset (the RLC state machines are not maintained across PS handover)</p> <p>If this field is set to '1', then after successful completion of the PS Handover procedure, the mobile shall consider all TBFs which were ongoing when the PS Handover Command message was received to have been implicitly released.</p>
<p><b>Packet Extended Timing Advance</b> (2 bit field)</p> <p>This field is defined in sub-clause 12.12b.</p>
<p><b>Uplink Control Timeslot</b> (3 bit field)</p> <p>For description and encoding, see the Multiple TBF Uplink Assignment message.</p>
<p><b>CHANNEL_CODING_COMMAND</b> (2 bit field)</p> <p>For description and encoding, see the Multiple TBF Uplink Assignment message.</p>
<p><b>EGPRS Window Size</b></p> <p>This information element is defined in sub-clause 12.5.2.</p>
<p><b>EGPRS Modulation and Coding Scheme</b></p> <p>For description and encoding, see the Multiple TBF Uplink Assignment message.</p>
<p><b>BEP_PERIOD2</b> (4 bit field)</p> <p>For description and encoding, see the Multiple TBF Uplink Assignment message.</p>
<p><b>LINK_QUALITY_MEASUREMENT_MODE</b> (2 bit field)</p> <p>For description and encoding, see the Multiple TBF Downlink Assignment message.</p>
<p><b>PFI</b> (7 bit field)</p> <p>This field shall only be included for TBFs if both the network and the mobile station support multiple TBFs. This field contains the PFI parameter identifying a Packet Flow Context. The PFI parameter is encoded as the contents of the PFI information element as defined in 3GPP TS 44.01</p>
<p><b>TFI Assignment</b> (5 bit field)</p> <p>For description and encoding, see the Multiple TBF Uplink Assignment message.</p>
<p><b>USF_GRANULARITY</b> (1 bit field)</p> <p>For description and encoding, see the Multiple TBF Uplink Assignment message.</p>
<p><b>TBF_TIMESLOT_ALLOCATION</b> (N bit field)</p> <p>For description and encoding, see the Multiple TBF Uplink Assignment message.</p>
<p><b>USF_ALLOCATION</b> (3 bit field)</p> <p>For description and encoding, see the Multiple TBF Uplink Assignment message.</p>
<p><b>RLC_MODE</b> (1 bit field)</p> <p>For description and encoding, see the Multiple TBF Uplink Assignment message or the Multiple TBF Downlink Assignment message. If the <b>RLC_RESET</b> field indicates that any given RLC entity is not reset across PS handover then the mobile station shall ignore this field and use the same RLC mode that was used for the corresponding PFC in the old cell.</p>
<p><b>CONTROL_ACK</b> (1 bit field)</p> <p>If the <b>RLC_RESET</b> field indicates that RLC entities are reset, this field shall be set to '0'.  If multiple TBFs are supported by both network and mobile station and the <b>RLC_RESET</b> field indicates that RLC entities are not reset, this field shall be coded as specified for the Multiple TBF Downlink Assignment message.  If either the network or the mobile station does not support the multiple TBF feature and the <b>RLC_RESET</b> field indicates that RLC entities are not reset, this field shall be set to '1' if the network establishes a new downlink TBF for the mobile station whose timer T3192 is running. Otherwise this field shall be set to '0'.</p>

<p><b>TIMESLOT_ALLOCATION</b> (8 bit field) For description and encoding, see the Multiple TBF Downlink Assignment message.</p>
<p><b>MS_TIMESLOT_ALLOCATION</b> (8 bit field) For description and encoding, see the Multiple TBF Uplink Assignment message. As the explicit power control parameters are omitted for the allocated timeslots in the new cell, the mobile station shall use the default values (see 3GPP TS 45.008) for the power control parameters.</p>
<p><b>ALPHA</b> (4 bit field) For encoding and description see the Global Power Control Parameters IE.</p>
<p><b>GAMMA_TN</b> (5 bit field) For description and encoding, see the Multiple TBF Uplink Assignment message.</p>
<p><b>NPM Transfer Time</b> (5 bit field) This field contains the NPM Transfer Time limitation in case of RLC non-persistent mode.</p> <p>The list of NPM Transfer Time IEs in the Rel-7 additions is ordered as described by the loops in the earlier releases part.</p>
<p><b>EVENT_BASED_FANR</b> (1 bit field) For description and encoding, see the Multiple TBF Downlink Assignment message.</p>
<p><b>REPORTED_TIMESLOTS</b> (8 bit field) For description and encoding, see the Multiple TBF Downlink Assignment message.</p>
<p><b>TSH</b> (2 bit field) For description and encoding, see the Multiple TBF Downlink Assignment message.</p>

## 12.42a PS Handover Radio Resources 2

This information element provides the radio resources assigned for PS services for a dual carrier configuration or where the PS resources require the support of EGPRS2, Fast Ack/Nack Reporting or RTTI configurations in the new cell and is included within the PS HANDOVER COMMAND message.

Table 12.42a.1: PS Handover Radio Resources 2 information element

```

< PS Handover Radio Resources 2 IE > ::=
  { 0 | 1 < Handover Reference : bit (8) > }
  < ARFCN : bit (10) >
  < SI : bit (2) >
  < NCI : bit (1) >
  < BSIC : bit (6) >
  { 0 | 1 < CCN_ACTIVE : bit (1) > }
  { 0 | 1 < 3G_CCN_ACTIVE : bit (1) > }
  { 0 | 1 < CCN Support Description : < CCN Support Description struct >> }
  { 01
    -- Legacy IEs used
    < Frequency Parameters C1 : < Frequency Parameters IE >>
    { 0 | 1 < Frequency Parameters C2 : < Frequency Parameters IE >> }
  | 10
    -- Optimized Dual Carrier frequency parameters used
    < Dual Carrier Frequency Parameters : < Dual Carrier Frequency Parameters IE >>
  ! < Frequency Parameters error: { 00 | 11 } bit(*) = < no string >> } -- reserved for future use
  < NETWORK_CONTROL_ORDER : bit (2) >
  { 0 | 1 < Global Packet Timing Advance : < Global Packet Timing Advance IE >>
    { 0 | 1 < Packet Extended Timing Advance : bit (2) > } } -- Only used in uplink
  < RLC_RESET : bit (1) >
  < EGPRS mode : < EGPRS mode 2 IE >>

  -- Optional extension information:
  { 0 | 1 < Extension Length : bit (6) >
    < bit (val(Extension Length) + 1)
      & { < Extension Information > ! { bit ** = < no string > } } > } ;

< CCN Support Description struct > ::=
  < Number_Cells : bit (7) >
  { CCN_SUPPORTED : bit } * (val(Number_Cells)) ;

< Extension Information > ::=
  -- Additions for REL-9
  { 0 | 1 MTTI_DOWNLINK_ASSIGNMENT_C1 : bit (1) }
  { 0 | 1 MTTI_DOWNLINK_ASSIGNMENT_C2 : bit (1) }
  { 0 | 1 MTTI_UPLINK_ASSIGNMENT_C1 : bit (1) }
  { 0 | 1 MTTI_UPLINK_ASSIGNMENT_C2 : bit (1) }
  -- Additions for REL-11
  { < EGPRS Packet Downlink Ack/Nack Type 3 Support : bit (1) > }
  < spare bit > ** // ;
  -- Extension information may be truncated between released versions of the protocol.
  -- The receiver shall assume the value zero for any truncated bit.

```

Table 12.42a.2: PS Handover Radio Resources 2 information element details

<b>Handover Reference</b> (8 bit field)
This field contains the reference value to be used when performing PS Handover. The field is encoded as the contents of the Handover Reference information element as defined in 3GPP TS 44.018.
<b>ARFCN</b> (10 bit field)
This field contains the BCCH frequency of the new cell. This field is encoded as the ARFCN defined in 3GPP TS 44.018.
Range: 0 to 1023.
<b>SI</b> (2 bit field)
The Synchronization Indication (SI) field indicates which type of PS Handover is to be performed.
Bit
2 1
0 0 Non-synchronized
0 1 Synchronized
1 0 Pre-synchronised
1 1 reserved

<p><b>NCI</b> (1 bit field) The Normal Cell Indication (NCI) field indicates how the MS shall behave in case of out of range timing advance values.</p> <p>Bit</p> <p>1</p> <p>0 Out of range timing advance is ignored</p> <p>1 Out of range timing advance shall trigger a handover failure procedure.</p>
<p><b>BSIC</b> (6 bit field) This field contains the BSIC of the new cell. The BSIC field is coded as the "Base Station Identity Code" defined in 3GPP TS 23.003.</p>
<p><b>CCN_ACTIVE</b> (1 bit field) For description and encoding, see the Packet Cell Change Order message.</p>
<p><b>3G_CCN_ACTIVE</b> (1 bit field) For description and encoding, see the Packet Cell Change Order message.</p>
<p><b>CCN Support Description</b></p> <p><b>CCN_SUPPORTED</b> (1 bit field) For description and encoding, see the Packet Cell Change Order message.</p>
<p><b>Frequency Parameters C1</b> This information element is defined in sub-clause 12.8.</p> <p><b>Frequency Parameters C2</b> This information element is defined in sub-clause 12.8.</p> <p><b>Dual Carrier Frequency Parameters</b> This information element is defined in sub-clause 12.8.2.</p>
<p><b>NETWORK_CONTROL_ORDER</b> (2 bit field) For description and encoding, see the Packet Measurement Order message.</p>
<p><b>Global Packet Timing Advance</b> This information element is defined in sub-clause 12.12a</p>
<p><b>Packet Extended Timing Advance</b> (2 bit field) This field is defined in sub-clause 12.12b.</p>
<p><b>RLC_RESET</b> (1 bit field) This field is defined in sub-clause 12.42.</p>
<p><b>EGPRS mode 2 IE</b> This information element is defined in sub-clause 12.48a.1.</p>
<p><b>MTTI_DOWNLINK_ASSIGNMENT_C1</b> (1 bit field) <b>MTTI_DOWNLINK_ASSIGNMENT_C2</b> (1 bit field) See sub-clause 11.2.7 (Packet Downlink Assignment message).</p>
<p><b>MTTI_UPLINK_ASSIGNMENT_C1</b> (1 bit field) <b>MTTI_UPLINK_ASSIGNMENT_C2</b> (1 bit field) See sub-clause 11.2.29 (Packet Uplink Assignment message).</p>
<p><b>EGPRS Packet Downlink Ack/Nack Type 3 Support</b> (1 bit field) See sub-clause 11.2.7 (Packet Downlink Assignment message).</p>

## 12.42b PS Handover Radio Resources 3

This information element provides the radio resources assigned for PS services for a DLMC configuration in the new cell and is included within the PS HANDOVER COMMAND message.



Table 12.42b.1: PS Handover Radio Resources 3 information element

```

< PS Handover Radio Resources 3 IE > ::=
{ 0 | 1 < Handover Reference : bit (8) > }
< SI : bit (2) >
< NCI : bit (1) >
< BSIC : bit (6) >
{ 0 | 1 < CCN_ACTIVE : bit (1) > }
{ 0 | 1 < 3G_CCN_ACTIVE : bit (1) > }
{ 0 | 1 < CCN Support Description : < CCN Support Description struct >> }
{
  < DOWNLINK_RLC_MODE : bit (1) >
  < CONTROL_ACK : bit (1) >
  { 1 < UFPS : < UFPS struct >> } ** 0
  DLMC Measurement Type : bit (1)
  < LINK_QUALITY_MEASUREMENT_MODE : bit (2) >
  { 0 | 1 < Carrier < Global Packet Timing Advance : < Global Packet Timing Advance IE > > }
  { 0 | 1 < Packet Extended Timing Advance : bit (2) > }
  { 0 | 1 < PTCCH_CARRIER : bit (4) > }
  < PDAN Coding : bit (1) >
  < Extended SNS : bit (1) >
  { 0 | 1 < BEP_PERIOD2 : bit(4) > }
  { 0 | 1 < PFI of downlink TBF : bit (7) > }
  { 0 | 1 < Downlink NPM Transfer Time : bit (5) > }
  { 0 | 1 -- '1' indicates Fast Ack/Nack Reporting is activated for downlink TBF
    < EVENT_BASED_FANR : bit (1) > }
  < Downlink EGPRS Level: < EGPRS Level IE >>
  < Indication of Upper Layer PDU Start for RLC UM : bit >
  < EGPRS Packet Downlink Ack/Nack Type 3 Support : bit(1) >
  < EGPRS Channel Coding Command : < EGPRS Modulation and Coding Scheme IE >> }
{
  < RESEGMENT : bit (1) >
  { 1 << DLMC UL Carrier Info : < DLMC UL Carrier Info struct >> } ** 0
  { 0 | 1 < UPLINK EGPRS Window Size : < EGPRS Window Size IE >> }
  < UPLINK_TFI_ASSIGNMENT : bit (5) >
  { 0 | 1 < PFI of uplink TBF : bit (7) > }
  { 0 | 1 < UPLINK_RLC_MODE : bit (1) > }
  { 0 | 1 < Uplink NPM Transfer Time : bit (5) > }
  { 0 | 1 -- '1' indicates that FANR is activated
    { 0 -- SSN-based encoding is selected
      | 1 -- Time-based encoding is selected
    }
    < REPORTED_TIMESLOTS : bit (8) >
    < TSH : bit (2) > } }
  < Uplink EGPRS Level: < EGPRS Level IE >>
  { 0 | 1 < Pulse Format: < Pulse Format IE >> }
  { 0 | 1 < Uplink Control Timeslot : bit (3) > } }
< NETWORK_CONTROL_ORDER : bit (2) >
< RLC_RESET : bit (1) >;

< CCN Support Description struct > ::=
< Number_Cells : bit (7) >
{ CCN_SUPPORTED : bit } * (val(Number_Cells));

```

```

< UFPS struct > ::=
{ 00      -- Existing UFPS released
  | 01      -- Existing UFPS remains unchanged (no information provided)
  | 10      -- Existing UFPS changed/new UFPS provided
    { 0      -- Existing DLFC Frequency Parameters unchanged
      | 1 < DLFC Frequency Parameters : < DLFC Frequency Parameters IE > > }
    { 1 < CARRIER_SPECIFIC_INFO : < Carrier Specific Info struct > > } ** 0
  | 11 bit (*) = < no string >      -- Reserved
};

< Carrier Specific Info struct > ::=
{ 00      -- Existing carrier released
  | 01      -- Existing carrier remains unchanged (no information provided)
  | 10      -- Existing carrier changed/new carrier provided
    { 0      -- BTTI mode
      { 0      -- same timeslots as the lowest numbered carrier
        | 1 < TIMESLOT_ALLOCATION : bit (8) > }
      | 1      -- RTTI mode
        { 0      -- same PDCH-pairs as the lowest numbered carrier
          | 1 < DOWNLINK_PDCH_PAIRS_DLFC : bit (8) >
            < RTTI_DOWNLINK_PDCH_PAIR_ASSIGNMENT_DLFC : bit (4) > }
        }
      { 0 | 1 < MAIO : bit (6) > }
      { 0      -- same P0 and PR_MODE as the lowest numbered carrier
        | 1 < P0 : bit (4) >
          < PR_MODE : bit (1) > }
      { 0      -- same DOWNLINK_TFI_ASSIGNMENT as the lowest numbered carrier
        | 1 < DOWNLINK_TFI_ASSIGNMENT : bit (5) >
          { 0 | 1 < DOWNLINK_eTFI_ASSIGNMENT : bit (3) > } }
      { 0      -- same Power Control Parameters as the lowest numbered carrier
        | 1 < Power Control Parameters : < Power Control Parameters IE > > }
      { 0      -- EMST is not used on this carrier
        | 1 -- EMST is used on this carrier
          < RLC Entity 2 : < RLC Entity Struct > >
          { 0 | 1 < DOWNLINK_eTFI_ASSIGNMENT : bit (3) > }
          { 0 | 1 < RLC Entity 3 : < RLC Entity Struct > >
            { 0 | 1 < DOWNLINK_eTFI_ASSIGNMENT : bit (3) > } }
      { 0      -- EMSR is not used on this carrier
        | 1 -- EMSR is used on this carrier
          { 1 < EMSR Additional PFCs 1 : < Additional PFCs struct > >
            { 0 | 1 < DOWNLINK_eTFI_ASSIGNMENT : bit (3) > } } ** 0
          { 1 < EMSR Additional PFCs 2 : < Additional PFCs struct > >
            { 0 | 1 < DOWNLINK_eTFI_ASSIGNMENT : bit (3) > } } ** 0
          { 1 < EMSR Additional PFCs 3 : < Additional PFCs struct > >
            { 0 | 1 < DOWNLINK_eTFI_ASSIGNMENT : bit (3) > } } ** 0
          }
          < Primary TSC Set : bit (1) >
          { 0 | 1      -- Secondary DL TSC Value assigned
            < Secondary DL TSC Set : bit (1) >
            < Secondary DL TSC Value : bit (3) > }
    | 11 bit (*) = < no string >      -- Reserved
};

< DLFC UL Carrier Info struct > ::=
{ 00      -- Assigned carrier released
  | 01      -- Carrier remains unchanged (no information provided)
  | 10      -- Assigned carrier modified or new carrier assigned
    { 0      -- BTTI mode
      { 0 | 1 < UPLINK_TIMESLOT_ALLOCATION : bit (8) > }      -- assigned PDCH
      | 1      -- RTTI mode
        { 0 | 1 < UPLINK_PDCH_PAIRS_DLFC : bit (8) > }      -- assigned PDCH-pairs
      }
    < Dynamic Allocation 3 : < Dynamic Allocation 3 IE > >
    { 0      -- EMST is not used on this carrier
      | 1 -- EMST is used on this carrier
        < Uplink RLC Entity 2 : < RLC Entity Struct > >
        { 0 | 1 < Uplink RLC Entity 3 : < RLC Entity Struct > > }
    { 0      -- EMSR is not used on this carrier
      | 1 -- EMSR is used on this carrier
        { 1 < EMSR Additional PFCs 1 : < Additional PFCs struct > > } ** 0
        { 1 < EMSR Additional PFCs 2 : < Additional PFCs struct > > } ** 0
        { 1 < EMSR Additional PFCs 3 : < Additional PFCs struct > > } ** 0
      }
    }

```

**Table 12.42b.2: PS Handover Radio Resources 3 information element details**

<p><b>Handover Reference</b> (8 bit field) This field contains the reference value to be used when performing PS Handover. The field is encoded as the contents of the Handover Reference information element as defined in 3GPP TS 44.018.</p>
<p><b>SI</b> (2 bit field) The Synchronization Indication (SI) field indicates which type of PS Handover is to be performed.</p> <p>Bit 2 1 0 0 Non-synchronized 0 1 Synchronized 1 0 Pre-synchronised 1 1 reserved</p>
<p><b>NCI</b> (1 bit field) The Normal Cell Indication (NCI) field indicates how the MS shall behave in case of out of range timing advance values.</p> <p>Bit 1 0 Out of range timing advance is ignored 1 Out of range timing advance shall trigger a handover failure procedure.</p>
<p><b>BSIC</b> (6 bit field) This field contains the BSIC of the new cell. The BSIC field is coded as the "Base Station Identity Code" defined in 3GPP TS 23.003.</p>
<p><b>CCN_ACTIVE</b> (1 bit field) This field is defined in sub-clause 11.2.4.</p>
<p><b>3G_CCN_ACTIVE</b> (1 bit field) This field is defined in sub-clause 11.2.4.</p>
<p><b>CCN Support Description</b></p> <p><b>CCN_SUPPORTED</b> (1 bit field) This field is defined in sub-clause 11.2.4.</p>
<p><b>DOWNLINK_RLC_MODE</b> (1 bit field) <b>UPLINK_RLC_MODE</b> (1 bit field) This field is defined in sub-clause 11.2.31.</p>
<p><b>CONTROL_ACK</b> (1 bit field) See sub-clause 11.2.7 (Packet Downlink Assignment message).</p>
<p><b>NETWORK_CONTROL_ORDER</b> (2 bit field) This field is defined in sub-clause 11.2.9b.</p>
<p><b>Global Packet Timing Advance</b> This information element is defined in sub-clause 12.12a</p>
<p><b>Packet Extended Timing Advance</b> (2 bit field) This field is defined in sub-clause 12.12b.</p>
<p><b>RLC_RESET</b> (1 bit field) This field is defined in sub-clause 12.42.</p>

<p><b>UFPS</b> This information element is used to identify the set of resources corresponding to each UFPS within the set of UFPS assigned for a DLMC configuration in the new cell. Each UFPS in the set of UFPS is numbered according to the scheme described in sub-clause 8.1.1.1.3.</p>
<p><b>DLMC Measurement Type</b> See sub-clause 11.2.7.</p>
<p>See sub-clause 11.2.7.</p>
<p><b>UPLINK EGPRS Window Size</b></p> <p><b>EGPRS Window Size</b> This field is defined in sub-clause 12.5.2.</p>
<p><b>LINK_QUALITY_MEASUREMENT_MODE</b> (2 bit field) This field is defined in sub-clause 11.2.7.</p>
<p><b>BEP_PERIOD2</b> (4 bit field) This field is defined in sub-clause 11.2.7.</p>
<p><b>PFI of downlink TBF</b> (7 bit field) <b>PFI of uplink TBF</b> (7 bit field) This field is defined in sub-clause 11.2.31.</p>
<p><b>Downlink NPM Transfer Time</b> (5 bit field) <b>Uplink NPM Transfer Time</b> (5 bit field) This field is defined in sub-clause 11.2.31.</p>
<p><b>EVENT_BASED_FANR</b> (1 bit field) This field is defined in sub-clause 11.2.31.</p>
<p><b>Uplink EGPRS Level</b> (2 bit field) <b>Downlink EGPRS Level</b> (2 bit field) These fields assign the group of modulation and coding schemes applicable to the uplink and downlink TBFs respectively and is defined in sub-clause 12.10f.</p>
<p><b>Indication of Upper Layer PDU Start for RLC UM</b> (1 bit field) This field is defined in section 11.2.7.</p>
<p><b>EGPRS Packet Downlink Ack/Nack Type 3 Support</b> (1 bit field) See sub-clause 11.2.7.</p>
<p><b>EGPRS Modulation and Coding Scheme</b> This field is defined in sub-clause 12.10d. If this field is included in a Multi Carrier assignment, it shall specify the initial EGPRS Modulation and Coding Scheme to be used on all assigned carriers.</p>
<p><b>CARRIER_SPECIFIC_INFO</b> See sub-clause 11.2.7.</p>
<p><b>DLMC Frequency Parameters</b> See sub-clause 11.2.7.</p>
<p><b>DOWNLINK_TIMESLOT_ALLOCATION</b> (8 bit field) <b>UPLINK_TIMESLOT_ALLOCATION</b> (8 bit field) This field is defined in sub-clause 12.18.</p>
<p><b>DOWNLINK_PDCH_PAIRS_DLMC</b> <b>UPLINK_PDCH_PAIRS_DLMC</b> This field is defined in sub-clause 11.2.31.</p>

<p><b>RTTI_DOWNLINK_PDCH_PAIR_ASSIGNMENT_DLMC</b> This field is defined in sub-clause 11.2.31.</p>
<p><b>MAIO</b> (6 bit field) See sub-clause 11.2.7.</p>
<p><b>P0</b> (4 bit field) See sub-clause 11.2.7.</p>
<p><b>PR_MODE</b> (1 bit field) See sub-clause 11.2.7.</p>
<p><b>DOWNLINK_TFI_ASSIGNMENT</b> (5 bit field) See sub-clause 11.2.7.</p>
<p><b>UPLINK_TFI_ASSIGNMENT</b> (5 bit field) See sub-clause 11.2.29.</p>
<p><b>Power Control Parameters</b> See sub-clause 11.2.7.</p>
<p><b>DLMC UL Carrier Info</b> See sub-clause 11.2.29.</p>
<p><b>REPORTED TIMESLOTS</b> This field is defined in sub-clause 11.2.31.</p>
<p><b>TSH</b> (2 bit field) This field is defined in sub-clause 11.2.31.</p>
<p><b>Pulse Format</b> (N bits field) This information element, if assigned, specified on which radio frequency channel the mobile station shall transmit using the narrow-band pulse option. The information element is defined in sub-clause 12.8.3.</p>
<p><b>Uplink Control Timeslot</b> (3 bit field) This field is defined in sub-clause 11.2.29.</p>
<p><b>Dynamic Allocation 3</b> This field is defined in sub-clause 11.2.29.</p>
<p><b>PTCCH_CARRIER</b> (4 bit field) See sub-clause 11.2.7.</p>
<p><b>PDAN Coding</b> (1 bit field) See sub-clause 11.2.7.</p>
<p><b>DOWNLINK_eTFI_ASSIGNMENT</b> (3 bit field) See sub-clause 11.2.7.</p>
<p><b>Extended SNS</b> (1 bit field) See sub-clause 11.2.7.</p>
<p><b>EMSR Additional PFCs 1</b> <b>EMSR Additional PFCs 2</b> <b>EMSR Additional PFCs 3</b> These IEs are defined in section 11.2.7.</p>

<p><b>Primary TSC Set</b> (1 bit field) See sub-clause 11.2.7 and 11.2.29.</p>
<p><b>Secondary DL TSC Set</b> (1 bit field) See sub-clause 11.2.7.</p>
<p><b>Secondary DL TSC Value</b> (3 bit field) See sub-clause 11.2.7.</p>

## 12.43 NAS Container for PS Handover

The purpose of the NAS Container for PS Handover information element (see Note 1) is to indicate the layer 3 information to be applied by the mobile station upon successful completion of PS handover or DTM handover to A/Gb mode.

**Table 12.43.1: NAS Container for PS Handover information element**

<pre>&lt; NAS Container for PS Handover IE &gt; ::=   &lt; NAS_CONTAINER_LENGTH : bit (7) &gt;   &lt; NAS_CONTAINER_DATA : octet (val(NAS_CONTAINER_LENGTH)) &gt;   &lt; padding bits &gt; ;</pre>
--

**Table 12.43.2: NAS Container for PS Handover information element details**

<p><b>NAS_CONTAINER_DATA</b> (N octet field) This contents of this information element is identical to the value part of the <i>NAS Container for PS Handover</i> information element described in 3GPP TS 24.008 where N is the length of the value part of the <i>NAS Container for PS Handover</i> information element.</p>
--

## 12.44 Estimated Session Duration

The Estimated Session Duration gives an estimation of the (remaining) duration for the MBMS session. The initial value is derived from the payload in the *MBMS Session Duration* IE (see 3GPP TS 48.018), rounded up to the next higher value that can be signalled with the coding provided in Table 12.44.1. Any subsequent value for the remaining duration of the MBMS session is derived from the initial value, unless an up-to-date value is available in the *MBMS Session Duration* IE.

**Table 12.44.1: Estimated Session Duration information element details**

<p><b>Estimated Session Duration</b> (8 bit field) The Estimated Session Duration information element is coded as follows:</p>
<pre>bit 8 7 6 5 4 3 2 1 0 0 0 0 0 0 0 0  5 seconds 0 0 0 0 0 0 0 1  10 seconds ...                in 5s step 0 0 0 0 1 0 1 1  1 minute 0 0 0 0 1 1 0 0  1 minute 10 seconds ...                in 10s step 0 0 1 0 0 0 1 1  5 minutes 0 0 1 0 0 1 0 0  5 minutes 30 seconds ...                in 30s step 0 0 1 0 1 1 0 1  10 minutes 0 0 1 0 1 1 1 0  11 minutes</pre>

...	<i>in 1m step</i>
0 1 0 1 1 1 1 1	1 hour
0 1 1 0 0 0 0 0	1 hour 5 minutes
...	<i>in 5m step</i>
1 0 0 0 1 1 1 1	5 hours
1 0 0 1 0 0 0 0	5 hours 15 minutes
...	<i>in 15m step</i>
1 0 1 0 0 0 1 1	10 hours
1 0 1 0 0 1 0 0	10 hours 30 minutes
...	<i>in 30m step</i>
1 0 1 1 1 1 1 1	1 day
1 1 0 0 0 0 0 0	1 day 3 hours
...	<i>in 3h step</i>
1 1 1 0 1 1 1 1	7 days
1 1 1 1 0 0 0 0	7 days 12 hours
...	<i>in 12h step</i>
1 1 1 1 0 1 0 1	10 days
1 1 1 1 0 1 1 0	11 days
...	<i>in 1 day step</i>
1 1 1 1 1 1 0 1	18days
1 1 1 1 1 1 1 0	19 days
1 1 1 1 1 1 1 1	>19 days

## 12.45 MBMS In-band Signalling Indicator

The MBMS In-band Signalling Indicator indicates whether the network sends system information messages and (for mobile stations with an assigned MS\_ID on that MBMS radio bearer) paging messages on the PACCH.

**Table 12.45.1: MBMS In-band Signalling Indicator information elements**

< MBMS In-band Signalling Indicator IE > ::= < <b>MBMS In-band Signalling Indicator</b> : bit (1) >;
---

**Table 12.45.2: MBMS In-band Signalling Indicator information element details**

### **MBMS In-band Signalling Indicator** (1 bit field)

The MBMS In-band Signalling Indicator information element is coded as follows:

Bit	
0	System information and paging messages are not sent on the PACCH of the MBMS radio bearer.
1	System information and paging messages are sent on the PACCH of the MBMS radio bearer.

## 12.45a NPM Transfer Time

This information element defines the NPM Transfer Time limitation in case of RLC non-persistent mode and is derived from the Transfer Delay IE defined in 3GPP TS 24.008.

Table 12.45a.1: NPM Transfer Time Information Elements details

bit 5 4 3 2 1	NPM Transfer Time (in ms)
0 0 0 0 0	30
0 0 0 0 1	40
0 0 0 1 0	50
0 0 0 1 1	60
0 0 1 0 0	70
0 0 1 0 1	80
0 0 1 1 0	90
0 0 1 1 1	100
0 1 0 0 0	125
0 1 0 0 1	150
0 1 0 1 0	175
0 1 0 1 1	200
0 1 1 0 0	225
0 1 1 0 1	250
0 1 1 1 0	275
0 1 1 1 1	300
1 0 0 0 0	400
1 0 0 0 1	500
1 0 0 1 0	600
1 0 0 1 1	700
1 0 1 0 0	800
1 0 1 0 1	900
1 0 1 1 0	1000
1 0 1 1 1	1500
1 1 0 0 0	2000
1 1 0 0 1	2500
1 1 0 1 0	3000
1 1 0 1 1	3500
1 1 1 0 0	4000
1 1 1 0 1	4500
1 1 1 1 0	5000
1 1 1 1 1	Reserved

## 12.45b RRC Container

The RRC Container is used to contain an RRC message (e.g. HANDOVER TO UTRAN COMMAND or *DL-DCCH-Message* including a *RRCConnectionReconfiguration*) as defined in 3GPP TS 25.331[20] or 3GPP TS 36.331[45].

Table 12.45b.1: RRC Container information element

```

< RRC Container IE > ::=
  < RRC_CONTAINER_LENGTH : bit (8) >
  < RRC_CONTAINER_DATA : octet (val(RRC_CONTAINER_LENGTH)) >
  < padding bits > ;

```

Table 12.45b.2: RRC Container information element details

**RRC\_CONTAINER\_LENGTH** (8 bit field)  
This field indicates the number of octets in the RRC\_CONTAINER\_DATA.

bit	
8 7 6 5 4 3 2 1	
0 0 0 0 0 0 0 0	reserved for future use;
0 0 0 0 0 0 0 1	RRC_CONTAINER_DATA length = 1 octet;
0 0 0 0 0 0 1 0	RRC_CONTAINER_DATA length = 2 octets;
....	
1 1 1 1 1 1 1 1	RRC_CONTAINER_DATA length = 255 octets;



**RRC\_CONTAINER\_DATA** (N octet field)

This field contains an RRC Container as specified in 3GPP TS 25.331 [20] or as specified in 3GPP TS36.331 [45].

## 12.46 DTM Handover PS Radio Resources

This information element provides the radio resources assigned for PS services in the new cell and is included within the DTM HANDOVER COMMAND message.

Table 12.46.1: DTM Handover PS Radio Resources information element

```

< DTM Handover PS Radio Resources IE > ::=
  < Cell Identification : < Cell Identification IE > >           --- provided by SI/PSI for PS HO
  < MAX_LAPDm : bit (3) >                                     --- needed for DTM in new cell
  < GPRS_MS_TXPWR_MAX_CCH : bit (5) >                         --- needed for DTM in new cell
  < GPRS Cell Options : < GPRS Cell Options IE > >           --- provided by SI/PSI for PS HO
  < GPRS Power Control Parameters : < GPRS Power Control Parameters IE > > --- provided by SI/PSI for PS HO
  < EXTENDED_DYNAMIC_ALLOCATION : bit (1) >                   --- only used in uplink
  < RLC_RESET : bit (1) >
  { 0 | 1 < P0 : bit (4) >
    < PR_MODE : bit (1) > }
  { 0 | 1 < Uplink Control Timeslot : bit (3) > }
  { 0 < GPRS mode : GPRS mode struct > >
    | 1 < EGPRS mode : EGPRS mode struct > > }
  { null | 0 bit** = < no string > -- Receiver backward compatible with earlier version
    | 1 -- Additions for Rel-12
      { 0 | 1 -- Primary TSC Value assigned
        < Primary TSC Set : bit (1) >
        < Primary TSC Value : bit (3) > }
      { 0 | 1 -- Secondary DL TSC Value assigned
        < Secondary DL TSC Set : bit (1) >
        < Secondary DL TSC Value : bit (3) > }
    < padding bits > } ; -- truncation at end of message allowed, bits '0' assumed

< GPRS mode struct > ::=
  -- Uplink TBFs
  { { 0 | 1 < CHANNEL_CODING_COMMAND : bit (2) > }
    { 0 | 1 < Global Timeslot description : < Timeslot description struct > >
      { 1 < Uplink Assignment : < Uplink TBF Assignment struct > > } ** 0 } }
  -- Downlink TBFs
  { 1 < Downlink Assignment : < Downlink Assignment struct > > } ** 0 ;

< EGPRS mode struct > ::=
  -- Uplink TBFs
  { { 0 | 1 < EGPRS Window Size : < EGPRS Window Size IE > > }
    { 0 | 1 < EGPRS Channel Coding Command : < EGPRS Modulation and Coding Scheme IE > > }
    { 0 | 1 < BEP_PERIOD2 : bit(4) > }
    { 0 | 1 < Global Timeslot description : < Timeslot description struct > >
      { 1 < Uplink Assignment : < Uplink TBF Assignment struct > > } ** 0 } }
  -- Downlink TBFs
  { 0 | 1
    { 0 | 1 { 0 | 1 < EGPRS Window Size : < EGPRS Window Size IE > > }
      < LINK_QUALITY_MEASUREMENT_MODE : bit (2) >
      { 0 | 1 < BEP_PERIOD2 : bit(4) > } }
    { 1 < Downlink Assignment : < Downlink Assignment struct > > } ** 0 } ;

```

```

< Uplink TBF Assignment struct > ::=
    { 0 | 1 < PFI : bit (7) > }-
    < RLC_MODE : bit (1) >
    < TFI Assignment : bit (5) >
    { 0 | 1 < CHANNEL_CODING_COMMAND : bit (2) > }
    { 0 | 1 < EGPRS Channel Coding Command : < EGPRS Modulation and Coding Scheme IE > > }
    { 0 | 1 < EGPRS Window Size : < EGPRS Window Size IE > > }
    < USF_GRANULARITY : bit (1) >
    { 0
        -- The timeslots assigned to the TBF are all the timeslots assigned
        -- in the Global Timeslot description
    | 1 < TBF_TIMESLOT_ALLOCATION : bit (N) > }
        -- The timeslots assigned to the TBF are a subset of all the
        -- timeslots assigned in the Global Timeslot description. Where
        -- N is the number of timeslots assigned to the MS in the Global
        -- Timeslot description

    { 0 < USF_ALLOCATION : bit (3) >
    | 1
        < USF_ALLOCATION : bit (3) >
        -- USF assignment on the lowest numbered timeslot
        -- assigned to the TBF
        { 0 | 1 < USF_ALLOCATION : bit (3) > } * (M-1) } ;
        -- USFs on subsequent timeslots assigned to the TBF:
        -- A "0" (respectively a "1" followed by a USF value)
        -- means same (respectively different) USF value as the
        -- USF on the next lower numbered timeslot assigned to
        -- the TBF. Where M is the amount of timeslots assigned
        -- to the TBF in the TBF_TIMESLOT_ALLOCATION if
        -- present, else in the Global Timeslot description.

< Downlink Assignment struct > ::=
    -- Recursive for multiple TBFs
    < TIMESLOT_ALLOCATION : bit (8) >
    { < Downlink TBF assignment : < Downlink TBF assignment struct > > } ;

< Downlink TBF assignment struct > ::=
    { 0 | 1 < PFI : bit (7) > }-
    < RLC_MODE : bit (1) >
    < TFI Assignment : bit (5) >
    < CONTROL_ACK : bit (1) >
    { 0 | 1 < EGPRS Window Size : < EGPRS Window Size IE > > } ;

< Timeslot description struct > ::=
    { 0
        -- without power control params
    < MS_TIMESLOT_ALLOCATION : bit (8) >
    | 1
        -- with power control params
        < ALPHA : bit (4) >
        { 0 | 1 < GAMMA_TN0 : bit (5) > }
        { 0 | 1 < GAMMA_TN1 : bit (5) > }
        { 0 | 1 < GAMMA_TN2 : bit (5) > }
        { 0 | 1 < GAMMA_TN3 : bit (5) > }
        { 0 | 1 < GAMMA_TN4 : bit (5) > }
        { 0 | 1 < GAMMA_TN5 : bit (5) > }
        { 0 | 1 < GAMMA_TN6 : bit (5) > }
        { 0 | 1 < GAMMA_TN7 : bit (5) > } } ;

```

Table 12.46.2: DTM Handover PS Radio Resources information element details

<b>Cell Identification</b> (information element) This information element is defined in sub-clause 12.23.
<b>MAX_LAPDm</b> (3 bit field) This field indicates the maximum number of LAPDm frames on which a layer 3 can be segmented into and be sent on the main DCCH. It is coded as described in 3GPP TS 44.018.
<b>GPRS_MS_TXPWR_MAX_CCH</b> (5 bit field) The GPRS_MS_TXPWR_MAX_CCH field is coded as the binary representation of the 'power control level' in 3GPP TS 45.005 corresponding to the maximum TX power level a mobile station may use when accessing on a packet control channel. This value shall be used by the mobile station according to 3GPP TS 45.008.

<p><b>GPRS Cell Options</b> (information element) The GPRS Cell Option information element is defined in sub-clause 12.24.</p>
<p><b>GPRS Power Control Parameters</b> (information element) The GPRS Power Control Parameters information element is defined in sub-clause 12.9a.</p>
<p><b>EXTENDED_DYNAMIC_ALLOCATION</b> (1 bit field) For description and encoding, see the Multiple TBF Uplink Assignment message.</p>
<p><b>RLC_RESET</b> (1 bit field) For description and encoding, see sub-clause 12.42.</p>
<p><b>P0</b> (4 bit field) For description and encoding, see the Multiple TBF Uplink Assignment message.</p>
<p><b>PR_MODE</b> (1 bit field) For description and encoding, see the Multiple TBF Uplink Assignment message.</p>
<p><b>Uplink Control Timeslot</b> (3 bit field) For description and encoding, see the Multiple TBF Uplink Assignment message.</p>
<p><b>CHANNEL_CODING_COMMAND</b> (2 bit field) For description and encoding, see the Multiple TBF Uplink Assignment message.</p>
<p><b>EGPRS Window Size</b> This information element is defined in sub-clause 12.5.2.</p>
<p><b>EGPRS Modulation and Coding Scheme</b> For description and encoding, see the Multiple TBF Uplink Assignment message.</p>
<p><b>BEP_PERIOD2</b> (4 bit field) For description and encoding, see the Multiple TBF Uplink Assignment message.</p>
<p><b>LINK_QUALITY_MEASUREMENT_MODE</b> (2 bit field) For description and encoding, see the Multiple TBF Downlink Assignment message.</p>
<p><b>PFI</b> (7 bit field) This field shall only be included for TBFs if both the network and the mobile station support multiple TBFs. This field contains the PFI parameter identifying a Packet Flow Context. The PFI parameter is encoded as the contents of the PFI information element as defined in 3GPP TS 44.018.</p>
<p><b>RLC_MODE (1 bit field)</b> For description and encoding, see the Multiple TBF Uplink Assignment message or the Multiple TBF Downlink Assignment message. If the <b>RLC_RESET</b> field indicates that any given RLC entity is not reset across PS handover then the mobile station shall ignore this field and use the same RLC mode that was used for the corresponding PFC in the old cell.</p>
<p><b>TFI Assignment</b> (5 bit field) For description and encoding, see the Multiple TBF Uplink Assignment message.</p>
<p><b>USF_GRANULARITY</b> (1 bit field) For description and encoding, see the Multiple TBF Uplink Assignment message.</p>
<p><b>TBF_TIMESLOT_ALLOCATION</b> (N bit field) For description and encoding, see the Multiple TBF Uplink Assignment message.</p>
<p><b>USF_ALLOCATION</b> (3 bit field) For description and encoding, see the Multiple TBF Uplink Assignment message.</p>
<p><b>TIMESLOT_ALLOCATION</b> (8 bit field) For description and encoding, see the Multiple TBF Downlink Assignment message.</p>

<p><b>CONTROL_ACK</b> (1 bit field) For description and encoding, see sub-clause 12.42.</p>
<p><b>MS_TIMESLOT_ALLOCATION</b> (8 bit field) For description and encoding, see the Multiple TBF Uplink Assignment message.</p>
<p><b>ALPHA</b> (4 bit field) For encoding and description see the Global Power Control Parameters IE.</p>
<p><b>GAMMA_TN</b> (5 bit field) For description and encoding, see the Multiple TBF Uplink Assignment message.</p>
<p><b>Primary TSC Set</b> (1 bit field) If a mobile station supports the extended TSC sets (see 3GPP TS 45.002 [32]) then it shall use this field to identify the TSC set associated with the <i>Primary TSC Value</i> field. In the absence of this field the TSC set indicated by the <i>DTM Handover CS Radio Resources</i> IE shall be used.</p> <p><b>Secondary DL TSC Set</b> (1 bit field) If a mobile station supports the extended TSC sets (see 3GPP TS 45.002 [32]) then it shall use this field to identify the TSC set associated with the <i>Secondary DL TSC Value</i> field.</p> <p>The Primary TSC Set and Secondary DL TSC Set fields are coded as follows:</p> <p>0 TSC set 1</p> <p>1 Indicates TSC set 2 for 8PSK, 16QAM and 32QAM modulation. For GMSK modulation it indicates TSC set 3 (which is identical to TSC set 3 used for the CS domain).</p>
<p><b>Primary TSC Value</b> (3 bit field) If a mobile station supports the extended TSC sets (see 3GPP TS 45.002 [32]) then it shall use this field to identify the primary TSC value to be used on the assigned uplink and downlink PS resources. In the absence of this field the TSC value indicated by the <i>DTM Handover CS Radio Resources</i> IE shall be used as the Primary TSC value. It is coded as the binary representation of the Training Sequence code as defined in 3GPP TS 45.002. Range: 0 to 7.</p>
<p><b>Secondary DL TSC Value</b> (3 bit field) If a mobile station supports the extended TSC sets (see 3GPP TS 45.002 [32]) then it shall use this field to identify the secondary TSC value to be used on the assigned downlink PS resources. It is coded as the binary representation of the Training Sequence code as defined in 3GPP TS 45.002. Range: 0 to 7.</p>

## 12.47 DTM Handover CS Radio Resources

This information element provides the radio resources assigned for CS service in the new cell and is included within the DTM HANDOVER COMMAND message.

**Table 12.47.1: DTM Handover CS Radio Resources information element**

<pre> &lt; CS Handover Radio Resources IE &gt; ::=   &lt; CS_HANDOVER_RADIO_RESOURCES_LENGTH : bit (7) &gt;   &lt; CS_HANDOVER_RADIO_RESOURCES_DATA : octet (val(CS_HANDOVER_RADIO_RESOURCES_LENGTH)) &gt;   &lt; padding bits &gt; ; </pre>
--

**Table 12.47.2: DTM Handover CS Radio Resources information element details**

<b>CS_HANDOVER_RADIO_RESOURCES_LENGTH</b> (7 bit field)	
This field indicates the number of CS_HANDOVER_RADIO_RESOURCES_DATA octets included in the CS Handover Radio Resources IE .	
bit	
7 6 5 4 3 2 1	
0 0 0 0 0 0 0	No CS_HANDOVER_RADIO_RESOURCES_DATA follows; Spare padding is used to fill the rest of the message;
0 0 0 0 0 0 1	CS_HANDOVER_RADIO_RESOURCES_DATA length = 1 octet;
0 0 0 0 0 1 0	CS_HANDOVER_RADIO_RESOURCES_DATA length = 2 octets;
....	
1 1 1 1 1 1 1	CS_HANDOVER_RADIO_RESOURCES_DATA length = 127 octets;
<b>CS_HANDOVER_RADIO_RESOURCES_DATA</b> (N octet field)	
The contents of this information element are identical to the contents of the HANDOVER COMMAND (see 3GPP TS 44.018) except for the <i>RR management Protocol Discriminator</i> IE, the <i>Skip Indicator</i> IE and the <i>Handover Command Message Type</i> IE which are not included. N is the combined length of the information elements from the HANDOVER COMMAND that are included within this IE.	

## 12.48 DTM Handover PS Radio Resources 2

This information element provides the radio resources assigned for PS services in the new cell and is included within the DTM HANDOVER COMMAND message.

NOTE: The maximum length (64 bits) of the *Extension Information* IE as defined in the present sub-clause may constrain the information that can be included in this IE.

Table 12.48.1: DTM Handover PS Radio Resources 2 information element

```

< DTM Handover PS Radio Resources 2 IE > ::=
  < Cell Identification : < Cell Identification IE > >           --- provided by SI/PSI for PS HO
  < MAX_LAPDm : bit (3) >                                     --- needed for DTM in new cell
  < GPRS_MS_TXPWR_MAX_CCH : bit (5) >                       --- needed for DTM in new cell
  < GPRS Cell Options : < GPRS Cell Options IE > >         --- provided by SI/PSI for PS HO
  < GPRS Power Control Parameters : < GPRS Power Control Parameters IE > > --- provided by SI/PSI for PS HO
  < RLC_RESET : bit (1) >
  { 00 < EGPRS mode : < EGPRS mode 2 IE > >
  ! < TBF mode error: { 01 | 10 | 11 } bit(*) = < no string > > } -- reserved for future use

  -- Optional extension information:
  { 0 | 1 < Extension Length : bit (6) >
    < bit (val(Extension Length) + 1)
    & { < Extension Information > ! { bit ** = < no string > } } > };

< Extension Information > ::=
  { {
    -- Rel-9 extension:
    { 0 < EMST_NW_Capability : bit (1) >   -- EMST is not used
      | 1                                   -- EMST is used
      { 0
        | 1 < Downlink RLC Entity 2 : < RLC Entity struct >
          { 0
            | 1 < Downlink RLC Entity 3 : < RLC Entity struct >
          }
        }
      { 0
        | 1 < Uplink RLC Entity 2 : < RLC Entity struct >
          { 0
            | 1 < Uplink RLC Entity 3 : < RLC Entity struct >
          }
        }
      }
    }
    { 0 | 1 MTTI_DOWNLINK_ASSIGNMENT_C1 : bit (1) }
    { 0 | 1 MTTI_DOWNLINK_ASSIGNMENT_C2 : bit (1) }
    { 0 | 1 MTTI_UPLINK_ASSIGNMENT_C1 : bit(1) }
    { 0 | 1 MTTI_UPLINK_ASSIGNMENT_C2 : bit(1) }
  }
  {
    -- Rel-11 extension:
    < EGPRS Packet Downlink Ack/Nack Type 3 Support : bit(1) >
  }
  {
    -- Rel-12 extension:
    { 0 | 1   -- Primary DL TSC Value assigned
      < Primary TSC Set : bit (1) >
      < Primary TSC Value : bit (3) > }
    { 0 | 1   -- Secondary DL TSC Value assigned
      < Secondary DL TSC Set : bit (1) >
      < Secondary DL TSC Value : bit (3) > }
  }
  < spare bit > ** } // ;
  -- Extension information may be truncated between released versions of the protocol.
  -- The receiver shall assume the value zero for any truncated bit.

< RLC Entity struct > ::=
  < TFI : bit (5) >
  < RLC_MODE : bit (1) >
  { 0 | 1 < EGPRS Window Size : < EGPRS Window Size IE > > }
  < PFI : bit (7) >;

```

Table 12.48.2: DTM Handover PS Radio Resources 2 information element details

<p><b>Cell Identification</b> (information element) This information element is defined in sub-clause 12.23.</p>
<p><b>MAX_LAPDm</b> (3 bit field) This field indicates the maximum number of LAPDm frames into which a layer 3 message can be segmented sent on the main DCCH. It is coded as described in 3GPP TS 44.018.</p>

<p><b>GPRS_MS_TXPWR_MAX_CCH</b> (5 bit field) The GPRS_MS_TXPWR_MAX_CCH field is coded as the binary representation of the 'power control level' in 3GPP TS 45.005 corresponding to the maximum TX power level a mobile station may use when accessing on a packet control channel. This value shall be used by the mobile station according to 3GPP TS 45.008.</p>
<p><b>GPRS Cell Options</b> (information element) The GPRS Cell Option information element is defined in sub-clause 12.24.</p>
<p><b>GPRS Power Control Parameters</b> (information element) The GPRS Power Control Parameters information element is defined in sub-clause 12.9a.</p>
<p><b>RLC_RESET</b> (1 bit field) This field is defined in sub-clause 12.42.</p>
<p><b>EGPRS mode 2 IE</b> This information element is defined in sub-clause 12.48a.1.</p>
<p><b>EMST_NW_Capability</b> (1 bit field) See sub-clause 11.2.29 (Packet Uplink Assignment message).</p>
<p><b>TFI</b> (5 bit field) See sub-clause 11.2.31 (Packet Timeslot Reconfigure message).</p>
<p><b>RLC_MODE</b> (1 bit field) See sub-clause 11.2.31 (Packet Timeslot Reconfigure message). If the <b>RLC_RESET</b> field indicates that any given RLC entity is not reset across PS handover then the mobile station shall ignore this field and use the same RLC mode that was used for the corresponding PFC in the old cell.</p>
<p><b>EGPRS Window Size</b> This information element is defined in sub-clause 12.5.2.</p>
<p><b>PFI</b> (7 bit field) See sub-clause 11.2.31 (Packet Timeslot Reconfigure message).</p>
<p><b>NPM Transfer Time</b> (5 bit field) This field contains the NPM Transfer Time limitation for TBF or RLC entity assigned to operate in RLC non-persistent mode. If EMSR is supported this field contains the NPM Transfer Time limitation for a specific Packet Flow Context configured to use RLC non-persistent mode.</p>
<p><b>MTTI_DOWNLINK_ASSIGNMENT_C1</b> (1 bit field) <b>MTTI_DOWNLINK_ASSIGNMENT_C2</b> (1 bit field) See sub-clause 11.2.7 (Packet Downlink Assignment message).</p>
<p><b>MTTI_UPLINK_ASSIGNMENT_C1</b> (1 bit field) <b>MTTI_UPLINK_ASSIGNMENT_C2</b> (1 bit field) See sub-clause 11.2.29 (Packet Uplink Assignment message).</p>
<p><b>EGPRS Packet Downlink Ack/Nack Type 3 Support</b> (1 bit field) See sub-clause 11.2.7 (Packet Downlink Assignment message).</p>
<p><b>Primary TSC Set</b> (1 bit field) <b>Secondary DL TSC Set</b> (1 bit field) See sub-clause 12.46.</p>
<p><b>Primary TSC Value</b> (3 bit field) See sub-clause 12.46.</p>
<p><b>Secondary DL TSC Value</b> (3 bit field) See sub-clause 12.46.</p>



## 12.48a PS resources assignment information elements

### 12.48a.1 EGPRS mode 2

This information element provides the description of uplink and / or downlink radio resources assigned for PS services in a dual carrier configuration or supporting EGPRS2, Fast Ack/Nack Reporting or RTTI configurations for single TBF or a multiple TBF capable mobile station.

**Table 12.48a.1.1: EGPRS mode 2 information element**

<pre> &lt; EGPRS mode 2 IE &gt; ::=   { 0   1 &lt; BEP_PERIOD2 : bit(4) &gt; }   { 0 -- SINGLE TBF ASSIGNMENT     { 0   1 -- Single Downlink TBF       &lt; Downlink Assignment : &lt; Single Downlink Assignment 2 IE &gt; &gt;     }     { 0   1 -- Single Uplink TBF       &lt; Uplink Assignment : &lt; Single Uplink Assignment 2 IE &gt; &gt;     }   }     1 -- MULTIPLE TBF ASSIGNMENT     -- THIS ASSIGNMENT CHOICE SHALL ONLY BE SELECTED BY THE NETWORK     -- FOR ASSIGNING RESOURCES TO A MOBILE STATION SUPPORTING     -- MULTIPLE TBF PROCEDURES IN A/GB MODE (see 3GPP TS 24.008)     { 0   1 -- Multiple downlink TBF(s)       &lt; Multiple Downlink Assignment : &lt; Multiple Downlink Assignment 2 IE &gt; &gt;     }     { 0   1 -- Multiple uplink TBF(s)       &lt; Multiple Uplink Assignment : &lt; Multiple Uplink Assignment 2 IE &gt; &gt;     }   } }; </pre>
---

**Table 12.48a.1.2: EGPRS mode 2 information element details**

<p><b>BEP_PERIOD2</b> (4 bit field) See sub-clause 11.2.29 (Packet Uplink Assignment message).</p>
<p><b>Single Downlink Assignment 2 IE</b> This information element is defined in sub-clause 12.48a.2.</p>
<p><b>Single Uplink Assignment 2 IE</b> This information element is defined in sub-clause 12.48a.3.</p>
<p><b>Multiple Downlink Assignment 2 IE</b> This information element is defined in sub-clause 12.48a.5.</p>
<p><b>Multiple Uplink Assignment 2 IE</b> This information element is defined in sub-clause 12.48a.6.</p>

### 12.48a.2 Single Downlink Assignment 2

This information element provides the description of downlink radio resources assigned for PS services in a dual carrier configuration or supporting EGPRS2, Fast Ack/Nack Reporting or RTTI configurations for a single TBF.

Table 12.48a.2.1: Single Downlink Assignment 2 information element

```

< Single Downlink Assignment 2 IE > ::=
{ 0 | 1 < Downlink EGPRS Window Size : < EGPRS Window Size IE > > }
< LINK_QUALITY_MEASUREMENT_MODE : bit (2) >
< Downlink EGPRS Level: < EGPRS Level IE > >
{ 0 -- Fast Ack/Nack Reporting is not activated for the downlink TBF;
| 1 -- Fast Ack/Nack Reporting is activated for the downlink TBF
  < EVENT_BASED_FANR: bit (1) > }
{ 0 -- BTTI mode
  < TIMESLOT_ALLOCATION_C1 : bit (8) >
  { 0 | 1 < TIMESLOT_ALLOCATION_C2 : bit (8) > }
| 1 -- RTTI mode
  { 0 -- Single Carrier Assignment
    { 00 -- Default PDCH-pair configuration
    | 01 -- Unchanged
    | 10 -- Explicit PDCH pair configuration
      < DOWNLINK_PDCH_PAIRS_C1 : bit (8) >
      < UPLINK_PDCH_PAIRS_C1 : bit (8) >
      ! < PDCH pairs configuration error : { 1 1 } bit (*) = < no string > -- reserved
    }
    < RTTI_DOWNLINK_PDCH_PAIR_ASSIGNMENT_SC : bit (4) >
  | 1 -- Dual Carrier Assignment
    { 00 -- Default PDCH pair configuration
    | 01 -- Unchanged
    | 10 -- Explicit PDCH pair configuration
      < DOWNLINK_PDCH_PAIRS_C1 : bit (8) >
      < DOWNLINK_PDCH_PAIRS_C2 : bit (8) >
      < UPLINK_PDCH_PAIRS_C1 : bit (8) >
      < UPLINK_PDCH_PAIRS_C2 : bit (8) >
      ! < PDCH pairs configuration error : { 1 1 } bit (*) = < no string > -- reserved
    }
    < RTTI_DOWNLINK_PDCH_PAIR_ASSIGNMENT_DC : bit (8) >
  }
}
{ 0 | 1 < PFI : bit (7) > }
< RLC_MODE : bit (1) >
< DOWNLINK_TFI_ASSIGNMENT : bit (5) >
< CONTROL_ACK : bit (1) >
{ 0 | 1 < NPM Transfer Time : bit (5) > }
;

```

Table 12.48a.2.2: Single Downlink Assignment 2 information element details

<b>EGPRS Window Size IE (Downlink EGPRS Window Size)</b> This information element is defined in sub-clause 12.5.2.
<b>LINK_QUALITY_MEASUREMENT_MODE (2 bit field)</b> See sub-clause 11.2.7 (Packet Downlink Assignment message).
<b>EGPRS Level IE (Downlink EGPRS Level)</b> This information element is defined in sub-clause 12.10f.
<b>EVENT_BASED_FANR (1 bit field)</b> See sub-clause 11.2.7 (Packet Downlink Assignment message).
<b>TIMESLOT_ALLOCATION_C1, TIMESLOT_ALLOCATION_C2 (8 bit field)</b> See sub-clause 11.2.7 (Packet Downlink Assignment message).

<b>DOWNLINK_PDCH_PAIRS_C1</b> <b>DOWNLINK_PDCH_PAIRS_C2</b> <b>UPLINK_PDCH_PAIRS_C1</b> <b>UPLINK_PDCH_PAIRS_C2</b> <b>RTTI_DOWNLINK_PDCH_PAIR_ASSIGNMENT_SC</b> <b>RTTI_DOWNLINK_PDCH_PAIR_ASSIGNMENT_DC</b> See sub-clause 11.2.31 (Packet Timeslot Reconfigure message).
<b>PFI</b> (7 bit field) See sub-clause 11.2.7 (Packet Downlink Assignment message).
<b>RLC_MODE</b> (1 bit field) This field contains the RLC mode to be used for the assigned TBF. If a new mode is assigned by the network for an already established TBF, the MS shall ignore the new assigned mode and shall maintain the TBF in the old mode. If the RLC_RESET field indicates that any given RLC entity is not reset across PS handover (see sub-clause 12.42a) or DTM handover (see sub-clause 12.48) then the mobile station shall ignore this field and use the same RLC mode that was used for the corresponding PFC in the old cell.  The encoding of this field is defined as in sub-clause 11.2.29 (Packet Uplink Assignment message).
<b>DOWNLINK_TFI_ASSIGNMENT</b> (5 bit field) See sub-clause 11.2.7 (Packet Downlink Assignment message).
<b>CONTROL_ACK</b> (1 bit field) See sub-clause 11.2.7 (Packet Downlink Assignment message).
<b>NPM Transfer Time</b> (5 bit field) See sub-clause 11.2.7 (Packet Downlink Assignment message).

### 12.48a.3 Single Uplink Assignment 2

This information element provides the description of uplink radio resources assigned for PS services in a dual carrier configuration or supporting EGPRS2, Fast Ack/Nack Reporting or RTTI configurations for a single TBF.

**Table 12.48a.3.1: Single Uplink Assignment 2 information element**

<pre> &lt; Single Uplink Assignment 2 IE &gt; ::=   &lt; EGPRS Channel Coding Command : &lt; EGPRS Modulation and Coding Scheme IE &gt; &gt; }   &lt; RESEGMENT : bit (1) &gt;   { 0   1 &lt; Uplink EGPRS Window Size : &lt; EGPRS Window Size IE &gt; &gt; }   &lt; Uplink EGPRS Level: &lt; EGPRS Level IE &gt; &gt;   { 0   1 -- '1' indicates that FANR is activated     { 0 -- SSN-based encoding is selected         1 -- Time-based encoding is selected         &lt; REPORTED_TIMESLOTS_C1 : bit (8) &gt; -- Carrier 1 in Downlink Dual Carrier configuration         { 0   1 &lt; REPORTED_TIMESLOTS_C2 : bit (8) &gt; } -- Carrier 2 in Downlink Dual Carrier configuration         &lt; TSH : bit (2) &gt; } }   { 0 -- BTTI mode       1 -- RTTI mode       &lt; RTTI_USF_MODE : bit (1) &gt;       -- The Uplink Assignment PDCH Pairs Description IE shall not be included       -- when an RTTI configuration description for downlink TBF(s) is provided in the message       { 0   1 &lt; Uplink Assignment PDCH Pairs Description : &lt; PDCH Pairs Description IE &gt; &gt; }     }   &lt; Dynamic Allocation 2 : &lt; Dynamic Allocation 2 IE &gt; &gt;   { 0   1 &lt; PFI : bit (7) &gt; }   &lt; RLC_MODE : bit (1) &gt;   { 0   1 &lt; NPM Transfer Time : bit (5) &gt; }   { 0   1 &lt; Pulse Format: &lt; Pulse Format IE &gt; &gt; }   ; </pre>
--

**Table 12.48a.3.2: Single Uplink Assignment 2 information element details**

<p><b>EGPRS Modulation and Coding Scheme IE (EGPRS Channel Coding Command)</b> This information element is defined in sub-clause 12.10d.</p> <p>See sub-clause 11.2.29 (Packet Uplink Assignment message).</p>
<p><b>RESEGMENT</b> (1 bit field) This field is defined in sub-clause 12.10e.</p>
<p><b>EGPRS Window Size IE (Uplink EGPRS Window Size)</b> This information element is defined in sub-clause 12.5.2.</p>
<p><b>EGPRS Level IE (Uplink EGPRS Level)</b> This information element is defined in sub-clause 12.10f.</p>
<p><b>REPORTED TIMESLOTS C1, REPORTED TIMESLOTS C2</b> (8 bit field) See sub-clause 11.2.29 (Packet Uplink Assignment message).</p>
<p><b>TSH</b> (2 bit field) See sub-clause 11.2.29 (Packet Uplink Assignment message).</p>
<p><b>RTTI_USF_MODE</b> (1 bit field) See sub-clause 11.2.29 (Packet Uplink Assignment message).</p>
<p><b>PDCH Pairs Description IE (Uplink Assignment PDCH Pairs Description)</b> This information element is defined in sub-clause 12.5.5.</p> <p>Specific conditions apply for the inclusion of this information element (see sub-clause 7.1.3.6).</p>
<p><b>Dynamic Allocation 2 IE</b> This information element is defined in sub-clause 12.48a.4.</p>
<p><b>PFI</b> (7 bit field) See sub-clause 11.2.29 (Packet Uplink Assignment message).</p>
<p><b>RLC_MODE</b> (1 bit field) See sub-clause 12.48a.2 (<i>Single Downlink Assignment 2</i> information element).</p>
<p><b>NPM Transfer Time</b> (5 bit field) See sub-clause 11.2.29 (Packet Uplink Assignment message).</p>
<p><b>Pulse Format IE</b> This information element is defined in sub-clause 12.8.3.</p>

## 12.48a.4 Dynamic Allocation 2

This information element provides the description of the uplink dynamic allocation information for a BTTI or an RTTI assignment in a single or a dual carrier configuration with or without power control parameters.

Table 12.48a.4.1: Dynamic Allocation 2 information element

```

< Dynamic Allocation 2 IE > ::=
  < EXTENDED_DYNAMIC_ALLOCATION : bit (1) >
  { 0 | 1 < P0_C1 : bit (4) >
    < PR_MODE_C1 : bit (1) >
    { 0 | 1 < P0_C2 : bit (4) >
      < PR_MODE_C2 : bit (1) > } }
  < USF_GRANULARITY : bit (1) >
  { 0 | 1 < UPLINK_TFI_ASSIGNMENT : bit (5) > }
  { 0 -- Allocation without Power Control Parameters
    < N_USF : bit (4) >
    { 0 | 1 < USF : bit (3) > } * ( val(N_USF) + 1 )
  | 1 -- Allocation with Power Control Parameters
    < ALPHA_C1 : bit (4) >
    { 0 | 1 < ALPHA_C2 : bit (4) > }
    { 0 -- BTTI mode
      < N_TS : bit (4) >
      { 0 | 1
        < USF : bit (3) >
        < GAMMA : bit (5) >
      } * ( val(N_TS) + 1 )
    | 1 -- RTTI mode
      < N_PAIRS : bit (3) >
      { 0 | 1
        < USF : bit (3) >
        < GAMMA : bit (5) >
      } * ( val(N_PAIRS) + 1 )
      { 0 -- RTTI USF
        | 1 -- BTTI USF
          { 0 | 1 < USF_2 : bit (3) >
            { 0 | 1 < GAMMA : bit (5) > }
          } * ( val(N_PAIRS) + 1 )
      }
    }
  }
};

```

Table 12.48a.4.2: Dynamic Allocation 2 element details

**EXTENDED\_DYNAMIC\_ALLOCATION** (1 bit field)

This information field indicates the medium access mode to be used during the TBF.

0 Dynamic Allocation

1 Extended Dynamic Allocation

**P0\_C1, P0\_C2** (4 bit field)

These fields are optional downlink power control parameters.

If the Assignment Type field is present and indicates 'Dual Carrier assignment', P0\_C1 and P0\_C2 apply to carrier 1 and carrier 2, respectively. The presence of these parameters indicates that downlink power control is used for the indicated carrier; otherwise, downlink power control is not used for the indicated carrier. If the P0\_C1 IE is present but the P0\_C2 IE is absent, then the P0\_C1 IE shall apply also to carrier 2.

If the Assignment Type field is included and indicates 'Assignment on single carrier only' or 'Modification of existing assignment', then P0\_C1 shall apply to the carrier specified in the Carrier ID field.

These fields are encoded as follows:

bit

4 3 2 1

0 0 0 0 P0 = 0 dB

0 0 0 1 P0 = 2 dB

0 0 1 0 P0 = 4 dB

:

1 1 1 1 P0 = 30 dB

**PR\_MODE\_C1, PR\_MODE\_C2** (1 bit field)

These fields indicate the PR Management mode, as defined in 3GPP TS 45.008.

If the Assignment Type field is included and indicates 'Assignment on single carrier only' or 'Modification of existing assignment', then PR\_MODE\_C1 shall apply to the carrier specified in the Carrier ID field. Otherwise, PR\_MODE\_C1 and PR\_MODE\_C2 shall apply to carrier 1 and carrier 2 respectively. If the Assignment Type field indicates 'Dual Carrier assignment' and the PR\_MODE\_C1 IE is present but the PR\_MODE\_C2 IE is absent, then the PR\_MODE\_C1 IE shall apply also to carrier 2. It is encoded as follows:

- 0 PR mode A: for one addressed MS
- 1 PR mode B: for all MS

**USF\_GRANULARITY** (1 bit field)

This information field indicates the USF granularity to be applied by the mobile station when it is assigned a TBF using Dynamic Allocation or Extended Dynamic Allocation.

- 0 the mobile station shall transmit one RLC/MAC block
- 1 the mobile station shall transmit four consecutive RLC/MAC blocks

**UPLINK\_TFI\_ASSIGNMENT** (5 bit field)

This information element, if present, assigns the contained TFI to the mobile station to identify an uplink TBF described by this message. This field is coded the same as the TFI field defined in sub-clause 12.15.

**N\_USF, N\_TS** (4 bit field)**N\_PAIRS** (3 bit field)

These fields indicate respectively the number of USF, timeslots or PDCH pairs assigned to a given uplink TBF. The number of timeslots or PDCH pairs is given as the binary value of the corresponding field plus one.

See Annex K for details of the coding of these fields.

**ALPHA\_C1, ALPHA\_C2** (4 bit field)

If the Assignment Type field is included and indicates 'Assignment on single carrier only' or 'Modification of existing assignment', then ALPHA\_C1 (if present) shall apply to the carrier specified in the Carrier ID field.

If the Assignment Type field is included and indicates 'Dual Carrier assignment', ALPHA\_C1 and ALPHA\_C2 indicate the value of the parameter alpha to be applied in power control on carrier 1 and carrier 2 respectively. For encoding and description see the Global Power Control Parameters IE. If ALPHA\_C1 is present and ALPHA\_C2 is absent, then ALPHA\_C1 shall apply to carrier 2.

**USF, USF\_2** (3 bit field)

These fields indicate the USF values assigned to a given TBF for the assigned timeslot or PDCH pair.

In the case of RTTI mode with BTTI USF, the USF value specified in the USF field (respectively USF\_2 field) applies to the first two (respectively second two) TDMA frames of the following basic radio block period (see sub-clauses 8.1.1.1, 8.1.1.2.1).

These fields are encoded as a binary representation of the USF value as defined in sub-clause 10.4.1.

The order in which USF assignments are encoded and the meaning when the number of repetitions of the USF is lower than the maximum is described in Annex K.

**GAMMA** (5 bit field)

This field is the binary representation of the parameter  $\Gamma_{CH}$  for MS output power control in units of 2 dB, see 3GPP TS 45.008. The field is coded according to the following table:

bit	
5 4 3 2 1	
0 0 0 0 0	$\Gamma_{CH} = 0$ dB
0 0 0 0 1	$\Gamma_{CH} = 2$ dB
...	
1 1 1 1 0	$\Gamma_{CH} = 60$ dB
1 1 1 1 1	$\Gamma_{CH} = 62$ dB

In the case of RTTI mode with BTTI USF, exactly one GAMMA field shall be included for each PDCH pair for which either one or two USF values are assigned.

## 12.48a.5 Multiple Downlink Assignment 2

This information element provides the description of downlink radio resources assigned for PS services in a dual carrier configuration or supporting EGPRS2, Fast Ack/Nack Reporting or RTTI configurations for a multiple TBF capable mobile station.

This information element shall only be used by the network for assigning resources to a mobile station supporting multiple TBF procedures in A/Gb mode (see sub-clauses 11.2.37, 12.42a and 12.48 and 3GPP TS 24.008).

Table 12.48a.5.1: Multiple Downlink Assignment 2 information element

```

< Multiple Downlink Assignment 2 IE > ::=
{ 0 | 1 < Downlink EGPRS Window Size : < EGPRS Window Size IE > > }
< LINK_QUALITY_MEASUREMENT_MODE : bit (2) >
< Downlink EGPRS Level: < EGPRS Level IE > >
{ 0 | 1      -- BTTI mode
  < FANR: bit (1) >
  { 1 < BTTI Multiple Downlink Assignment : < BTTI Multiple Downlink Assignment struct > > } ** 0
}
{ 0 | 1      -- RTTI mode
  { 0          -- Single Carrier Assignment
    { 00      -- Default PDCH-pair configuration
    | 01      -- Unchanged
    | 10      -- Explicit PDCH pair configuration
      < DOWNLINK_PDCH_PAIRS_C1 : bit (8) >
      < UPLINK_PDCH_PAIRS_C1 : bit (8) >
      ! < PDCH pairs configuration error : { 1 1 } bit (*) = < no string > >      -- reserved
    }
    { 1 < RTTI Multiple Downlink Assignment SC : RTTI Multiple Downlink Assignment SC struct > > } ** 0
  | 1          -- Dual Carrier Assignment
    { 00      -- Default PDCH pair configuration
    | 01      -- Unchanged
    | 10      -- Explicit PDCH pair configuration
      < DOWNLINK_PDCH_PAIRS_C1 : bit (8) >
      < DOWNLINK_PDCH_PAIRS_C2 : bit (8) >
      < UPLINK_PDCH_PAIRS_C1 : bit (8) >
      < UPLINK_PDCH_PAIRS_C2 : bit (8) >
      ! < PDCH pairs configuration error : { 1 1 } bit (*) = < no string > >      -- reserved
    }
    { 1 < RTTI Multiple Downlink Assignment DC : < RTTI Multiple Downlink Assignment DC struct > > } ** 0
  }
}
};

< BTTI Multiple Downlink Assignment struct > ::=
< TIMESLOT_ALLOCATION_C1 : bit (8) >
{ 0 | 1 < TIMESLOT_ALLOCATION_C2 : bit (8) > }
{ 0 | 1 < Uplink Control Timeslot C1 : bit (3) > }
{ 0 | 1 < Uplink Control Timeslot C2 : bit (3) > }
{ 1 < Downlink TBF assignment : < Downlink TBF assignment 2 struct > > } ** 0 ;

< RTTI Multiple Downlink Assignment SC struct > ::=
< RTTI_DOWNLINK_PDCH_PAIR_ASSIGNMENT_SC : bit (4) >
{ 0 | 1 < Uplink Control Timeslot C1 : bit (3) > }
{ 1 < Downlink TBF assignment : < Downlink TBF assignment 2 struct > > } ** 0 ;

< RTTI Multiple Downlink Assignment DC struct > ::=
< RTTI_DOWNLINK_PDCH_PAIR_ASSIGNMENT_DC : bit (8) >
{ 0 | 1 < Uplink Control Timeslot C1 : bit (3) > }
{ 0 | 1 < Uplink Control Timeslot C2 : bit (3) > }
{ 1 < Downlink TBF assignment : < Downlink TBF assignment 2 struct > > } ** 0 ;

< Downlink TBF assignment 2 struct > ::=
{ 0 | 1 < PFI : bit (7) > }
< RLC_MODE : bit (1) >
{ 0 | 1 < Uplink Control Timeslot C1 : bit (3) > }
{ 0 | 1 < Uplink Control Timeslot C2 : bit (3) > }
< TFI Assignment : bit (5) >
< CONTROL_ACK : bit (1) >
{ 0 | 1 < NPM Transfer Time : bit (5) > }
< EVENT_BASED_FANR : bit (1) >
{ 0 | 1 < Downlink EGPRS Window Size : < EGPRS Window Size IE > > } ;

```



**Table 12.48a.5.2: Multiple Downlink Assignment 2 information element details**

<p><b>EGPRS Window Size IE (Downlink EGPRS Window Size)</b> This information element is defined in sub-clause 12.5.2.</p> <p>Specific conditions apply for the interpretation of this information element. See sub-clause 11.2.37 (Packet CS Release Indication message).</p>
<p><b>LINK_QUALITY_MEASUREMENT_MODE</b> (2 bit field) See sub-clause 11.2.7 (Packet Downlink Assignment message).</p>
<p><b>EGPRS Level IE (Downlink EGPRS Level)</b> This information element is defined in sub-clause 12.10f.</p>
<p><b>FANR</b> (1 bit field) See sub-clause 11.2.7a (Multiple TBF Downlink Assignment message).</p>
<p><b>DOWNLINK_PDCH_PAIRS_C1</b> <b>DOWNLINK_PDCH_PAIRS_C2</b> <b>UPLINK_PDCH_PAIRS_C1</b> <b>UPLINK_PDCH_PAIRS_C2</b> <b>RTTI_DOWNLINK_PDCH_PAIR_ASSIGNMENT_SC</b> <b>RTTI_DOWNLINK_PDCH_PAIR_ASSIGNMENT_DC</b> See sub-clause 11.2.31 (Packet Timeslot Reconfigure message).</p>
<p><b>TIMESLOT_ALLOCATION_C1, TIMESLOT_ALLOCATION_C2</b> (8 bit field) See sub-clause 11.2.7 (Packet Downlink Assignment message).</p>
<p><b>Uplink Control Timeslot C1, Uplink Control Timeslot C2</b> (3 bit field) In case of a BTTI configuration, these fields contain the timeslot number on carrier1 (respectively carrier 2) of the timeslot where the PACCH/U for the MS is located. In case of an RTTI configuration, these fields contain the timeslot number of the timeslot on carrier1 (respectively carrier 2) belonging to the uplink PDCH pair where the PACCH/U for the MS is located. They are encoded as the binary representation of the timeslot number as defined in 3GPP TS 45.002.</p> <p>If these fields are included in the <i>BTTI Multiple Downlink Assignment IE</i> or in the <i>RTTI Multiple Downlink Assignment SC / DC IE</i>, they shall refer to all downlink TBFs assigned in the message. If these fields are included in the <i>Downlink TBF Assignment 2 IE</i>, they refer only to the TBF given by the TFI Assignment field (the specific values overrule any default values given in the <i>BTTI Multiple Downlink Assignment IE</i> or in the <i>RTTI Multiple Downlink Assignment SC / DC IE</i>). If the <i>Uplink Control Timeslot C1 / Uplink Control Timeslot C2</i> field is not included in the message at all, then the default rules for the location of PACCH/U apply.</p>
<p><b>PFI</b> (7 bit field) This field shall only be included for TBFs if both the network and the mobile station support multiple TBFs. This field contains the PFI parameter identifying a Packet Flow Context. The PFI parameter is encoded as the contents of the PFI information element as defined in 3GPP TS 44.018.</p>
<p><b>RLC_MODE</b> (1 bit field) See sub-clause 12.48a.2 (<i>Single Downlink Assignment 2</i> information element).</p>
<p><b>TFI Assignment</b> (5 bit field) See sub-clause 11.2.7a (Multiple TBF Downlink Assignment message).</p>
<p><b>CONTROL_ACK</b> (1 bit field) See sub-clause 12.42 (<i>PS Handover Radio Resources</i> information element).</p>
<p><b>NPM Transfer Time</b> (5 bit field) This field contains the NPM Transfer Time limitation in case of RLC non-persistent mode and is defined in sub-clause 12.45a.</p>
<p><b>EVENT_BASED_FANR</b> (1 bit field) See sub-clause 11.2.7a (Multiple TBF Downlink Assignment message).</p>

## 12.48a.6 Multiple Uplink Assignment 2

This information element provides the description of uplink radio resources assigned for PS services in a dual carrier configuration or supporting EGPRS2, Fast Ack/Nack Reporting or RTTI configurations for a multiple TBF capable mobile station.

This information element shall only be used by the network for assigning resources to a mobile station supporting multiple TBF procedures in A/Gb mode (see sub-clauses 11.2.37, 12.42a and 12.48 and 3GPP TS 24.008).

Table 12.48a.6.1: Multiple Uplink Assignment 2 information element

```

< Multiple Uplink Assignment 2 IE > ::=
{ 0 | 1 < EGPRS Channel Coding Command : < EGPRS Modulation and Coding Scheme IE > > }
< RESEGMENT : bit (1) >
{ 0 | 1 < Uplink EGPRS Window Size : < EGPRS Window Size IE > > }
< EXTENDED_DYNAMIC_ALLOCATION : bit (1) >
{ 0 | 1 < P0_C1 : bit (4) >
  < PR_MODE_C1 : bit(1) >
  { 0 | 1 < P0_C2 : bit (4) >
    < PR_MODE_C2 : bit(1) > } }
{ 0 | 1 -- '1' indicates that FANR is activated
  { 0 -- SSN-based encoding is selected
    | 1 -- Time-based encoding is selected
  < TSH : bit (2) > } }
{ 0 | 1 -- BTTI mode
  < Global Timeslot description : < Timeslot description 2 struct > >
  { 1 < BTTI Uplink TBF Assignment : < BTTI Uplink TBF Assignment struct > > } ** 0
}

{ 0 | 1 -- RTTI mode

-- The Uplink Assignment PDCH Pairs Description IE shall not ne included
-- when an RTTI configuration description for downlink TBF(s) is provided in the message
{ 0 | 1 < Uplink Assignment PDCH Pairs Description : < PDCH Pairs Description IE > > }

< N_PAIRS : bit (3) > -- Number minus 1 of the uplink pairs of the PDCH pairs description
-- assigned to the TBF
{ 0 -- Without power control parameters
  | 1 -- With power control parameters
  < ALPHA_C1 : bit (4) >
  { 0 | 1 < ALPHA_C2 : bit (4) > }
  { 0 | 1 < GAMMA : bit (5) > } * (val (N_PAIRS) + 1)
  { 0 -- RTTI USF, or no second GAMMA values are given in case of RTTI mode with BTTI USF
    | 1 -- Second GAMMA values are given in case of RTTI mode with BTTI USF
    { 0 | 1 < GAMMA : bit (5) > } * (val (N_PAIRS) + 1)
  }
}
}
{ 1 < RTTI_USF_MODE : bit (1) >
  < RTTI Uplink TBF Assignment : < RTTI Uplink TBF Assignment struct > >
} ** 0
}

< Uplink EGPRS Level: < EGPRS Level IE > >
{ 0 | 1 < Pulse Format: < Pulse Format IE > > }
;

```

```

< BTTI Uplink TBF Assignment struct > ::=                -- Recursive for multiple BTTI TBFs
{ 0 | 1 < PFI : bit (7) > }
< RLC_MODE : bit (1) >
< TFI Assignment : bit (5) >
{ 0 | 1 < EGPRS Channel Coding Command : < EGPRS Modulation and Coding Scheme IE > > }
{ 0 | 1 < Uplink EGPRS Window Size : < EGPRS Window Size IE > > }
{ 0 | 1 < NPM Transfer Time : bit (5) > }
{ 0 | 1 -- '1': Time-based encoding FANR is activated
  < REPORTED TIMESLOTS_C1 : bit (8) >                -- Carrier 1 in Downlink Dual Carrier configuration
  { 0 | 1 < REPORTED TIMESLOTS C2 : bit (8) > } -- Carrier 2 in Downlink Dual Carrier configuration
}
< USF_GRANULARITY : bit (1) >

< N_TS : bit (4) >                -- Number minus 1 of the timeslots of the Global Timeslot description
                                   -- assigned to the TBF
{ 0                                -- 0: All timeslots in Global Timeslot description are assigned to the TBF
| 1                                -- 1: Only timeslots in TBF_TIMESLOT_ALLOCATION are assigned to the TBF
  < TBF_TIMESLOT_ALLOCATION : bit (val (N_TS) + 1) > }
{ 0 < USF_C1 : bit (3) >          -- Same USF valid on all timeslots assigned to the TBF on the respective carriers
  { 0 | 1 < USF_C2 : bit (3) > }
| 1                                -- Different USF(s) assigned:
  < USF : bit (3) >                -- USF for the first assigned timeslot
  { 0 | 1 < USF : bit (3) > } * (val (N_TS) + 1) -- USF for next assigned timeslots (omitted=same as previous)
};

< RTTI Uplink TBF Assignment struct > ::=                -- Recursive for multiple RTTI TBFs
{ 0 | 1 < PFI : bit (7) > }
< RLC_MODE : bit (1) >
< TFI Assignment : bit (5) >
{ 0 | 1 < EGPRS Channel Coding Command : < EGPRS Modulation and Coding Scheme IE > > }
{ 0 | 1 < Uplink EGPRS Window Size : < EGPRS Window Size IE > > }
{ 0 | 1 < NPM Transfer Time : bit (5) > }
{ 0 | 1 -- '1': Time-based encoding FANR is activated
  < REPORTED TIMESLOTS_C1 : bit (8) >                -- Carrier 1 in Downlink Dual Carrier configuration
  { 0 | 1 < REPORTED TIMESLOTS C2 : bit (8) > } -- Carrier 2 in Downlink Dual Carrier configuration
}
< USF_GRANULARITY : bit (1) >

{ 0                                -- The PDCH pairs assigned to the TBF are all the PDCH pairs described
                                   -- in the PDCH pairs description
| 1 < TBF_UPLINK_PAIRS_ALLOCATION : bit (val (N_PAIRS) + 1) > }
{ 0 < USF_C1 : bit (3) >          -- Same USF valid on all pairs assigned to the TBF on the respective carriers
  { 0 | 1 < USF_C2 : bit (3) > }
| 1                                -- Different USF(s) assigned
  < USF : bit (3) >                -- USF for the first assigned PDCH pair
  { 0 | 1 < USF : bit (3) > } * (val (N_PAIRS)) -- Next assigned PDCH pairs (omitted=same as previous)
  { 0 -- RTTI USF mode
| 1 -- BTTI USF mode (second USF)
  < USF_2 : bit (3) >                -- Second USF for the first assigned PDCH pair
  { 0 | 1 < USF_2 : bit (3) > } * (val (N_PAIRS)) -- Next assigned PDCH pairs (omitted=same as previous)
}
};

```

```

< Timeslot description 2 struct > ::=
{ 0
  < MS_TIMESLOT_ALLOCATION_C1 : bit (8) >
  { 0 | 1 < MS_TIMESLOT_ALLOCATION_C2 : bit (8) > }
| 1
  < ALPHA_C1 : bit (4) >
  { 0 | 1 < GAMMA_TN0_C1 : bit (5) > }
  { 0 | 1 < GAMMA_TN1_C1 : bit (5) > }
  { 0 | 1 < GAMMA_TN2_C1 : bit (5) > }
  { 0 | 1 < GAMMA_TN3_C1 : bit (5) > }
  { 0 | 1 < GAMMA_TN4_C1 : bit (5) > }
  { 0 | 1 < GAMMA_TN5_C1 : bit (5) > }
  { 0 | 1 < GAMMA_TN6_C1 : bit (5) > }
  { 0 | 1 < GAMMA_TN7_C1 : bit (5) > }
  { 0 | 1 < ALPHA_C2 : bit (4) > }
  { 0 | 1 < GAMMA_TN0_C2 : bit (5) > }
  { 0 | 1 < GAMMA_TN1_C2 : bit (5) > }
  { 0 | 1 < GAMMA_TN2_C2 : bit (5) > }
  { 0 | 1 < GAMMA_TN3_C2 : bit (5) > }
  { 0 | 1 < GAMMA_TN4_C2 : bit (5) > }
  { 0 | 1 < GAMMA_TN5_C2 : bit (5) > }
  { 0 | 1 < GAMMA_TN6_C2 : bit (5) > }
  { 0 | 1 < GAMMA_TN7_C2 : bit (5) > } } ;

```

**Table 12.48a.6.2: Multiple Uplink Assignment 2 information element details**

<p><b>EGPRS Modulation and Coding Scheme IE (EGPRS Channel Coding Command)</b>  This information element is defined in sub-clause 12.10d .</p> <p>Specific conditions apply for the inclusion of this information element. See sub-clause 11.2.29a (Multiple TBF Uplink Assignment message).</p>
<p><b>RESEGMENT</b> (1 bit field)  This field is defined in sub-clause 12.10e.</p>
<p><b>EXTENDED_DYNAMIC_ALLOCATION</b> (1 bit field)  See sub-clause 11.2.29 (Packet Uplink Assignment message).</p>
<p><b>P0_C1, P0_C2</b> (4 bit field)  See sub-clause 11.2.29 (Packet Uplink Assignment message).</p>
<p><b>PR_MODE_C1, PR_MODE_C2</b> (1 bit field)  See sub-clause 11.2.29 (Packet Uplink Assignment message).</p>
<p><b>TSH</b> (2 bit field)  See sub-clause 11.2.29 (Packet Uplink Assignment message).</p>
<p><b>Uplink Assignment PDCH Pairs Description</b>  This information element is defined in sub-clause 12.5.5.</p> <p>Specific conditions apply for the inclusion of this information element (see sub-clause 7.1.3.6).</p>
<p><b>N_TS, N_PAIRS,</b>  These fields indicate respectively the number of timeslots or PDCH pairs assigned to a given uplink TBF. The number of timeslots or PDCH pairs is given as the binary value of the corresponding field plus one.</p> <p>See Annex K for details of the coding of these fields.</p>
<p><b>ALPHA_C1, ALPHA_C2</b> (4 bit field)  See sub-clause 11.2.29 (Packet Uplink Assignment message).</p>

<p><b>GAMMA, GAMMA_TN<sub>x</sub>_C1, GAMMA_TN<sub>x</sub>_C2</b> (5 bit field)  These fields are the binary representation of the parameter <math>\Gamma_{CH}</math> for MS output power control in units of 2 dB, see 3GPP TS 45.008.</p> <p>See sub-clause 11.2.29 (Packet Uplink Assignment message).</p>
<p><b>RTTI_USF_MODE</b> (1 bit field)  See sub-clause 11.2.29 (Packet Uplink Assignment message).</p>
<p><b>EGPRS Level IE (Uplink EGPRS Level)</b>  This information element is defined in sub-clause 12.10f.</p>
<p><b>Pulse Format IE</b>  This information element is defined in sub-clause 12.8.3.</p>
<p><b>PFI</b> (7 bit field)  This field shall only be included for TBFs if both the network and the mobile station support multiple TBFs. This field contains the PFI parameter identifying a Packet Flow Context. The PFI parameter is encoded as the contents of the PFI information element as defined in 3GPP TS 44.018.</p>
<p><b>RLC_MODE</b> (1 bit field)  See sub-clause 12.48a.2 (<i>Single Downlink Assignment 2</i> information element).</p>
<p><b>TFI Assignment</b> (5 bit field)  See sub-clause 11.2.29a (Multiple TBF Uplink Assignment message).</p>
<p><b>EGPRS Window Size IE (Uplink EGPRS Window Size)</b>  This information element is defined in sub-clause 12.5.2.</p> <p>Specific conditions apply for the interpretation of this information element. See sub-clause 11.2.37 (Packet CS Release Indication message).</p>
<p><b>NPM Transfer Time</b> (5 bit field)  This field contains the NPM Transfer Time limitation in case of RLC non-persistent mode and is defined in sub-clause 12.45a.</p>
<p><b>REPORTED TIMESLOTS C1, REPORTED TIMESLOTS C2</b> (8 bit field)  See sub-clause 11.2.7a (Multiple TBF Downlink Assignment message).</p>
<p><b>USF_GRANULARITY</b> (1 bit field)  See sub-clause 11.2.29 (Packet Uplink Assignment message).</p>
<p><b>TBF_TIMESLOT_ALLOCATION</b> (N<sub>TS</sub>+1 bit field)  This field indicates the timeslots assigned to a particular uplink TBF, within the timeslots assigned to the mobile station in the <i>Global Timeslot description</i>. This field contains as many bits as there are timeslots assigned to the mobile station in the <i>Global Timeslot description</i>. Bit N<sub>TS</sub>+1 corresponds to the lowest numbered timeslot in the timeslots assigned to the mobile station; bit N<sub>TS</sub> (if any) corresponds to the next lowest numbered timeslot, etc. At least one timeslot must be assigned per TBF.</p> <p>0 Timeslot not assigned  1 Timeslot assigned</p> <p>If the TBF_TIMESLOT_ALLOCATION bitmap is present, then the timeslots assigned to the TBF are a subset of all the timeslots assigned in the <i>Global Timeslot description</i>, otherwise all timeslots in the <i>Global Timeslot description</i> are assigned to the TBF.</p>

**TBF\_UPLINK\_PAIRS\_ALLOCATION** (N\_PAIRS+1 bit field)

This field indicates the PDCH pairs assigned to a particular uplink TBF within the uplink PDCH pairs assigned to the mobile station, i.e. within the RTTI configuration description for downlink TBF(s) if provided, otherwise within the *Uplink Assignment PDCH Pairs Description* IE (see sub-clause 7.1.3.6). This field contains as many bits as there are uplink PDCH pairs assigned to the mobile station. Bit N\_TS+1 corresponds to the lowest numbered uplink PDCH pair assigned to the mobile station; bit N\_TS (if any) corresponds to the next lowest numbered PDCH pair, etc. (PDCH pairs numbering should be understood as defined in Annex K). At least one PDCH pair must be assigned per TBF.

- 0 PDCH pair not assigned
- 1 PDCH pair assigned

If the TBF\_UPLINK\_PAIRS\_ALLOCATION bitmap is present, then the PDCH pairs assigned to the TBF are a subset of all the uplink PDCH pairs assigned to the mobile station, otherwise all uplink PDCH pairs assigned to the mobile station are assigned to the TBF.

**USF\_C1, USF\_C2** (3 bit field)

These fields indicate the USF value assigned to a given TBF for all timeslots or PDCH pairs on the relevant carrier.

If the Assignment Type field is present and indicates 'Dual Carrier assignment', USF\_C1 applies to carrier 1, otherwise it applies to the carrier identified by the Carrier ID field.

If the Assignment Type field is present and indicates 'Dual Carrier assignment', and USF\_C1 is present and USF\_C2 is absent, the value specified by USF\_C1 applies to timeslots assigned on both carriers.

These fields are encoded as a binary representation of the USF value as defined in sub-clause 10.4.1.

**USF, USF\_2** (3 bit field)

These fields indicate the USF values assigned to a given TBF for the assigned timeslot or PDCH pair.

In the case of RTTI mode with BTTI USF, the USF value specified in the USF field (respectively USF\_2 field) applies to the first two (respectively second two) TDMA frames of the following basic radio block period (see sub-clauses 8.1.1.1, 8.1.1.2.1).

These fields are encoded as a binary representation of the USF value as defined in sub-clause 10.4.1.

If no USF is specified for a given timeslot or PDCH pair assigned to a TBF, then the USF value is the same as the previously indicated USF value.

The order in which USF assignments are encoded is described in Annex K.

**MS\_TIMESLOT\_ALLOCATION\_C1, MS\_TIMESLOT\_ALLOCATION\_C2**

See sub-clause 11.2.29a (Multiple TBF Uplink Assignment message).

As the explicit power control parameters are omitted for the allocated timeslots in the new cell, the mobile station shall use the default values (see 3GPP TS 45.008) for the power control parameters.

## 12.49 E-UTRAN Target Cell

The *E-UTRAN Target cell* information element contains the description of an E-UTRAN Target cell.

**Table 12.49.1: E-UTRAN Target cell information element**

```

< E-UTRAN Target cell IE > ::=
  < EARFCN : bit (16) >
  { 0 | 1 < Measurement Bandwidth: bit (3) > }
  < Physical Layer Cell Identity : bit (9) > ;

```

**Table 12.49.2: E-UTRAN Target cell information element details**

<p><b>EARFCN</b> (16 bit field) This information element is defined as the EARFCN in 3GPP TS 36.104.</p>
<p><b>Measurement Bandwidth</b> (3 bit field) This optional field describes the bandwidth of the E-UTRAN cell for measurement purposes. The coding of this field is as specified in sub-clause 12.53.</p>
<p><b>Physical Layer Cell Identity</b> (9 bit field) This field indicates the physical layer cell identity as defined in 3GPP TS 36.211.</p>

## 12.50 Individual Priorities

This information element is sent to provide MS-specific priorities for priority-based cell reselection (see 3GPP TS 45.008). The individual priorities shall override the priorities received through system information or previously received individual priorities. The timer T3230 is used to control the validity of the individual priorities.

**Table 12.50.1: Individual priorities information element**

```

< Individual priorities IE > ::=
  { 0 |      -- delete all stored individual priorities
    1      -- provide individual priorities
    < GERAN_PRIORITY : bit(3) >
    { 0 | 1 < 3G Individual Priority Parameters Description :
      < 3G Individual Priority Parameters Description struct >> }
    { 0 | 1 < E-UTRAN Individual Priority Parameters Description :
      < E-UTRAN Individual Priority Parameters Description struct >> }
    { 0 | 1 < T3230 timeout value : bit (3) > }
  };

< 3G Individual Priority Parameters Description struct > ::=
  { 0 | 1 < DEFAULT_UTRAN_PRIORITY : bit(3) > }
  { 1 < Repeated Individual UTRAN Priority Parameters :
    < Repeated Individual UTRAN Priority Parameters struct >> } ** 0 ;

< Repeated Individual UTRAN Priority Parameters struct > ::=
  { 0 { 1 < FDD-ARFCN : bit (14) > } ** 0 | 1 { 1 < TDD-ARFCN : bit (14) > } ** 0 }
  < UTRAN_PRIORITY : bit(3) > ;

< E-UTRAN Individual Priority Parameters Description struct > ::=
  { 0 | 1 < DEFAULT_E-UTRAN_PRIORITY : bit(3) > }
  { 1 < Repeated Individual E-UTRAN Priority Parameters :
    < Repeated Individual E-UTRAN Priority Parameters struct >> } ** 0 ;

< Repeated Individual E-UTRAN Priority Parameters struct > ::=
  { 1 < EARFCN : bit (16) > } ** 0
  < E-UTRAN_PRIORITY : bit(3) > ;

```



**Table 12.50.2: Individual priorities information element details**

<p><b>GERAN_PRIORITY</b> (3 bit field)  <b>UTRAN_PRIORITY</b> (3 bit field)  <b>E-UTRAN_PRIORITY</b> (3 bit field)</p> <p>These fields are used for the inter-RAT cell re-selection algorithm based on priority information, see sub-clauses 12.51, 12.52 and 12.53.</p> <p><b>DEFAULT_UTRAN_PRIORITY</b> (3 bit field)  <b>DEFAULT_E-UTRAN_PRIORITY</b> (3 bit field)</p> <p>The <b>DEFAULT_UTRAN_PRIORITY</b> field is encoded as the <b>UTRAN_PRIORITY</b> field; the <b>DEFAULT_E-UTRAN_PRIORITY</b> field is encoded as the <b>E-UTRAN_PRIORITY</b> field. Any UTRAN frequency contained in the 3G Frequency list and not explicitly listed in any occurrence of the <i>Repeated Individual UTRAN Priority Parameters</i> IE or any E-UTRAN frequency contained in the E-UTRAN Neighbour Cell list and not explicitly listed in any occurrence of the <i>Repeated Individual E-UTRAN Priority Parameters</i> IE shall be assigned the corresponding default value. If the <i>Repeated Individual UTRAN Priority Parameters</i> IE is not present, every UTRAN frequency in the 3G Frequency list for the serving cell shall be assigned the default value. If the <i>Repeated Individual E-UTRAN Priority Parameters</i> IE is not present, every E-UTRAN frequency in the E-UTRAN Neighbour Cell list for the serving cell shall be assigned the default value.</p>																
<p><b>FDD-ARFCN</b> (14 bit field)  <b>TDD-ARFCN</b> (14 bit field)  <b>EARFCN</b> (16 bit field)</p> <p>These fields are used to indicate the frequencies for which priorities are provided, see sub-clauses 11.2.21b and 12.53.</p>																
<p><b>T3230 timeout value</b> (3 bit field)</p> <p>The timer uses 3 bits to indicate the time for which the signalled individual priorities are valid:</p> <table> <tr><td>0 0 0</td><td>5 minute timeout;</td></tr> <tr><td>0 0 1</td><td>10 minute timeout;</td></tr> <tr><td>0 1 0</td><td>20 minute timeout;</td></tr> <tr><td>0 1 1</td><td>30 minute timeout;</td></tr> <tr><td>1 0 0</td><td>60 minute timeout;</td></tr> <tr><td>1 0 1</td><td>120 minute timeout;</td></tr> <tr><td>1 1 0</td><td>180 minute timeout;</td></tr> <tr><td>1 1 1</td><td>reserved for future use; if received, it shall be interpreted by the mobile station as "110";</td></tr> </table> <p>If this information element is not present, the mobile station shall consider the signalled individual priorities to be valid until the occurrence of one of the conditions specified in subclause 5.5.1.1c.3.</p>	0 0 0	5 minute timeout;	0 0 1	10 minute timeout;	0 1 0	20 minute timeout;	0 1 1	30 minute timeout;	1 0 0	60 minute timeout;	1 0 1	120 minute timeout;	1 1 0	180 minute timeout;	1 1 1	reserved for future use; if received, it shall be interpreted by the mobile station as "110";
0 0 0	5 minute timeout;															
0 0 1	10 minute timeout;															
0 1 0	20 minute timeout;															
0 1 1	30 minute timeout;															
1 0 0	60 minute timeout;															
1 0 1	120 minute timeout;															
1 1 0	180 minute timeout;															
1 1 1	reserved for future use; if received, it shall be interpreted by the mobile station as "110";															

## 12.51 GSM Priority Parameters

This information element is sent to provide priority information about the serving cell and other GSM cells.

**Table 12.51.1: GSM priority parameters information element**

<p>&lt; GSM Priority Parameters IE &gt; ::=</p> <ul style="list-style-type: none"> <li>&lt; <b>GERAN_PRIORITY</b> : bit(3) &gt;</li> <li>&lt; <b>THRESH_Priority_Search</b> : bit(4) &gt;</li> <li>&lt; <b>THRESH_GSM_low</b> : bit(4) &gt;</li> <li>&lt; <b>H_PRIO</b> : bit(2) &gt;</li> <li>&lt; <b>T_Reselection</b> : bit(2) &gt;;</li> </ul>
--

**Table 12.51.2: GSM priority parameters information element details**

**GERAN\_PRIORITY** (3 bit field)  
**THRESH\_Priority\_Search** (4 bit field)  
**THRESH\_GSM\_low** (4 bit field)  
**H\_PRIO** (2 bit field)  
**T\_Reselection** (2 bit field)  
 These fields are used for the inter-RAT cell re-selection algorithm based on priority, as defined in 3GPP TS 45.008.

## 12.52 3G Priority Parameters

This information element is sent to provide priority information about neighbouring UTRAN cells.

**Table 12.52.1: 3G priority parameters information element**

```
< 3G Priority Parameters IE > ::=
  { 0 | 1 < DEFAULT_UTRAN_PRIORITY : bit(3) >
    < DEFAULT_THRESH_UTRAN: bit(5) >
    < DEFAULT_UTRAN_QRXLEVMIN: bit(5) > }
  { 1 < Repeated UTRAN Priority Parameters : < Repeated UTRAN Priority Parameters struct >> } ** 0 ;

< Repeated UTRAN Priority Parameters struct > ::=
  { 1 < UTRAN_FREQUENCY_INDEX : bit (5) > } ** 0
  { 0 | 1 < UTRAN_PRIORITY : bit(3) > }
  < THRESH_UTRAN_high: bit(5) >
  { 0 | 1 < THRESH_UTRAN_low: bit(5) > }
  { 0 | 1 < UTRAN_QRXLEVMIN: bit(5) > } ;
```

**Table 12.52.2: 3G priority parameters information element details**

**DEFAULT\_UTRAN\_PRIORITY** (3 bit field)  
**DEFAULT\_THRESH\_UTRAN** (5 bit field)  
**DEFAULT\_UTRAN\_QRXLEVMIN** (5 bit field)  
 These fields are used for the inter-RAT cell re-selection algorithm based on priority, as defined in 3GPP TS 45.008. Any UTRAN frequency added or modified in the Packet Measurement Order message (full set of instances) and not explicitly listed in the Repeated UTRAN Priority Parameters structure shall be assigned these default parameter values. The value of **DEFAULT\_THRESH\_UTRAN** shall apply to both **THRESH\_UTRAN\_high** and **THRESH\_UTRAN\_low**.

### Repeated UTRAN Priority Parameters

**UTRAN\_FREQUENCY\_INDEX** (5 bit field)  
 This field is an index into the 3G Frequency list (see sub-clause 5.6.3.7b).

**UTRAN\_PRIORITY** (3 bit field)  
**THRESH\_UTRAN\_high** (5 bit field)  
**THRESH\_UTRAN\_low** (5 bit field)  
**UTRAN\_QRXLEVMIN** (5 bit field)

These fields are used for the inter-RAT cell re-selection algorithm based on priority, as defined in 3GPP TS 45.008. These parameters apply to each UTRAN frequency indexed within the structure.

If **THRESH\_UTRAN\_low** is not present, then **THRESH\_UTRAN\_low** shall take on the same value as **THRESH\_UTRAN\_high**.

Any parameter present overwrites any old data held by the mobile station for these parameters.

## 12.53 E-UTRAN Parameters

This information element is sent to provide information about E-UTRAN frequencies and priority information about neighbouring E-UTRAN cells.

**Table 12.53.1: E-UTRAN parameters information element**

```

< E-UTRAN Parameters IE > ::=
  < E-UTRAN_CCN_ACTIVE : bit >
  { 0 | 1 < GPRS E-UTRAN Measurement Parameters :
    < GPRS E-UTRAN Measurement Parameters struct >> }
  { 1 < Repeated E-UTRAN Neighbour Cells : < Repeated E-UTRAN Neighbour Cells struct >> } ** 0
  { 1 < Repeated E-UTRAN Not Allowed Cells : < Repeated E-UTRAN Not Allowed Cells struct >> } ** 0
  { 1 < Repeated E-UTRAN PCID to TA mapping : < Repeated E-UTRAN PCID to TA mapping struct >> } ** 0 ;

< GPRS E-UTRAN Measurement Parameters struct > ::=
  < Qsearch_P_E-UTRAN : bit(4) >
  < E-UTRAN_REP_QUANT : bit >
  < E-UTRAN_MULTIRAT_REPORTING : bit(2) >
  { 0 | 1 < E-UTRAN_FDD_REPORTING_THRESHOLD : bit(3) >
    { 0 | 1 < E-UTRAN_FDD_REPORTING_THRESHOLD_2 : bit(6) > }
    { 0 | 1 < E-UTRAN_FDD_REPORTING_OFFSET : bit(3) > } }
  { 0 | 1 < E-UTRAN_TDD_REPORTING_THRESHOLD : bit(3) >
    { 0 | 1 < E-UTRAN_TDD_REPORTING_THRESHOLD_2 : bit(6) > }
    { 0 | 1 < E-UTRAN_TDD_REPORTING_OFFSET : bit(3) > } } ;

< Repeated E-UTRAN Neighbour Cells struct > ::=
  { 1 < EARFCN : bit (16) >
    { 0 | 1 < Measurement Bandwidth : bit (3) > } } ** 0
  { 0 | 1 < E-UTRAN_PRIORITY : bit(3) > }
  < THRESH_E-UTRAN_high : bit(5) >
  { 0 | 1 < THRESH_E-UTRAN_low : bit(5) > }
  { 0 | 1 < E-UTRAN_QRXLEVMIN : bit(5) > } ;

< Repeated E-UTRAN Not Allowed Cells struct > ::=
  < Not Allowed Cells : < PCID Group IE >>
  { 1 < E-UTRAN_FREQUENCY_INDEX : bit(3) > } ** 0 ;

< Repeated E-UTRAN PCID to TA mapping struct > ::=
  { 1
    < PCID to TA mapping : < PCID Group IE >>
  } ** 0
  { 1 < E-UTRAN_FREQUENCY_INDEX : bit(3) > } ** 0 ;

```

-- each repetition corresponds to a different TA  
-- group of PCIDs belonging to the same TA

**Table 12.53.2: E-UTRAN parameters information element details**

### E-UTRAN\_CCN\_ACTIVE (1 bit field)

This field indicates whether CCN is enabled towards E-UTRAN neighbouring cells. It is coded as follows:

0 The broadcast E-UTRAN\_CCN\_ACTIVE parameter shall apply if available. Otherwise, CCN towards E-UTRAN cells is disabled in the cell.

1 CCN towards E-UTRAN cells is enabled in the cell.

**GPRS E-UTRAN Measurement Parameters****Qsearch\_P\_E-UTRAN** (4 bit field)**E-UTRAN\_REP\_QUANT** (1 bit field)**E-UTRAN\_MULTIRAT\_REPORTING** (2 bit field)**E-UTRAN\_FDD\_REPORTING\_THRESHOLD** (3 bit field)**E-UTRAN\_FDD\_REPORTING\_THRESHOLD\_2** (6 bit field)**E-UTRAN\_FDD\_REPORTING\_OFFSET** (3 bit field)**E-UTRAN\_TDD\_REPORTING\_THRESHOLD** (3 bit field)**E-UTRAN\_TDD\_REPORTING\_THRESHOLD\_2** (6 bit field)**E-UTRAN\_TDD\_REPORTING\_OFFSET** (3 bit field)

These fields control the measurement and reporting of E-UTRAN cells, as defined in 3GPP TS 45.008.

If both TDD and FDD frequencies are provided in the Repeated E-UTRAN Neighbour Cells IE and the E-UTRAN reporting thresholds are present for only one mode (i.e. TDD or FDD), then the parameter values for both modes shall be interpreted as having the same values.

If any of these parameters is included in more than one instance of the PACKET MEASUREMENT ORDER message, the value of the parameter in the instance with the highest PMO\_INDEX shall be used.

**Repeated E-UTRAN Neighbour Cells**

If E-UTRAN cells or frequencies are included in the neighbour cell list, this information element may be included in the message.

**EARFCN** (16 bit field)

This field specifies the E-UTRA Absolute Radio Frequency Channel Number as defined in 3GPP TS 36.104.

**Measurement Bandwidth** (3 bit field)

This field specifies the minimum value of the channel bandwidth of all valid E-UTRAN cells on the specified EARFCN. It is defined by the parameter Transmission Bandwidth Configuration,  $N_{RB}$  (see 3GPP TS 36.104). The values indicate the number of resource blocks over which the mobile station could measure if the mobile station does not support wideband RSRQ measurements (see 3GPP TS 24.008). A mobile station supporting wideband RSRQ measurements shall measure over the indicated number of resource blocks. The field is coded according to the following table:

bit

3 2 1

0 0 0  $N_{RB} = 6$ 0 0 1  $N_{RB} = 15$ 0 1 0  $N_{RB} = 25$ 0 1 1  $N_{RB} = 50$ 1 0 0  $N_{RB} = 75$ 1 0 1  $N_{RB} = 100$ 

All others Reserved for future use. If received by the mobile station, it shall be interpreted as '101'.

When missing, this indicates  $N_{RB} = 6$ .

**E-UTRAN\_PRIORITY** (3 bit field)**THRESH\_E-UTRAN\_high** (5 bit field)**THRESH\_E-UTRAN\_low** (5 bit field)

If THRESH\_E-UTRAN\_low is not present, then THRESH\_E-UTRAN\_low shall take on the same value as THRESH\_E-UTRAN\_high.

**E-UTRAN\_QRXLEVMIN** (5 bit field)

These fields are used for the inter-RAT cell re-selection algorithm based on priority, as defined in 3GPP TS 45.008. These values apply to each of the EARFCN values listed within this structure.

**Repeated E-UTRAN Not Allowed Cells struct**

This structure identifies Not Allowed Cells with zero or more corresponding E-UTRAN frequency indices. If no E-UTRAN\_FREQUENCY\_INDEX is present, the Not Allowed Cells IE is applicable to all E-UTRAN frequencies specified in the Repeated E-UTRAN Neighbour Cells struct(s).

**E-UTRAN\_FREQUENCY\_INDEX (3 bit field)**

This field contains the index into the frequencies specified as part of the E-UTRAN Neighbour Cell list. A value of 0 refers to the first E-UTRAN frequency (EARFCN) defined in the list. A value of 1 refers to the second defined frequency and so on.

**Not Allowed Cells**

This information element identifies one or more E-UTRAN cells by means of their physical layer cell identities (see 3GPP TS 36.211). The mobile station shall not perform measurements or attempt reselection to these cells. This information element is defined as the PCID Group IE described in subclause 12.57.

**PCID to TA mapping**

This information element identifies, on the frequency or frequencies that this information element is associated with, one or more E-UTRAN cells by means of their physical layer cell identities (see 3GPP TS 36.211) that belong to the same Tracking Area. If no PCIDs or groups of PCIDs are indicated within this structure, then all PCIDs belong to the same Tracking Area.

This information element is defined as the PCID Group IE described in 3GPP TS 44.060.

## 12.54 3G CSG Description

The *3G CSG Description* information element contains the description of 3G CSG cells. The fields of this description are used for inter-RAT cell reselection to UTRAN CSG cells as defined in 3GPP TS 45.008.

**Table 12.54.1: 3G CSG Description information element**

```
< 3G CSG Description IE > ::=
  { 1 < CSG_PSC_SPLIT : < PSC Group IE >>
    { 1 < UTRAN_FREQUENCY_INDEX : bit (5) > } ** 0 } ** 0 ;
```

**Table 12.54.2: 3G CSG Description information element details**

**UTRAN\_FREQUENCY\_INDEX (5 bit field)**

Each instance of this field describes a UTRAN frequency in the 3G Neighbour Cell list where the CSG PSC SPLIT is valid. If the CSG\_PSC\_SPLIT IE is present but there are no instances of this field present in the message, then the CSG PSC SPLIT shall apply to all UTRAN frequencies in the 3G Neighbour Cell list. This field is described in sub-clause 12.52.

**CSG\_PSC\_SPLIT**

This information element identifies one or more primary scrambling code values for UTRAN FDD cells (see 3GPP TS 25.213) or cell parameter values for UTRAN TDD cells (see 3GPP TS 25.223) as being reserved for CSG cells. The range of reserved primary scrambling codes or cell parameters applies to all UTRAN frequencies specified in the list of frequencies.

This information element is defined as the PSC Group IE described in subclause 12.58.

## 12.55 E-UTRAN CSG Description

The *E-UTRAN CSG Description* information element contains the description of E-UTRAN CSG cells. The fields of this description are used for inter-RAT cell reselection to E-UTRAN CSG cells as defined in 3GPP TS 45.008.

**Table 12.55.1: E-UTRAN CSG description information element**

```
< E-UTRAN CSG Description IE > ::=
  { 1 < CSG_PCI_SPLIT : < PCID Group IE >>
    { 1 < E-UTRAN_FREQUENCY_INDEX : bit (3) > } ** 0 } ** 0 ;
```

**Table 12.55.2: E-UTRAN CSG description information element details**

### E-UTRAN\_FREQUENCY\_INDEX (3 bit field)

Each instance of this field describes an E-UTRAN frequency in the E-UTRAN Neighbour Cell list where the CSG PCI SPLIT is valid. If the CSG\_PCI\_SPLIT information element is present but there are no instances of this field present in the message, then the CSG PCI SPLIT shall apply to all E-UTRAN frequencies in the E-UTRAN Neighbour Cell list. This field is described in sub-clause 12.53.

### CSG\_PCI\_SPLIT

This information element identifies one or more E-UTRAN physical layer cell identities (see 3GPP TS 36.211) as being reserved for CSG cells. The range of reserved physical layer cell identities applies to all E-UTRAN frequencies specified in the list of frequencies. This information element is defined as the PCID Group IE in sub-clause 12.57.

## 12.56 Measurement Control Parameters Description

This information element is sent to provide the measurement control information about UTRAN frequencies and E-UTRAN frequencies. The fields of this description are used for inter-RAT cell measurement.

**Table 12.56.1: Measurement control parameters description information element**

```
< Measurement Control Parameters Description > ::=
  { 0 | 1 < Measurement_Control_E-UTRAN : bit(1) >
    < E-UTRAN_FREQUENCY_INDEX : bit (3) >
    { 1 < E-UTRAN_FREQUENCY_INDEX : bit (3) > } ** 0
  }
  { 0 | 1 < Measurement_Control_UTRAN : bit(1) >
    < UTRAN_FREQUENCY_INDEX : bit (5) >
    { 1 < UTRAN_FREQUENCY_INDEX : bit (5) > } ** 0
  }
  ;
```

**Table 12.56.2: Measurement control parameters description information element details**

### Measurement\_Control\_E-UTRAN (1 bit field)

This field controls the measurement of E-UTRAN cells for the specified EARFCNs indicated by the E-UTRAN\_FREQUENCY\_INDEX values, as defined in 3GPP TS 45.008. If this field is not present, all EARFCNs in the E-UTRAN Neighbour Cell list shall behave according to the behaviour controlled by the Qsearch\_P\_E-UTRAN.

All E-UTRAN frequency indices received in this instance of the information element shall take the value of parameter Measurement\_Control\_E-UTRAN. All other E-UTRAN frequency indices in the E-UTRAN Neighbour Cell list shall take the opposite value to that of the received Measurement\_Control\_E-UTRAN.

### E-UTRAN\_FREQUENCY\_INDEX (3 bit field)

This field is described in sub-clause 12.53.

**Measurement\_Control\_UTRAN** (1 bit field)

This field controls the measurement of UTRAN cells for the specified UARFCNs indicated by the UTRAN\_FREQUENCY\_INDEX values, as defined in 3GPP TS 45.008. If this field is not present, all UARFCNs in 3G Neighbour Cell list shall behave according to the behaviour controlled by the Qsearch\_P.

All UTRAN frequency indices received in this instance of the information element shall take the value of parameter Measurement\_Control\_UTRAN. All other UTRAN frequency indices in the 3G Neighbour Cell list shall take the opposite value to that of the received Measurement\_Control\_UTRAN.

**UTRAN\_FREQUENCY\_INDEX** (5 bit field)

This field is described in sub-clause 12.52.

## 12.57 PCID Group

The *PCID Group* information element contains the description of a group of one or more physical layer cell identities for E-UTRAN cells (see 3GPP TS 36.211).

**Table 12.57.1: PCID Group information element**

```
< PCID Group IE > ::=
{ 1 < PCID : bit (9) > } ** 0 -- explicit PCID coding
{ 0 | 1 < PCID_BITMAP_GROUP : bit (6) > }
{ 1 < PCID_Pattern_length : bit (3) >
  < PCID_Pattern : bit (val(PCID_Pattern_length + 1)) >
  < PCID_pattern_sense : bit (1) >
} ** 0;
```

**Table 12.57.2: PCID Group information element details**

**PCID** (9 bit field)

This field specifies the physical layer cell identity of a single E-UTRAN cell.

**PCID\_BITMAP\_GROUP** (6 bit field)

Each bit number  $n$ , where  $n$  can take the value from 1 to 6, represents the group of PCID values in the range  $(n-1) * 84$  to  $(n*84)-1$  inclusive.

When this field is received as part of the Not Allowed Cells IE, if bit number  $n$  is set to '1', then all cells whose PCID belongs to the group identified by that bit are not allowed; correspondingly, if bit number  $n$  is set to '0', then all cells whose PCID belongs to that group are allowed.

When this field is received as part of the CSG\_PCI\_SPLIT IE, if bit number  $n$  is set to '1', then all cells whose PCID belongs to the group identified by that bit are part of the CSG; correspondingly, if bit number  $n$  is set to '0', then all cells whose PCID belongs to that group are not part of the CSG.

When this field is received as part of the PCID to TA mapping IE, if bit number  $n$  is set to '1', then all cells whose PCID belongs to the group identified by that bit are part of the same TA, correspondingly, if bit number  $n$  is set to '0', then all cells whose PCID belongs to that group are not part of the same TA.

**PCID\_Pattern\_length** (3 bit field)**PCID\_Pattern****PCID\_pattern\_sense** (1 bit field)

If the PCID\_pattern\_sense bit is equal to '0' then the group of identified cells are those where the most significant bits of the physical layer cell identity are equal to "PCID\_pattern". If the PCID\_pattern\_sense bit is equal to '1' then the group of identified cells is all those where the most significant bits of the physical layer cell identity are not equal to the PCID\_pattern.

## 12.58 PSC Group

The *PSC Group* information element contains the description of a group of one or more primary scrambling codes for UTRAN FDD cells (see 3GPP TS 25.213) or a group of one or more cell parameters for UTRAN TDD cells (see 3GPP TS 25.223).

**Table 12.58.1: PSC Group information element**

```
< PSC Group IE > ::=
{ 1 < PSC : bit (9) > } ** 0          -- explicit PSC coding
{ 1 < PSC_Pattern_length : bit (3) >
  < PSC_Pattern : bit (val(PSC_Pattern_length + 1)) >
  < PSC_pattern_sense : bit (1) >
} ** 0 ;
```

**Table 12.58.2: PSC Group information element details**

### PSC (9 bit field)

This field specifies the primary scrambling code of a single FDD cell or the cell parameter of a single TDD cell. For TDD cells, the Cell Parameter is contained in the 7 least significant bits of the field; the 2 most significant bits are ignored.

### PSC\_Pattern\_length (3 bit field)

### PSC\_Pattern

### PSC\_pattern\_sense (1 bit field)

If the PSC\_pattern\_sense bit is equal to '0' then the group of identified codes are those where the most significant bits of the primary scrambling code or the cell parameter are equal to "PSC\_pattern". If the PSC\_pattern\_sense bit is equal to '1' then the group of identified codes is all those where the most significant bits of the primary scrambling code or cell parameter are not equal to the PSC\_pattern. For TDD frequencies, if the pattern contains more than 6 bits only the most significant 6 bits shall be used.

## 12.59 Enhanced Cell Reselection Parameters

This information element is sent to provide information about parameters for enhanced cell reselection procedures towards E-UTRAN cells, see 3GPP TS 45.008.

**Table 12.59.1: Enhanced Cell Reselection Parameters information element**

```
< Enhanced Cell Reselection Parameters IE > ::=
{ 1 < Repeated E-UTRAN Enhanced Cell Reselection Parameters :
  < Repeated E-UTRAN Enhanced Cell Reselection Parameters struct >> } ** 0 ;

< Repeated E-UTRAN Enhanced Cell Reselection Parameters struct > ::=
{ 1 < E-UTRAN_FREQUENCY_INDEX : bit (3) > } ** 0
{ 0                                     -- reselection based on target cell RSRP (RSRQ checked for suitability)
  < E-UTRAN_Qmin : bit(4) >
| 1                                     -- reselection based on target cell RSRQ (RSRP checked for suitability)
  < THRESH_E-UTRAN_high_Q : bit(5) >
  { 0 | 1 < THRESH_E-UTRAN_low_Q : bit(5) > }
  { 0 | 1 < E-UTRAN_QQUALMIN : bit(4) > }
  { 0 | 1 < E-UTRAN_RSRPmin : bit(5) > }
};
```



**Table 12.59.2: Enhanced Cell Reselection Parameters information element details****Repeated E-UTRAN Enhanced Cell Reselection Parameters struct****E-UTRAN\_FREQUENCY\_INDEX** (3 bit field)

This field is defined in sub-clause 12.53.

**E-UTRAN\_Qmin** (4 bit field)**E-UTRAN\_QUALMIN** (4 bit field)**E-UTRAN\_RSRPmin** (5 bit field)**THRESH\_E-UTRAN\_high\_Q** (5 bit field)**THRESH\_E-UTRAN\_low\_Q** (5 bit field)

These fields are used for the inter-RAT cell re-selection algorithm based on priority, as defined in 3GPP TS 45.008. The parameters apply to each E-UTRAN frequency indexed within this structure. Any parameter present overwrites any old data held by the mobile station for these parameters.

If THRESH\_E-UTRAN\_low\_Q is not present, then THRESH\_E-UTRAN\_low\_Q shall take on the same value as THRESH\_E-UTRAN\_high\_Q.

## 12.60 E-UTRAN CSG Measurement Report

The *E-UTRAN CSG Measurement Report* information element contains measurement results for one E-UTRAN CSG or hybrid neighbour cell identified via its Cell Identity.

**Table 12.60.1: E-UTRAN CSG Measurement Report information element**

```

< E-UTRAN CSG Measurement Report IE > ::=
  < E-UTRAN CI : bit (28) >
  < Tracking Area Code : bit (16) >
  { 0 | 1 < PLMN-ID : < PLMN-ID struct > > }
  < CSG-ID : bit (27) >
  < Access Mode : bit (1) >
  < REPORTING_QUANTITY : bit (6) > ;

< PLMN-ID struct > ::=
  < MCC : bit (12) >
  < MNC : bit (12) > ;

```

**Table 12.60.2: E-UTRAN CSG Measurement Report information element details**

<p><b>E-UTRAN CGI</b> (28 bit field) This field contains the E-UTRAN Cell Identity (as defined in 3GPP TS 23.003) of the cell being reported.</p> <p><b>Tracking Area Code</b> (16 bit field) This field contains the tracking area code (as defined in 3GPP TS 24.301) of the cell being reported.</p> <p><b>PLMN-ID</b> This information element contains the primary PLMN-ID of the cell being reported (as defined in 3GPP TS 36.331). If this field is not present then the PLMN-ID of the target cell is the same as that of the serving cell.</p> <p><b>CSG-ID</b> (27 bit field) This field contains the CSG identity (as defined in 3GPP TS 23.003) of the cell being reported.</p> <p><b>Access Mode</b> (1 bit field) This field indicates the access mode of the reported cell. It is coded as follows: 0 The reported cell is a closed access mode cell. 1 The reported cell is a hybrid access mode cell.</p> <p><b>REPORTING_QUANTITY</b> (6 bit field) This is the reporting quantity for E-UTRAN cell identified by the E-UTRAN Global Cell Identity. The quantities are defined in 3GPP TS 45.008 for the respective Radio Access mode.</p>
<p><b>PLMN-ID struct</b></p> <p><b>MCC</b> (12 bit field) This field contains the Mobile Country Code of the PLMN of the cell being reported.</p> <p><b>MNC</b> (12 bit field) This field contains the Mobile Network Code of the PLMN of the cell being reported.</p>

## 12.61 UTRAN CSG Measurement Report

The *UTRAN CSG Measurement Report* information element contains measurement results for a single UTRAN CSG or hybrid neighbour cell identified via its Cell Global Identity.

**Table 12.61.1: UTRAN CSG Measurement Report information element**

<pre> &lt; UTRAN CSG Measurement Report IE &gt; ::=   &lt; UTRAN CGI : bit (28) &gt;   { 0   1 &lt; PLMN-ID : &lt; PLMN-ID struct &gt; &gt; }   &lt; CSG-ID : bit (27) &gt;   &lt; Access Mode : bit (1) &gt;   &lt; REPORTING_QUANTITY : bit (6) &gt; ;  &lt; PLMN-ID struct &gt; ::=   &lt; MCC : bit (12) &gt;   &lt; MNC : bit (12) &gt; ; </pre>
---

**Table 12.61.2: UTRAN CSG Measurement Report information element details**

<p><b>UTRAN CI</b> (28 bit field) This field contains the Cell Identity (as defined in 3GPP TS 25.331) of the cell being reported.</p> <p><b>PLMN-ID</b> This information element contains the primary PLMN-ID of the cell being reported (as defined in 3GPP TS 25.331). If this field is not present then the PLMN-ID of the target cell is the same as that of the serving cell.</p> <p><b>CSG-ID</b> (27 bit field) This field contains the CSG identity (as defined in 3GPP TS 23.003) of the cell being reported.</p> <p><b>Access Mode</b> (1 bit field) This field indicates the access mode of the reported cell. It is coded as follows: 0 The reported cell is a closed access mode cell. 1 The reported cell is a hybrid access mode cell.</p> <p><b>REPORTING_QUANTITY</b> (6 bit field) This is the reporting quantity for UTRAN cell identified by the UTRAN Global Cell Identity. The quantities are defined in 3GPP TS 45.008 for the respective Radio Access mode.</p>
<p><b>PLMN-ID struct</b></p> <p><b>MCC</b> (12 bit field) This field contains the Mobile Country Code of the PLMN of the cell being reported.</p> <p><b>MNC</b> (12 bit field) This field contains the Mobile Network Code of the PLMN of the cell being reported.</p>

## 12.62 E-UTRAN CSG Target cell

The *E-UTRAN CSG Target cell* information element contains the description of an E-UTRAN CSG Target cell.

**Table 12.62.1: E-UTRAN CSG Target cell information element**

<pre>&lt; E-UTRAN CSG Target cell IE &gt; ::=   &lt;E- UTRAN CI : bit (28) &gt;   &lt; Tracking Area Code : bit (16) &gt;   { 0   1 &lt; PLMN-ID : &lt; PLMN-ID struct &gt; &gt; } ;</pre>
<pre>&lt; PLMN-ID struct &gt; ::=   &lt; MCC : bit (12) &gt;   &lt; MNC : bit (12) &gt; ;</pre>

**Table 12.62.2: E-UTRAN CSG Target cell information element details**

<p><b>E-UTRAN CI</b> (28 bit field) This field contains the E-UTRAN Cell Identity (as defined in 3GPP TS 23.003) of the target cell.</p>
<p><b>Tracking Area Code</b> (16 bit field) This field contains the tracking area code (as defined in 3GPP TS 24.301) of the target cell.</p>
<p><b>PLMN-ID</b> This information element contains the PLMN-ID of the target cell. If this field is not present then the PLMN-ID of the target cell is the same as that of the serving cell.</p>

***PLMN-ID struct*****MCC** (12 bit field)

This field contains the Mobile Country Code of the PLMN of the cell being reported.

**MNC** (12 bit field)

This field contains the Mobile Network Code of the PLMN of the cell being reported.

## 12.63 UTRAN CSG Target cell

The *UTRAN CSG Target cell* information element contains the description of a UTRAN CSG Target cell.

**Table 12.63.1: UTRAN CSG Target cell information element**

```
< UTRAN CSG Target cell IE > ::=
  < UTRAN CI : bit (28) >
  { 0 | 1 < PLMN-ID : < PLMN-ID struct > > } ;
```

```
< PLMN-ID struct > ::=
  < MCC : bit (12) >
  < MNC : bit (12) > ;
```

**Table 12.63.2: UTRAN CSG Target cell information element details**

**UTRAN CI** (28 bit field)

This field contains the Cell Identity (as defined in 3GPP TS 25.331) of the target cell.

**PLMN-ID**

This information element contains the PLMN-ID of the target cell. If this field is not present then the PLMN-ID of the target cell is the same as that of the serving cell.

***PLMN-ID struct*****MCC** (12 bit field)

This field contains the Mobile Country Code of the PLMN of the cell being reported.

**MNC** (12 bit field)

This field contains the Mobile Network Code of the PLMN of the cell being reported.

## 12.64 DTM Handover PS Radio Resources 3

This information element provides the radio resources assigned for PS services in the new cell and is included within the DTM HANDOVER COMMAND message and can only be used when EMSR or extended TSC sets (see 3GPP TS 45.002 [32]) is supported by the mobile station.

Table 12.64.1: DTM Handover PS Radio Resources 3 information element

```

< DTM Handover PS Radio Resources 3 IE > ::=
  < Cell Identification : < Cell Identification IE > >           --- provided by SI/PSI for PS HO
  < MAX_LAPDm : bit (3) >                                     --- needed for DTM in new cell
  < GPRS_MS_TXPWR_MAX_CCH : bit (5) >                       --- needed for DTM in new cell
  < GPRS Cell Options : < GPRS Cell Options IE > >         --- provided by SI/PSI for PS HO
  < GPRS Power Control Parameters : < GPRS Power Control Parameters IE > > --- provided by SI/PSI for PS HO
  < RLC_RESET : bit (1) >
  { 00 < EGPRS mode : < EGPRS mode 2 IE > >
  ! < TBF mode error: { 01 | 10 | 11 } bit(*) = < no string > > } -- reserved for future use

  -- Optional extension information:
  { 0 | 1 < Extension Length : bit (8) >
    < bit (val(Extension Length) + 1)
    & { < Extension Information > ! { bit ** = < no string > } } > };

< Extension Information > ::=
  { {
    -- Rel-10 extension:
    { 0 < EMST_NW_Capability : bit (1) >   -- EMST is not used
      | 1                                   -- EMST is used
      { 0
        | 1 < Downlink RLC Entity 2 : < RLC Entity struct >
          { 0
            | 1 < Downlink RLC Entity 3 : < RLC Entity struct > }
          }
        { 0
          | 1 < Uplink RLC Entity 2 : < RLC Entity struct >
            { 0
              | 1 < Uplink RLC Entity 3 : < RLC Entity struct > }
            }
          }
        }
      { 0 | 1 MTTI_DOWNLINK_ASSIGNMENT_C1 : bit (1) }
      { 0 | 1 MTTI_DOWNLINK_ASSIGNMENT_C2 : bit (1) }
      { 0 | 1 MTTI_UPLINK_ASSIGNMENT_C1 : bit(1) }
      { 0 | 1 MTTI_UPLINK_ASSIGNMENT_C2 : bit(1) }
      { 0   -- EMSR is not enabled in downlink
        | 1   -- EMSR is enabled in downlink
        { 1 < EMSR Additional PFCs 1 : < Additional PFCs struct > > } ** 0
        { 1 < EMSR Additional PFCs 2 : < Additional PFCs struct > > } ** 0
        { 1 < EMSR Additional PFCs 3 : < Additional PFCs struct > > } ** 0
        }
      { 0   -- EMSR is not enabled in uplink
        | 1   -- EMSR is enabled in uplink
        { 1 < EMSR Additional PFCs 1 : < Additional PFCs struct > > } ** 0
        { 1 < EMSR Additional PFCs 2 : < Additional PFCs struct > > } ** 0
        { 1 < EMSR Additional PFCs 3 : < Additional PFCs struct > > } ** 0
        }
      }
    }
  }
  {
    -- Rel-11 extension:
    < EGPRS Packet Downlink Ack/Nack Type 3 Support : bit(1) >
  }
  {
    -- Rel-12 extension:
    { 0 | 1   -- Primary DL TSC Value assigned
      < Primary TSC Set : bit (1) >
      < Primary TSC Value : bit (3) > }
    { 0 | 1   -- Secondary DL TSC Value assigned
      < Secondary DL TSC Set : bit (1) >
      < Secondary DL TSC Value : bit (3) > }
  }
  < spare bit > ** } // ;
  -- Extension information may be truncated between released versions of the protocol.
  -- The receiver shall assume the value zero for any truncated bit.

< RLC Entity struct > ::=
  < TFI : bit (5) >
  < RLC_MODE : bit (1) >
  { 0 | 1 < EGPRS Window Size : < EGPRS Window Size IE > > }
  < PFI : bit (7) >;

```

```

< Additional PFCs struct > ::=
  < TFI : bit (5) >
  { 0 | 1 < NPM Transfer Time : bit (5) > }
  < PFI : bit (7) >;

```

**Table 12.64.2: DTM Handover PS Radio Resources 3 information element details**

<p><b>Cell Identification</b> (information element) This information element is defined in sub-clause 12.23.</p>
<p><b>MAX_LAPDm</b> (3 bit field) This field indicates the maximum number of LAPDm frames into which a layer 3 message can be segmented sent on the main DCCH. It is coded as described in 3GPP TS 44.018.</p>
<p><b>GPRS_MS_TXPWR_MAX_CCH</b> (5 bit field) The GPRS_MS_TXPWR_MAX_CCH field is coded as the binary representation of the 'power control level' in 3GPP TS 45.005 corresponding to the maximum TX power level a mobile station may use when accessing on a packet control channel. This value shall be used by the mobile station according to 3GPP TS 45.008.</p>
<p><b>GPRS Cell Options</b> (information element) The GPRS Cell Option information element is defined in sub-clause 12.24.</p>
<p><b>GPRS Power Control Parameters</b> (information element) The GPRS Power Control Parameters information element is defined in sub-clause 12.9a.</p>
<p><b>RLC_RESET</b> (1 bit field) This field is defined in sub-clause 12.42.</p>
<p><b>EGPRS mode 2 IE</b> This information element is defined in sub-clause 12.48a.1.</p>
<p><b>EMST_NW_Capability</b> (1 bit field) See sub-clause 11.2.29 (Packet Uplink Assignment message).</p>
<p><b>TFI</b> (5 bit field) See sub-clause 11.2.31 (Packet Timeslot Reconfigure message).</p>
<p><b>RLC_MODE</b> (1 bit field) See sub-clause 11.2.31 (Packet Timeslot Reconfigure message). If the <b>RLC_RESET</b> field indicates that any given RLC entity is not reset across PS handover then the mobile station shall ignore this field and use the same RLC mode that was used for the corresponding PFC in the old cell.</p>
<p><b>EGPRS Window Size</b> This information element is defined in sub-clause 12.5.2.</p>
<p><b>PFI</b> (7 bit field) See sub-clause 11.2.31 (Packet Timeslot Reconfigure message).</p>
<p><b>NPM Transfer Time</b> (5 bit field) This field contains the NPM Transfer Time limitation for TBF or RLC entity assigned to operate in RLC non-persistent mode. If EMSR is supported this field contains the NPM Transfer Time limitation for a specific Packet Flow Context configured to use RLC non-persistent mode.</p>
<p><b>MTTI_DOWNLINK_ASSIGNMENT_C1</b> (1 bit field) <b>MTTI_DOWNLINK_ASSIGNMENT_C2</b> (1 bit field) See sub-clause 11.2.7 (Packet Downlink Assignment message).</p>
<p><b>MTTI_UPLINK_ASSIGNMENT_C1</b> (1 bit field) <b>MTTI_UPLINK_ASSIGNMENT_C2</b> (1 bit field) See sub-clause 11.2.29 (Packet Uplink Assignment message).</p>

<b>EMSR Additional PFCs 1</b> <b>EMSR Additional PFCs 2</b> <b>EMSR Additional PFCs 3</b> See sub-clause 11.2.7 (Packet Downlink Assignment message).
<b>EGPRS Packet Downlink Ack/Nack Type 3 Support</b> (1 bit field) See sub-clause 11.2.7 (Packet Downlink Assignment message).
<b>Primary TSC Set</b> (1 bit field) <b>Secondary DL TSC Set</b> (1 bit field) See sub-clause 12.46.
<b>Primary TSC Value</b> (3 bit field) See sub-clause 12.46.
<b>Secondary DL TSC Value</b> (3 bit field) See sub-clause 12.46.

## 12.65 Dynamic Allocation 3

This information element provides the description of the uplink dynamic allocation information for a BTTI or an RTTI assignment in a DLMC configuration with or without power control parameters.

**Table 12.65.1: Dynamic Allocation 3 information element**

<pre> &lt; Dynamic Allocation 3 IE &gt; ::=   &lt; EXTENDED_DYNAMIC_ALLOCATION : bit (1) &gt;   &lt; USF_GRANULARITY : bit (1) &gt;   { 0   1 &lt; ALPHA : bit (4) &gt; }   { 0   1 &lt; TSC : bit (3) &gt; }   { 0     -- BTTI mode     { 1 { 0   1 &lt; USF : bit (3) &gt;       &lt; GAMMA : bit (5) &gt; } ** 0    -- one instance provided for each assigned PDCH       1       -- RTTI mode       { 1 { 0   1 &lt; USF : bit (3) &gt;         &lt; GAMMA : bit (5) &gt;         { 0      -- RTTI USF mode             1    -- BTTI USF mode             { 0      -- same BTTI USF for each RTTI block                 1 &lt; USF_2 : bit (3) &gt; } -- BTTI USF for the 2nd RTTI block             } } ** 0    -- one instance provided for each assigned PDCH-pair           } }   }; </pre>
---

**Table 12.65.2: Dynamic Allocation 3 information element details**

<b>EXTENDED_DYNAMIC_ALLOCATION</b> (1 bit field) This information field indicates the medium access mode to be used during the TBF. 0 Dynamic Allocation 1 Extended Dynamic Allocation
<b>USF_GRANULARITY</b> (1 bit field) This information field indicates the USF granularity to be applied by the mobile station when it is assigned a TBF using Dynamic Allocation or Extended Dynamic Allocation. 0 the mobile station shall transmit one RLC/MAC block 1 the mobile station shall transmit four consecutive RLC/MAC blocks

<p><b>ALPHA</b> (4 bit field) For encoding and description see the Global Power Control Parameters IE.</p>														
<p><b>TSC</b> (3 bit field) This field is the binary representation of the training sequence code, see 3GPP TS 45.002. Range: 0 to 7. In the absence of this field the applicable TSC shall be the same as the corresponding downlink carrier.</p>														
<p><b>USF, USF_2</b> (3 bit field) These fields indicate the USF values assigned to a given TBF for the assigned timeslot or PDCH pair.</p> <p>In the case of RTTI mode with BTTI USF, the USF value specified in the USF field (respectively USF_2 field) applies to the first two (respectively second two) TDMA frames of the following basic radio block period (see sub-clauses 8.1.1.1, 8.1.1.2.1).</p> <p>These fields are encoded as a binary representation of the USF value as defined in sub-clause 10.4.1.</p> <p>The order in which USF assignments are encoded and the meaning when the number of repetitions of the USF is lower than the maximum is described in Annex K.</p>														
<p><b>GAMMA</b> (5 bit field) This field is the binary representation of the parameter <math>\Gamma_{CH}</math> for MS output power control in units of 2 dB, see 3GPP TS 45.008 [15]. The field is coded according to the following table:</p> <table> <tr> <td>bit</td> <td></td> </tr> <tr> <td>5 4 3 2 1</td> <td></td> </tr> <tr> <td>0 0 0 0 0</td> <td><math>\Gamma_{CH} = 0</math> dB</td> </tr> <tr> <td>0 0 0 0 1</td> <td><math>\Gamma_{CH} = 2</math> dB</td> </tr> <tr> <td>:::::</td> <td></td> </tr> <tr> <td>1 1 1 1 0</td> <td><math>\Gamma_{CH} = 60</math> dB</td> </tr> <tr> <td>1 1 1 1 1</td> <td><math>\Gamma_{CH} = 62</math> dB</td> </tr> </table> <p>In the case of RTTI mode with BTTI USF, exactly one GAMMA field shall be included for each PDCH pair for which either one or two USF values are assigned.</p>	bit		5 4 3 2 1		0 0 0 0 0	$\Gamma_{CH} = 0$ dB	0 0 0 0 1	$\Gamma_{CH} = 2$ dB	:::::		1 1 1 1 0	$\Gamma_{CH} = 60$ dB	1 1 1 1 1	$\Gamma_{CH} = 62$ dB
bit														
5 4 3 2 1														
0 0 0 0 0	$\Gamma_{CH} = 0$ dB													
0 0 0 0 1	$\Gamma_{CH} = 2$ dB													
:::::														
1 1 1 1 0	$\Gamma_{CH} = 60$ dB													
1 1 1 1 1	$\Gamma_{CH} = 62$ dB													

## 12.66 DLMC Channel Quality Report

This Information Element provides channel quality report information which may include UFPS, carrier or timeslot based measurement information for a mobile station in a DLMC configuration. The information to be included within this IE depends on the setting of the ES/P field and CES/P field (see sub-clause 9.1.8.2.1), the most recently received LINK\_QUALITY\_MEASUREMENT\_MODE field (see sub-clause 11.2.7) and the most recently received DLMC Measurement Type field (see sub-clause 11.2.7).



Table 12.66.1: DLMC Channel Quality Report information element

<pre> &lt; DLMC Channel Quality Report IE &gt; ::=   C_VALUE : bit (6)   { 0   1 &lt; DLMC Interference Measurements : &lt; DLMC Interference Measurement Report struct &gt;&gt; }   { 1 &lt; DLMC BEP Link Quality Measurements : &lt; DLMC BEP Link Quality Measurements struct &gt;&gt;     { 0   1 &lt; DLMC BEP MEASUREMENTS : &lt; DLMC BEP Measurements Struct &gt;&gt; } ** 0; </pre>
<pre> &lt; DLMC Interference Measurement Report Struct &gt; ::= { 0   1 &lt; I_LEVEL_TN0 : bit (4) &gt; } { 0   1 &lt; I_LEVEL_TN1 : bit (4) &gt; } { 0   1 &lt; I_LEVEL_TN2 : bit (4) &gt; } { 0   1 &lt; I_LEVEL_TN3 : bit (4) &gt; } { 0   1 &lt; I_LEVEL_TN4 : bit (4) &gt; } { 0   1 &lt; I_LEVEL_TN5 : bit (4) &gt; } { 0   1 &lt; I_LEVEL_TN6 : bit (4) &gt; } { 0   1 &lt; I_LEVEL_TN7 : bit (4) &gt; };  &lt; DLMC BEP Link Quality Measurements struct &gt; ::= { { 0   1 &lt; GMSK_MEAN_BEP : bit (5) &gt;   &lt; GMSK_CV_BEP : bit (3) &gt;}   { 0   1 &lt; 8PSK_MEAN_BEP : bit (5) &gt;   &lt; 8PSK_CV_BEP : bit (3) &gt;}   { 0   1 &lt; 16QAM_NSR_MEAN_BEP : bit (5) &gt;   &lt; 16QAM_NSR_CV_BEP : bit (3) &gt;}   { 0   1 &lt; 32QAM_NSR_MEAN_BEP : bit (5) &gt;   &lt; 32QAM_NSR_CV_BEP : bit (3) &gt;} };  &lt; DLMC BEP Measurements Struct &gt; ::= { 0     1 &lt; REPORTED_MODULATION : bit (2) &gt;   &lt; MEAN_BEP_TN0 : bit (4) &gt; } { 0     1 &lt; REPORTED_MODULATION : bit (2) &gt;   &lt; MEAN_BEP_TN1 : bit (4) &gt; } { 0     1 &lt; REPORTED_MODULATION : bit (2) &gt;   &lt; MEAN_BEP_TN2 : bit (4) &gt; } { 0     1 &lt; REPORTED_MODULATION : bit (2) &gt;   &lt; MEAN_BEP_TN3 : bit (4) &gt; } { 0     1 &lt; REPORTED_MODULATION : bit (2) &gt;   &lt; MEAN_BEP_TN4 : bit (4) &gt; } { 0     1 &lt; REPORTED_MODULATION : bit (2) &gt;   &lt; MEAN_BEP_TN5 : bit (4) &gt; } { 0     1 &lt; REPORTED_MODULATION : bit (2) &gt;   &lt; MEAN_BEP_TN6 : bit (4) &gt; } { 0     1 &lt; REPORTED_MODULATION : bit (2) &gt;   &lt; MEAN_BEP_TN7 : bit (4) &gt; }; </pre>

**Table 12.66.2: DLMC Channel Quality Report information element details**

<p><b>DLMC Interference Measurements</b></p> <p>These information elements provide interference measurement information for a MS in a DLMC configuration. The MS provides this information for the downlink carrier indicated by the assignment message or the lowest numbered downlink carrier if carrier information for interference measurements is not provided by the assignment message.</p>
<p><b>C_VALUE</b></p> <p>If the parameter PC_MEAS_CHAN (see sub-clause 12.9) indicates downlink measurements for power control shall be made on BCCH, a single instance of this field shall be reported using BCCH Carrier measurements (see 3GPP TS 45.008 [15] regarding C_VALUE determination). If PC_MEAS_CHAN indicates that the downlink measurements for power control shall be made on PDCH, a single instance of this field shall be reported for the carrier/UFPS on which the MS was polled.</p>
<p><b>DLMC BEP Link Quality Measurements</b></p> <p>If the DLMC Measurement Type field (see sub-clause 11.2.7) in the last received assignment message indicates measurement information is to be reported on a per UFPS basis the measurements are reported starting with the UFPS on which the MS was polled followed by additional higher numbered UFPS (if any) beginning with the next in sequence UFPS.</p> <p>If the DLMC Measurement Type field (see sub-clause 11.2.7) in the last received assignment message indicates measurement information is to be reported on a per carrier basis the measurements are reported starting with the carrier on which the MS was polled followed by additional higher numbered carriers (if any) beginning with the next in sequence carrier.</p> <p>The number of UFPS/carriers reported is determined by the space available in the reporting message (see sub-clause 9.1.8.2.1). If RLC/MAC blocks have not been received on a given UFPS/carrier since the last reporting period it shall still be listed in but no measurement results shall be included.</p>
<p><b>DLMC BEP_MEASUREMENTS</b></p> <p>This field is included when the DLMC Measurement Type field (see sub-clause 11.2.7) in the last received assignment message indicates measurement information is to be reported on a per carrier basis and the LINK_QUALITY_MEASUREMENT_MODE field (see sub-clause 11.2.7) received in the same assignment message indicates the mobile station shall report the mean BEP on each assigned time slot. When included it only provides information for each timeslot assigned to the carrier on which the MS was polled.</p>
<p><b>I_LEVEL_TN0</b> (4 bit field)  <b>I_LEVEL_TN1</b> (4 bit field)  <b>I_LEVEL_TN2</b> (4 bit field)  <b>I_LEVEL_TN3</b> (4 bit field)  <b>I_LEVEL_TN4</b> (4 bit field)  <b>I_LEVEL_TN5</b> (4 bit field)  <b>I_LEVEL_TN6</b> (4 bit field)  <b>I_LEVEL_TN7</b> (4 bit field)</p> <p>These fields contain the <math>\gamma</math> value calculated on timeslots 0 through 7, respectively. The <math>\gamma</math> value is defined in 3GPP TS 45.008. These fields are encoded relative to the applicable C_VALUE (see C_VALUE field description above) as defined for the mapping defined in 3GPP TS 45.008 [15] for interference level (I_LEVEL):</p> <pre> bit 4 3 2 1 0 0 0 0  I_LEVEL 0 0 0 0 1  I_LEVEL 1 ... 1 1 1 0  I_LEVEL 14 1 1 1 1  I_LEVEL 15 </pre>

**GMSK\_MEAN\_BEP** (5 bit field)  
**8PSK\_MEAN\_BEP** (5 bit field)  
**16QAM\_NSR\_MEAN\_BEP** (5 bit field)  
**32QAM\_NSR\_MEAN\_BEP** (5 bit field)

These fields contain the mean value of the Bit Error Probability of the channel averaged over all timeslots in the UFPS for the relevant modulation scheme, refer to 3GPP TS 45.008 [15].

**GMSK\_CV\_BEP** (3 bit field)  
**8PSK\_CV\_BEP** (3 bit field)  
**16QAM\_NSR\_CV\_BEP** (3 bit field)  
**32QAM\_NSR\_CV\_BEP** (3 bit field)

These fields contain the variation coefficient for the Bit Error Probability averaged over all timeslots of the UFPS for the relevant modulation scheme, refer to 3GPP TS 45.008 [15].

**REPORTED\_MODULATION** (2 bit field)

The mobile station shall report the modulation scheme (indicated using the REPORTED\_MODULATION field) with which it has received the largest number of blocks since the last report and shall report the MEAN\_BEP\_TN<sub>x</sub> of that modulation scheme (see 3GPP TS 45.008). The mapping of the modulation scheme is as follows.

bit	
2 1	
0 0	GMSK
0 1	8PSK
1 0	16QAM
1 1	32QAM

**MEAN\_BEP\_TN0** (4 bit field)  
**MEAN\_BEP\_TN1** (4 bit field)  
**MEAN\_BEP\_TN2** (4 bit field)  
**MEAN\_BEP\_TN3** (4 bit field)  
**MEAN\_BEP\_TN4** (4 bit field)  
**MEAN\_BEP\_TN5** (4 bit field)  
**MEAN\_BEP\_TN6** (4 bit field)  
**MEAN\_BEP\_TN7** (4 bit field)

These fields contain the mean bit error probability value calculated on timeslots 0 through 7 for the modulation scheme indicated using the REPORTED\_MODULATION field. For the calculation of the mean bit error probability, refer to 3GPP TS 45.008. These fields are transferred only when the mobile station is in packet transfer mode. In RTTI configuration, the mean bit error probability value calculated on per timeslot pair shall be reported on **MODULATION\_1\_MEAN\_BEP\_TN<sub>x</sub>/MODULATION\_2\_MEAN\_BEP\_TN<sub>x</sub>** where TN<sub>x</sub> is the lower numbered timeslot of each reported timeslot pair.

## 12.67 DOWNLINK\_eTFI\_ASSIGNMENT

This information element is only used for a DL MC configuration and identifies the extended TFI (eTFI) that along with the TFI is unique to the PDCHs resources assigned to a MS on a given downlink carrier of a downlink Temporary Block Flow (TBF). The eTFI and TFI values assigned for a given downlink carrier may be different from those assigned for any other carrier on which it has been assigned PDCH resources for its downlink TBF.

**Table 12.67.1: DOWNLINK\_eTFI\_ASSIGNMENT information element details**

**DOWNLINK\_eTFI\_ASSIGNMENT** (3 bit field)  
This field is encoded as a binary number.  
Range 0 to 7

---

## 13 Timers and counters

The tables in sub-clause 13.1 and 13.2 specify the timers used in RLC/MAC protocol signalling. The denotation of columns is defined as follows:

timer ::=	name of the timer;
started ::=	under which conditions the timer is started;
stopped ::=	under which conditions the timer is stopped;
action at expiry ::=	which actions the GPRS entity shall perform at expiry;
value ::=	the duration between setting the timer and expiry of the timer ("s" denotes "second(s)" "xx - yy" means that any value between xx and yy is permitted).

## 13.1 Timers on the Mobile Station side

For each timer, it is shown whether one timer instance is needed per MS, per TBF/MBMS radio bearer, per MS\_ID or per RLC/MAC control message.

Table 13.1.1: Specification of timers used in GPRS on the Mobile Station side

timer	started	stopped	action at expiry	value
T3158 (per MS)	Started when ordered by a NETWORK_CONTROL_ORDER and then restarted each time a Network Controlled (NC) Measurement is performed in MM Ready state and in packet idle or packet transfer mode in <i>A/Gb mode</i> and in RRC-Cell_Shared state and MAC-Idle or MAC-Shared state in <i>lu mode</i> .	See 3GPP TS 45.008	Restart the timer, perform the measurement and send a NC Measurement report. The timer shall be restarted with either of the parameters NC_REPORTING_PERIOD_I when in packet idle mode or MAC-Idle state or with the parameter NC_REPORTING_PERIOD_T when in packet transfer mode or MAC-Shared state	Defined by the parameter or by a random value (see 3GPP TS 45.008)
T3162 (per MS)	On receipt of a PACKET QUEUING NOTIFICATION	On receipt of a PACKET UPLINK ASSIGNMENT	Abort packet access procedure; indicate packet access failure to upper layers and return to packet idle mode or MAC-Idle state listening to its paging subchannel	5 s
T3164 (per TBF)	On receipt of a PACKET UPLINK ASSIGNMENT or MULTIPLE TBF UPLINK ASSIGNMENT message. A separate instance of T3164 is started for each TBF for which resources were assigned.	At sending of the first RLC/MAC block	See sub-clause 7.1.4. ( <i>A/Gb mode</i> ) or 3GPP TS 44.160 sub-clause 7.2.5 ( <i>lu mode</i> ).	5 s
T3166 (per MS)	At sending of the first RLC/MAC block at one phase access	On receipt of a PACKET UPLINK ACK/NACK	Immediately stop transmitting on the assigned TBF; a TBF establishment failure has occurred or the contention resolution procedures has failed	5 s
T3168 (per TBF)	At sending the PACKET RESOURCE REQUEST message, (Extended) Channel Request Description IE in PACKET DOWNLINK ACK/NACK or the PACKET CONTROL ACKNOWLEDGEMENT message requesting new TBF. A separate instance of T3168 is started for each TBF for which resources were requested.	On receipt of a PACKET UPLINK ASSIGNMENT, MULTIPLE TBF UPLINK ASSIGNMENT, PACKET TIMESLOT RECONFIGURE or a MULTIPLE TBF TIMESLOT RECONFIGURE message that assigns resources to an uplink TBF for which T3168 is running. On receipt of a PACKET ACCESS REJECT message that rejects one or more uplink TBFs for which T3168 is running.	Reinitiate the packet access procedure or retransmit the PACKET RESOURCE REQUEST or PACKET DOWNLINK ACK/NACK for the TBFs that have not been assigned resources.	Set to 2 times the value of T3168 sent as part of system broadcast information if the total number of TBFs requested is greater than 1. Otherwise, it shall be set to the value of T3168 sent as part of system broadcast information.

timer	started	stopped	action at expiry	value
T3170 (per MS)	After having made M + 1 attempts to send a PACKET CHANNEL REQUEST or EGPRS PACKET CHANNEL REQUEST or MPRACH PACKET CHANNEL REQUEST message (if at least one message was transmitted by the mobile station), or on receipt of a PACKET ACCESS REJECT message.	On receipt of a PACKET UPLINK ASSIGNMENT or PACKET DOWNLINK ASSIGNMENT or PACKET QUEUING NOTIFICATION message.	Abort packet access procedure. In case of the expiry after having made M+1 attempts to send a PACKET CHANNEL REQUEST or EGPRS PACKET CHANNEL REQUEST or MPRACH PACKET CHANNEL REQUEST message, indicate a random access failure to upper layers and perform autonomous cell re-selection. In case of the expiry following the receipt of a PACKET ACCESS REJECT message, indicate a packet access failure to upper layers and return to packet idle mode or MAC-Idle state.	Defined by parameters TX_INT and S
T3172 (per TBF)	On receipt of a PACKET ACCESS REJECT message an instance of T3172 is started for each of the TBFs that have been rejected.	On receipt of a PACKET UPLINK ASSIGNMENT message or MULTIPLE TBF UPLINK ASSIGNMENT that assigns resources to the TBF for which T3172 is running.	Packet Access in the cell no longer prohibited	assigned in message
T3174 (per MS)	On receipt of a PACKET CELL CHANGE ORDER message	On the successful completion or the occurrence of an abnormal condition in the network controlled cell reselection procedure	Return to old cell, perform cell update (or other GMM specific procedure) and send PACKET CELL CHANGE FAILURE	15 s
T3176 (per MS)	Expiry of T3174 or other abnormal condition in the network controlled cell reselection procedure	After sending of PACKET CELL CHANGE FAILURE message	Stop handling of abnormal condition in the network controlled cell reselection procedure.	15 s
T3180 (per TBF)	When transmitting an RLC/MAC block to the network an instance of T3180 is started for the TBF for which the block was intended. It is also started for each uplink TBF allocated by the PS HANDOVER COMMAND message/DTM HANDOVER COMMAND message upon successful completion of the PS handover/DTM handover from <i>lu mode</i> to <i>A/Gb mode</i> .	When detecting an assigned USF value on assigned PDCH	Abnormal release with access retry may be performed under certain conditions (see sub-clause 8.1.1.1)	5 s
T3182 (per TBF)	After sending the last data block (with CV = 0), or upon detecting a transmit window stall condition an instance of T3182 is started for the TBF for which the condition has occurred.	On receipt of the PACKET UPLINK ACK/NACK message	Abnormal release with access retry may be performed under certain conditions (see sub-clauses 9.3.2.3 and 9.3.3.3)	5 s
T3184 (per TBF)	On receipt of a PACKET UPLINK ACK/NACK message (in exclusive allocation)	On receipt of PACKET UPLINK ACK/NACK message (T3184 is also restarted)	Abnormal release with access retry may be performed under certain conditions (see sub-clause 8.1.1.3a.2).	5 s

timer	started	stopped	action at expiry	value
T3186 (per MS)	When packet access procedure is started	Either stopped when receiving any message from the network in response to the (EGPRS) PACKET CHANNEL REQUEST message or after M+1 attempts to send (EGPRS) PACKET CHANNEL REQUEST messages on the PRACH channel or stopped when receiving any message from the network in response to the MPRACH PACKET CHANNEL REQUEST message or after M+1 attempts to send MPRACH PACKET CHANNEL REQUEST messages on the uplink PDCH channel	Abort packet access procedure. If at least one message was transmitted by the mobile station, indicate random access failure to upper layers and perform autonomous cell re-selection; otherwise, indicate packet access failure to upper layers and return to packet idle mode or MAC-Idle state.	5 s
T3188	When a mobile station that supports multiple TBF procedures requests two or more uplink TBFs in a Packet Resource Request message during a two-phase access.	When a mobile station that supports multiple TBF procedures receives a MULTIPLE TBF UPLINK ASSIGNMENT message.	A mobile station that supports multiple TBF procedures considers its" two-phase access to have failed	Set to the value of T3168 included as part of system broadcast information.
T3190 (per TBF/ MBMS radio bearer)	At reception of a downlink assignment message an instance of T3190 is started for each TBF/MBMS radio bearer that has been assigned resources. It is also started for each downlink TBF allocated by the PS HANDOVER COMMAND message/DTM HANDOVER COMMAND message upon successful completion of the PS handover/DTM handover from <i>lu mode</i> to <i>A/Gb mode</i> .	Restarted on receipt of data on the TBF/MBMS radio bearer	Abnormal release without retry may be performed under certain conditions (see sub-clauses 8.1.2.1 and 8.1.2.4). The MBMS packet access procedure may be initiated as specified in sub-clause 7.7.1.	5 s
T3192 (per TBF/ per RLC (NOTE 1))	At sending the PACKET DOWNLINK ACK/NACK with the Final Ack Indicator=1, or at sending the PACKET CONTROL ACK as a response to final RLC data block in unacknowledged mode.	Restarted at sending the PACKET DOWNLINK ACK/NACK with the Final Ack Indicator=1, or at sending the PACKET CONTROL ACK as a response to final RLC data block in unacknowledged mode.  Stopped at the reception of a PACKET DOWNLINK ASSIGNMENT, MULTIPLE TBF DOWNLINK ASSIGNMENT, PACKET TIMESLOT RECONFIGURE, MULTIPLE TBF TIMESLOT RECONFIGURE or PACKET CS RELEASE INDICATION message that assigns resources to the TBF for which T3192 was started..	If the mobile station is in packet transfer mode or MAC-Shared state it shall release the resources, stop monitoring the PDCHs, and begin to monitor the paging channel if there are no other ongoing TBFs. The mobile station in dual transfer mode respectively MAC-DTM state shall return to dedicated mode or MAC-Dedicated state. (see sub-clauses 9.3.2.6 and 9.3.3.5).	assigned in system information
T3194 (per TBF)	At the sending of a RLC data block on a radio block that has been stolen (i.e. intended for a different radio bearer). See 3GPP TS 44.160	On receipt of the USF for the radio bearer for which the radio block was stolen.	Restart the timer unless it has expired four times, in which case a link failure is reported to the RRC layer.	200 ms
T3196	When the RR connection request is received from the upper layer.	Upon receipt of the PACKET CS COMMAND message.	Release of all ongoing TBFs and start RR connection establishment as specified in 3GPP TS 44.018.	1.5 s



timer	started	stopped	action at expiry	value
T3200 (per RLC/MAC control message)	On receipt of an RLC/MAC control block containing a segment of an RLC/MAC control message	On receipt of an RLC/MAC control block containing a segment of an RLC/MAC control message such that the mobile station now has the complete control message	Discard and ignore all segments of the partially received RLC/MAC control message	see sub-clause 9.1.11b
T3204 (per MS)	The first attempt to send a PACKET CHANNEL REQUEST during a packet access procedure. The PACKET CHANNEL REQUEST was attempted indicating 'Single block without TBF establishment' and the purpose of the packet access procedure is to send a PACKET PAUSE message.	Upon receipt of a PACKET UPLINK ASSIGNMENT.	The packet pause procedure (sub-clause 7.6) is aborted (A/Gb mode only).	1 s
T3206 (per MS)	When entering CCN mode	When the PACKET CELL CHANGE NOTIFICATION message is transmitted or when CCN is no longer enabled.	Leave CCN mode and continue according to current NC mode	400 ms
T3208 (per MS)	When the PACKET CELL CHANGE NOTIFICATION message is transmitted for the first time	Upon receipt of a PACKET CELL CHANGE CONTINUE or a PACKET CELL CHANGE ORDER message or when CCN is no longer enabled..	Leave CCN mode and continue according to current NC mode	0,96 s
T3210 (per MS)	When the PACKET CELL CHANGE NOTIFICATION message is transmitted for the first time	Upon receipt of a PACKET NEIGHBOUR CELL DATA message, or a PACKET CELL CHANGE CONTINUE message or a PACKET CELL CHANGE ORDER message or when CCN is no longer enabled.	Retransmit the PACKET CELL CHANGE NOTIFICATION message at the first uplink opportunity.	0,3 s
T3214	When the MBMS SERVICE REQUEST message is transmitted or when receiving MBMS notification, for an MBMS session the mobile station is required to receive, with no MBMS p-t-m channel description and indicating that no counting shall be performed.	Upon receipt of the MBMS ASSIGNMENT message addressing the same session that started this timer or any other procedure on (P)CCCH not related to MBMS is triggered or a notification is received for a higher priority session.	Mobile station in packet idle mode or MAC-Idle state: Return to DRX mode.  Mobile station in broadcast/multicast receive mode: Remain in broadcast/multicast receive mode	60 s
T3216 (per MS)	Upon transmission of the PS HANDOVER ACCESS message (see sub-clause 8.10.4.4.4).	Upon receipt of the PACKET PHYSICAL INFORMATION message	The MS returns to the old cell and attempts to resume packet data transmission (see sub-clause 8.10.5).	1 s
T3218 (per MS)	On receipt of PS HANDOVER COMMAND message or Handover from UTRAN Command message or <i>MobilityFromEUTRACommand</i> message.	Upon detecting of the first USF for any uplink TBF assigned to the MS in the new cell.	The MS returns to the old cell and attempts to resume packet data transmission (see sub-clause 8.10.5).	1 s
T3220	When the PACKET PAGING REQUEST message containing MBMS pre-notification parameters, for an MBMS session the mobile station is required to receive, is received.	Upon receipt of the PACKET PAGING REQUEST message containing MBMS notification parameters of the same session that started this timer or any other procedure on PCCCH not related to MBMS is triggered or a notification is received for a higher priority session.	Mobile station in packet idle mode or MAC-Idle state: Return to DRX mode.  Mobile station in broadcast/multicast receive mode: Remain in broadcast/multicast receive mode	46 s

timer	started	stopped	action at expiry	value
T3222	When the PACKET MBMS ANNOUNCEMENT message is received indicating an MBMS broadcast service or an MBMS multicast service to which the mobile station has subscribed and an MBMS session the mobile station has not received, and including the Restriction Timer or the Estimated Session Duration.	When the mobile station enters packet idle mode, if the PACKET MBMS ANNOUNCEMENT message included the Estimated Session Duration.  When the mobile station enters packet idle mode and completes the Transfer non-DRX mode period, if the PACKET MBMS ANNOUNCEMENT message included the Restriction Timer.	The MBMS related information stored upon receipt of the corresponding PACKET MBMS ANNOUNCEMENT message is deleted.	See sub-clause 6.3.2.2
T3290 (per MS_ID on an MBMS radio bearer)	At reception of a downlink assignment (i.e. MBMS ASSIGNMENT, MBMS MS_ID ASSIGNMENT) message assigning an MS_ID to a mobile station receiving an MBMS radio bearer.	Restarted on receipt of an RLC/MAC block including the corresponding MBMS Bearer Identity and the MS_ID in the TFI field.	The mobile station considers the MS_ID as released, i.e. it no longer answers when polled with the MS_ID.	5 s
T3230 (per MS)	When the PACKET CELL CHANGE ORDER or PACKET MEASUREMENT ORDER message containing individual priorities, is received.	Upon occurrence of one of the conditions specified in subclause 5.5.1.1c.3.	The MS shall delete the individual priorities value.	Assigned in message
T3232 (per MS)	At reception of a PACKET PAGING REQUEST message on the PPCH carrying a segment of an ETWS Primary Notification message.	At reception of the complete ETWS Primary Notification message or upon initiating cell reselection or connection establishment procedures.	The mobile station shall enter DRX mode.	5 s

NOTE 1: Timer per RLC entity if EMST is used.

**T3158:** Wait for sending measurement reports for network controlled cell reselection.

This timer is used on the mobile station side to define the period for performing NC-measurements and send measurement reports in either packet idle or packet transfer mode in *A/Gb mode* and MAC-Idle or MAC-Shared state in *Iu mode* (see 3GPP TS 45.008).

**T3162:** Wait for Packet Uplink Assignment after reception of Packet Queuing Notification

This timer is used on the mobile station side after received Packet Queuing Notification to define when to stop waiting for a Packet Uplink Assignment.

**T3164:** Wait for Uplink State Flag After Assignment

This timer is used on the mobile station side to define when to stop waiting for the USF determining the assigned portion of the uplink channel and repeat the procedure for random access. In multislot operation, it is enough that the assigned USF is noted on one of the uplink PDCHs.

**T3166:** Wait for Packet Uplink ACK/NACK after sending of first data block

This timer is used on the mobile station side to define when to stop waiting for a Packet Uplink ACK/NACK after sending of the first data block.

- T3168:** Wait for PACKET UPLINK ASSIGNMENT, MULTIPLE TBF UPLINK ASSIGNMENT, PACKET TIMESLOT RECONFIGURE or a MULTIPLE TBF TIMESLOT RECONFIGURE message
- This timer is used on the mobile station side to define when to stop waiting for a PACKET UPLINK ASSIGNMENT, MULTIPLE TBF UPLINK ASSIGNMENT, PACKET TIMESLOT RECONFIGURE or a MULTIPLE TBF TIMESLOT RECONFIGURE message after sending of a PACKET RESOURCE REQUEST message or a PACKET CONTROL ACKNOWLEDGEMENT message requesting new TBF.
- T3170:** Wait for PACKET UPLINK ASSIGNMENT message after having done (M+1) Packet Channel Requests or after reception of a PACKET ACCESS REJECT message.
- This timer is used on the mobile station side when having made M + 1 attempts to send a PACKET CHANNEL REQUEST or EGPRS PACKET CHANNEL REQUEST or MPRACH PACKET CHANNEL REQUEST message (if at least one message was transmitted by the mobile station) or after reception of a PACKET ACCESS REJECT message. At expiry of timer T3170 when having made M+1 attempts to send a PACKET CHANNEL REQUEST or EGPRS PACKET CHANNEL REQUEST or MPRACH PACKET CHANNEL REQUEST message, the mobile station shall abort the packet access procedure, indicate a random access failure to upper layers and perform autonomous cell re-selection according to 3GPP TS 43.022. At expiry of timer T3170 after receiving a PACKET ACCESS REJECT message, the mobile station shall abort the packet access procedure, indicate a packet access failure to upper layers and return to packet idle mode or MAC-Idle state.
- The value of this timer is equal to the time taken by T+2S TDMA frames, T and S are defined in sub-clause 7.1.2.1.1.
- T3172:** Prohibit packet access in the cell after PACKET ACCESS REJECT message has been received.
- This timer is used on the mobile station side on receipt of a PACKET ACCESS REJECT message corresponding to one of the mobile station's 3 last PACKET CHANNEL REQUEST messages. If T3172 expires before receiving an assignment message, the mobile station returns to packet idle mode or MAC-Idle state.
- After T3172 expiry packet Access is no longer prohibited in the cell but no Channel Request message shall be sent as a response to a page until a PAGING REQUEST message for the mobile station is received.
- T3174:** Wait for successful packet access in new cell after Packet Cell Change Order.
- This timer is used on the mobile station side on receipt of a PACKET CELL CHANGE ORDER message. The timer is stopped upon successful completion of packet access in the new cell. On expiry, the mobile station returns to the old cell, performs cell update (or other GMM specific procedure) and sends PACKET CELL CHANGE FAILURE message.
- T3176:** Stop handling of abnormal condition in the network controlled cell reselection procedure.
- This timer is started when T3174 expires or another abnormal condition occurs in the network controlled cell reselection procedure. The timer is stopped upon transmission of the PACKET CELL CHANGE FAILURE message. On expiry, the mobile station stops handling of abnormal condition in the network controlled cell reselection procedure.
- T3180:** Wait for Uplink State Flag After Data Block
- This timer is used on the mobile station side to define when to stop waiting for the USF determining the assigned portion of the uplink channel after the previous RLC/MAC block is sent. In multislot operation, it is enough that the assigned USF is noted on one of the uplink PDCHs. If expired, the mobile

station repeats the procedure for random access if there are no remaining TBFs. If it expires and there are one or more remaining TBFs the MS may reattempt the establishment of the corresponding uplink TBF.

**T3182:** Wait for Acknowledgement

This timer is used on the mobile station side to define when to stop waiting for temporary Packet Uplink Ack/Nack after the last RLC data block has been sent for the current send window or for the entire Temporary Block Flow.

**T3184:** No Ack/Nack Received

At exclusive allocation, this timer is used to detect a radio link failure condition. If expired, the mobile station performs an abnormal release with access retry.

**T3186:** Supervision of the random access procedure

This timer is used on the mobile station side to define the maximum allowed time to repeat the sending of all PACKET CHANNEL REQUEST or EGPRS PACKET CHANNEL REQUEST or MPRACH PACKET CHANNEL REQUEST messages. At expiry of timer T3186, the mobile station shall abort the packet access procedure. If at least one message was transmitted by the mobile station, it shall indicate a random access failure to upper layers and perform autonomous cell re-selection according to 3GPP TS 43.022; otherwise, it shall indicate a packet access failure to upper layers and return to packet idle mode or MAC-Idle state.

**T3188:** This timer is used by a mobile station that supports multiple TBF procedures to define when to stop waiting for a MULTIPLE TBF UPLINK ASSIGNMENT message after sending a PACKET RESOURCE REQUEST message during a two-phase access that requests two or more uplink TBFs.

**T3190:** Wait for Valid Downlink Data Received from the Network

This timer is used on the mobile station side to stop waiting for the valid data from the network side either following the initial Packet Downlink Assignment/MBMS Assignment or after some previous downlink RLC data block.

**T3192:** Wait for release of the TBF after reception of the final block

This timer is used on the mobile station side when the mobile station has received all of the RLC data blocks. When timer T3192 expires the mobile station shall release the resources associated with the TBF (e.g. TFI) and begin to monitor its paging channel.

**T3194:** Minimum time between stolen radio blocks for a given radio bearer.

Following stealing a radio block for a given radio bearer, the mobile station shall expect to have this radio bearer scheduled via its USF within an interval defined by four times the duration of T3194, else link failure is reported to RRC.

**T3196** Wait for PACKET CS COMMAND message.

This timer is used on the mobile station side to define when to stop waiting for the Packet CS COMMAND message. At expiry of timer T3196, the mobile station shall release all ongoing TBFs and start RR connection establishment as specified in 3GPP TS 44.018.

**T3200** RLC/MAC control message reassembly guard

T3200 is used by the mobile station to control when it will discard segments of a partially received RLC/MAC control message. The mobile station shall have one instance of timer T3200 for each segmented RLC/MAC control message that the mobile station is capable of receiving in parallel.

**T3204:** Wait for Packet Uplink Assignment after the first attempt to send a Packet Channel Request during a packet access procedure. The Packet Channel Request was attempted indicating 'Single block without TBF establishment' and the purpose of the packet access procedure is to send a PACKET PAUSE message.

This timer is used by a mobile station with non-GSM capabilities to stop waiting for a PACKET UPLINK ASSIGNMENT message. At expiry of timer T3204, the Packet Pause procedure (sub-clause 7.6) is aborted.

**T3206** Wait for sending of the PACKET CELL CHANGE NOTIFICATION message after entering CCN mode

This timer is used to control that the MS in CCN mode is not prevented to proceed with a cell re-selection for too long if it cannot send the PACKET CELL CHANGE NOTIFICATION message (e.g. T3192 is running and there is no uplink block granted to the MS).

**T3208** Maximum delay of the MS initiated cell re-selection after the point in time when the MS has sent the PACKET CELL CHANGE NOTIFICATION message in CCN mode.

T3208 is used by the mobile station in CCN mode to decide when to stop waiting for network assistance for the cell reselection (see sub-clause 5.5.1.1a).

**T3210** Wait for retransmitting the PACKET CELL CHANGE NOTIFICATION message after having sent the PACKET CELL CHANGE NOTIFICATION message for the first time (see sub-clause 5.5.1.1a).

This timer is used to request the mobile station to retransmit the PACKET CELL CHANGE NOTIFICATION message in the case it has not received any PACKET NEIGHBOUR CELL DATA message nor PACKET CELL CHANGE CONTINUE message nor PACKET CELL CHANGE ORDER message nor the PS HANDOVER COMMAND message in response to the sending of the PACKET CELL CHANGE NOTIFICATION message sent for the first time. It can reduce the cell re-selection delay implied by entering CCN mode in case the first PACKET CELL CHANGE NOTIFICATION message was not received by the network.

**T3214** Wait for MBMS ASSIGNMENT message.

This timer is used on the mobile station side to define when to stop waiting for the MBMS ASSIGNMENT message. At expiry of timer T3214, a mobile station in packet idle mode or MAC-Idle state shall return to DRX mode. A mobile station in broadcast/multicast receive mode shall remain in broadcast/multicast receive mode.

**T3216** Wait for the PACKET PHYSICAL INFORMATION message.

This timer is used on the mobile station side to define when to stop waiting for the PACKET PHYSICAL INFORMATION message in the non-synchronized cell PS handover case (see sub-clause 8.10.4.4.4). At expiry of timer T3216, the mobile station shall abort the PS handover procedure, return to the old cell, send a PACKET CELL CHANGE FAILURE message using the first available uplink transmission opportunity (if PS handover from *A/Gb mode* was attempted) and attempt to continue all TBFs/RABs that were ongoing prior to the reception of the PS HANDOVER COMMAND message/Handover from UTRAN Command message or *MobilityFromEUTRACommand* message (see sub-clause 8.10.5).

- T3218** Wait for the first USF for any uplink TBF assigned to the MS after receiving the PS HANDOVER COMMAND message or Handover from UTRAN Command message or *MobilityFromEUTRACommand* message.
- This timer is used on the mobile station side to define when to stop waiting for a USF of any uplink TBF assigned to the MS in the new cell.
- At expiry of timer T3218, the mobile station shall abort the PS handover procedure, return to the old cell, send a PACKET CELL CHANGE FAILURE message using the first available uplink transmission opportunity (if PS handover from *A/Gb mode* was attempted) and attempt to continue all TBFs or RABs that were ongoing prior to the reception of the PS HANDOVER COMMAND message or Handover from UTRAN Command message or *MobilityFromEUTRACommand* message (see sub-clause 8.10.5).
- T3220** Wait for PACKET PAGING REQUEST message.
- This timer is used to ensure that the mobile station stops waiting for a PACKET PAGING REQUEST message containing an MBMS notification part. At expiry of the T3220, the mobile station in packet idle mode or MAC-Idle state shall return to DRX mode unless it is already engaged in any other MBMS session and remaining in broadcast/multicast receive mode.
- T3222** An instance of the timer may be used during the notification of MBMS for mobile stations in packet transfer mode or in dual transfer mode. An instance of this timer may be started at the receipt of a PACKET MBMS ANNOUNCEMENT message when in packet transfer mode or in dual transfer mode.
- The instance of this timer is stopped either when the mobile station enters packet idle mode, if the PACKET MBMS ANNOUNCEMENT message included the Estimated Session Duration, or when the mobile station enters packet idle mode and completes the Transfer non-DRX mode period, if the PACKET MBMS ANNOUNCEMENT message included the Restriction Timer.
- At expiry of an instance of this timer, the mobile station discards the MBMS related information stored upon receipt of the corresponding PACKET MBMS ANNOUNCEMENT message.
- T3290** Wait for Downlink Data identified with the assigned MS\_ID during an MBMS radio bearer.
- This timer is used on the mobile station side to stop answering to polling during an MBMS radio bearer.
- T3290 has the same value as the one specified for T3190.
- T3230** The timer is used to control the validity period of the individual priorities. It is started on receipt of the individual priorities included in the PACKET CELL CHANGE ORDER or PACKET MEASUREMENT ORDER message for cell reselection or on inter-RAT reselection to GERAN if the corresponding timer in the source RAT (i.e, T320 in E-UTRA, T322 in UTRA) was running when reselection occurred.
- When one of the conditions specified in subclause 5.5.1.1c.3 is met, the MS shall stop T3230 and delete the corresponding individual priorities.
- At expiry the mobile station shall delete the corresponding individual priorities.
- T3232** The timer is used to control the length of the non-DRX mode period in which the mobile station is acquiring an ETWS Primary Notification message. It is started when receiving a PACKET PAGING REQUEST message on the PPCH carrying a segment of an ETWS Primary Notification message.
- It is stopped at reception of the complete ETWS Primary Notification message or upon initiating cell reselection or connection establishment procedures.
- At expiry the mobile station shall enter DRX mode.



T3199 (per MS_ID on an MBMS radio bearer)	If counter N3109 = N3109_MAX an instance of T3199 is started for this MS_ID.  At the point in time denoted by the Current MS_ID Expiry Time while no PACKET CONTROL ACKNOWLEDGEMENT message has been received, an instance of T3199 is started for this MS_ID.	None	The network releases the MS_ID on the corresponding MBMS radio bearer.	5 s
NOTE 1: Timer per RLC entity if EMST is used.				

- T3169:** Wait for Reuse of USF and TFI(s) after the mobile station uplink assignment for this TBF is invalid
- This timer is used on the network side to define when the current uplink assignment for this TBF is surely invalid on the mobile station side so that the assigned USF(s) and TFI can be reused on the uplink. During that period the corresponding USF(s) is not broadcast.
- Its value is network dependent. The value of T3169 should be greater than T3180, T3182 and (for exclusive allocation) T3184.
- T3191:** Wait for reuse of TFI(s) after sending of the last RLC Data Block on this TBF. Wait for reuse of TFI(s) after sending the PACKET TBF RELEASE for an MBMS radio bearer.
- This timer is used on the network side to define when the current assignment for this TBF/MBMS is surely invalid on the mobile station side so that the TFI(s) can be reused.
- Its value is network dependent.
- T3193:** Wait for reuse of TFI(s) after reception of the final PACKET DOWNLINK ACK/NACK from the mobile station for this TBF.
- This timer is used on the network side to define when timer T3192 on the mobile station side has surely expired so that the TFI can be reused.
- Its value is network dependent.
- T3195:** Wait for reuse of TFI(s) when there is no response from the MS (radio failure or cell change) for this TBF/MBMS radio bearer.
- This timer is used on the network side to define when the current assignment for this TBF/MS\_ID on an MBMS radio bearer is surely invalid on the mobile station side so that the TFI can be reused.
- Its value is network dependent.
- T3197:** Wait for the indication from the mobile station that it has received needed system information messages.
- This timer is used on the network side to delay the release of RR connection release in order to maintain radio resources before the mobile station has indicated the receipt of system information messages specified in sub-clause 5.5.1.2 or 5.5.1.3.
- T3199:** Wait for reuse of MS\_ID on an MBMS radio bearer.
- This timer is used on the network side to define for a given MBMS radio bearer when a(n) (re)assigned MS\_ID is surely invalid on the mobile station side so that this MS\_ID can be reused. During that period the corresponding MS\_ID is not used.
- Its value is network dependent.



### 13.3 Counters on the Mobile Station side

- N3102** At each cell reselection the mobile station shall set the counter N3102 to the value defined by the optional broadcast parameter PAN\_MAX. Whenever the mobile station receives a Packet Ack/Nack that allows the advancement of V(S), the mobile station shall increment N3102 by the broadcast value PAN\_INC, however N3102 shall never exceed the value PAN\_MAX. Each time T3182 expires the mobile station shall decrement N3102 by the broadcast value PAN\_DEC. When  $N3102 \leq 0$  is reached, the mobile station shall perform an abnormal release with cell re-selection.
- N3104** When the mobile station sends the first RLC/MAC block the counter N3104 shall be initialized to 1. For each new RLC/MAC block the mobile station sends it shall increment N3104 by 1 until the first correct PACKET UPLINK ACK/NACK message is received. Then N3104 shall not be further incremented. If the N3104 counter is equal to N3104\_MAX and no correct PACKET UPLINK ACK/NACK message has been received, the contention resolution fails and the mobile station behaves as specified in sub-clause 7.1.2.3.
- N3104\_MAX shall have the value:
- $$N3104\_MAX = 3 * (BS\_CV\_MAX + 3) * \text{number of uplink timeslots assigned.}$$
- N3106** N3106 is used in *Iu mode* on the mobile station side to detect link failures that may occur for a given uplink RLC entity and shall be reported to the RRC layer. It is incremented each time a response to a given request is not received before a specified response time. It is reset upon reception of a response within the response time requirements. If the counter N3106 is equal to N3106max, a link failure has occurred that shall be reported to the RRC layer. There is one N3106 instance per uplink RLC entity in TCH or DCCH TBF mode.
- N3106max shall have the value: 5.

### 13.4 Counters on the Network side

- N3101:** When the network after setting USF for a given TBF, receives a valid data block of this TBF from the mobile station in a block assigned for this USF, it will reset counter N3101. If PS Handover is not ongoing, the network will increment counter N3101 for each USF for which no data is received for this TBF. N3101max shall be greater than 8. If  $N3101 = N3101max$ , the network shall stop the scheduling of RLC/MAC blocks from the mobile station for this USF and start timer T3169.
- During extended uplink TBF mode, counter N3101 shall not be incremented if the network does not require a mobile station to send PACKET UPLINK DUMMY CONTROL BLOCK messages when there is no other RLC/MAC block ready to send for this TBF in uplink radio blocks allocated by the network (see sub-clause 9.3.1b.2).
- The use of N3101 during PS Handover is implementation specific.
- N3103:** N3103 is reset when transmitting the final PACKET UPLINK ACK/NACK message within a TBF (final ack indicator set to 1). If the network does not receive the PACKET CONTROL ACKNOWLEDGEMENT message in the scheduled block for this TBF, it shall increment counter N3103 and retransmit the PACKET UPLINK ACK/NACK message. If counter N3103 exceeds its limit, the network shall start timer T3169.
- N3105:** When the network after sending a RRBP field in the downlink RLC data block or in *Iu mode* also RLC/MAC control block, receives a valid RLC/MAC control message from the mobile station, it will reset counter N3105. The network will increment counter N3105 for each allocated data block for which no RLC/MAC control message is received for this TBF. The value of N3105max is network dependent.
- During an MBMS data transfer, whenever the network receives a valid RLC/MAC control message from a mobile station identified by a given MS\_ID value, it shall reset the counter N3105 for that MS\_ID. The network shall increment the counter N3105 for a given MS\_ID for each radio block, allocated via the polling procedure to the mobile station identified by that MS\_ID value, for

which no RLC/MAC control message is received. The value of N3105\_MBMS\_MAX is network dependent

**N3107** N3107 is used in *Iu mode* on the network side to detect link failures that may occur for a given RLC entity and that shall be reported to the RRC layer. It is incremented each time a response to a given request is not received before a specified response time. It is reset upon reception of a response within the response time requirements. If the counter N3107 is equal to N3107max, a link failure has occurred that shall be reported to the RRC layer. There is one N3107 instance per downlink RLC entity in TCH or DCCH TBF mode. The value of N3107max is network dependent.

**N3109:** N3109 for a given MS\_ID on an MBMS radio bearer is reset when transmitting for the first time the MBMS MS\_ID ASSIGNMENT message including a polling request. If the network does not receive the PACKET CONTROL ACKNOWLEDGEMENT message in the scheduled block, it shall increment counter N3109 for that MS\_ID and may retransmit the MBMS MS\_ID ASSIGNMENT message. If counter N3109 = N3109\_MAX, the network shall start timer T3199 for that MS\_ID. The value of N3109\_MAX is network dependent.

---

## Annex A (informative): Bibliography

- 1) ITU-T Recommendation I.130: "Method for the characterization of telecommunication services supported by an ISDN and network capabilities of an ISDN".
- 2) ITU-T Recommendation Q.65: "The unified functional methodology for the characterization of services and network capabilities".
- 3) ISO/IEC 8886: "Information technology - Open Systems Interconnection - Data link service definition".
- 4) ISO/IEC 10022: "Information technology - Open Systems Interconnection - Physical Service Definition".
- 5) ISO/IEC 10039: "Information technology - Open Systems Interconnection - Local area networks - Medium Access Control (MAC) service definition".
- 6) ISO/IEC 4335: "Information technology - Telecommunications and information exchange between systems - High-level data link control (HDLC) procedures - Elements of procedures".
- 7) ISO/IEC 7478: "Information processing systems - Data communication - Multilink procedures".
- 8) ISO/IEC 7498: "Information technology - Open Systems Interconnection - Basic Reference Model".

# Annex B (informative): RLC data block encoding

## B.1 Example 1

Figure B.1 provides an example of the use of the Length indicator in conjunction with the M and E bits. In the example, LLC PDU 1 continues from a previous RLC data block and ends in the RLC data block shown. LLC PDU 2 follows LLC PDU 1 and is completely contained within the RLC data block. LLC PDU 3 follows LLC PDU 2, beginning in the RLC data block shown, and continues into the next RLC data block.

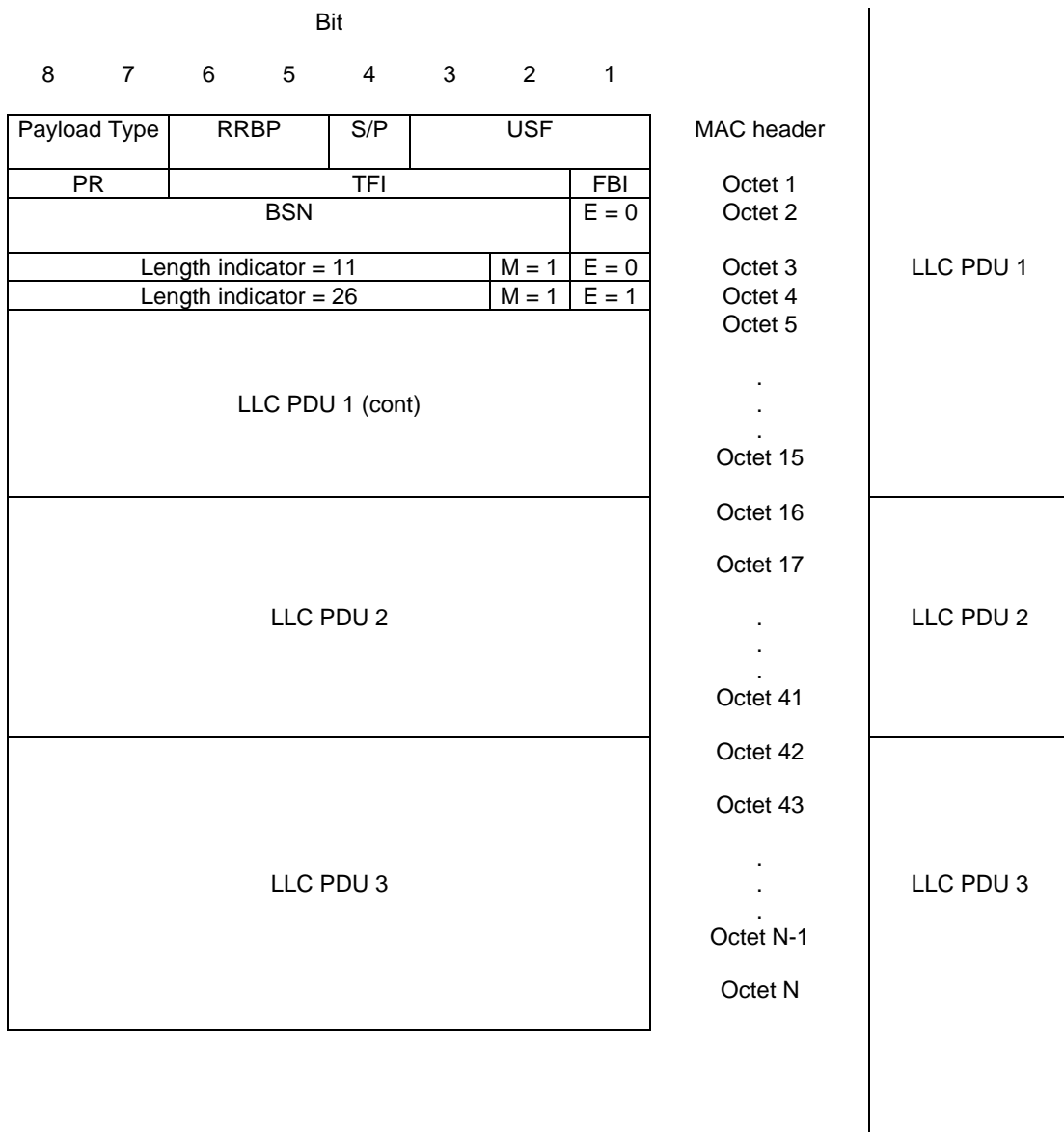

Figure B.1: Length indicator (LI) example

## B.2 Example 2

Figure B.2 provides an example of the use of the Length indicator when the end of an LLC PDU would fit within an RLC data block but the addition of the length indicator octet (to indicate the LLC PDU boundary) causes the LLC PDU to extend into another RLC data block. In the example, LLC PDU 1 continues from a previous RLC data block and has

20 remaining octets. The first 19 octets are placed into RLC data block N, the Length Indicator is set to 0 (to indicate that the LLC PDU does not end within the current RLC data block), and the 20<sup>th</sup> octet is placed in RLC data block N+1.

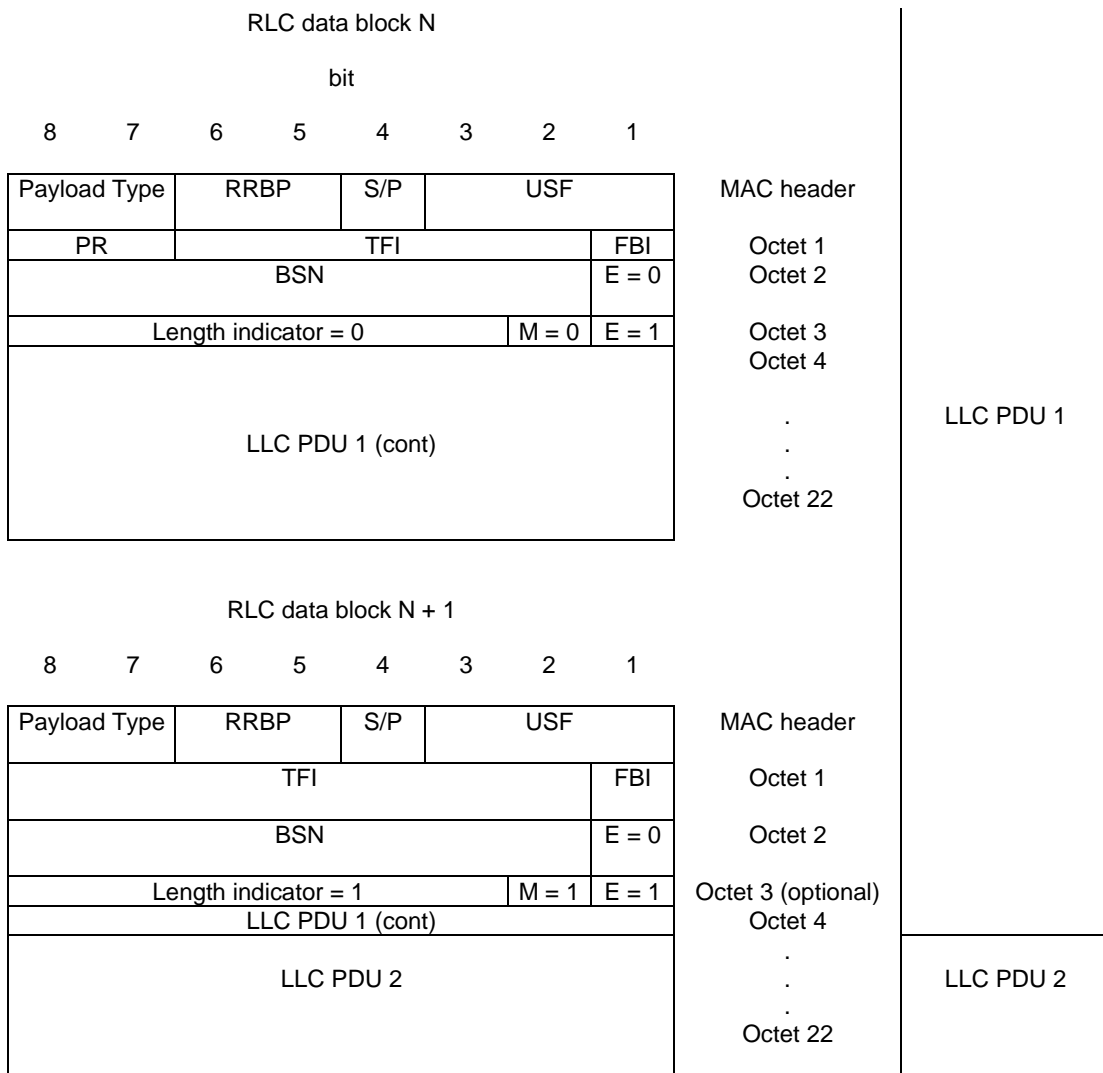
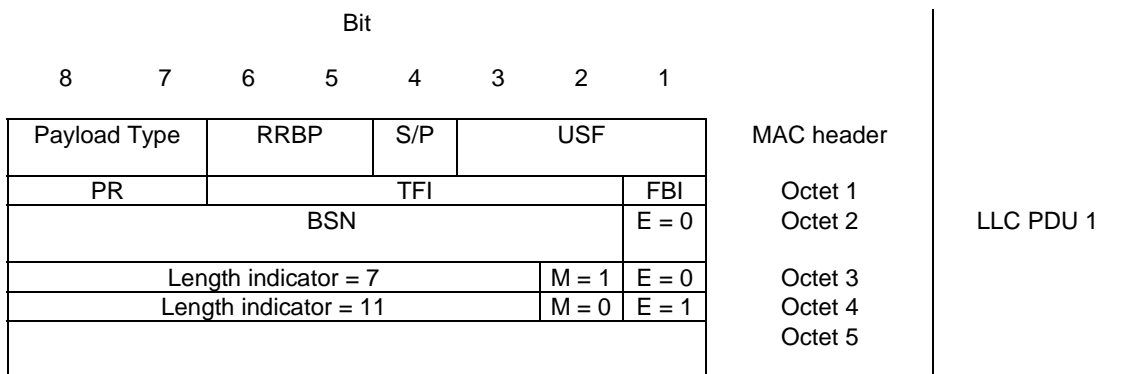

Figure B.2: Length indicator (LI) example

### B.3 Example 3

Figure B.3 provides an example of the use of the Length indicator when the end of an LLC PDU fits precisely into an RLC data block. In the example, LLC PDU 1 continues from a previous RLC data block and ends in the RLC data block shown. LLC PDU 2 follows LLC PDU 1 and fills precisely the RLC data block shown.



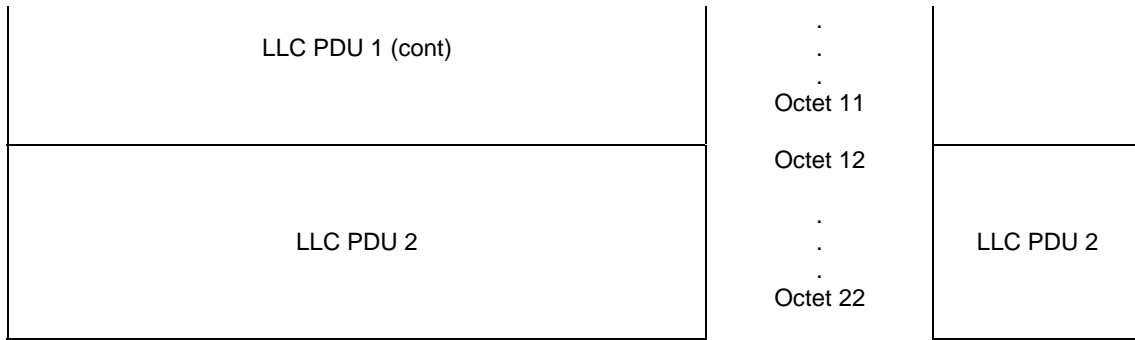
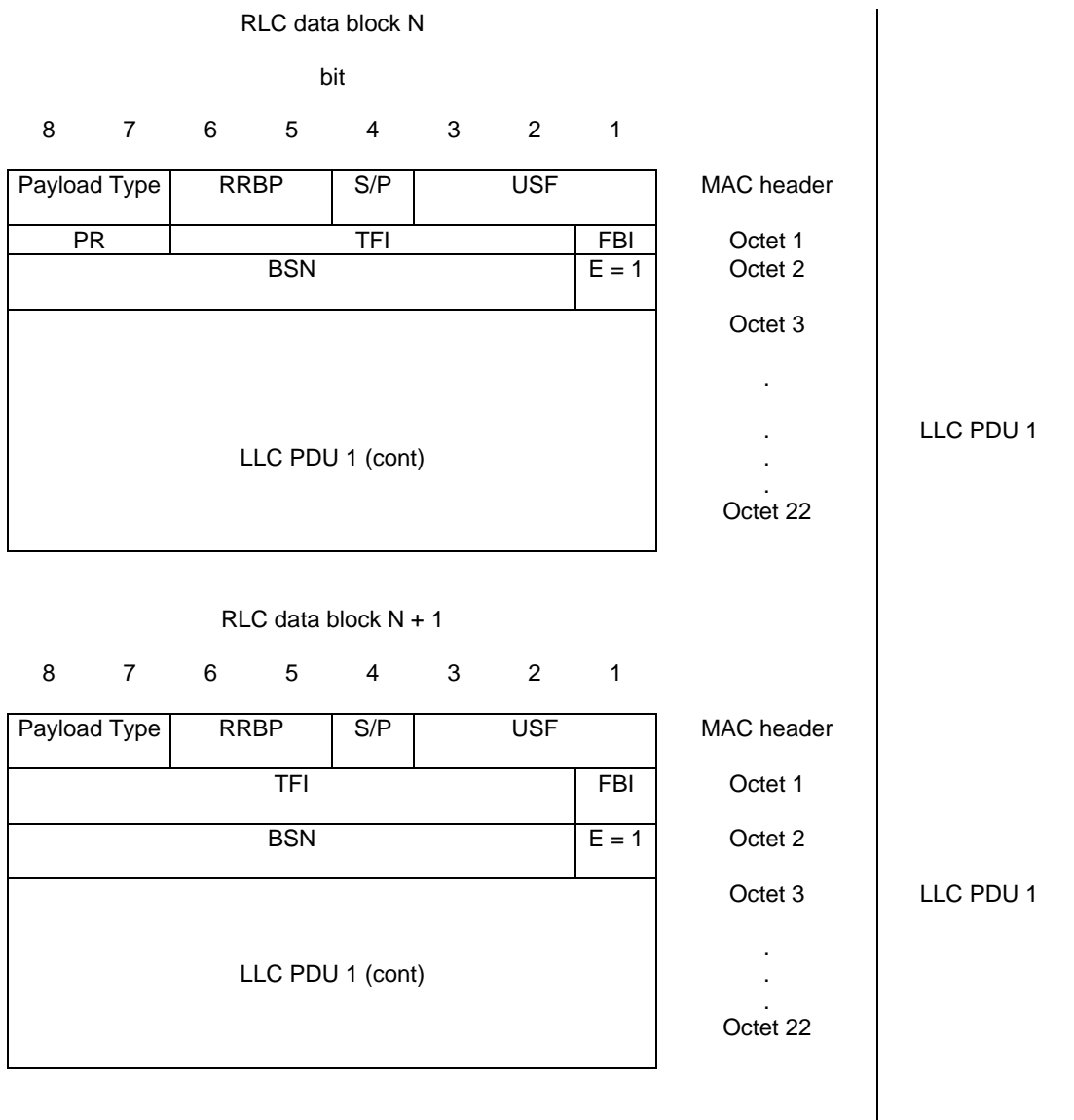

Figure B.3: Length indicator (LI) example

### B.4 Example 4

Figure B.4 provides an example when the Length indicator is not used. As the example does not contain any LLC frame boundaries, no Length Indicator octets are needed. 20 octets is used for LLC data in each RLC data block.



**Figure B.4: Example when Length indicator (LI) can be omitted**

### B.5 Example 5

Figure B.5 provides an example when the final LLC PDU (FBI=1) of a *downlink* TBF fills the RLC data block precisely in which case the Length indicator can be omitted. In the example, LLC PDU 1 continues from a previous RLC data block and ends in and fills precisely the RLC data block shown.

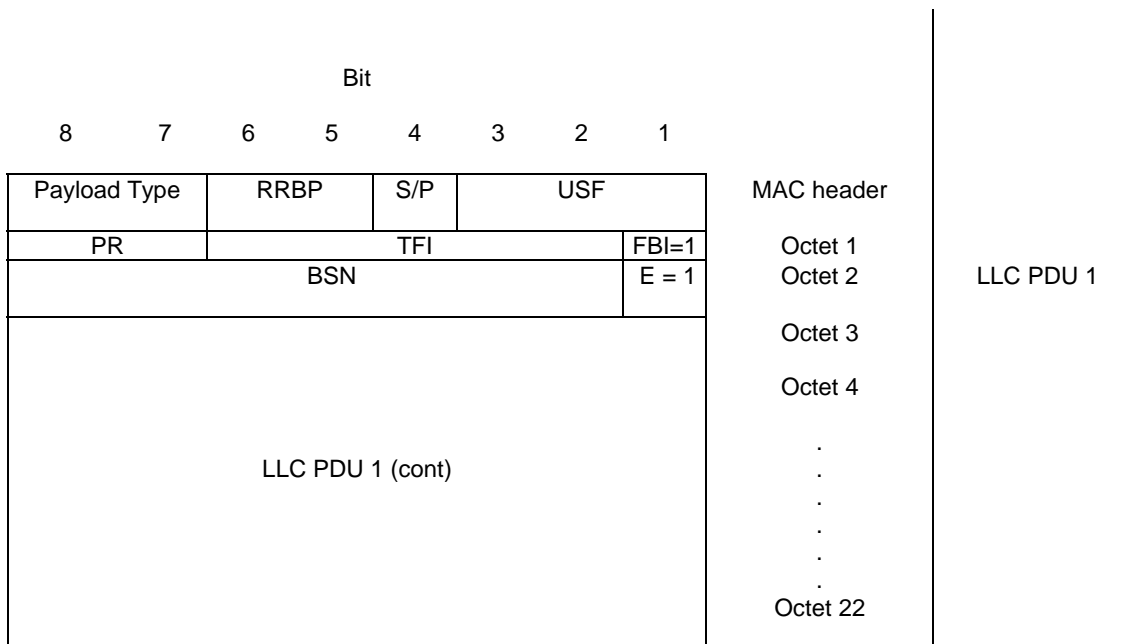

Figure B.5: Example when Length indicator (LI) can be omitted

### B.6 Example 6

Figure B.6 provides an example when the final LLC PDU (CV=0) of an *uplink* TBF fills the RLC data block precisely in which case the Length indicator can be omitted. In the example, LLC PDU 1 continues from a previous RLC data block and ends in and fills precisely the RLC data block shown.

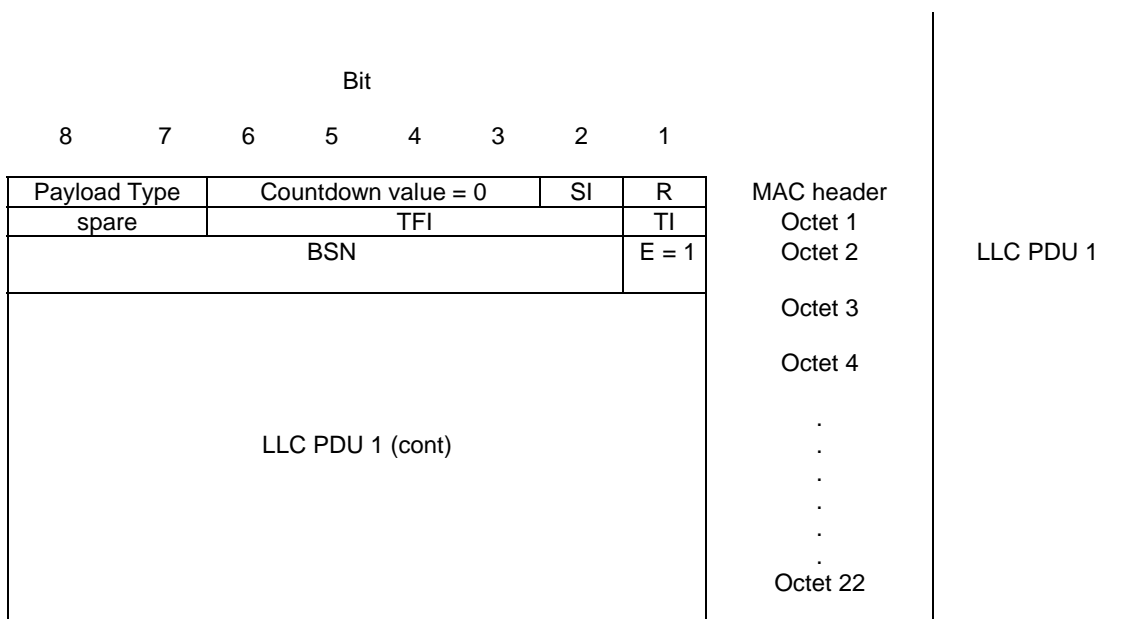



Figure B.6: Example when Length indicator (LI) can be omitted

### B.7 Example 7

Figure B.7 provides an example when the Length indicator can be omitted. As the LLC PDU 1 begins in the RLC data block N and continues to the next one, no Length octet is needed.

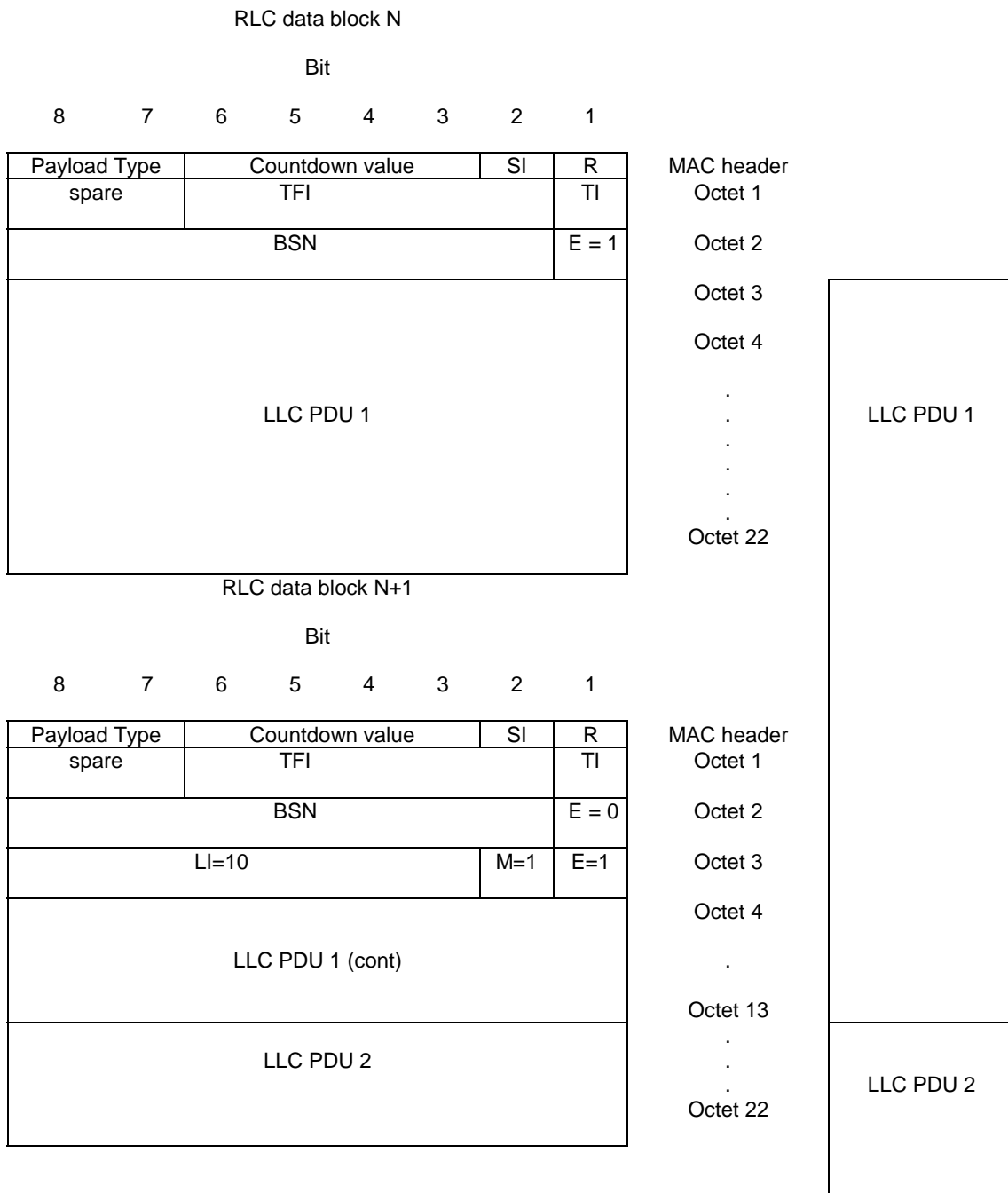
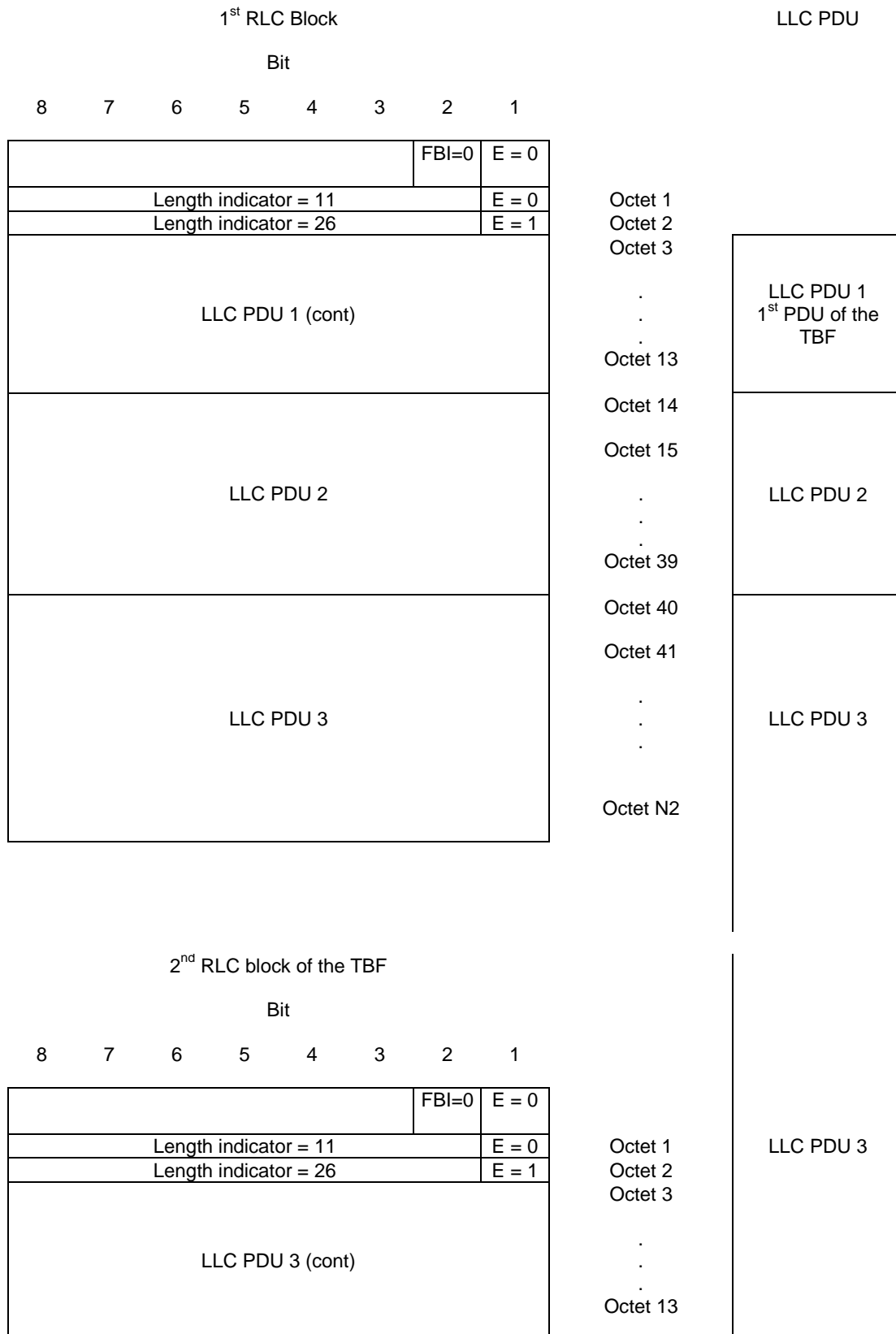

Figure B.7: Example when Length indicator (LI) can be omitted

## B.8 RLC data block delimitation for EGPRS

### B.8.1 Example 1

Figure B.8 shows the first 2 RLC blocks of a TBF (Down-link). Only the last segment of a LLC PDU requires a length indicator.



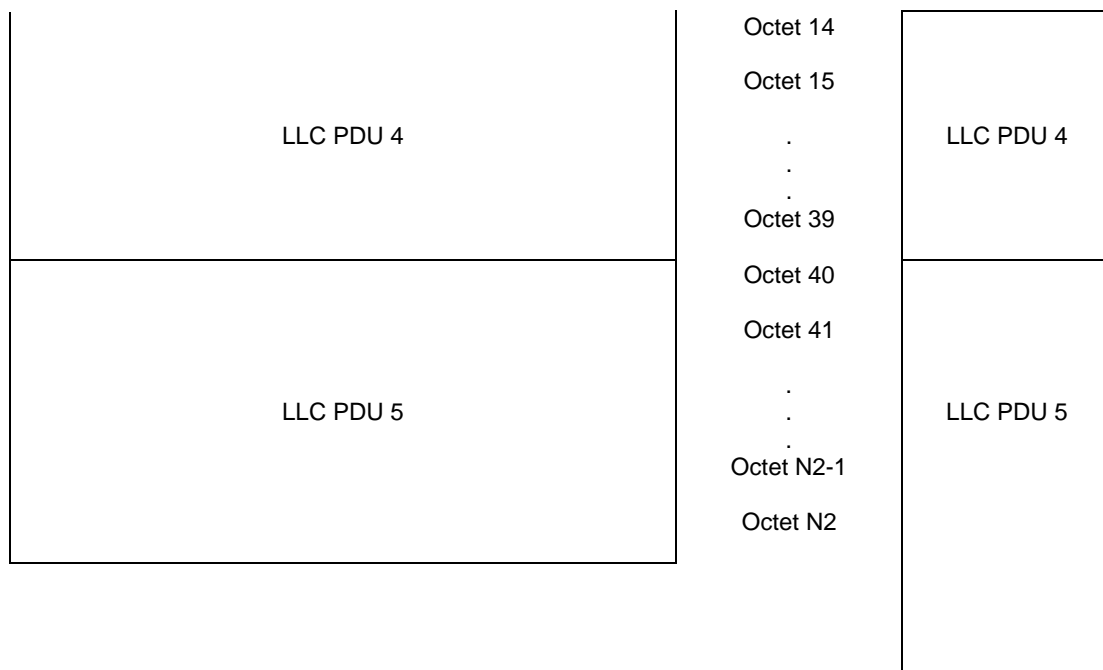
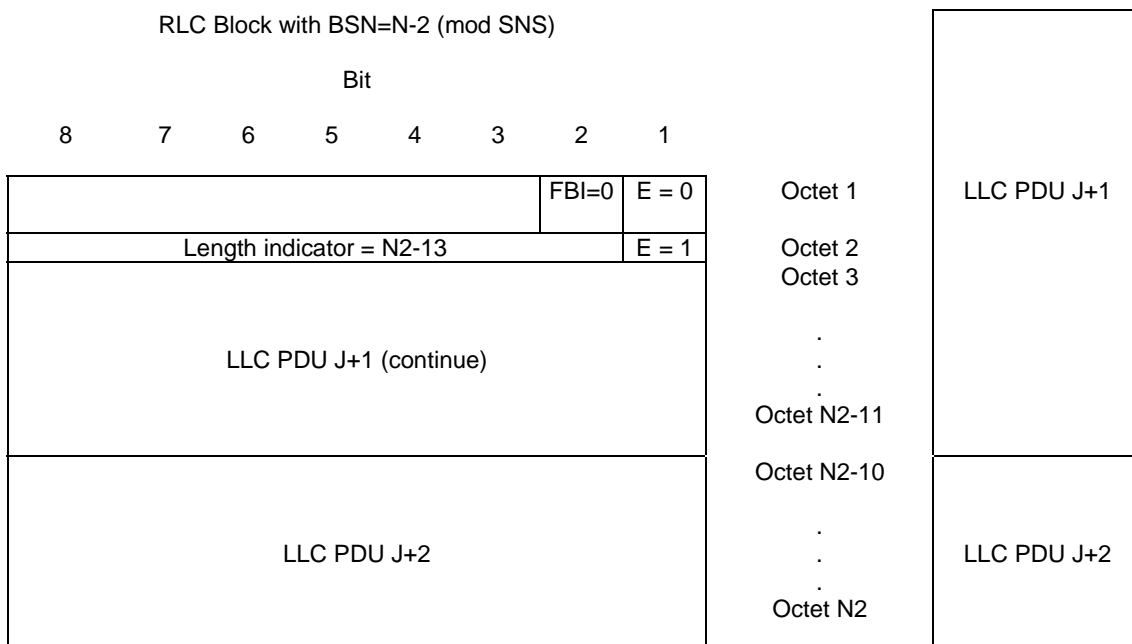

Figure B.8: Example for the case when a LLC PDU stretches over more than 2 consecutive in sequence RLC data blocks (LLC PDU 3 and LLC PDU 5).

### B.8.2 Example 2

Figure B.9 shows the last 3 RLC blocks of a TBF consisting of N blocks (Downlink). When an LLC PDU fills an RLC data block precisely and adding an LI for it would push the LLC PDU into the next in sequence RLC data block, then the LLC PDU is present in this RLC data block without a corresponding length indicator. If this LLC PDU is not the last LLC PDU of the TBF, its delimitation is indicated by the first length indicator of the next in sequence RLC data block with value LI=0. In case when the LLC PDU, or the last segment of it, does not fill the RLC data block, a length indicator with value 127 is added as the last length indicator of the RLC data block.



RLC Block with BSN=N-1 (mod SNS)

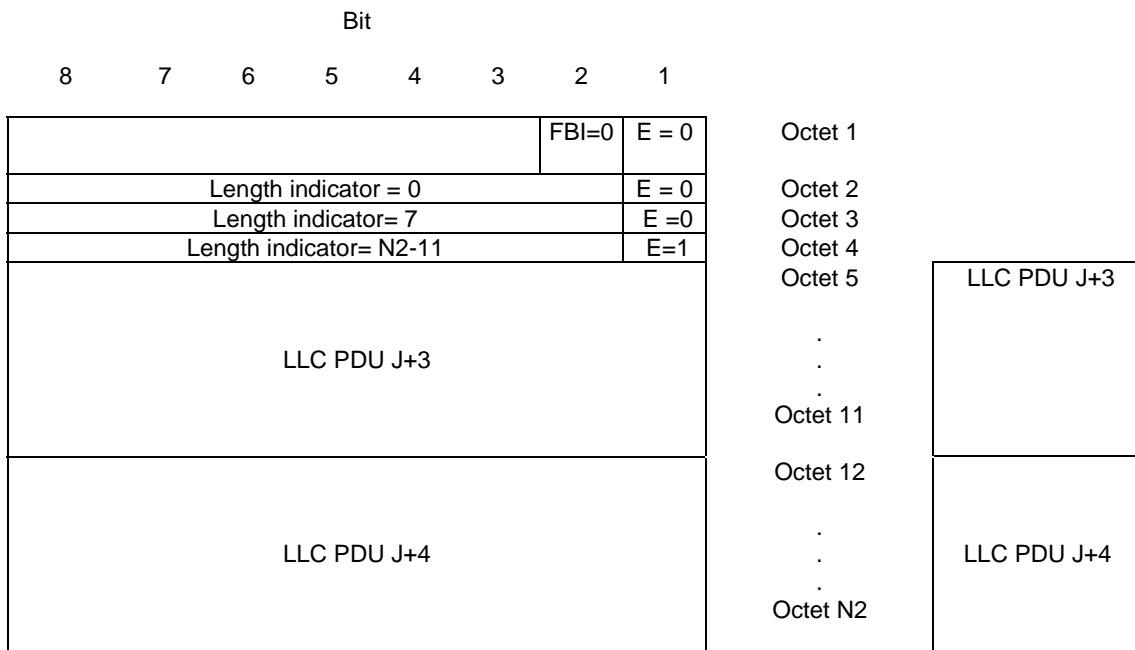

RLC Block with BSN=N (mod SNS)

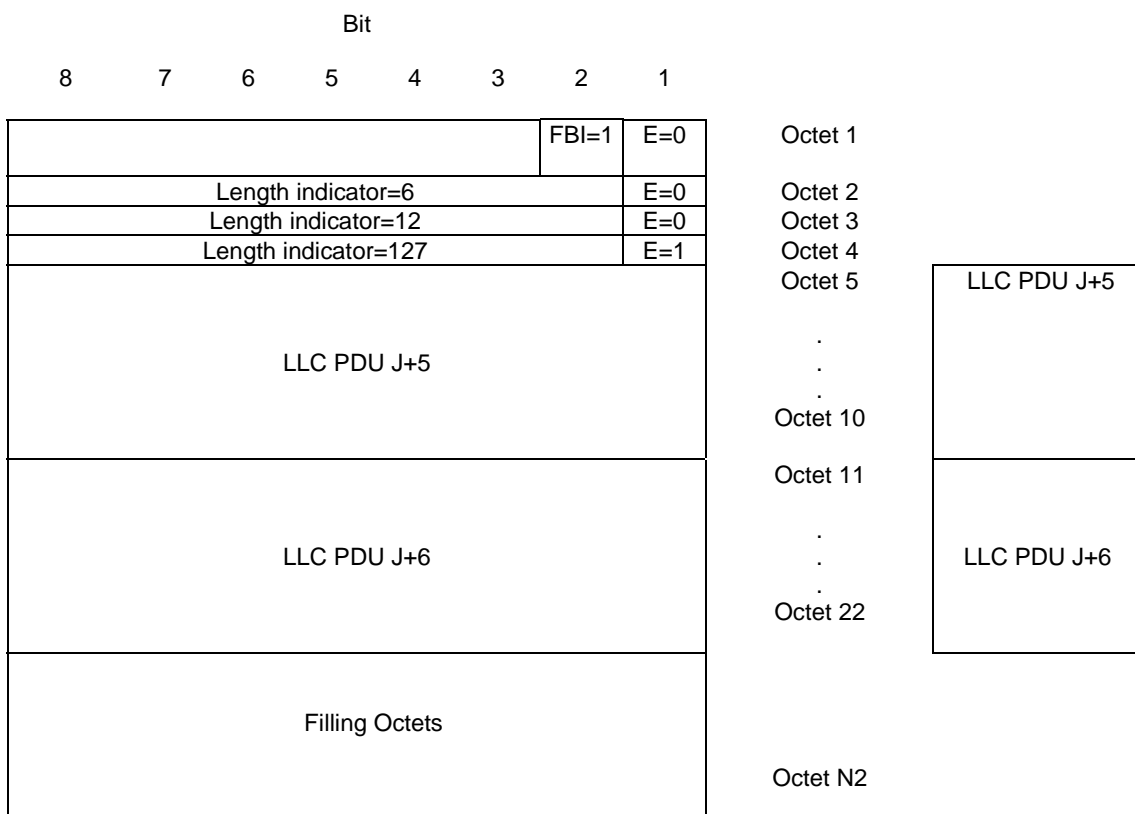

**Figure B.9: Example for the case when the LLC PDU fills exactly the RLC data block (LLC PDU J+2 and LLC PDU J+4) and when the last LLC PDU cannot not fill the last RLC data block(LLC PDU J+6)**

### B.8.3 Example 3

Figure B.10 shows a TBF of one LLC PDU which fills exactly the RLC data block (Downlink).

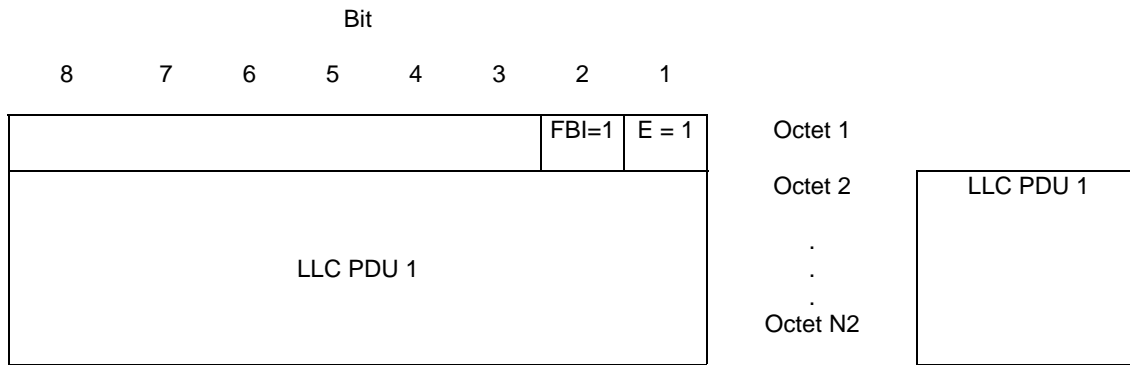

**Figure B.10: Example for the case when a LLC PDU fills the RLC data block precisely.**

### B.8.4 Example 4

Figure B.11 shows 2 RLC blocks of a TBF during RLC non-persistent mode of operation. When an LLC PDU ends in the previous RLC data block, a length indicator with value=126 is added in the next in sequence RLC data block to indicate the start of the next LLC PDU.

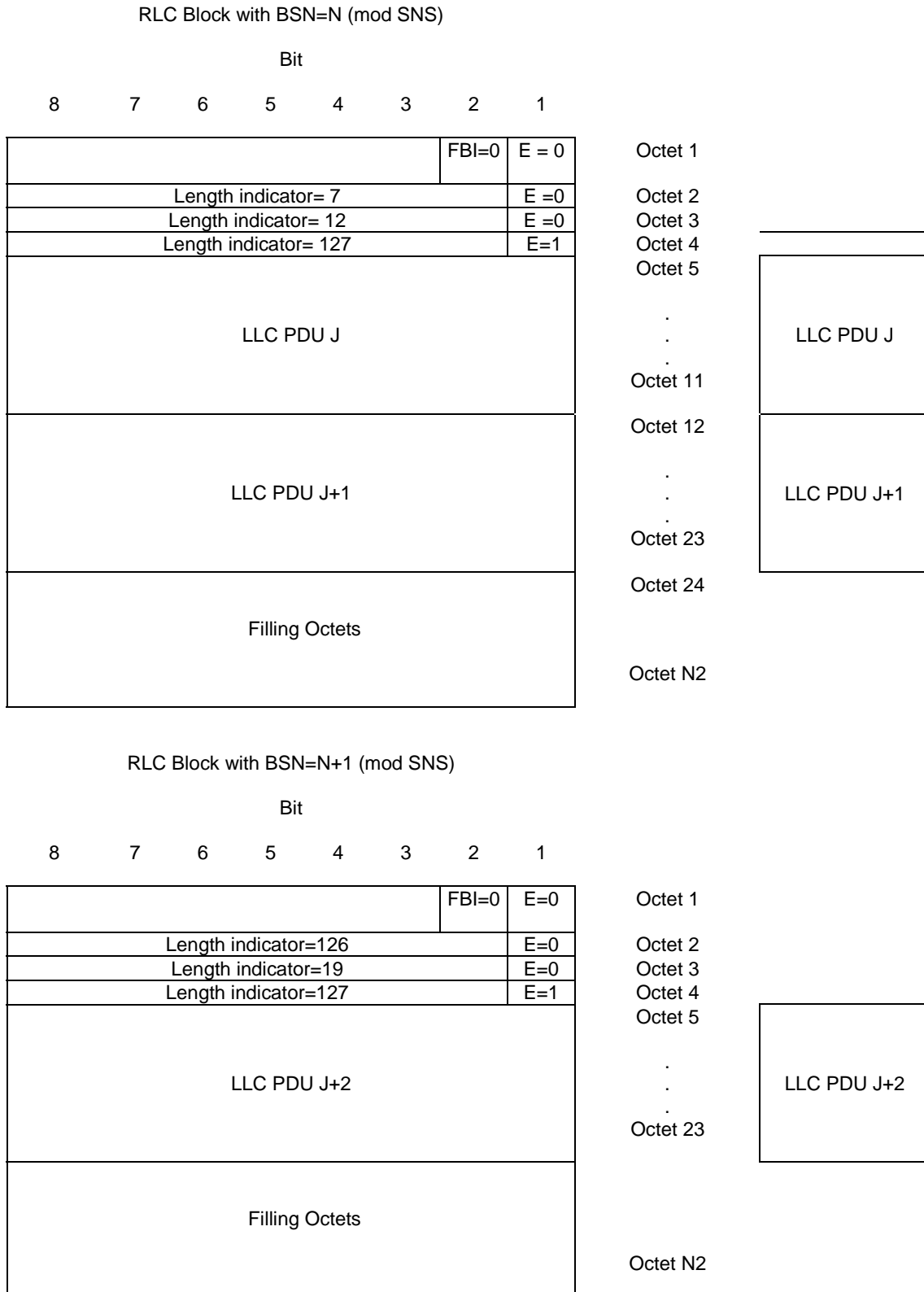

**Figure B.11: Example for the case when the LLC PDU J+1 ends in the previous RLC data block and the start of the next LLC PDU J+2 is in the next RLC data block which is indicated using LI=126 as the first LI in that RLC data block.**

# Annex C (informative): Message Sequence Diagrams

The following figures illustrate message sequences for:

- one phase mobile originated access (figure C.1); and
- network originated access (figure C.2).

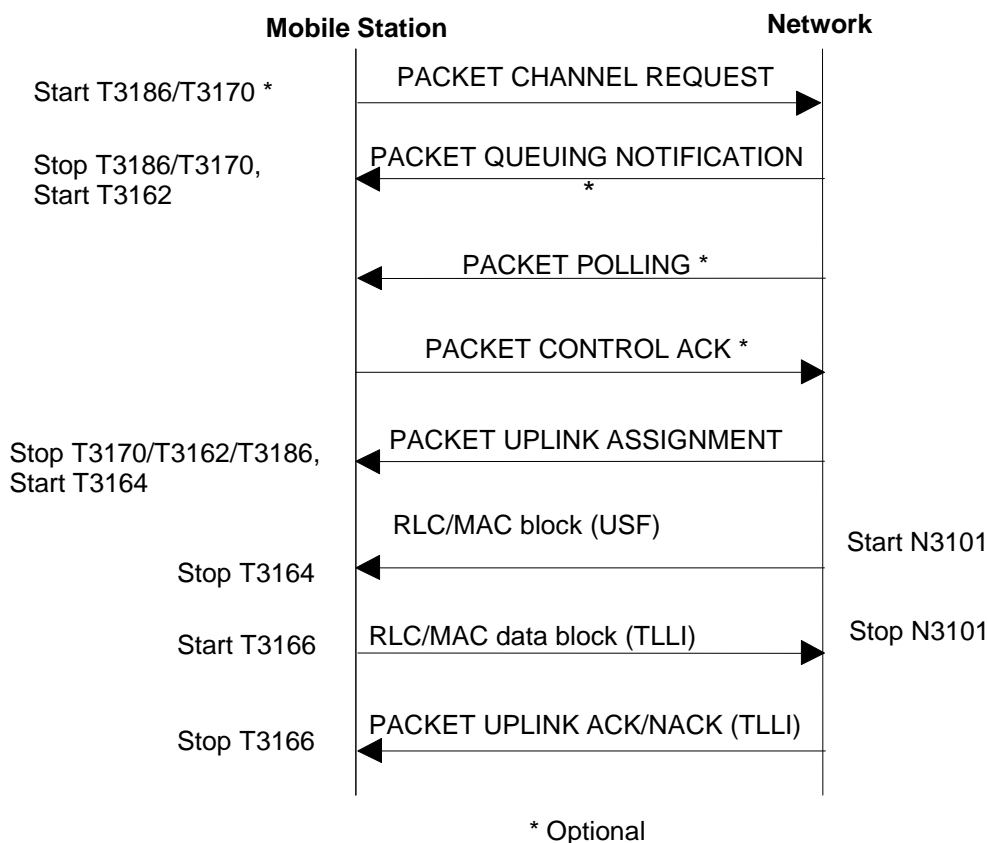

Figure C.1: Message Sequence Diagram for one phase packet access

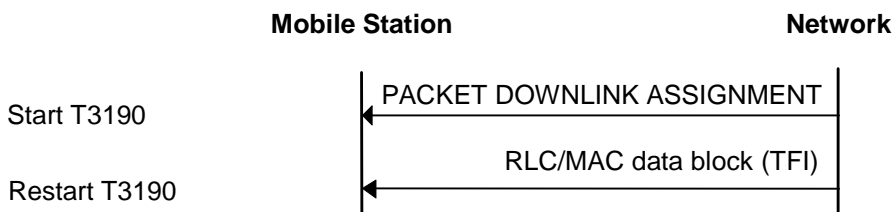

Figure C.2: TBF establishment initiated by the network



Annex D (informative):  
(void)

Annex E (informative):  
(void)

---

## Annex F (informative): Examples of Countdown procedure operation

This annex presents several examples of the countdown procedure operation.

The following parameters are used in the following examples:

TBC = total number of RLC data blocks that will be transmitted in the TBF;

BSN' = absolute block sequence number of the RLC data block, with range from 0 to (TBC - 1);

NTS = number of timeslots assigned to the uplink TBF in the assignment message, with range 1 to 8.

## F.1 Example 1

In this example, shown in the first column, the total number of RLC data blocks in the TBF (TBC) is 155, the number of timeslots (NTS) is 1, and BS\_CV\_MAX is 15. The second column shows the same example with BS\_CV\_MAX = 6.

TBC	155
NTS	1
BS_CV_MAX	15

TBC	155
NTS	1
BS_CV_MAX	6

BSN'	CV
137	15
138	15
139	15
140	14
141	13
142	12
143	11
144	10
145	9
146	8
147	7
148	6
149	5
150	4
151	3
152	2
153	1
154	0

BSN'	CV
137	15
138	15
139	15
140	15
141	15
142	15
143	15
144	15
145	15
146	15
147	15
148	6
149	5
150	4
151	3
152	2
153	1
154	0

Figure F.1: Example 1

## F.2 Example 2

In this example, shown in the first column, the total number of RLC data blocks in the TBF (TBC) is 155, the number of timeslots (NTS) is 3, and BS\_CV\_MAX is 6. Note that the RLC data block with BSN' = 154 arbitrarily occurs in timeslot 2. In the second column, the same example is shown with the RLC data block with BSN' = 154 occurring in timeslot 0.

TBC 155

NTS 3

BS\_CV\_MAX 6

TS0		TS1		TS2	
BSN'	CV	BSN'	CV	BSN'	CV
125	15	126	15	127	15
128	15	129	15	130	15
131	15	132	15	133	15
134	15	135	15	136	6
137	6	138	6	139	5
140	5	141	5	142	4
143	4	144	4	145	3
146	3	147	3	148	2
149	2	150	2	151	1
152	1	153	1	154	0

TS0		TS1		TS2	
BSN'	CV	BSN'	CV	BSN'	CV
127	15	128	15	129	15
130	15	131	15	132	15
133	15	134	15	135	15
136	6	137	6	138	6
139	5	140	5	141	5
142	4	143	4	144	4
145	3	146	3	147	3
148	2	149	2	150	2
151	1	152	1	153	1
154	0				

Figure F.2: Example 2

## F.3 Example 3

In this example, the channel coding scheme is changed at  $BSN' = 149$ , resulting in more RLC data blocks being required to complete the TBF. The value of TBC is changed from 155 to 165 at  $BSN' = 149$ .

TBC 155

NTS 3

BS\_CV\_MAX 6

TS0		TS1		TS2	
BSN'	CV	BSN'	CV	BSN'	CV
125	15	126	15	127	15
128	15	129	15	130	15
131	15	132	15	133	15
134	15	135	15	136	6
137	6	138	6	139	5
140	5	141	5	142	4
143	4	144	4	145	3
146	3	147	3	148	2
149	5	150	5	151	5
152	4	153	4	154	4
155	3	156	3	157	3
158	2	159	2	160	2
161	1	162	1	163	1
164	0				

Figure F.3: Example 3

## Annex G (informative): Handling of erroneous protocol data, examples

Procedures for the handling of erroneous protocol data are defined in sub-clause 11.1. These procedures define error labels for the treatment of syntactical errors in a received message.

### G.1 Application of error labels

An RLC/MAC control message description could have an error label included, as shown in the examples below.

```
< Packet XXX message content > ::=
  < FIELD_1 : bit (3) >
  < FIELD_2 : bit (16) >
  ...
  < padding bits >
  ! < Ignore : bit (*) = < no string > > ;
```

In the case of a complete message, the contents of the received syntactically incorrect message can be ignored.

Or

```
< PRECEDING_FIELD : bit (3) >
...
{ 00 < FIELD_1 : bit (10) >
  | 01 < FIELD_2 : bit (10) >
  ! < Ignore : bit (2+10) = < no string > > }
...
< FOLLOWING_FIELD : bit (8) >
```

The syntactically incorrect description within the { } brackets can be ignored, the correctly received descriptions preceding and following the { } brackets shall be accepted.

Or

```
< Structure 1 struct > ::=
  < FIELD_1 : bit (3) >
  { 1 < FIELD_2 : bit (8) > } ** 0
  ...
  ! < Ignore : bit (*) = < no string > > ;
```

The above description indicates that the syntactically incorrect structure can be ignored. (Note: When this structure is included in the description of a message, any description following the structure must allow truncation.)

## G.2 Application of the 'Message escape' error label

The 'Message escape' branch protects the comprehension of the description following bit '0', as shown in the example below.

```
< Packet YYY message content > ::= -- Protocol version 1
  < FIELD_1 : bit (3) >
  { 0 < FIELD_2 : bit (16) >
    ...
    < padding bits >
  ! < Message escape : 1 bit (*) = <no string> > } ;
```

The comprehension of 'FIELD\_2' is required. If the receiver detects bit '1', the 'Message escape' branch is called and the remaining part of the message can be ignored.

The 'Message escape' branch may be used to introduce an new alternative coding of the message in a later version of the protocol.

```
< Packet YYY message content > ::= -- Protocol version 2
  < FIELD_1 : bit (3) >
  { 0 < FIELD_2 : bit (16) >
    ...
    < padding bits >
  | 1 -- New code option, replacing old 'Message escape':
    { 00 < FIELD_3 : bit (12) >
      ...
      < padding bits >
    ! < Message escape : { 01 | 10 | 11 } bit (*) = <no string> > } } ;
```

An alternative coding, including 'FIELD\_3', is introduced following 'bit 1' in the former 'Message escape' branch. A new 'Message escape' is defined, this time using to control bits to allow future modification.

A receiver implemented according to the original syntax will not accept the new coding. The original 'Message escape' branch will be called and the remaining part of the message, including 'FIELD\_3' is ignored. The content of 'FIELD\_1' (e.g. information to identify the receiver) is accepted and can be used to determine appropriate condition handling.



### G.3 Application of truncated concatenation including 'padding bits'

The truncated concatenation may include 'padding bits' at the end of a message. In that case, the resulting concatenation shall fit exactly with the received message length, otherwise the message is syntactically incorrect.

The construction is useful, e.g. when a message ends with a sequence of optional components, where the transmitter may need to truncate trailing bits '0', indicating optional components not included in the message.

```
< Packet ZZZ message content > ::=
...
{ { 0 | 1 < Optional component 1 > }
  { 0 | 1 < Optional component 2 > }
...
  { 0 | 1 < Optional component N > }
  < padding bits > } // ;
```

If the optional components from k to N are not needed in the message, the transmitter may use the full message length for the components up to optional component k - 1. The receiver accepts this message and assumes that the choice bits for optional components from k to N are all set to zero (i.e. these components are not present).

However, if the receiver detects a syntactical error within one optional component which is indicated as present in the message, that results in a truncated concatenation which does not fit with the received message length. In this case, the receiver shall not accept the message as being syntactically correct.

An error label may be provided within a truncated concatenation to allow the receiver to accept part of a concatenation in case of a syntactical error within it. This is useful for recurring components at the end of a message.

```
< Packet TTT message content > ::=
...
{ { 1 { < Recurring component > ! < Ignore : bit (*) = < no string > > } } ** 0
  < padding bits > } // ;
```

If one of the recurring components is syntactically incorrect, the error branch is called. The error branch expands to the end of the message. The tail bit '0', terminating the recursion, and the 'spare padding' are truncated. The receiver accepts any syntactically correct instance of the recurring component preceding the syntactically incorrect one in the message.

## G.4 Message extension using 'padding bits'

The bit '0' in the first bit position of the 'padding bits', see sub-clause 11, may be altered into a bit '1' in future versions of the present document, in order to indicate an extension of the message content. When a message is received with bit '1' in this position, a receiver implemented according to the current version of the present document shall ignore the remaining part of the message.

The example show how a message can be extended, relying on the fact that the 'padding bits' are defined with bit '0' in the first bit position.

```
< Packet UUU message content > ::= -- Current version of the present document
  < contents defined in current version >
  < padding bits > ;
```

The presence of the extension of the message content is indicated by bit '1'. The transmitter shall send a bit '1' in this position if any content is defined for the remaining part of the message. If a bit '0' is received in this position by a receiver in the new version, it shall ignore the remaining part of the message.

```
< Packet UUU message content > ::= -- Future version of the present document
  < contents defined in current version >
  { null | 0 bit** = < no string >          -- Receiver backward compatible with earlier version
  | 1                                       -- Bit '1' sent by transmitter in new version
  < contents defined in a future version >
  < padding bits > } ;          -- New 'padding bits' allows further extension
```

## G.5 Message extension using the Extension Bits IE

The Extension Bits IE defined in sub-clause 12.26 may be used in some messages or information elements as a placeholder for future extension when an extension at the end of the message is less suitable. The Extension Bits IE is usually included as an optional or conditional information element. When included, it provides a length indication and a corresponding set of "spare bits", which may be used in future versions of the protocol to carry an extension of the message contents.

When this extension mechanism is applied, the original Extension Bits IE shall be removed from the message and replaced by a new information element or a new construction, carrying an extension by up to 64 bits of the message contents. An example is given below.

```

< Packet VVV message content > ::= -- Current (original) version of the present document
...
{ 0 | 1 < Extension Bits : Extension Bits IE > }      -- sub-clause 12.26
...
< padding bits > ;

```

The Extension Bits IE is replaced by a new construction named "VVV Extension Info". The new construction includes extensions introduced in Rel-M and Rel-N. In order to enable backward compatibility, truncation of the extension information may occur between released versions of the protocol. The receiver shall assume the value zero of any truncated bits. In order to enable forward compatibility, additional "spare bits" may occur after the defined extensions.

```

< Packet VVV message content > ::= -- Future version of the present document; extensions in Rel-M and Rel-N
...
{ 0 | 1 < VVV Extension length : bit (6) >
  < bit (val(VVV Extension length) + 1)
    & { < VVV Extension Info > ! { bit** = <no string> } } > }
...
< padding bits > ;

< VVV Extension Info > ::=
{ {
  -- Rel-M extension
  < Extension in Rel-M > }
{
  -- Rel-N extension
  < Extension in Rel-N > }
< spare bit >** } // ;
-- Truncation may occur between released versions of the protocol
-- The receiver shall assume the value zero of any truncated bits

```

Annex H (informative):  
(void)

---

## Annex I (informative): EGPRS RLC Window Sizes

Although for each multislot allocation, the selected window size could preferably be the maximum, a smaller window size may be selected in order to optimize e.g. the number of (multislot) users and network memory consumption.

However, for each MS, in order to meet a performance which corresponds to the number of timeslots assigned to this MS, the selected window size shall not be smaller than a minimum window size for this particular multislot allocation.

For each network, the round-trip delay has a direct implication on the performance, hence on the definition of the minimum window sizes. Consequently, no generic minimum window sizes are suggested. However, for information, the table below lists the window size ranges recommended with a round-trip delay of about 120 ms.

For a mobile station in DLMC configuration the downlink window size is the same as the supported buffer size (see Table 9.1.9.3.2) whereas uplink window sizes shall still be managed as per EGPRS TBF mode without a DLMC configuration (see sub-clause 9.1.9.3).

Window size	Coding	Timeslots assigned (Multislot capability)							
		1	2	3	4	5	6	7	8-16

64	00000	Min							
96	00001		Min						
128	00010								
160	00011			Min	Min				
192	00100	Max							
224	00101					Min			
256	00110		Max						
288	00111								
320	01000						Min		
352	01001							Min	
384	01010			Max					
416	01011								
448	01100								
480	01101								
512	01110				Max				Min
544	01111								
576	10000								
608	10001								
640	10010					Max			
672	10011								
704	10100								
736	10101								
768	10110						Max		
800	10111								
832	11000								
864	11001								
896	11010							Max	
928	11011								
960	11100								
992	11101								
1024	11110								Max
Reserved	11111	x	X	x	x	x	x	x	X

# Annex J (informative): An example of MCS-8 retransmission

This example shows the radio blocks of an MCS-8 RLC data block retransmitted using MCS-6 (padding) and MCS-3 (padding).

The following hypothesis are used:

- Uplink block;
- The MCS-8 RLC data block contains three LLC PDU: last part of LLC1 (last 40 octets), the whole LLC2 (length 60 octets) and the first part of LLC3 (first 34 octets);
- No TLLI nor PFI is present.

## J.1 Original MCS-8 RLC data block

8	7	6	5	4	3	2	1	Octet
TFI		Countdown Value			SI	R		1 (header)
BSN1				TFI				2 (header)
BSN 2		BSN 1						3 (header)
BSN2								4 (header)
Spare	PI	RSB	CPS					5 (header)
Spare								(See note below)
						TI	E	
Length indicator = 40							E	1 (RLC data 1)
LLC1 (octet 1)								2 (RLC data 1)
LLC1 (octet 2)								3 (RLC data 1)
::								:
LLC1 (octet 39)								40 (RLC data 1)
LLC1 (octet 40)								41 (RLC data 1)
LLC2 (octet 1)								42 (RLC data 1)
LLC2 (octet 2)								43 (RLC data 1)
::								:
LLC2 (octet 26)								67 (RLC data 1)
LLC2 (octet 27)								68 (RLC data 1)
						TI	E	(See note below)
Length indicator = 33							E	1 (RLC data 2)
LLC2 (octet 28)								2 (RLC data 2)
LLC2 (octet 29)								3 (RLC data 2)
::								:
LLC2 (octet 59)								33 (RLC data 2)
LLC2 (octet 60)								34 (RLC data 2)
LLC3 (octet 1)								35 (RLC data 2)
LLC3 (octet 2)								36 (RLC data 2)
::								:
LLC3 (octet 33)								67 (RLC data 2)
LLC3 (octet 34)								68 (RLC data 2)

NOTE: At this row, only a few bits are sent (not a full octet).

## J.2 Retransmission in two MCS-6 RLC data blocks

When this RLC data block is repeated using MCS-6 (padding), the two radio blocks have the following format:

8	7	6	5	4	3	2	1	Octet
TFI		Countdown value			SI	R		1 (header)
BSN 1				TFI				2 (header)
CPS		BSN 1						3 (header)
Spare			PI		RSB	CPS		4 (header)
Spare			Spare					(See note below)
Padding								1 (RLC data)
::								:
Padding								6 (RLC data)
(See note below)								(See note below)
TI						E		7 (RLC data)
Length indicator = 40								8 (RLC data)
LLC1 (octet 1)								9 (RLC data)
LLC1 (octet 2)								:
::								:
LLC1 (octet 39)								46 (RLC data)
LLC1 (octet 40)								47 (RLC data)
LLC2 (octet 1)								48 (RLC data)
LLC2 (octet 2)								49 (RLC data)
::								:
LLC2 (octet 26)								73 (RLC data)
LLC2 (octet 27)								74 (RLC data)

8	7	6	5	4	3	2	1	Octet
TFI		Countdown value			SI	R		1 (header)
BSN 1				TFI				2 (header)
CPS		BSN 1						3 (header)
Spare			PI		RSB	CPS		4 (header)
Spare			Spare					(See note below)
Padding								1 (RLC data)
::								:
Padding								6 (RLC data)
(See note below)								(See note below)
TI						E		7 (RLC data)
Length indicator = 33								8 (RLC data)
LLC2 (octet 28)								9 (RLC data)
LLC2 (octet 29)								:
::								:
LLC2 (octet 59)								39 (RLC data)
LLC2 (octet 60)								40 (RLC data)
LLC3 (octet 1)								41 (RLC data)
LLC3 (octet 2)								42 (RLC data)
::								:
LLC3 (octet 33)								73 (RLC data)
LLC3 (octet 34)								74 (RLC data)

NOTE: At this row, only a few bits are sent (not a full octet).



### J.3 Retransmission in four MCS-3 RLC data blocks

When the original RLC data block is repeated using MCS-3, the four radio blocks have the following format:

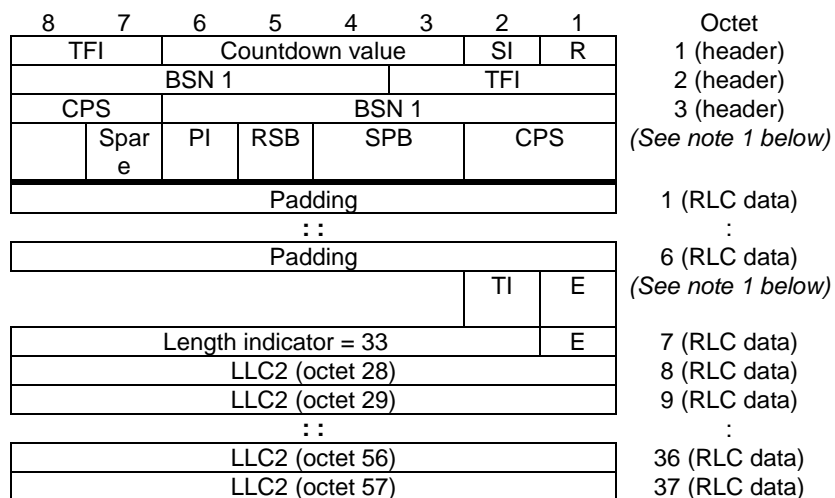
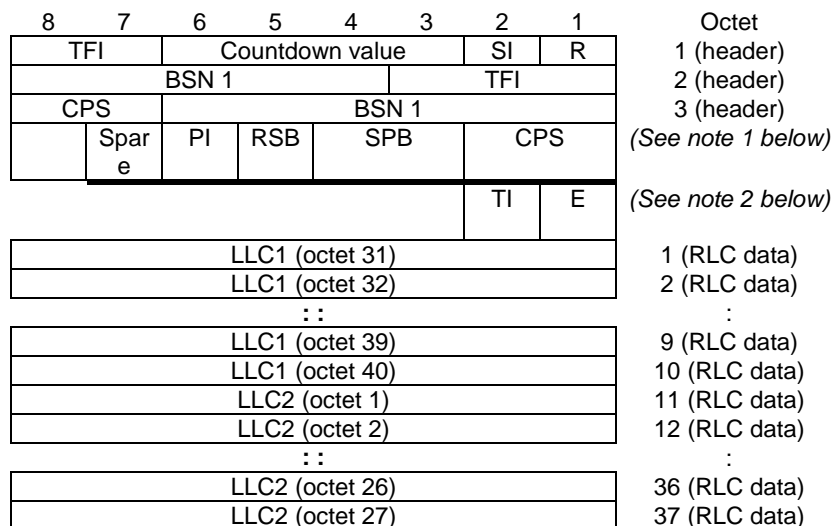
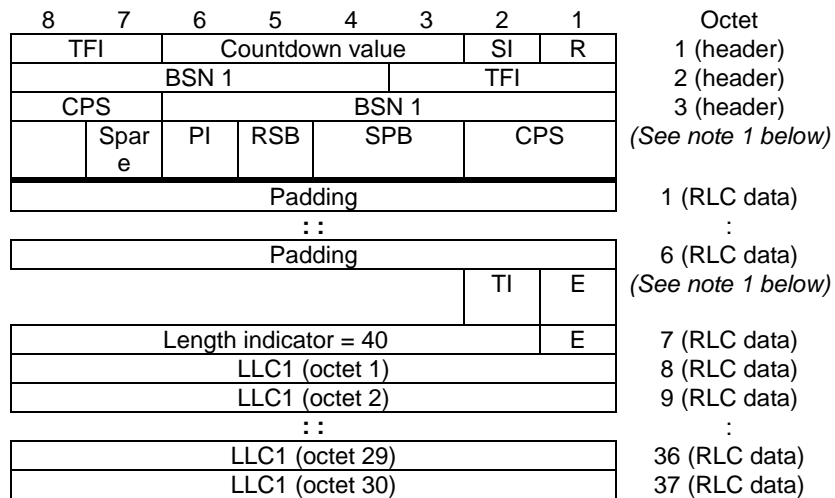

8	7	6	5	4	3	2	1	Octet
TFI		Countdown value				SI	R	1 (header)
BSN 1				TFI				2 (header)
CPS		BSN 1						3 (header)
	Spare	PI	RSB	SPB		CPS		(See note 1 below)
						TI	E	(See note 2 below)
LLC2 (octet 58)								1 (RLC data)
LLC2 (octet 59)								2 (RLC data)
LLC2 (octet 60)								3 (RLC data)
LLC3 (octet 1)								4 (RLC data)
LLC3 (octet 2)								5 (RLC data)
::								:
LLC3 (octet 33)								36 (RLC data)
LLC3 (octet 34)								37 (RLC data)

NOTE 1: At this row, only a few bits are sent (not a full octet).

NOTE 2: In this radio block, the bits TI / E are meaningless.

## Annex K (informative): Signalling uplink assignments for Downlink Dual Carrier and/or RTTI or MTTI configurations

In the PACKET UPLINK ASSIGNMENT and PACKET TIMESLOT RECONFIGURE, uplink assignments may include the Dynamic Allocation 2 struct.

The maximum number of USFs, timeslots and PDCH pairs for which allocations are made (i.e. the maximum value of  $N\_USF + 1$ ,  $N\_TS + 1$  and  $N\_PAIRS + 1$ , respectively), and hence the maximum number of repetitions of the subsequent fields and structures, are as follows:

Assignment Type	RTTI/MTTI configuration	USF mode (applicable to RTTI configurations only)	Maximum value of ( $N\_USF + 1$ )	Maximum value of ( $N\_TS + 1$ )	Maximum value of ( $N\_PAIRS + 1$ )
Single Carrier Assignment (Note 1)	No		8	8	n/a
	Yes	RTTI	4	n/a	4
	Yes	BTTI	8	n/a	4
Dual Carrier Assignment	No		16	16	n/a
	Yes	RTTI	8	n/a	8
	Yes	BTTI	16	n/a	8

NOTE 1: This applies when the Assignment Type field indicates "Assignment on single carrier only" or "Modification of Existing Assignment"

The order of USF assignment for RTTI assignments is as shown in the table below. PN<sub>x</sub> stands for PDCH pair number x, where PDCH pairs are ordered according to the timeslot numbers of their constituent PDCHs. The prefixes C1 and C2 indicate the resources on carrier 1 and carrier 2 respectively. The subscript 'a' (respectively 'b') indicates that the USF applies to the first two (respectively second two) TDMA frames of the following basic radio block period (see sub-clauses 8.1.1.1.1, 8.1.1.2.1).

Assignment Type	RTTI configuration	Order of USF assignments	Order of USF assignments (RTTI mode with BTTI USF, without power control parameters)
Single Carrier Assignment (Note 1)	No	TN0, ...TN7	n/a
Single Carrier Assignment (Note 1)	Yes	PN0, ..PN3 (Note 2)	PN0a, PN0b, PN1a, ... PN3b (Note 2)
Dual Carrier Assignment	No	C1/TN0, ...C1/TN7, C2/TN0, ...C2/TN7	n/a
Dual Carrier Assignment	Yes	C1/PN0, ...C1/PN3, C2/PN0, ...C2/PN3 (Note 2)	C1/PN0a, C1/PN0b, C1/PN1a, ... C1/PN3b, C2/PN0a, C2/PN0b, C2/PN1a, ... C2/PN3b (Note 2)

NOTE 1: This applies when the Assignment Type field is included and indicates "Assignment on single carrier only" or "Modification of Existing Assignment"

NOTE 2: In a RTTI configuration, the table assumes a default PDCH pair configuration on each carrier (see sub-clause 7.1.3.6). If fewer than four PDCH pairs are configured on a carrier the maximum value of  $N\_USF$  or  $N\_PAIRS$  is correspondingly reduced and the list contains only the PDCH pairs in the PDCH pair configuration, e.g. if there are 3 PDCH pairs configured on each carrier, the order of USF assignments for a Downlink Dual Carrier, RTTI configuration is C1/PN0 ... C1/PN2, C2/PN0 ... C2/PN2.

If the value of  $(N\_USF + 1)$ ,  $(N\_TS + 1)$  or  $(N\_PAIRS + 1)$  is lower than the maximum, then the list of USF assignments is truncated, and there is (implicitly) no assignment for the timeslots/PDCH pairs for which no corresponding value is present.

For MTTI configurations, the order of USF assignments for PDCH-pairs is as shown above for RTTI assignments. In addition, the last assigned USF(s) applies to the PDCH on carrier 1 (if assigned) and then to the PDCH on carrier 2 (if assigned).

## Annex L (informative): MultislotClassGroup in EGPRS Packet Channel Request

In the EGPRS PACKET CHANNEL REQUEST message with cause "One Phase Access Request by Reduced Latency MS", the mobile station multislot class is signalled by the MultislotClassGroup. The MultislotClassGroup indicates the set of the EGPRS multislot classes to which the mobile station belongs. Supported multislot class configurations are limited by the maximum transition times ( $T_{ta}$ ,  $T_{tb}$ ,  $T_{ra}$ ,  $T_{rb}$ ) and the minimum number of RX, TX and SUM slots common to the multislot classes in each set as follows (see also 3GPP TS 45.002)

MultislotClassGroup	Maximum number of slots			Minimum number of slots			
	Rx	Tx	Sum	$T_{ta}$	$T_{tb}$	$T_{ra}$	$T_{rb}$
0 0 0	2	2	4	3	1	3	1
0 0 1	3	2	5	3	1	2	1
0 1 0	5	2	6	2	1	1+to	1
0 1 1	4	3	5	2	1	2	1
1 0 0	5	4	6	2	1	1	1
1 0 1	5	4	6	2	1	1+to	1
1 0 1	6	5	7	1	1	1	to
1 1 1	reserved						

# Annex M (informative): MTTI Assignments and allocations

MTTI assignments are described in sub-clause 7.1.3.7. Examples of valid MTTI assignments are shown in Figures M.1 and M.2. The examples shown in Figure M.1 may be used for either uplink or downlink TBFs. Examples of MTTI assignments that are not permitted and cannot be assigned are shown in Figure M.3.

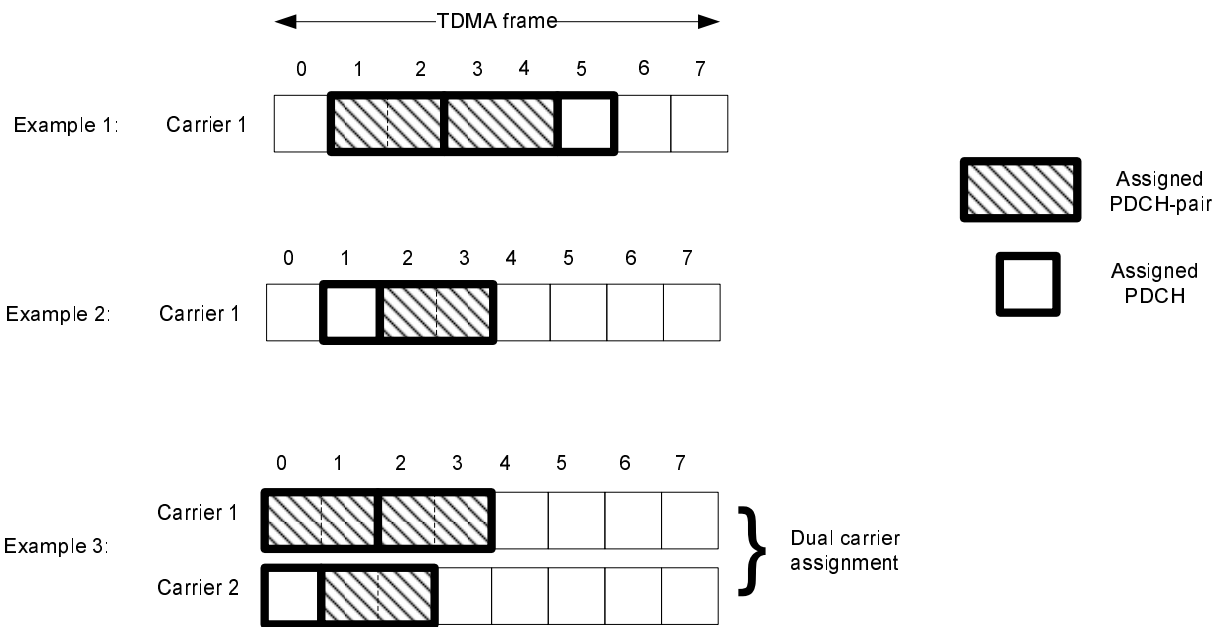

**Figure M.1: Valid MTTI assignments (single TBF)**

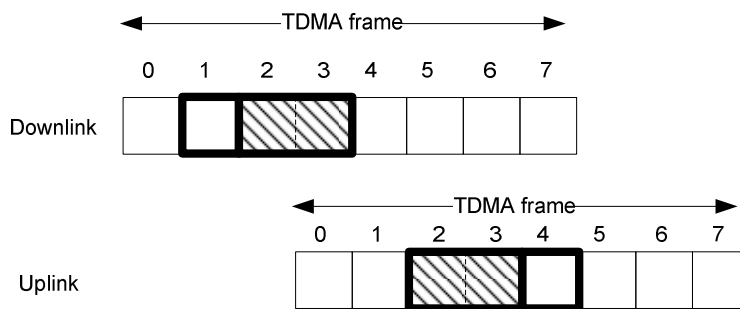

**Figure M.2: Valid MTTI assignment (1 uplink TBF & 1 downlink TBF)**

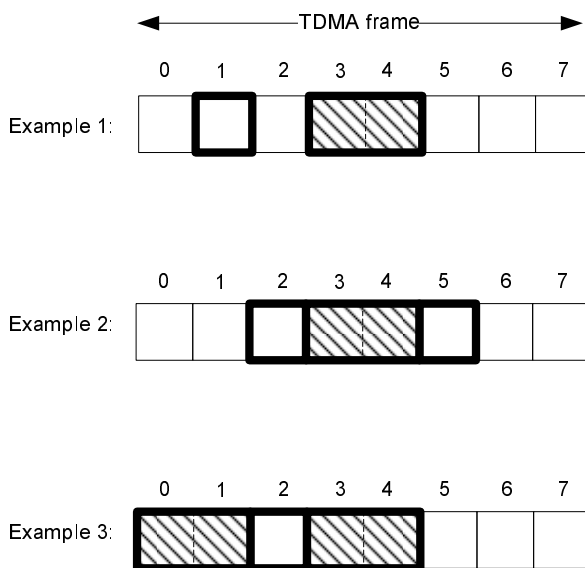

Figure M.3: Invalid MTTI assignments

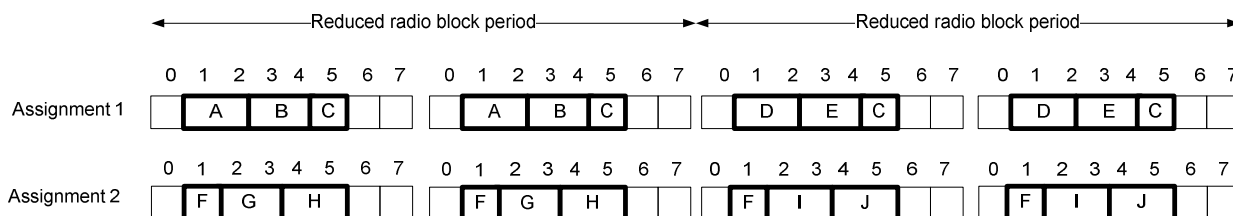

Figure M.4: Example MTTI assignments

Figure M.4 shows two reduced radio block periods for each of two possible MTTI configurations, during which the mobile station may be allocated resources to transmit RTTI radio blocks (A,B,D,E for Assignment 1 and G,H,I and J for Assignment 2) and/or BTTI radio blocks (C for Assignment 1 and F for Assignment 2). Tables M.1 and M.2 show which radio block(s) are allocated, depending on the timeslot(s) in the previous basic radio block period on which assigned USF(s) were received.

Table M.1: Example MTTI allocations – BTTI USF mode with EDA : Assignment 1

Assigned USF received on TN:	Allocated blocks				
	A	B	C	D	E
1	X	X	X		
2				X	X
3		X	X		
4					X
5			X		

Table M.2: Example MTTI allocations – BTTI USF mode with EDA : Assignment 2

Assigned USF received on TN	Allocated blocks				
	F	G	H	I	J
1	X	X	X	X	X
2		X	X		
3				X	X
4			X		
5					X

## Annex N (normative): Uplink Radio Block Transmission order for EFTA

A mobile station with an uplink TBF operating in BTTI configuration for which EFTA is used shall perform transmissions on a subset of the uplink PDCHs allocated by the USF. If the mobile station has P RLC/MAC blocks ready for transmission, then this subset is defined as the first P number of the allocated uplink PDCHs arranged according to the specific timeslot numbers order as specified in Table N.1 below.  $T_{ra}$  or  $T_{rb}$ , whichever is applicable, is the switching time from transmission to reception (see 3GPP TS 45.002).

**Table N.1: Uplink timeslots transmission order for EFTA**

Lowest Numbered Downlink Timeslot the MS Needs to Monitor	$T_{ra}$ or $T_{rb}$ , whichever is applicable		
	0	1	2
TN0	4,3,2,1,0,5,6,7	3,2,1,0,4,5,6,7	2,1,0,3,4,5,6,7
TN1	5,4,3,2,1,0,6,7	4,3,2,1,0,5,6,7	3,2,1,0,4,5,6,7
TN2	6,5,4,3,2,1,0,7	5,4,3,2,1,0,6,7	4,3,2,1,0,5,6,7
TN3	7,6,5,4,3,2,1,0	6,5,4,3,2,1,0,7	5,4,3,2,1,0,6,7
TN4	7,6,5,4,3,2,1,0	7,6,5,4,3,2,1,0	6,5,4,3,2,1,0,7
TN5	7,6,5,4,3,2,1,0	7,6,5,4,3,2,1,0	7,6,5,4,3,2,1,0
TN6	7,6,5,4,3,2,1,0	7,6,5,4,3,2,1,0	7,6,5,4,3,2,1,0
TN7	7,6,5,4,3,2,1,0	7,6,5,4,3,2,1,0	7,6,5,4,3,2,1,0

A mobile station with an uplink TBF operating in RTTI configuration for which EFTA is used shall perform transmissions on a subset of the uplink PDCH-pairs allocated by the USF in the same manner as specified above. For this case the specific timeslot number order shall be seen as indicating the lowest numbered timeslot of the uplink PDCH-pair.

**NOTE:** The above described rule determine the subset of the allocated uplink PDCHs or PDCH-pairs on which uplink transmissions shall be performed when EFTA is used. This procedure however, does not define which uplink PDCHs or PDCH-pairs that shall be allocated by the USF. Nor does the procedure define the individual ordering of any transmitted RLC/MAC blocks on these resources, which shall remain the same as for the case when EFTA is not used.

A mobile station with an uplink TBF for which EFTA is used shall perform the transmission of any uplink PACCH message allocated via the polling mechanism (see sub-clauses 10.4.4b and 10.4.5) on the first of the assigned uplink PDCHs or PDCH-pairs arranged according to the specific timeslot number order as described by Table N.1 above, regardless of which resources are allocated by the USF. The switching time  $T_{ra}$  or  $T_{rb}$  shall be interpreted according to its value at the time the poll was received.

The following example is considered for illustration of the above rules:

- A mobile station is assigned an uplink TBF in BTTI configuration for which EFTA is used.
- This mobile station is allocated uplink PDCHs on TN0, TN1, TN2 and TN3 during the radio block period considered.
- This mobile station only has 3 RLC/MAC blocks available for transmission, out of which one is a PACCH message allocated via the polling mechanism.
- The lowest numbered downlink timeslot the mobile station has to monitor is TN0 and that the applicable switching time  $T_{rb}$  is 1.

According to the above description, the mobile station shall then transmit its PACCH message on TN3, whereas the remaining RLC/MAC blocks shall be transmitted on TN1 and TN2 respectively.



---

## Annex O (informative): Change History

Meeting / Date	Tdoc	CR	Rev	Subject	New Version
March 2013	-	-	-	Generation of version 12.0.0 (Rel-12), based upon v11.8.0.	12.0.0
GP-61	GP-140226	1598	2	Introduction of MFBI-support in GERAN	12.0.0
GP-62	GP-140380	1586	10	Introduction of Downlink Multi Carrier	12.1.0
GP-63	GP-140622	1604		Downlink Multi Carrier - Implementation Corrections	12.2.0
GP-63	GP-140621	1602		Downlink Multi Carrier Support of EMSR	12.2.0
GP-63	GP-140707	1600	3	MFBI support in idle mode	12.2.0
GP-64	GP-140956	1599	4	Introduction of extended TSC sets	12.3.0

---

# History

<b>Document history</b>		
V12.2.0	September 2014	Publication
V12.3.0	January 2015	Publication