

# ETSI TS 145 002 V15.2.0 (2020-04)



**Digital cellular telecommunications system (Phase 2+) (GSM);  
GSM/EDGE Multiplexing and multiple access on the radio path  
(3GPP TS 45.002 version 15.2.0 Release 15)**



---

Reference

RTS/TSGR-0645002vf20

---

Keywords

GSM

**ETSI**

650 Route des Lucioles  
F-06921 Sophia Antipolis Cedex - FRANCE

Tel.: +33 4 92 94 42 00 Fax: +33 4 93 65 47 16

Siret N° 348 623 562 00017 - NAF 742 C  
Association à but non lucratif enregistrée à la  
Sous-Préfecture de Grasse (06) N° 7803/88

---

**Important notice**

The present document can be downloaded from:

<http://www.etsi.org/standards-search>

The present document may be made available in electronic versions and/or in print. The content of any electronic and/or print versions of the present document shall not be modified without the prior written authorization of ETSI. In case of any existing or perceived difference in contents between such versions and/or in print, the prevailing version of an ETSI deliverable is the one made publicly available in PDF format at [www.etsi.org/deliver](http://www.etsi.org/deliver).

Users of the present document should be aware that the document may be subject to revision or change of status.

Information on the current status of this and other ETSI documents is available at

<https://portal.etsi.org/TB/ETSIDeliverableStatus.aspx>

If you find errors in the present document, please send your comment to one of the following services:

<https://portal.etsi.org/People/CommiteeSupportStaff.aspx>

---

**Copyright Notification**

No part may be reproduced or utilized in any form or by any means, electronic or mechanical, including photocopying and microfilm except as authorized by written permission of ETSI.

The content of the PDF version shall not be modified without the written authorization of ETSI.

The copyright and the foregoing restriction extend to reproduction in all media.

© ETSI 2020.

All rights reserved.

**DECT™**, **PLUGTESTS™**, **UMTS™** and the ETSI logo are trademarks of ETSI registered for the benefit of its Members.

**3GPP™** and **LTE™** are trademarks of ETSI registered for the benefit of its Members and of the 3GPP Organizational Partners.

**oneM2M™** logo is a trademark of ETSI registered for the benefit of its Members and of the oneM2M Partners.

**GSM®** and the GSM logo are trademarks registered and owned by the GSM Association.

---

## Intellectual Property Rights

### Essential patents

IPRs essential or potentially essential to normative deliverables may have been declared to ETSI. The information pertaining to these essential IPRs, if any, is publicly available for **ETSI members and non-members**, and can be found in ETSI SR 000 314: "*Intellectual Property Rights (IPRs); Essential, or potentially Essential, IPRs notified to ETSI in respect of ETSI standards*", which is available from the ETSI Secretariat. Latest updates are available on the ETSI Web server (<https://ipr.etsi.org/>).

Pursuant to the ETSI IPR Policy, no investigation, including IPR searches, has been carried out by ETSI. No guarantee can be given as to the existence of other IPRs not referenced in ETSI SR 000 314 (or the updates on the ETSI Web server) which are, or may be, or may become, essential to the present document.

### Trademarks

The present document may include trademarks and/or tradenames which are asserted and/or registered by their owners. ETSI claims no ownership of these except for any which are indicated as being the property of ETSI, and conveys no right to use or reproduce any trademark and/or tradename. Mention of those trademarks in the present document does not constitute an endorsement by ETSI of products, services or organizations associated with those trademarks.

---

## Legal Notice

This Technical Specification (TS) has been produced by ETSI 3rd Generation Partnership Project (3GPP).

The present document may refer to technical specifications or reports using their 3GPP identities. These shall be interpreted as being references to the corresponding ETSI deliverables.

The cross reference between 3GPP and ETSI identities can be found under <http://webapp.etsi.org/key/queryform.asp>.

---

## Modal verbs terminology

In the present document "**shall**", "**shall not**", "**should**", "**should not**", "**may**", "**need not**", "**will**", "**will not**", "**can**" and "**cannot**" are to be interpreted as described in clause 3.2 of the [ETSI Drafting Rules](#) (Verbal forms for the expression of provisions).

"**must**" and "**must not**" are **NOT** allowed in ETSI deliverables except when used in direct citation.

# Contents

Intellectual Property Rights .....	2
Legal Notice .....	2
Modal verbs terminology.....	2
Foreword.....	7
1 Scope .....	8
1.1 References .....	8
1.2 Abbreviations .....	9
1.2a Definitions .....	9
1.3 Restrictions.....	9
2 General .....	9
3 Logical channels.....	10
3.1 General .....	10
3.2 Traffic channels.....	10
3.2.1 General.....	10
3.2.2 Speech traffic channels .....	10
3.2.3 Circuit switched data traffic channels .....	11
3.2.4 Packet data traffic channels (PDTCH and EC-PDTCH).....	11
3.3 Control channels.....	12
3.3.1 General.....	12
3.3.2 Broadcast channels .....	12
3.3.2.1 Frequency correction channels (FCCH and CFCCCH) .....	12
3.3.2.2 Synchronization channels.....	12
3.3.2.2.0 General .....	12
3.3.2.2.1 Synchronization channel (SCH) .....	12
3.3.2.2.2 COMPACT synchronization channel (CSCH).....	12
3.3.2.2.3 Extended Coverage synchronization channel (EC-SCH) .....	13
3.3.2.3 Broadcast control channel (BCCH).....	14
3.3.2.3a Extended coverage broadcast control channel (EC-BCCH).....	14
3.3.2.4 Packet Broadcast Control Channels .....	15
3.3.2.4.1 Packet Broadcast Control Channel (PBCCH) .....	15
3.3.2.4.2 COMPACT Packet Broadcast Control Channel (CPBCCH).....	15
3.3.3 Common control type channels .....	16
3.3.3.1 Common control type channels, known when combined as a common control channel (CCCH).....	16
3.3.3.2 Packet Common control channels .....	16
3.3.3.2.1 Packet Common Control Channels (PCCCH).....	16
3.3.3.2.2 COMPACT Common Control Channels (CPCCCH).....	16
3.3.3.2.3 MBMS Common Control Channels .....	16
3.3.3.3 Extended Coverage Common Control Channels.....	16
3.3.4 Dedicated control channels.....	17
3.3.4.1 Circuit switched dedicated control channels .....	17
3.3.4.2 Packet dedicated control channels.....	17
3.3.4.3 Extended Coverage Packet dedicated control channels .....	17
3.3.5 Cell Broadcast Channel (CBCH) .....	18
3.3.6 CTS control channels.....	18
3.3.6.1 CTS beacon channel (BCH).....	18
3.3.6.2 CTS paging channel (CTSPCH) .....	18
3.3.6.3 CTS access request channel (CTSARCH) .....	18
3.3.6.4 CTS access grant channel (CTSAGCH) .....	18
3.4 Combination of channels.....	18
4 The physical resource.....	19
4.1 General .....	19
4.2 Radio frequency channels.....	19
4.2.1 Cell allocation and mobile allocation.....	19
4.2.2 Downlink and uplink .....	19

4.3	Timeslots, TDMA frames, and time groups .....	19
4.3.1	General.....	19
4.3.2	Timeslot number.....	19
4.3.3	TDMA frame number .....	20
4.3.4	Time group.....	20
5	Physical channels .....	20
5.1	General .....	20
5.2	Bursts.....	20
5.2.1	General.....	20
5.2.2	Types of burst and burst timing .....	20
5.2.3	Normal burst (NB).....	22
5.2.3.1	Normal burst for GMSK .....	22
5.2.3.2	Normal burst for AQPSK (downlink only) .....	24
5.2.3.3	Normal burst for 8PSK.....	24
5.2.3.4	Normal burst for 16QAM.....	25
5.2.3.5	Normal burst for 32QAM.....	27
5.2.3a	Higher symbol rate burst (HB) .....	28
5.2.4	Frequency correction burst (FB).....	31
5.2.5	Synchronization Burst (SB).....	32
5.2.6	Dummy burst (DB).....	32
5.2.7	Access burst (AB).....	33
5.2.8	Guard period .....	34
5.2.9	Extended Access burst (Extended AB).....	34
5.2.10	Extended Synchronization Access burst (ESAB) .....	35
5.2.11	Extended Dual Slot Access burst (EDAB) .....	35
5.3	Physical channels and bursts .....	37
5.4	Radio frequency channel sequence .....	37
5.5	Timeslot and TDMA frame sequence .....	37
5.6	Parameters for channel definition and assignment .....	37
5.6.1	General.....	37
5.6.2	General parameters .....	37
5.6.2.1	General .....	37
5.6.2.2	COMPACT .....	37
5.6.2.3	EC-GSM-IoT .....	38
5.6.3	Specific parameters.....	38
6	Mapping of logical channels onto physical channels .....	38
6.1	General .....	38
6.2	Mapping in frequency of logical channels onto physical channels .....	39
6.2.1	General.....	39
6.2.2	Parameters.....	39
6.2.3	Hopping sequence generation .....	40
6.2.4	Specific cases.....	41
6.2.5	Change in the frequency allocation of a base transceiver station.....	42
6.2.6	Frequency assignment in CTS .....	42
6.2.7	Mapping restrictions in downlink multi-carrier configurations .....	42
6.3	Mapping in time of logical channels onto physical channels .....	43
6.3.1	Mapping in time of circuit switched logical channels onto physical channels .....	43
6.3.1.1	General .....	43
6.3.1.2	Key to the mapping table of clause 7 .....	43
6.3.1.3	Mapping of BCCH data .....	44
6.3.1.4	Mapping of SID Frames.....	46
6.3.2	Mapping in time of packet logical channels onto physical channels .....	46
6.3.2.1	General .....	46
6.3.2.2	Mapping of the uplink channels .....	48
6.3.2.2.1	Mapping of (EC-)PDTCH/U and (EC-)PACCH/U .....	48
6.3.2.2.1.1	BTTI configuration .....	48
6.3.2.2.1.2	RTTI configuration .....	49
6.3.2.2.2	Mapping of the Packet Timing Advance Control Channel (PTCCH/U) .....	50
6.3.2.2.3	Mapping of the uplink PCCCH i.e. PRACH .....	50
6.3.2.2.3a	Mapping of the COMPACT uplink CPCCCH i.e. CPRACH.....	50

6.3.2.2.4	Mapping of the MBMS uplink MPRACH.....	50
6.3.2.2.5	Void.....	50
6.3.2.2.6	Mapping of Overlaid CDMA sub channels.....	50
6.3.2.3	Mapping of the downlink channels.....	51
6.3.2.3.1	Mapping of the (EC-)PDTCH/D and (EC-)PACCH/D.....	51
6.3.2.3.2	Mapping of the PTCCH/D.....	51
6.3.2.3.3	Mapping of the PBCCH.....	52
6.3.2.3.3a	Mapping of the COMPACT CPBCCH.....	52
6.3.2.3.3b	Void.....	52
6.3.2.3.4	Mapping of the PCCCH.....	52
6.3.2.3.4a	Mapping of the COMPACT CPCCCH.....	52
6.3.2.3.4b	Void.....	53
6.3.2.4	Mapping of PBCCH data.....	53
6.3.2.4a	Mapping of COMPACT CPBCCH data.....	53
6.3.2.4b	Void.....	54
6.3.3	Mapping in time of CTS control channels onto physical channels.....	54
6.3.3.1	CTS BCH timeslot assignment.....	54
6.3.3.2	CTSPCH, CTSARCH and CTSAGCH timeslot assignment.....	55
6.3.4	Mapping in time of Extended Coverage control channels onto physical channels.....	56
6.3.4.1	General.....	56
6.3.4.2	Mapping of the downlink Extended Coverage CCCH (EC-CCCH/D).....	56
6.3.4.3	Mapping of the uplink Extended Coverage CCCH (EC-CCCH/U).....	56
6.3.4.4	Mapping of EC-BCCH data.....	56
6.4	Permitted channel combinations.....	57
6.4.1	Permitted channel combinations onto a basic physical channel.....	57
6.4.2	Multislot configurations.....	61
6.4.2.1	General.....	61
6.4.2.1	Multislot configurations for circuit switched connections in <i>A/Gb mode</i> .....	61
6.4.2.2	Multislot configurations for packet switched connections in <i>A/Gb mode</i> .....	62
6.4.2.3	Multislot configurations for dual transfer mode in <i>A/Gb mode</i> .....	65
6.4.2.3a	Multislot configurations for MBMS in <i>A/Gb mode</i> .....	66
6.4.2.4	Multislot configurations for DBPSCH in <i>Iu mode</i> .....	67
6.4.2.4.1	TCHs assigned.....	67
6.4.2.4.2	PDTCHs assigned.....	67
6.4.2.4.3	TCHs and PDTCHs assigned.....	67
6.4.2.5	void.....	67
6.4.2.6	Multislot configurations for SBPSCH in <i>Iu mode</i> .....	67
6.4.2.7	Multislot configurations for dual transfer mode in <i>Iu mode</i> .....	67
6.5	Operation of channels and channel combinations.....	68
6.5.1	General.....	68
6.5.2	Determination of CCCH_GROUP and PAGING_GROUP for MS in idle mode.....	71
6.5.2a	Determination of CCCH_GROUP, PAGING_GROUP_MF and PAGING_GROUP_PCH for MS in idle mode when using extended DRX cycles.....	71
6.5.2b	Determination of EC_CCCH_GROUP and PAGING_GROUP for MS in idle mode for EC-GSM-IoT.....	72
6.5.3	Determination of specific paging multiframe and paging block index.....	73
6.5.3a	Determination of specific paging multiframe and paging block index for EC-GSM-IoT.....	74
6.5.3a.1	CC1.....	74
6.5.3a.2	CC2.....	74
6.5.3a.3	CC3.....	74
6.5.3a.4	CC4.....	74
6.5.3b	Determination of specific paging multiframe and paging block index when using extended DRX cycles.....	74
6.5.3c	Determination of EC-PICH block for EC-GSM-IoT.....	75
6.5.4	Short Message Service Cell Broadcast (SMSCB).....	75
6.5.5	Voice group and voice broadcast call notifications.....	76
6.5.6	Determination of PCCCH_GROUP and PAGING_GROUP for MS in GPRS attached mode.....	76
6.5.6a	Determination of extended DRX cycle for MS in GPRS attached mode.....	77
6.5.7	Determination of CTS_PAGING_GROUP and specific paging 52-multiframe for MS in CTS mode.....	77
6.5.8	Determination of single carrier fallback group.....	78
7	Mapping tables.....	79

8	Flexible layer one .....	121
8.1	General .....	121
8.2	Transport channels .....	121
8.3	Mapping of transport channels onto physical channels .....	121
8.3.1	General .....	121
8.3.2	Mapping in frequency of transport channels onto physical channels .....	121
8.3.3	Mapping in time of transport channels onto physical channels .....	121
8.3.4	Permitted channel combinations onto a basic physical subchannel .....	124
8.3.5	Multislot configurations .....	125
8.3.5.1	Multislot configurations for DBPSCHs assigned .....	125
8.3.5.2	Multislot configurations for dual transfer mode in Iu mode .....	125
<b>Annex A (normative): Phase 2 mobiles in a Phase 1 infrastructure .....</b>		<b>126</b>
A.1	Scope .....	126
A.2	Implementation options for TCH channels .....	126
A.2.1	C0 filling on the TCH .....	126
A.2.1.1	A dummy burst with (BN61, BN62, BN86) = training sequence bits of normal bursts .....	126
A.2.1.2	A dummy burst with the "C0 filling training sequence .....	126
A.2.1.3	A dummy burst with ( BN61, BN62, BN86) mapped from the TSC bits of normal bursts according to the table .....	126
A.2.1.4	Partial SID information .....	126
A.2.2	Half burst filling .....	126
A.2.2.1	Partial SID information from any associated SID frame; or .....	127
A.2.2.2	The mixed bits of the dummy bursts (encrypted or not encrypted) .....	127
A.2.3	Dummy burst Stealing flag .....	127
A.2.4	Half burst Filling Stealing flag .....	127
A.2.5	Allowed combinations .....	127
A.3	Idle Channels .....	127
<b>Annex B (normative): Multislot capability .....</b>		<b>128</b>
B.1	MS classes for multislot capability .....	128
B.2	Constraints imposed by the service selected .....	131
B.3	Network requirements for supporting MS multislot classes .....	131
B.4	Multislot capabilities for dual carrier mobile stations .....	133
B.5	Multislot capabilities when EFTA is used .....	135
B.6	Multislot capabilities for Downlink Multi Carrier mobile stations .....	136
<b>Annex C (informative): CTSBCH Timeslot shifting example .....</b>		<b>137</b>
<b>Annex D (informative): COMPACT multiframe structure examples .....</b>		<b>138</b>
<b>Annex E (informative): Example illustrations of neighbour cell measurements for downlink dual carrier MS .....</b>		<b>146</b>
<b>Annex F (informative): Illustration of mapping restrictions in Downlink Multi Carrier .....</b>		<b>147</b>
<b>Annex G (informative): Change history .....</b>		<b>150</b>
History .....		155

---

# Foreword

This Technical Specification has been produced by the 3<sup>rd</sup> Generation Partnership Project (3GPP).

The contents of the present document are subject to continuing work within the TSG and may change following formal TSG approval. Should the TSG modify the contents of the present document, it will be re-released by the TSG with an identifying change of release date and an increase in version number as follows:

Version x.y.z

where:

- x the first digit:
  - 1 presented to TSG for information;
  - 2 presented to TSG for approval;
  - 3 or greater indicates TSG approved document under change control.
- y the second digit is incremented for all changes of substance, i.e. technical enhancements, corrections, updates, etc.
- z the third digit is incremented when editorial only changes have been incorporated in the document.



---

# 1 Scope

The present document defines the physical channels of the radio sub-system required to support the logical channels. For the Flexible Layer One, it defines the physical channels of the radio sub-system required to support the transport channels. It includes a description of the logical channels, transport channels and the definition of frequency hopping, TDMA frames, timeslots and bursts.

## 1.1 References

The following documents contain provisions which, through reference in this text, constitute provisions of the present document.

- References are either specific (identified by date of publication, edition number, version number, etc.) or non-specific.
- For a specific reference, subsequent revisions do not apply.
- For a non-specific reference, the latest version applies. In the case of a reference to a 3GPP document (including a GSM document), a non-specific reference implicitly refers to the latest version of that document *in the same Release as the present document*.

- [1] 3GPP TR 21.905: "Vocabulary for 3GPP Specifications".
- [2] 3GPP TS 23.003: "Numbering, addressing and identification".
- [3] 3GPP TS 23.034: "High Speed Circuit Switched Data (HSCSD) – Stage 2".
- [4] 3GPP TS 43.052: "GSM Cordless Telephony System (CTS), Phase 1; Lower layers of the CTS Radio Interface; Stage 2".
- [5] 3GPP TS 43.059: "Functional stage 2 description of Location Services (LCS) in GERAN".
- [6] 3GPP TS 43.064: "General Packet Radio Service (GPRS); Overall description of the GPRS Radio Interface; Stage 2".
- [7] 3GPP TS 43.246: "Multimedia Broadcast Multicast Service (MBMS) in the GERAN; Stage 2".
- [8] 3GPP TS 44.003: "Mobile Station - Base Station System (MS - BSS) interface Channel structures and access capabilities".
- [9] 3GPP TS 44.006: "Mobile Station - Base Station System (MS - BSS) interface Data Link (DL) layer specification".
- [10] 3GPP TS 44.018: "Mobile radio interface layer 3 specification, Radio Resource Control Protocol".
- [11] 3GPP TS 44.060: "General Packet Radio Service (GPRS); Mobile Station (MS) - Base Station System (BSS) interface; Radio Link Control (RLC) and Medium Access Control (MAC) Layer Specification".
- [12] 3GPP TS 44.056: "GSM Cordless Telephony System (CTS), Phase 1; CTS radio interface layer 3 specification".
- [13] 3GPP TS 45.003: "Channel coding".
- [14] 3GPP TS 45.004: "Modulation".
- [15] 3GPP TS 45.005: "Radio transmission and reception".
- [16] 3GPP TS 45.008: "Radio subsystem link control".
- [17] 3GPP TS 45.010: "Radio subsystem synchronization".
- [18] 3GPP TS 45.056: "GSM Cordless Telephony System (CTS), Phase 1; CTS-FP radio subsystem".

- [19] 3GPP TR 45.902: "Flexible Layer One".
- [20] 3GPP TS 46.031: "Discontinuous Transmission (DTX) for full rate speech traffic channels".
- [21] 3GPP TS 24.008: "Mobile Radio Interface Layer 3 specification; Core Network Protocols - Stage 3".
- [22] 3GPP TS 23.060: "General Packet Radio Service (GPRS); Service Description; Stage 2".

## 1.2 Abbreviations

Abbreviations used in the present document are listed in 3GPP TR 21.905 [1]. In addition to abbreviations in 3GPP TR 21.905 [1], the following abbreviations are applied:

BTTI	Basic Transmission Time Interval
EDAB	Extended Dual slot Access Burst
ESAB	Extended Synchronization Access Burst
FANR	Fast Ack/Nack Reporting
RTTI	Reduced Transmission Time Interval
TTI	Transmission Time Interval

### 1.2a Definitions

**Coverage Class:** see definition in 3GPP TS 43.064 [6].

**EC-GSM-IoT:** see definition in 3GPP TS 43.064 [6].

**EC operation:** see definition in 3GPP TS 43.064 [6].

## 1.3 Restrictions

Independently of what is stated elsewhere in this and other 3GPP specifications, mobile station support for PBCCH and PCCCH is optional for A/Gb-mode of operation. The network shall never enable PBCCH and PCCCH.

---

# 2 General

The radio subsystem is required to support a certain number of logical channels that can be separated into two categories as defined in 3GPP TS 44.003:

- i) the traffic channels (TCH's);
- ii) the control channels.

More information is given about these logical channels in clause 3 which also defines a number of special channels used by the radio sub-system.

Clause 4 of this document describes the physical resource available to the radio sub-system, clause 5 defines physical channels based on that resource and clause 6 specifies how the logical channels shall be mapped onto physical channels. Figure 1 depicts this process.

With the Flexible Layer One (FLO), the radio subsystem is required to support transport channels (see 3GPP TR 45.902). Clause 8 of this document describes the mapping and multiplexing principles that are specific to FLO. Because FLO offers transport channels instead of logical channels, any reference to logical channels, with the exception of SACCH, does not apply to FLO. Otherwise, and unless otherwise stated, the multiplexing principles described in this document are equally applicable to FLO (e.g. physical resource and physical channels).

---

## 3 Logical channels

### 3.1 General

This subclause describes the logical channels that are supported by the radio subsystem.

### 3.2 Traffic channels

#### 3.2.1 General

Traffic channels (TCH's) are intended to carry either encoded speech or user data in circuit switched mode. Five general forms of traffic channel are defined:

- i) Full rate traffic channel (TCH/F). This channel carries information at a gross rate of 22,8 kbit/s.
- ii) Half rate traffic channel (TCH/H). This channel carries information at a gross rate of 11,4 kbit/s.
- iii) Enhanced circuit switched full rate traffic channel (E-TCH/F). This channel carries information at a gross rate of 69,6 kbit/s including the stealing symbols.
- iv) 8-PSK full rate traffic channel (O-TCH/F). This channel carries information at a gross rate of 68,4 kbit/s.
- v) 8-PSK half rate traffic channel (O-TCH/H). This channel carries information at a gross rate of 34,2 kbit/s.

Packet data traffic channels (PDTCH's) are intended to carry user data in packet switched mode. For the purpose of this Technical Specification, any reference to traffic channel does not apply to PDTCH unless explicitly stated.

All traffic channels are bi-directional unless otherwise stated. Unidirectional downlink full rate channels, TCH/FD, are defined as the downlink part of the corresponding TCH/F.

Multiple full rate channels can be assigned to the same MS. This is referred to as multislot configurations, which is defined in subclause 6.4.2.1.

Multiple packet data traffic channels can be assigned to the same MS or, in the case of point-to-multipoint transmission, a group of MSs. This is referred to as multislot packet configurations, as defined in subclause 6.4.2.2 and subclause 6.4.2.3a.

A combination of a half rate traffic channel and a half rate packet data traffic channel on the same basic physical channel can be assigned to the same MS as defined in subclause 6.4.2.3.

A combination of a traffic channel and one or more full rate packet data traffic channels can be assigned to the same MS.

A pair of speech traffic channels along with their associated control channels sharing the same timeslot number (see subclause 4.3), ARFCN (see subclause 6.2.3) and TDMA frame number (see subclause 4.3) is referred to as a *VAMOS pair*. The speech traffic channels along with their associated control channels in a *VAMOS pair* are said to be in *VAMOS mode* and are referred to as *VAMOS subchannels*.

In case of speech traffic channels in *VAMOS mode*, up to 4 speech traffic channels can be mapped on the same basic physical channel both in downlink and uplink (see subclause 6.4.1).

The specific traffic channels available in the categories of speech and user data are defined in the subclauses following.

#### 3.2.2 Speech traffic channels

The following traffic channels are defined to carry encoded speech:

- i) full rate traffic channel for speech (TCH/FS);
- ii) half rate traffic channel for speech (TCH/HS);

- iii) enhanced full rate traffic channel for speech (TCH/EFS);
- iv) adaptive full rate traffic channel for speech (TCH/AFS);
- v) adaptive half rate traffic channel for speech (TCH/AHS);
- vi) adaptive full rate traffic channel for wideband speech (TCH/WFS);
- vii) adaptive half rate 8PSK traffic channel for speech (O-TCH/AHS);
- viii) adaptive full rate 8PSK traffic channel for wideband speech (O-TCH/WFS);
- ix) adaptive half rate 8PSK traffic channel for wideband speech (O-TCH/WHS).

### 3.2.3 Circuit switched data traffic channels

The following traffic channels are defined to carry user data:

- i) full rate traffic channel for 9,6 kbit/s user data (TCH/F9.6);
- ii) full rate traffic channel for 4,8 kbit/s user data (TCH/F4.8);
- iii) half rate traffic channel for 4,8 kbit/s user data (TCH/H4.8);
- iv) half rate traffic channel for  $\leq 2,4$  kbit/s user data (TCH/H2.4);
- v) full rate traffic channel for  $\leq 2,4$  kbit/s user data (TCH/F2.4);
- vi) full rate traffic channel for 14,4 kbit/s user data (TCH/F14.4);
- vii) enhanced circuit switched full rate traffic channel for 28,8 kbit/s user data (E-TCH/F28.8);
- viii) enhanced circuit switched full rate traffic channel for 32,0 kbit/s user data (E-TCH/F32.0);
- ix) enhanced circuit switched full rate traffic channel for 43.2 kbit/s user data (E-TCH/F43.2).

### 3.2.4 Packet data traffic channels (PDTCH and EC-PDTCH)

A PDTCH/F corresponds to the resource assigned to a single MS or, in the case of point-to-multipoint transmission, to multiple MSs for user data transmission. An EC-PDTCH/F always corresponds to the resource assigned to a single MS in BTTI configuration.

In BTTI configuration, an (EC-)PDTCH/F is mapped onto one physical channel (see subclause 6.3.2.1). Due to the dynamic multiplexing onto the same physical channel of different logical channels (see subclause 6.3.2), an (EC-)PDTCH/F in BTTI configuration carries information at an instantaneous bit rate ranging from 0 to a maximum value dependent on the modulation and on the symbol rate, as given in table 3.2.4-1.

**Table 3.2.4-1: Maximum instantaneous bit rate (kbit/s) for different modulations**

Modulation	Maximum instantaneous bit rate (kbit/s)	
	Normal symbol rate <sup>1</sup>	Higher symbol rate <sup>1</sup>
GMSK	22,8	-
QPSK	-	55,2
8-PSK	69,6	-
16QAM	92,8	110,4
32QAM	116,0	138,0

NOTE: see 3GPP TS 45.004 [14]

In RTTI configuration, a PDTCH/F is mapped onto two physical channels, i.e. a PDCH-pair (see subclause 6.3.2.1). A PDTCH/F in RTTI configuration carries information at an instantaneous bit rate ranging from 0 to a maximum value which is double the corresponding value for that modulation and the symbol rate.

A PDTCH/H corresponds to the resource assigned to a single MS on half a physical channel for user data transmission. The maximum instantaneous bit rate for a PDTCH/H is half that for a PDTCH/F. A PDTCH/H is only possible in BTTI configuration if FANR is not activated (see 3GPP TS 44.060 [11]).

All packet data traffic channels are uni-directional, either uplink ((EC-)PDTCH/U), for a mobile originated packet transfer or downlink ((EC-)PDTCH/D) for a mobile terminated packet transfer.

In the case of point-to-multipoint transmission, a PDTCH/D can be used for communication with multiple MSs.

## 3.3 Control channels

### 3.3.1 General

Control channels are intended to carry signalling or synchronization data. Four categories of control channel are defined: broadcast, common, dedicated and CTS control channels. Specific channels within these categories are defined in the subclauses following.

### 3.3.2 Broadcast channels

#### 3.3.2.1 Frequency correction channels (FCCH and CFCCCH)

The frequency correction channel carries information for frequency correction of the mobile station. It is required only for the operation of the radio sub-system. Different mapping is used for FCCH and COMPACT CFCCCH (see clause 7).

#### 3.3.2.2 Synchronization channels

##### 3.3.2.2.0 General

The synchronization channel carries information for frame synchronization of the mobile station and identification of a base transceiver station. It is required only for the operation of the radio sub-system. Different channels are used for SCH, EC-SCH and COMPACT CSCH.

##### 3.3.2.2.1 Synchronization channel (SCH)

Specifically the synchronization channel (SCH) shall contain two encoded parameters:

- a) Base transceiver station identity code (BSIC): 6 bits (before channel coding) consists of 3 bits of PLMN colour code with range 0 to 7 and 3 bits of BS colour code with range 0 to 7 as defined in 3GPP TS 23.003 [2].
- b) Reduced TDMA frame number (RFN): 19 bits (before channel coding) =

T1 (11 bits) range 0 to 2047 =  $FN \text{ div } (26 \times 51)$

T2 (5 bits) range 0 to 25 =  $FN \text{ mod } 26$

T3' (3 bits) range 0 to 4 =  $(T3 - 1) \text{ div } 10$

where

T3 (6 bits) range 0 to 50 =  $FN \text{ mod } 51$

and

FN = TDMA frame number as defined in subclause 4.3.3.

3GPP TS 44.006 [9] and 3GPP TS 44.018 [10] specify the precise bit ordering, 3GPP TS 45.003 [13] the channel coding of the above parameters and 3GPP TS 45.010 [17] defines how the TDMA frame number can be calculated from T1, T2, and T3'.

##### 3.3.2.2.2 COMPACT synchronization channel (CSCH)

The COMPACT packet synchronization channel CSCH shall contain two encoded parameters:

- a) Base transceiver station identity code (BSIC): 6 bits (before channel coding) consists of 3 bits of PLMN colour code with range 0 to 7 and 3 bits BS colour code with range 0 to 7 as defined in 3GPP TS 23.003 [2].

b) Reduced TDMA frame number (RFN): 19 bits (before channel coding) =

R1 (10 bits) range 0 to 1023 =  $\text{FN div } (51 \times 52)$

R2 (6 bits) range 0 to 50 =  $(\text{FN div } 52) \bmod 51$

TG(2 bits) range 0 to 3

Reserved (1 bit)

where

FN = TDMA frame number as defined in subclause 4.3.3

and

TG = time group as defined in subclause 4.3.4.

3GPP TS 44.006 [9] and 3GPP TS 44.018 [10] specify the precise bit ordering, 3GPP TS 45.003 [13] the channel coding of the above parameters and 3GPP TS 45.010 [17] defines how the TDMA frame number can be calculated from R1 and R2.

### 3.3.2.2.3 Extended Coverage synchronization channel (EC-SCH)

The extended coverage synchronization channel (EC-SCH) shall contain six encoded parameters, and three spare bits:

a) Base transceiver station identity code (BSIC): 9 bits (before channel coding) consists of 3 bits of PLMN colour code with range 0 to 7, 3 bits of BS colour code with range 0 to 7 and 3 bits of Radio frequency Colour Code with range 0 to 7 as defined in 3GPP TS 23.003 [2].

b) Parameters used to identify the Reduced TDMA frame number per quarter hyperframe ( $\text{RFN}_{\text{QH}}$ ): 12 bits (before channel coding) =

T1'(8 bits) range 0 to 255 =  $(\text{FN div } (51 \times 26 \times 2)) \bmod 256$

NOTE 1: T1' identifies one of 256 pairs of superframes within a quarter hyperframe

T2'(4 bits) range 0 to 12 =  $(\text{FN div } (51 \times 4)) \bmod 13$

NOTE 2: T2' identifies a specific set of four contiguous 51-multiframes within a pair of superframes, i.e. 52 51-multiframes.

c) Implicit Reject Status: 2 bits

See 3GPP TS 44.018 [10].

d) EC-BCCH CHANGE MARK: 3 bits

See 3GPP TS 44.018 [10].

NOTE 2a: Indicating a new value for the EC-BCCH CHANGE MARK in the EC-SCH shall start within the same 51-multiframe used to begin the transmission of the corresponding new EC SI information.

e) RACH Access Control: 1 bit

See 3GPP TS 44.018 [10].

In addition, the following parameters are required to derive the Reduced frame number per quarter hyperframe ( $\text{RFN}_{\text{QH}}$ ):

f) T2'' (2 bits) range 0 to 3 =  $(\text{FN div } 51) \bmod 4$

NOTE 3: T2'' identifies the specific 51-multiframe in the set of four contiguous 51-multiframes. T2'' is signalled through the cyclic shift pattern used on the EC-SCH, see 3GPP TS 45.003 [13].

g) T3 (see subclause 3.3.2.2.1) will be determined by the device through the identification of the mapping of the FCCH onto the specific TDMA frames within the 51-multiframe, see Table 3.

After the decoding of EC-SCH and the determination of T3, the MS will have knowledge about the frame structure within a quarter hyperframe. The QUARTER\_HYPERFRAME\_INDICATOR is acquired when receiving an Immediate Assignment, see 3GPP TS 44.018 [10].

QUARTER\_HYPERFRAME\_INDICATOR (2 bits) range 0...3 = FN div (26\*51\*512)

After acquisition of the QUARTER\_HYPERFRAME\_INDICATOR, the MS will have knowledge about the frame structure within a hyperframe.

3GPP TS 44.006 [9] and 3GPP TS 44.018 [10] specify the precise bit ordering, 3GPP TS 45.003 [13] the channel coding of the above parameters and 3GPP TS 45.010 [17] defines how the TDMA frame number (FN as defined in subclause 4.3.3) can be calculated from T1', T2', T2'', T3 and the QUARTER\_HYPERFRAME\_INDICATOR.

### 3.3.2.3 Broadcast control channel (BCCH)

The broadcast control channel broadcasts general information on a base transceiver station per base transceiver station basis. Of the many parameters contained in the BCCH, the use of the following parameters, as defined in 3GPP TS 44.018 are referred to in subclause 6.5:

- a) CCCH\_CONF which indicates the organization of the common control channels:

From this parameter, the number of common control channels (BS\_CC\_CHANS) and whether or not CCCH or SDCCH are combined (BS\_CCCH\_SDCCH\_COMB = true or false) are derived as follows:

CCCH_CONF	BS_CC_CHANS	BS_CCCH_SDCCH_COMB
000	1	false
001	1	true
010	2	false
100	3	false
110	4	false

- b) BS\_AG\_BLK\_RES which indicates the number of blocks on each common control channel reserved for access grant messages:

3 bits (before channel coding) range 0 to 7.

In a routing area where eDRX is supported, the number of blocks per 51-multiframe reserved for AGCH is subject to the requirement that all cells in the routing area shall have the same number of paging blocks per 51-multiframe.

- c) BS\_PA\_MFRMS which indicates the number of 51-multiframes between transmission of paging messages to mobiles of the same paging group:

3 bits (before channel coding) range 2 to 9.

An exception is the case where a MS has negotiated the use of eDRX in a Routing Area where eDRX is supported (see 3GPP TS 44.018 [10]) in which case the BS\_PA\_MFRMS does not apply. In this case the number of 51-multiframes between transmissions of paging messages is based on the eDRX value negotiated between the MS and the network - see Table 6.5.6a-1.

- d) support of GPRS

The BCCH shall indicate whether or not packet switched traffic is supported. If packet switched traffic is supported and if the PBCCH exists, then the BCCH shall broadcast the position of the packet data channel (PDCH), as defined in subclause 6.3.2.1, carrying the PBCCH. (See sub-clause 1.3).

#### 3.3.2.3a Extended coverage broadcast control channel (EC-BCCH)

The extended coverage broadcast control channel broadcasts general information on a base transceiver station per base transceiver station basis. Of the many parameters contained in the EC-BCCH, the use of the following parameter, as defined in 3GPP TS 44.018 [10] is referred to in subclause 6.5:

- a) EC\_BS\_CC\_CHANS which indicates the number of extended coverage common control channels.

### 3.3.2.4 Packet Broadcast Control Channels

#### 3.3.2.4.1 Packet Broadcast Control Channel (PBCCH)

The PBCCH broadcasts parameters used by the MS to access the network for packet transmission operation. In addition to those parameters the PBCCH reproduces the information transmitted on the BCCH to allow circuit switched operation, such that a MS in GPRS attached mode monitors the PBCCH only, if it exists. The existence of the PBCCH in the cell is indicated on the BCCH. (See sub-clause 1.3). In the absence of PBCCH, the BCCH shall be used to broadcast information for packet operation.

Of the many parameters contained in the PBCCH, the use of the following parameters, as defined in 3GPP TS 44.060 are referred to in subclauses 6.5 and 6.3.2:

- a) BS\_PBCCH\_BLKs (1,...,4) indicates the number of blocks allocated to the PBCCH in the multiframe (see subclause 6.3.2.3.3).
- b) BS\_PCC\_CHANS indicates the number of physical channels carrying PCCCHs including the physical channel carrying the PBCCH
- c) BS\_PAG\_BLKs\_RES indicates the number of blocks on each PDCH carrying PCCCH per multiframe where neither PPCH nor PBCCH should appear (see subclause 6.3.2.3.4). The BS\_PAG\_BLKs\_RES value shall fulfil the condition :  $BS\_PAG\_BLKS\_RES \leq 12 - BS\_PBCCH\_BLKS - 1$ .
- d) BS\_PRACH\_BLKs indicates the number of blocks reserved in a fixed way to the PRACH channel on any PDCH carrying PCCCH (see subclause 6.3.2.2.3).

The PBCCH channel of a cell shall be allocated on the same frequency band (see 3GPP TS 45.005) as the BCCH channel of that cell.

#### 3.3.2.4.2 COMPACT Packet Broadcast Control Channel (CPBCCH)

The CPBCCH is a stand-alone packet control channel for COMPACT. The CPBCCH broadcasts parameters used by the MS to access the network for packet transmission operation.

Of the many parameters contained in the CPBCCH, the use of the following parameters, as defined in 3GPP TS 44.060 are referred to in subclauses 6.5 and 6.3.3:

- a) BS\_PBCCH\_BLKs (1,...,4) indicates the number of blocks allocated to the CPBCCH in the multiframe (see subclause 6.3.2.3.3a).
- b) BS\_PCC\_CHANS indicates the number of radio frequency channels per cell carrying CPCCCHs including the radio frequency channel carrying the CPBCCH.
- c) BS\_PAG\_BLKs\_RES indicates the number of blocks on each radio frequency channel carrying CPCCCH per multiframe where neither CPPCH nor CPBCCH should appear (see subclause 6.3.2.3.4a). BS\_PAG\_BLKs\_RES cannot be greater than 8.
- d) BS\_PRACH\_BLKs indicates the number of blocks reserved in a fixed way to the CPRACH channel on any radio frequency channel carrying CPCCCH (see subclause 6.3.2.2.3a).
- e) NIB\_CCCH\_0, NIB\_CCCH\_1, NIB\_CCCH\_2, and NIB\_CCCH\_3 indicate the number of downlink blocks per multiframe designated as idle to protect CPBCCH and CPCCCH blocks for non-serving time groups (see subclause 6.5.1).
- f) LARGE\_CELL\_OP indicates which type of cell size is used: nominal or large.



### 3.3.3 Common control type channels

#### 3.3.3.1 Common control type channels, known when combined as a common control channel (CCCH)

- i) Paging channel (PCH): Downlink only, used to page mobiles.
- ii) Random access channel (RACH): Uplink only, used to request assignment of a SDCCH or to request assignment of one or several (EC-)PDTCHs.
- iii) Access grant channel (AGCH): Downlink only, used to assign a SDCCH or directly a TCH. Also used to assign one or several (EC-)PDTCHs.
- iv) Notification channel (NCH): Downlink only, used to notify mobile stations of voice group and voice broadcast calls.

#### 3.3.3.2 Packet Common control channels

##### 3.3.3.2.1 Packet Common Control Channels (PCCCH)

- i) Packet Paging channel (PPCH): Downlink only, used to page MS.
- ii) Packet Random access channel (PRACH): Uplink only, used to request assignment of one or several PDTCHs (for uplink or downlink direction).
- iii) Packet Access grant channel (PAGCH): Downlink only, used to assign one or several PDTCH.

If a PCCCH is not allocated, the information for packet switched operation is transmitted on the CCCH. If a PCCCH is allocated, it may transmit information for circuit switched operation. (See sub-clause 1.3).

The PCCCH channel of a cell shall be allocated on the same frequency band (see 3GPP TS 45.005 [15]) as the BCCH channel of that cell.

##### 3.3.3.2.2 COMPACT Common Control Channels (CPCCCH)

- i) Packet Paging channel (CPPCH): Downlink only, used to page MS.
- ii) Packet Random access channel (CPRACH): Uplink only, used to request assignment of one or several PDTCHs (for uplink or downlink direction).
- iii) Packet Access grant channel (CPAGCH): Downlink only, used to assign one or several PDTCH.

##### 3.3.3.2.3 MBMS Common Control Channels

- i) MBMS Packet Random access channel (MPRACH): Uplink only, used during the initial counting procedure for MBMS (see 3GPP TS 44.060).

#### 3.3.3.3 Extended Coverage Common Control Channels

- i) Extended Coverage Paging channel (EC-PCH): Downlink only, used to page MS.
- ii) Extended Coverage Random access channel (EC-RACH): Uplink only, used to request assignment of one or several EC-PDTCH's (for uplink direction).
- iii) Extended Coverage Access grant channel (EC-AGCH): Downlink only, used to assign one or several EC-PDTCH's.

### 3.3.4 Dedicated control channels

#### 3.3.4.1 Circuit switched dedicated control channels

- i) Slow, TCH/F or E-TCH/F associated, control channel (SACCH/TF).
- ii) Fast, TCH/F associated, control channel (FACCH/F).
- iii) Slow, TCH/H or O-TCH/H associated, control channel (SACCH/TH).
- iv) Fast, TCH/H associated, control channel (FACCH/H).
- v) Stand alone dedicated control channel (SDCCH/8).
- vi) Slow, SDCCH/8 associated, control channel (SACCH/C8)
- vii) Stand alone dedicated control channel, combined with CCCH (SDCCH/4).
- viii) Slow, SDCCH/4 associated, control channel (SACCH/C4).
- ix) slow, TCH/F, O-TCH/F or E-TCH/F associated, control channel for multislot configurations (SACCH/M).
- x) slow, TCH/F associated, control channel for CTS (SACCH/CTS).
- xi) Fast, E-TCH/F associated, control channel (E-FACCH/F).
- xii) Inband, E-TCH/F associated, control channel (E-IACCH/F).
- xiii) Slow, TCH/F or O-TCH/F associated, control channel for enhanced power control (SACCH/TPF).
- xiv) Slow, TCH/F or O-TCH/F associated, control channel for enhanced power control in multislot configurations (SACCH/MP).
- xv) Slow, TCH/H or O-TCH/H associated, control channel for enhanced power control (SACCH/TPH).
- xvi) Enhanced power control, TCH/F or O-TCH/F associated channel (EPCCH/F).
- xvii) Enhanced power control, TCH/F or O-TCH/F associated channel in multislot configurations (EPCCH/M).
- xviii) Enhanced power control, TCH/H or O-TCH/H associated channel (EPCCH/H);
- xix) Fast, O-TCH/H associated, control channel (O-FACCH/H);
- xx) Fast, O-TCH/F associated, control channel (O-FACCH/F).

All associated control channels have the same direction (bi-directional or unidirectional) as the channels they are associated to. The unidirectional SACCH/MD, SACCH/MPD and EPCCH/MD are defined as the downlink part of SACCH/M, SACCH/MP and EPCCH/M respectively.

#### 3.3.4.2 Packet dedicated control channels

- i) The Packet Associated Control channel (PACCH): The PACCH is bi-directional. For description purposes PACCH/U is used for the uplink and PACCH/D for the downlink. The PACCH shall be transmitted using the same configuration (BTTI or RTTI) of the PDTCH that it is associated with.
- ii) Packet Timing advance control channel uplink (PTCCH/U): Used to transmit random access bursts to allow estimation of the timing advance for one MS in packet transfer mode.
- iii) Packet Timing advance control channel downlink (PTCCH/D): Used to transmit timing advance updates for several MS. One PTCCH/D is paired with several PTCCH/U's.

#### 3.3.4.3 Extended Coverage Packet dedicated control channels

- i) The Extended Coverage Packet Associated Control channel (EC-PACCH): The EC-PACCH is bi-directional. For description purposes EC-PACCH/U is used for the uplink and EC-PACCH/D for the downlink. Both the

EC-PACCH and EC-PDTCH shall be transmitted using the Coverage Class of the direction they are transmitted in. The Coverage Class need not be the same on uplink and downlink.

### 3.3.5 Cell Broadcast Channel (CBCH)

The CBCH, downlink only, is used to carry the short message service cell broadcast (SMS-CB). The CBCH uses the same physical channel as the SDCCH.

### 3.3.6 CTS control channels

Four types of CTS control channels are defined:

#### 3.3.6.1 CTS beacon channel (BCH)

The BCH is used to provide frequency and synchronization information in the downlink. It is made up of a pair of CTSBCH-SB (Synchronization burst) and CTSBCH-FB (Frequency correction burst).

The CTSBCH-FB carries information for frequency correction of the mobile station. It is required only for the operation of the radio sub-system.

The CTSBCH-SB carries signalling information and identification of a CTS-FP. Specifically the CTSBCH-SB shall contain five encoded parameters:

- a) status of the CTS-FP radio resources : 1 bit (before channel coding);
- b) flag indicating the presence of CTSPCH in the next 52-multiframe : 1 bit (before channel coding);
- c) flag indicating whether the CTS-FP is currently performing timeslot shifting on CTSBCH: 1 bit (before channel coding);
- d) CTS control channels (except CTSBCH) timeslot number for the next 52-multiframe (TNC): 3 bits (before channel coding);
- e) CTS-FP beacon identity (FPBI) : 19 bits (before channel coding), as defined in 3GPP TS 23.003.

3GPP TS 44.056 specifies the precise bit ordering and 3GPP TS 45.003 the channel coding of the above parameters.

#### 3.3.6.2 CTS paging channel (CTSPCH)

Downlink only, used to broadcast information for paging.

#### 3.3.6.3 CTS access request channel (CTSARCH)

Uplink only, used to request assignment of a dedicated RR connection.

#### 3.3.6.4 CTS access grant channel (CTSAGCH)

Downlink only, used to grant a dedicated RR connection.

## 3.4 Combination of channels

Only certain combinations of channels are allowed as defined in 3GPP TS 44.003. Subclause 6.4 lists the combinations in relation to basic physical channels.

---

## 4 The physical resource

### 4.1 General

The physical resource available to the radio sub-system is an allocation of part of the radio spectrum. This resource is partitioned both in frequency and time. Frequency is partitioned by radio frequency channels (RFCHs) divided into bands as defined in 3GPP TS 45.005. Time is partitioned by timeslots, TDMA frames, and (for COMPACT) time groups and 52-multiframe number as defined in subclause 4.3 of this Technical Specification.

### 4.2 Radio frequency channels

#### 4.2.1 Cell allocation and mobile allocation

3GPP TS 45.005 defines radio frequency channels (RFCHs), and allocates numbers to all the radio frequency channels available to the system. Each cell is allocated a subset of these channels, defined as the cell allocation (CA). One radio frequency channel of the cell allocation shall be used to carry synchronization information and the BCCH, this shall be known as BCCH carrier. The subset of the cell allocation, allocated to a particular mobile, shall be known as the mobile allocation (MA).

For COMPACT, one radio frequency channel of the cell allocation shall be used to carry synchronization information and the CPBCCH, this shall be known as the primary COMPACT carrier. All other radio frequency channels of the cell allocation shall be known as secondary COMPACT carriers.

#### 4.2.2 Downlink and uplink

The downlink comprises radio frequency channels used in the base transceiver station to Mobile Station direction.

The uplink comprises radio frequency channels used in the mobile station to base transceiver station direction.

## 4.3 Timeslots, TDMA frames, and time groups

### 4.3.1 General

A timeslot shall have a duration of  $\frac{3}{5} 200$  seconds ( $\approx 577 \mu\text{s}$ ). Eight timeslots shall form a TDMA frame ( $\approx 4,62$  ms in duration).

At the base transceiver station the TDMA frames on all of the radio frequency channels in the downlink shall be aligned. The same shall apply to the uplink (see 3GPP TS 45.010).

At the base transceiver station the start of a TDMA frame on the uplink is delayed by the fixed period of 3 timeslots from the start of the TDMA frame on the downlink (see figure 2).

At the mobile station this delay will be variable to allow adjustment for signal propagation delay. The process of adjusting this advance is known as adaptive frame alignment and is detailed in 3GPP TS 45.010.

The staggering of TDMA frames used in the downlink and uplink is in order to allow the same timeslot number to be used in the downlink and uplink whilst avoiding the requirement for the mobile station to transmit and receive simultaneously. The period includes time for adaptive frame alignment, transceiver tuning and receive/transmit switching (see figure 4).

### 4.3.2 Timeslot number

The timeslots within a TDMA frame shall be numbered from 0 to 7 and a particular timeslot shall be referred to by its timeslot number (TN).

### 4.3.3 TDMA frame number

TDMA frames shall be numbered by a frame number (FN). The frame number shall be cyclic and shall have a range of 0 to FN\_MAX where FN\_MAX =  $(26 \times 51 \times 2048) - 1 = 2715647$  as defined in 3GPP TS 45.010. For COMPACT, FN\_MAX =  $(52 \times 51 \times 1024) - 1 = 2715647$ . The frame number shall be incremented at the end of each TDMA frame.

The complete cycle of TDMA frame numbers from 0 to FN\_MAX is defined as a hyperframe. A hyperframe consists of 2048 superframes where a superframe is defined as 26 x 51 TDMA frames. For COMPACT, a hyperframe consists of 1024 superframes where a superframe is defined as 52 x 51 TDMA frames. A 26-multiframe, comprising 26 TDMA frames, is used to support traffic and associated control channels and a 51-multiframe, comprising 51 TDMA frames, is used to support broadcast, common control and stand alone dedicated control (and their associated control) channels. Hence a superframe may be considered as 51 traffic/associated control multiframes or 26 broadcast/common control multiframes. A 52-multiframe, comprising two 26-multiframes, is used to support packet data traffic and control channels.

The need for a hyperframe of a substantially longer period than a superframe arises from the requirements of the encryption process which uses FN as an input parameter.

### 4.3.4 Time group

Used for COMPACT, time groups shall be numbered from 0 to 3 and a particular time group shall be referred to by its time group number (TG) (see subclause 3.3.2.2.2). At block B0 and frame number (FN) mod 208 = 0, time group numbers (TG) are associated with timeslot numbers (TN) as follows:

TG	TN
0	1
1	3
2	5
3	7

For COMPACT, a cell is assigned one time group number (TG) on a primary COMPACT carrier. This is known as the serving time group. Other cells may be assigned other time groups on the same carrier.

---

## 5 Physical channels

### 5.1 General

A physical channel uses a combination of frequency and time division multiplexing and is defined as a sequence of radio frequency channels and time slots. The complete definition of a particular physical channel consists of a description in the frequency domain, and a description in the time domain.

The description in the frequency domain is addressed in subclause 5.4; the description in the time domain is addressed in subclause 5.5.

### 5.2 Bursts

#### 5.2.1 General

A burst is a period of RF carrier which is modulated by a data stream. A burst therefore represents the physical content of a timeslot except for the case of ESAB (see sub-clause 5.2.10) which represents the physical content of 2 consecutive timeslots.

#### 5.2.2 Types of burst and burst timing

A timeslot is divided into 156,25 normal symbol periods or 187,5 reduced symbol periods (see 3GPP TS 45.010). For normal symbol period bursts, an integral symbol period implementation option with a timeslot length of 157 normal symbol periods on timeslots with  $TN = 0$  and 4, and 156 normal symbol periods on timeslots with  $TN = 1, 2, 3, 5, 6$  and 7 can be used. In this case, the same timeslot length is also used for reduced symbol period bursts, resulting in a timeslot length of 188.4 reduced symbol periods on timeslots with  $TN = 0$  and 4, and 187.2 reduced symbol periods on timeslots with  $TN = 1, 2, 3, 5, 6$  and 7. In case of EC-GSM-IoT, only normal symbol period bursts with the integral symbol period implementation option shall be used.

The modulating rate is assumed to be the normal symbol rate (see 3GPP TS 45.004) unless otherwise stated.

For GMSK modulation (see 3GPP TS 45.004) a symbol is equivalent to a bit. A particular bit period within a timeslot is referenced by a bit number (BN), with the first bit period being numbered 0, and the last (1/4) bit period being numbered 156, in case of non-integer symbol timeslot.

For AQPSK modulation (see 3GPP TS 45.004) one symbol corresponds to a pair of bits mapped as described in 3GPP TS 45.004. Each bit in the bit pair belongs to a different *VAMOS subchannel* in the *VAMOS pair*. A particular bit period within a timeslot is referenced by a bit number (BN), with the first bit being numbered 0, and the last (1/2) bit being numbered 312, in case of non-integer symbol timeslot. The bit pairs are mapped to the symbols as described in 3GPP TS 45.004. The AQPSK modulation is used only at the normal symbol rate and only in the downlink.

For 8PSK modulation (see 3GPP TS 45.004) one symbol corresponds to three bits. A particular bit period within a timeslot is referenced by a bit number (BN), with the first bit being numbered 0, and the last (3/4) bit being numbered 468, in case of non-integer symbol timeslot. The bits are mapped to symbols in ascending order according to 3GPP TS 45.004.

For 16QAM modulation (see 3GPP TS 45.004) one symbol corresponds to four bits. A particular bit period within a timeslot is referenced by a bit number (BN), with the first bit being numbered 0, and the last bit being numbered 624 for normal symbol rate bursts. When the modulating rate is the higher symbol rate, the last bit is numbered 749. The bits are mapped to symbols in ascending order according to 3GPP TS 45.004.

For 32QAM modulation (see 3GPP TS 45.004) one symbol corresponds to five bits. A particular bit period within a timeslot is referenced by a bit number (BN), with the first bit being numbered 0, and the last (1/4) bit being numbered 781, in case of non-integer symbol timeslot for normal symbol rate bursts. When the modulating rate is the higher symbol rate, the last (1/2, in case of uniform timeslot length) bit is numbered 937. The bits are mapped to symbols in ascending order according to 3GPP TS 45.004.

For QPSK modulation (see 3GPP TS 45.004) one symbol corresponds to two bits. A particular bit period within a timeslot is referenced by a bit number (BN), with the first bit being numbered 0, and the last bit being numbered 374. The bits are mapped to symbols in ascending order according to 3GPPTS45.004. QPSK modulation is used only at the higher symbol rate.

In the subclauses following, the transmission timing of a burst within a timeslot is defined in terms of bit number. The bit with the lowest bit number is transmitted first.

Different types of burst exist in the system. One characteristic of a burst is its useful duration. This document, in the subclauses following, defines full bursts of 147 normal symbol periods useful duration, full bursts of 176 reduced symbol periods useful duration (see 3GPP TS 45.010), a short burst of 87 normal symbol periods useful duration (see subclause 5.2.7) and a long burst of 244 normal symbol periods useful duration (see subclause 5.2.10). The useful part of a burst is defined as beginning from half way through symbol number 0. The definition of the useful part of a burst needs to be considered in conjunction with the requirements placed on the phase and amplitude characteristics of a burst as specified in 3GPP TS 45.004 and 45.005.

The period between bursts appearing in successive timeslots is termed the guard period. Subclause 5.2.8 details constraints which relate to the guard period.

## 5.2.3 Normal burst (NB)

### 5.2.3.1 Normal burst for GMSK

**Table 5.2.3-1: Normal burst GMSK**

Bit Number (BN)	Length of field (bits)	Content of field	Definition
0-2	3	Tail bits	see table 5.2.3-2
3-60	58	Encrypted bits (e0 . e57)	see 3GPP TS 45.003
61-86	26	Training sequence bits	see table 5.2.3a-d
87-144	58	Encrypted bits (e58 . e115)	see 3GPP TS 45.003
145-147	3	Tail bits	see table 5.2.3-2
148-155 148-156	8, 8.25, or, 9 <sup>1</sup>	Guard period (bits)	see subclause 5.2.8
NOTE1: 8 or 9 always applies in case of EC-GSM-IoT, see 3GPP TS 45.010			

The "tail bits" are defined as modulating bits with states as shown in table 5.2.3-2.

**Table 5.2.3-2: Tail bits**

Bit number (BN)	Modulating bits
(BN0, BN1, BN2)	(0, 0, 0)
(BN145, BN146, BN147)	(0, 0, 0)

The "training sequence bits" are defined as modulating bits with states as given in one of the TSC sets defined in table 5.2.3a, 5.2.3b, 5.2.3c and 5.2.3d, according to the training sequence code, TSC. The choice of the TSC set from which the training sequence bits are selected is described in 3GPP TS 44.018. For (EC-)BCCH and CCCH, the TSC must be equal to the BCC, as defined in 3GPP TS 23.003 and shall be selected from the TSC Set 1.

For EC-PCH and EC-AGCH, the TSC shall be selected from the TSC Set 1, if the EC-PCH / EC-AGCH block, is designated to MSs in CC1 only, and shall be selected from TSC Set 2 if the EC-PCH / EC-AGCH block, is designated to at least one MS in a higher coverage class (CC2, CC3 or CC4).

In networks supporting E-OTD Location services (see 3GPP TS 43.059), the use of normal bursts on BCCH frequencies with TSC from the TSC Set 2, TSC set 3 or TSC set 4 might degrade E-OTD Location service performance.

**Table 5.2.3a TSC Set 1 - GMSK**

Training Sequence Code (TSC)	Training sequence bits (BN61, BN62, ..., BN86)
0	(0,0,1,0,0,1,0,1,1,1,0,0,0,0,1,0,0,0,1,0,0,1,0,1,1,1)
1	(0,0,1,0,1,1,0,1,1,1,0,1,1,1,1,0,0,0,1,0,1,1,0,1,1,1)
2	(0,1,0,0,0,0,1,1,1,0,1,1,1,0,1,0,0,1,0,0,0,0,1,1,1,0)
3	(0,1,0,0,0,1,1,1,1,0,1,1,0,1,0,0,0,1,0,0,0,1,1,1,1,0)
4	(0,0,0,1,1,0,1,0,1,1,1,0,0,1,0,0,0,0,0,1,1,0,1,0,1,1)
5	(0,1,0,0,1,1,1,0,1,0,1,1,0,0,0,0,0,1,0,0,1,1,1,0,1,0)
6	(1,0,1,0,0,1,1,1,1,1,0,1,1,0,0,0,1,0,1,0,0,1,1,1,1,1)
7	(1,1,1,0,1,1,1,1,0,0,0,1,0,0,1,0,1,1,1,0,1,1,1,1,0,0)

Table 5.2.3b TSC Set 2 - GMSK

Training Sequence Code (TSC)	Training sequence bits (BN61, BN62,...,BN86)
0	(0,1,1,0,0,0,1,0,0,0,1,0,0,1,0,0,1,1,1,0,1,0,1,1,1)
1	(0,1,0,1,1,1,1,0,1,0,0,1,1,0,1,1,1,0,1,1,1,0,0,0,0,1)
2	(0,1,0,0,0,0,0,1,0,1,1,0,0,0,1,1,1,0,1,1,1,0,1,1,0,0)
3	(0,0,1,0,1,1,0,1,1,1,0,1,1,1,0,0,1,1,1,1,0,1,0,0,0,0)
4	(0,1,1,1,0,1,0,0,1,1,1,1,0,1,0,0,1,1,1,0,1,1,1,1,1,0)
5	(0,1,0,0,0,0,0,1,0,0,1,1,0,1,0,1,0,0,1,1,1,1,0,0,1,1)
6	(0,0,0,1,0,0,0,0,1,1,0,1,0,0,0,0,1,1,0,1,1,1,0,1,0,1)
7	(0,1,0,0,0,1,0,1,1,1,0,0,1,1,1,1,1,1,0,0,1,0,1,0,0,1)

Table 5.2.3c TSC Set 3 - GMSK

Training Sequence Code (TSC)	Training sequence bits (BN61, BN62,...,BN86)
0	(1,1,0,0,0,0,1,0,0,1,0,0,0,1,1,1,1,0,1,0,1,0,0,0,1,0)
1	(0,0,1,0,1,1,1,1,0,0,0,1,0,0,1,0,1,0,0,0,0,1,0,0,0,0)
2	(1,1,0,0,1,0,0,0,1,1,1,1,0,1,1,1,0,1,0,1,0,1,1,0,1,1,0)
3	(0,0,1,1,0,0,0,0,1,0,1,0,0,1,1,0,0,0,0,0,1,0,1,1,0,0)
4	(0,0,0,1,1,1,1,0,1,0,1,1,1,0,1,0,0,0,0,0,1,0,0,0,1,1,0)
5	(1,1,0,0,1,1,1,1,0,1,0,1,0,1,1,1,1,0,0,1,0,0,0,0,0,0)
6	(1,0,1,1,1,0,0,1,1,0,1,0,1,1,1,1,1,1,0,0,0,1,0,0,0,0)
7	(1,1,1,0,0,1,0,1,1,1,1,0,1,1,1,0,0,0,0,0,1,0,0,1,0,0)

Table 5.2.3d TSC Set 4 - GMSK

Training Sequence Code (TSC)	Training sequence bits (BN61, Bn62,...,BN86)
0	(1,1,0,0,1,1,1,0,1,0,0,0,0,0,1,0,0,0,0,1,1,0,1,0,0,0,0)
1	(0,1,1,0,0,0,1,0,0,0,0,1,0,1,0,0,0,1,0,1,1,1,0,0,0,0)
2	(1,1,1,0,0,1,0,0,0,0,0,1,0,1,0,1,0,0,1,1,1,0,0,0,0,0)
3	(0,1,1,0,1,1,0,0,1,1,1,1,1,0,1,0,1,0,0,0,0,1,1,0,0,0)
4	(1,1,0,1,1,0,0,0,0,1,0,0,0,0,1,0,0,0,1,0,1,1,0,0,0,0)
5	(1,1,0,1,0,0,1,1,1,1,1,1,1,0,1,0,0,0,0,1,1,0,1,0,1,1,0)
6	(0,0,1,0,0,1,1,1,1,1,1,1,0,0,1,0,1,0,1,0,1,1,0,0,0,0)
7	(0,1,0,1,1,1,0,0,0,0,0,0,1,0,1,0,0,1,1,0,0,0,1,1,1,0)

NOTE: For COMPACT, for PDTCH/PACCH on primary and secondary carriers that are indicated in EXT\_FREQUENCY\_LIST by parameter INT\_FREQUENCY and in INT\_MEAS\_CHAN\_LIST (see subclauses 10.1.5 and 10.2.3.2.2 of 3GPP TS 45.008), the TSCs should be equal to the BCC, as defined in 3GPP TS 23.003 and as described in this technical specification in subclause 3.3.2, otherwise the accuracy of interference measurement reporting may be compromised.

For CTS control channels, the TSC shall be selected from TSC set 1 and defined by the 3 LSBs (BN3, BN2, BN1) of the FPBI (specified in 3GPP TS 23.003).

Under certain circumstances only half the encrypted bits present in a normal burst will contain complete information. For downlink DTX operation on TCH-FS and TCH-HS, when a traffic frame (as defined in 3GPP TS 46.031) is scheduled for transmission and one of its adjacent traffic frames is not scheduled for transmission, the other half of the encrypted bits in the normal bursts associated with the scheduled traffic frame shall contain partial SID information from any associated SID frame, with the appropriate stealing flags BN60 or BN87 set to 0. In other cases the binary state of the remaining bits is not specified.



### 5.2.3.2 Normal burst for AQPSK (downlink only)

This burst format shall be used in downlink in *VAMOS mode* when both the *VAMOS subchannels* in the *VAMOS pair* have bursts scheduled for transmission. The bits from the pair of Normal bursts for GMSK from the two *VAMOS subchannels* shall be interleaved together to form the Normal burst for AQPSK as follows (bits are grouped in symbols separated by ;):

$(BN^0, BN^1; BN^2, BN^3; \dots BN^{309}, BN^{310}, BN^{311}, BN^{312}, BN^{313}) = (BN^0_0, BN^1_0; BN^0_1, BN^1_1; \dots BN^0_{155}, BN^1_{155}; BN^0_{156}, BN^1_{156})$ ,  $BN^0_0, BN^0_1, \dots, BN^0_{156}$  and  $BN^1_0, BN^1_1, \dots, BN^1_{156}$  are the bits numbered  $BN^0, BN^1, \dots, BN^{156}$  in the Normal bursts for GMSK for each of the two *VAMOS subchannels* respectively.

The mapping of TSCs onto bit numbers for AQPSK is dependent on the TSC sets selection and shall follow table 5.2.3e:

**Table 5.2.3e. Mapping of TSC sets onto bit numbers depending on TSC set selection for AQPSK**

TSC set selected	
BN <sup>0</sup>	BN <sup>1</sup>
1	2
3	4
NOTE: If the TSC sets are not selected from the combinations listed above any mapping of TSCs onto bit numbers can be selected.	

### 5.2.3.3 Normal burst for 8PSK

**Table 5.2.3-3: Normal burst 8PSK**

Bit Number (BN)	Length of field (bits)	Content of field	Definition
0-8	9	Tail bits	see table 5.2.3-4
9-182	174	Encrypted bits (e0 . e173)	see 3GPP TS 45.003
183-260	78	Training sequence bits	see table 5.2.3f-g
261-434	174	Encrypted bits (e174 . e347)	see 3GPP TS 45.003
435-443	9	Tail bits	see table 5.2.3-4
444-467 444-468 444-470	24, 24.75, or 27 <sup>1</sup>	Guard period (bits)	see subclause 5.2.8
NOTE1: 24 or 27 always applies in case of EC-GSM-IoT, see 3GPP TS 45.010			

The "tail bits" are defined as modulating bits with states as shown in table 5.2.3-4 (bits are grouped in symbols separated by ;).

**Table 5.2.3-4: Tail bits**

Bit number (BN)	Modulating bits
(BN <sup>0</sup> , BN <sup>1</sup> , ..., BN <sup>8</sup> )	(1,1,1;1,1,1;1,1,1)
(BN <sup>435</sup> , BN <sup>436</sup> , ..., BN <sup>443</sup> )	(1,1,1;1,1,1;1,1,1)

The "training sequence bits" are defined as modulating bits with states as given in table 5.2.3f or table 5.2.3g, depending on if the TSC is assigned from TSC Set 1 or TSC Set 2, according to the training sequence code, TSC. The choice of the TSC set from which the training sequence bits are selected is described in 3GPP TS 44.018 and in 3GPP TS 44.060. . In networks supporting E-OTD Location services (see 3GPP TS 43.059), the use of normal bursts on BCCH frequencies with TSC from the TSC Set 2 might degrade E-OTD Location service performance.

**Table 5.2.3f TSC Set 1 – 8PSK**

Training Sequence Code (TSC)	Training sequence bits (BN183, B184,...,BN260)
0	(1,1,1;1,1,1;0,0,1;1,1,1;1,1,1;0,0,1;1,1,1;0,0,1;0,0,1;0,0,1;1,1,1;1,1,1;1,1,1;1,1,1;0,0,1;1,1,1;1,1,1;1,1,1;0,0,1;1,1,1;0,0,1;1,1,1;0,0,1;1,1,1;0,0,1;0,0,1;0,0,1)
1	(1,1,1;1,1,1;0,0,1;1,1,1;0,0,1;0,0,1;1,1,1;0,0,1;0,0,1;0,0,1;1,1,1;0,0,1;0,0,1;0,0,1;0,0,1;1,1,1;1,1,1;1,1,1;0,0,1;1,1,1;0,0,1;1,1,1;0,0,1;1,1,1;0,0,1;0,0,1;0,0,1)
2	(1,1,1;0,0,1;1,1,1;1,1,1;1,1,1;1,1,1;0,0,1;0,0,1;0,0,1;1,1,1;0,0,1;0,0,1;0,0,1;1,1,1;0,0,1;1,1,1;1,1,1;0,0,1;1,1,1;1,1,1;1,1,1;0,0,1;0,0,1;0,0,1;1,1,1)
3	(1,1,1;0,0,1;1,1,1;1,1,1;1,1,1;0,0,1;0,0,1;0,0,1;0,0,1;1,1,1;0,0,1;0,0,1;1,1,1;0,0,1;1,1,1;0,0,1;1,1,1;1,1,1;0,0,1;1,1,1;1,1,1;0,0,1;0,0,1;0,0,1;1,1,1)
4	(1,1,1;1,1,1;1,1,1;0,0,1;0,0,1;1,1,1;0,0,1;1,1,1;0,0,1;0,0,1;0,0,1;1,1,1;1,1,1;0,0,1;1,1,1;0,0,1;1,1,1;1,1,1;0,0,1;1,1,1;1,1,1;0,0,1;1,1,1;0,0,1;0,0,1)
5	(1,1,1;0,0,1;1,1,1;1,1,1;0,0,1;0,0,1;0,0,1;1,1,1;0,0,1;1,1,1;0,0,1;0,0,1;1,1,1;1,1,1;1,1,1;1,1,1;0,0,1;1,1,1;1,1,1;0,0,1;0,0,1;1,1,1;0,0,1;1,1,1)
6	(0,0,1;1,1,1;0,0,1;1,1,1;1,1,1;0,0,1;0,0,1;0,0,1;0,0,1;0,0,1;1,1,1;0,0,1;0,0,1;1,1,1;1,1,1;1,1,1;0,0,1;1,1,1;0,0,1;1,1,1;0,0,1;1,1,1;0,0,1;0,0,1)
7	(0,0,1;0,0,1;0,0,1;1,1,1;0,0,1;0,0,1;0,0,1;0,0,1;0,0,1;1,1,1;1,1,1;1,1,1;0,0,1;1,1,1;1,1,1;0,0,1;1,1,1;0,0,1;1,1,1;0,0,1;0,0,1;0,0,1;0,0,1;1,1,1)

**Table 5.2.3g TSC Set 2 – 8PSK**

Training Sequence Code (TSC)	Training sequence bits (BN183, B184,...,BN260)
0	(1,1,1;1,1,1;1,1,1;1,1,1;1,1,1;0,0,1;1,1,1;0,0,1;0,0,1;1,1,1;1,1,1;1,1,1;1,1,1;0,0,1;1,1,1;0,0,1;1,1,1;1,1,1;0,0,1;0,0,1;1,1,1;0,0,1;1,1,1;0,0,1;1,1,1)
1	(1,1,1;0,0,1;0,0,1;0,0,1;0,0,1;1,1,1;0,0,1;0,0,1;1,1,1;0,0,1;1,1,1;0,0,1;1,1,1;0,0,1;0,0,1;0,0,1;0,0,1;1,1,1;0,0,1;1,1,1;0,0,1;1,1,1;0,0,1;1,1,1)
2	(0,0,1;1,1,1;0,0,1;1,1,1;1,1,1;0,0,1;0,0,1;0,0,1;1,1,1;0,0,1;1,1,1;0,0,1;0,0,1;0,0,1;0,0,1;0,0,1;0,0,1;1,1,1;0,0,1;1,1,1;0,0,1;1,1,1;0,0,1;1,1,1)
3	(1,1,1;1,1,1;0,0,1;1,1,1;0,0,1;0,0,1;0,0,1;1,1,1;0,0,1;0,0,1;0,0,1;0,0,1;1,1,1;0,0,1;0,0,1;0,0,1;1,1,1;0,0,1;1,1,1;0,0,1;1,1,1;0,0,1;1,1,1;0,0,1;1,1,1)
4	(1,1,1;0,0,1;0,0,1;0,0,1;0,0,1;1,1,1;0,0,1;1,1,1;1,1,1;0,0,1;0,0,1;1,1,1;1,1,1;0,0,1;1,1,1;1,1,1;0,0,1;1,1,1;1,1,1;0,0,1;1,1,1;0,0,1;1,1,1;0,0,1;1,1,1)
5	(1,1,1;0,0,1;1,1,1;0,0,1;0,0,1;0,0,1;0,0,1;1,1,1;0,0,1;1,1,1;0,0,1;1,1,1;0,0,1;1,1,1;0,0,1;0,0,1;1,1,1;0,0,1;1,1,1;1,1,1;0,0,1;1,1,1;0,0,1;1,1,1)
6	(0,0,1;0,0,1;0,0,1;0,0,1;0,0,1;1,1,1;0,0,1;1,1,1;0,0,1;0,0,1;1,1,1;0,0,1;1,1,1;0,0,1;1,1,1;1,1,1;0,0,1;1,1,1;0,0,1;1,1,1;0,0,1;1,1,1;0,0,1;1,1,1)
7	(0,0,1;0,0,1;0,0,1;0,0,1;0,0,1;0,0,1;0,0,1;1,1,1;1,1,1;0,0,1;1,1,1;0,0,1;1,1,1;0,0,1;1,1,1;0,0,1;0,0,1;0,0,1;1,1,1;1,1,1;0,0,1;0,0,1;1,1,1)

5.2.3.4 Normal burst for 16QAM

Bit Number (BN)	Length of field (bits)	Contents of field	Definition
0 – 11	12	tail bits	(below)
12 – 243	232	encrypted bits (e0 . e231)	45.003
244 – 347	104	training sequence bits	(below)
348 – 579	232	encrypted bits (e232 . e463)	45.003
580 – 591	12	tail bits	(below)
592 - 624	33	guard period	subclause 5.2.8

- where the "tail bits" are defined as modulating bits with states as follows (bits are grouped in symbols separated by ;):

(BN0, BN1 .. BN11) = (0,0,0,1; 0,1,1,0; 0,1,1,0) and

(BN580, BN581 .. BN591) = (0,0,0,1; 0,1,1,0; 0,1,1,0)

- where the "training sequence bits" are defined as modulating bits with states as given in the table 5.2.3h or 5.2.3i, depending on if the TSC is assigned from TSC Set 1 or TSC Set 2, according to the training sequence code, TSC. The choice of the TSC set from which the training sequence bits are selected is described in 3GPP TS 44.018 and in 3GPP TS 44.060.. In networks supporting E-OTD Location services (see 3GPP TS 43.059), the use of 16QAM modulation on BCCH frequencies might degrade E-OTD Location service performance.

**Table 5.2.3h TSC Set 1 – 16QAM**

Training Sequence Code (TSC)	Training sequence bits (BN244, BN245,...,BN347)
0	(1,1,1,1;1,1,1,1;0,0,1,1;1,1,1,1;1,1,1,1;0,0,1,1;1,1,1,1;0,0,1,1;0,0,1,1;0,0,1,1;0,0,1,1;1,1,1,1;1,1,1,1;1,1,1,1;1,1,1,1;1,1,1,1;0,0,1,1;1,1,1,1;1,1,1,1;1,1,1,1;0,0,1,1;1,1,1,1;1,1,1,1;0,0,1,1;1,1,1,1;0,0,1,1;0,0,1,1;0,0,1,1)
1	(1,1,1,1;1,1,1,1;0,0,1,1;1,1,1,1;0,0,1,1;0,0,1,1;1,1,1,1;0,0,1,1;0,0,1,1;0,0,1,1;0,0,1,1;1,1,1,1;0,0,1,1;0,0,1,1;0,0,1,1;0,0,1,1;0,0,1,1;0,0,1,1;1,1,1,1;1,1,1,1;1,1,1,1;1,1,1,1;0,0,1,1;1,1,1,1;1,1,1,1;0,0,1,1;0,0,1,1;0,0,1,1)
2	(1,1,1,1;0,0,1,1;1,1,1,1;1,1,1,1;1,1,1,1;1,1,1,1;0,0,1,1;0,0,1,1;0,0,1,1;0,0,1,1;1,1,1,1;0,0,1,1;0,0,1,1;1,1,1,1;0,0,1,1;0,0,1,1;0,0,1,1;1,1,1,1;1,1,1,1;1,1,1,1;1,1,1,1;0,0,1,1;0,0,1,1;0,0,1,1;0,0,1,1;1,1,1,1)
3	(1,1,1,1;0,0,1,1;1,1,1,1;1,1,1,1;1,1,1,1;0,0,1,1;0,0,1,1;0,0,1,1;0,0,1,1;0,0,1,1;1,1,1,1;0,0,1,1;0,0,1,1;0,0,1,1;0,0,1,1;0,0,1,1;0,0,1,1;1,1,1,1;1,1,1,1;1,1,1,1;1,1,1,1;0,0,1,1;1,1,1,1;1,1,1,1;0,0,1,1;0,0,1,1;1,1,1,1)
4	(1,1,1,1;1,1,1,1;1,1,1,1;0,0,1,1;0,0,1,1;1,1,1,1;0,0,1,1;1,1,1,1;0,0,1,1;0,0,1,1;0,0,1,1;1,1,1,1;1,1,1,1;1,1,1,1;0,0,1,1;1,1,1,1;1,1,1,1;1,1,1,1;1,1,1,1;1,1,1,1;1,1,1,1;0,0,1,1;0,0,1,1;1,1,1,1;0,0,1,1;0,0,1,1)
5	(1,1,1,1;0,0,1,1;1,1,1,1;1,1,1,1;0,0,1,1;0,0,1,1;0,0,1,1;1,1,1,1;0,0,1,1;1,1,1,1;0,0,1,1;0,0,1,1;0,0,1,1;1,1,1,1;0,0,1,1;1,1,1,1;1,1,1,1;0,0,1,1;1,1,1,1;1,1,1,1;0,0,1,1;0,0,1,1;1,1,1,1;0,0,1,1;1,1,1,1)
6	(0,0,1,1;1,1,1,1;0,0,1,1;1,1,1,1;1,1,1,1;0,0,1,1;0,0,1,1;0,0,1,1;0,0,1,1;0,0,1,1;0,0,1,1;1,1,1,1;0,0,1,1;0,0,1,1;0,0,1,1;1,1,1,1;1,1,1,1;1,1,1,1;0,0,1,1;1,1,1,1;0,0,1,1;1,1,1,1;0,0,1,1;0,0,1,1;0,0,1,1)
7	(0,0,1,1;0,0,1,1;0,0,1,1;1,1,1,1;0,0,1,1;1,1,1,1;0,0,1,1;0,0,1,1;0,0,1,1;0,0,1,1;1,1,1,1;1,1,1,1;1,1,1,1;0,0,1,1;1,1,1,1;1,1,1,1;0,0,1,1;1,1,1,1;0,0,1,1;0,0,1,1;1,1,1,1;0,0,1,1;0,0,1,1;1,1,1,1)

**Table 5.2.3i TSC Set 2 – 16QAM**

Training Sequence Code (TSC)	Training sequence bits (BN244, BN245,...,BN347)
0	(0,0,1,1;1,1,1,1;1,1,1,1;1,1,1,1;0,0,1,1;1,1,1,1;0,0,1,1;0,0,1,1;0,0,1,1;0,0,1,1;1,1,1,1;0,0,1,1;0,0,1,1;0,0,1,1;0,0,1,1;0,0,1,1;1,1,1,1;1,1,1,1;1,1,1,1;1,1,1,1)
1	(0,0,1,1;0,0,1,1;0,0,1,1;1,1,1,1;1,1,1,1;1,1,1,1;0,0,1,1;0,0,1,1;0,0,1,1;0,0,1,1;0,0,1,1;1,1,1,1;0,0,1,1;0,0,1,1;0,0,1,1;0,0,1,1;1,1,1,1;0,0,1,1;1,1,1,1;1,1,1,1;1,1,1,1)
2	(0,0,1,1;1,1,1,1;1,1,1,1;0,0,1,1;0,0,1,1;0,0,1,1;1,1,1,1;0,0,1,1;0,0,1,1;1,1,1,1;0,0,1,1;1,1,1,1;0,0,1,1;1,1,1,1;0,0,1,1;0,0,1,1;1,1,1,1;0,0,1,1;1,1,1,1;0,0,1,1;1,1,1,1)
3	(1,1,1,1;1,1,1,1;0,0,1,1;0,0,1,1;0,0,1,1;1,1,1,1;0,0,1,1;0,0,1,1;0,0,1,1;0,0,1,1;1,1,1,1;0,0,1,1;0,0,1,1;1,1,1,1;0,0,1,1;0,0,1,1;1,1,1,1;0,0,1,1;1,1,1,1;1,1,1,1;1,1,1,1)
4	(0,0,1,1;1,1,1,1;0,0,1,1;1,1,1,1;1,1,1,1;0,0,1,1;1,1,1,1;0,0,1,1;0,0,1,1;0,0,1,1;0,0,1,1;0,0,1,1;0,0,1,1;0,0,1,1;0,0,1,1;1,1,1,1;1,1,1,1;0,0,1,1;1,1,1,1;0,0,1,1;1,1,1,1)
5	(1,1,1,1;1,1,1,1;1,1,1,1;0,0,1,1;0,0,1,1;1,1,1,1;0,0,1,1;1,1,1,1;0,0,1,1;0,0,1,1;1,1,1,1;0,0,1,1;0,0,1,1;1,1,1,1;0,0,1,1;0,0,1,1;1,1,1,1;0,0,1,1;0,0,1,1;1,1,1,1)
6	(1,1,1,1;1,1,1,1;1,1,1,1;0,0,1,1;0,0,1,1;1,1,1,1;0,0,1,1;1,1,1,1;0,0,1,1;1,1,1,1;1,1,1,1;1,1,1,1;1,1,1,1;0,0,1,1;1,1,1,1;1,1,1,1;0,0,1,1;0,0,1,1;0,0,1,1;1,1,1,1)
7	(1,1,1,1;0,0,1,1;1,1,1,1;0,0,1,1;0,0,1,1;1,1,1,1;1,1,1,1;1,1,1,1;1,1,1,1;1,1,1,1;1,1,1,1;0,0,1,1;1,1,1,1;1,1,1,1;0,0,1,1;1,1,1,1;0,0,1,1;0,0,1,1;0,0,1,1;1,1,1,1)



Table 5.2.3k TSC Set 2 – 32QAM

Training Sequence Code (TSC)	Training sequence bits (BN305, BN306,...,BN434)
0	(1,0,0,1,0;0,0,0,0,0;1,0,0,1,0;0,0,0,0,0;1,0,0,1,0;0,0,0,0,0;1,0,0,1,0;0,0,0,0,0;0,0,0,0,0;0,0,0,0,0;0,0,0,0,0;0,0,0,0,0;1,0,0,1,0;1,0,0,1,0;1,0,0,1,0;0,0,0,0,0;1,0,0,1,0;0,0,0,0,0;0,0,0,0,0;1,0,0,1,0;1,0,0,1,0;1,0,0,1,0;0,0,0,0,0;0,0,0,0,0;1,0,0,1,0;0,0,0,0,0;0,0,0,0,0)
1	(0,0,0,0,0;0,0,0,0,0;1,0,0,1,0;1,0,0,1,0;0,0,0,0,0;1,0,0,1,0;0,0,0,0,0;0,0,0,0,0;1,0,0,1,0;1,0,0,1,0;1,0,0,1,0;0,0,0,0,0;1,0,0,1,0;0,0,0,0,0;1,0,0,1,0;0,0,0,0,0;0,0,0,0,0;0,0,0,0,0;0,0,0,0,0;1,0,0,1,0;1,0,0,1,0;0,0,0,0,0;1,0,0,1,0;0,0,0,0,0;0,0,0,0,0;0,0,0,0,0;0,0,0,0,0;0,0,0,0,0)
2	(1,0,0,1,0;0,0,0,0,0;0,0,0,0,0;1,0,0,1,0;1,0,0,1,0;0,0,0,0,0;0,0,0,0,0;0,0,0,0,0;0,0,0,0,0;1,0,0,1,0;0,0,0,0,0;1,0,0,1,0;0,0,0,0,0;0,0,0,0,0;1,0,0,1,0;0,0,0,0,0;0,0,0,0,0;1,0,0,1,0;0,0,0,0,0;0,0,0,0,0;1,0,0,1,0;1,0,0,1,0;1,0,0,1,0;0,0,0,0,0;1,0,0,1,0;0,0,0,0,0;0,0,0,0,0;1,0,0,1,0;0,0,0,0,0)
3	(0,0,0,0,0;0,0,0,0,0;0,0,0,0,0;1,0,0,1,0;1,0,0,1,0;1,0,0,1,0;0,0,0,0,0;1,0,0,1,0;0,0,0,0,0;1,0,0,1,0;1,0,0,1,0;1,0,0,1,0;0,0,0,0,0;0,0,0,0,0;1,0,0,1,0;1,0,0,1,0;1,0,0,1,0;0,0,0,0,0;0,0,0,0,0;1,0,0,1,0;1,0,0,1,0;1,0,0,1,0;0,0,0,0,0;0,0,0,0,0;0,0,0,0,0;0,0,0,0,0;0,0,0,0,0)
4	(0,0,0,0,0;0,0,0,0,0;1,0,0,1,0;0,0,0,0,0;1,0,0,1,0;0,0,0,0,0;0,0,0,0,0;1,0,0,1,0;1,0,0,1,0;1,0,0,1,0;1,0,0,1,0;0,0,0,0,0;1,0,0,1,0;0,0,0,0,0;0,0,0,0,0;0,0,0,0,0;1,0,0,1,0;0,0,0,0,0;0,0,0,0,0;0,0,0,0,0;1,0,0,1,0;0,0,0,0,0;0,0,0,0,0;0,0,0,0,0;0,0,0,0,0)
5	(1,0,0,1,0;0,0,0,0,0;0,0,0,0,0;0,0,0,0,0;1,0,0,1,0;1,0,0,1,0;1,0,0,1,0;0,0,0,0,0;1,0,0,1,0;0,0,0,0,0;0,0,0,0,0;1,0,0,1,0;1,0,0,1,0;0,0,0,0,0;1,0,0,1,0;0,0,0,0,0;1,0,0,1,0;1,0,0,1,0;1,0,0,1,0;0,0,0,0,0;1,0,0,1,0;0,0,0,0,0;0,0,0,0,0;0,0,0,0,0;0,0,0,0,0)
6	(1,0,0,1,0;1,0,0,1,0;1,0,0,1,0;1,0,0,1,0;0,0,0,0,0;0,0,0,0,0;1,0,0,1,0;0,0,0,0,0;1,0,0,1,0;0,0,0,0,0;1,0,0,1,0;1,0,0,1,0;0,0,0,0,0;1,0,0,1,0;0,0,0,0,0;0,0,0,0,0;0,0,0,0,0;0,0,0,0,0;1,0,0,1,0;1,0,0,1,0;0,0,0,0,0;0,0,0,0,0;0,0,0,0,0;0,0,0,0,0)
7	(1,0,0,1,0;1,0,0,1,0;0,0,0,0,0;1,0,0,1,0;1,0,0,1,0;1,0,0,1,0;0,0,0,0,0;0,0,0,0,0;1,0,0,1,0;1,0,0,1,0;1,0,0,1,0;1,0,0,1,0;0,0,0,0,0;1,0,0,1,0;0,0,0,0,0;1,0,0,1,0;0,0,0,0,0;0,0,0,0,0;1,0,0,1,0;0,0,0,0,0;0,0,0,0,0;0,0,0,0,0)

### 5.2.3a Higher symbol rate burst (HB)

#### Higher symbol rate burst for QPSK

Bit Number (BN)	Length of field (bits)	Contents of field	Definition
0 – 7	8	tail bits	(below)
8 – 145	138	encrypted bits (e0 . e137)	45.003
146 – 207	62	training sequence bits	(below)
208 – 345	138	encrypted bits (e138 . e275)	45.003
346 – 353	8	tail bits	(below)
354 - 374	21	guard period	Subclause 5.2.8

- where the "tail bits" are defined as modulating bits with states as follows (bits are grouped in symbols separated by ;):

(BN0, BN1 .. BN7) = (0,0;0,1;1,1;1,0) and

(BN346, BN347 .. BN353) = (0,0;0,1;1,1;1,0)

- where the "training sequence bits" are defined as modulating bits with states as given in the following table according to the training sequence code, TSC. For BCCH and CCCH, the TSC must be equal to the BCC, as defined in 3GPP TS 23.003. In networks supporting E-OTD Location services (see 3GPP TS 43.059), the use of QPSK modulation on BCCH frequencies might degrade E-OTD Location service performance.













	(0, 1, 0, 1, 1, 1, 1, 0, 0, 1, 1, 1, 0, 1, 0, 1, 1, 1, 1, 0, 1, 1, 0, 1, 0, 0, 1, 1, 0, 0, 0, 1, 0, 0, 1, 1, 0, 0, 0, 1, 0, 1, 1, 1)	3	For operation on EC-RACH in case "TS6" is used <sup>1,2</sup>
	(0, 1, 0, 0, 0, 0, 1, 0, 1, 1, 0, 0, 0, 0, 0, 1, 1, 1, 0, 1, 0, 0, 1, 0, 1, 1, 1, 0, 0, 1, 0, 0, 1, 1, 1, 0, 0, 0, 1, 0, 0, 0, 0)	4	For operation on EC-RACH in case "TS7" is used <sup>1,2</sup>
NOTE1: see 3GPP TS 44.018.			
NOTE2: The synch. sequences for TS5, TS6 and TS7 apply also for EC-RACH operation in CC5 using EDAB, see sub-clauses 5.2.11 and 6.3.2.2.6.			

## 5.2.8 Guard period

The guard period is provided because it is required for the MSs that transmission be attenuated for the period between bursts with the necessary ramp up and down occurring during the guard periods as defined in 3GPP TS 45.005. A base transceiver station is not required to have a capability to ramp down and up between adjacent bursts, but is required to have a capability to ramp down and up for non-used time-slots, as defined in 3GPP TS 45.005. In any case where the amplitude of transmission is ramped up and down, then by applying an appropriate modulation bit stream interference to other RF channels can be minimized.

In some cases, there is more than one option for the duration of the guard period. The actual duration of the guard period between bursts with different symbol rates is defined in 3GPP TS 45.010.

## 5.2.9 Extended Access burst (Extended AB)

**Table 5.2.9-1: Extended Access Burst**

Bit Number (BN)	Length of field	Content of field	Definition
0-7	8	Extended tail bits	see table 5.2.9-2
8-48	41	Synch. sequence bits	see table 5.2.7-3 and table 5.2.7-4
49-84	36	Encrypted bits part 1 (e0..e35)	see 3GPP TS 45.003
85-87	3	Tail bits 1	see table 5.2.9-2
88-144	57	Encrypted bits part 2 (e36..e92)	see 3GPP TS 45.003
145-147	3	Tail bits 2	see table 5.2.9-2
148-155 148-156	8, 8.25, or, 9 <sup>1</sup>	Guard period (bits)	see subclause 5.2.8
NOTE1: 8 or 9 always applies in case of EC-GSM-IoT, see 3GPP TS 45.010			

The "extended tail bits", "tail bits 1" and "tail bits 2" are defined as modulating bits with states according to table 5.2.9-2.

**Table 5.2.9-2: Tail bits and extended tail bits**

Tail bit type	Bit number (BN)	Modulating bits
Extended tail bits	(BN0, BN1, BN2 .. BN7)	(0, 0, 1, 1, 1, 0, 1, 0)
Tail bits 1	(BN85, BN86, BN87)	(0, 0, 0)
Tail bits 2	(BN145, BN146, BN147)	(0, 0, 0)

The "Synch. sequence bits" are defined as modulating bits with states according to table 5.2.7-3 and 5.2.7-4. They are identical to those used for the access burst.



- if parameters CC2\_Range\_UL, CC3\_Range\_UL are not present (indicating the absence of CC2 and CC3 coverage classes), TS 6 is selected.

**Table 5.2.11-1a: Extended Dual slot Access Burst (first part)**

Bit Number (BN)	Length of field	Content of field	Definition
0-7	8	Extended tail bits	see table 5.2.11-2
8-48	41	Synch. sequence bits	see table 5.2.7-4
49-78	30	Encrypted bits (e0..e29)	see 3GPP TS 45.003
79-81	3	Tail bits 1	see table 5.2.11-2
82-111	30	Encrypted bits (e0..e29)	see 3GPP TS 45.003
112-114	3	Tail bits 2	see table 5.2.11-2
115-144	30	Encrypted bits (e0..e29)	see 3GPP TS 45.003
145-147	3	Tail bits 3	see table 5.2.11-2
148-155 148-156	8, or, 9 <sup>1</sup>	Guard period (bits)	see subclause 5.2.8
NOTE1: 8 or 9 always applies in case of EC-GSM-IoT (9 for TN0 and 4; 8 for TN2 and 6), see 3GPP TS 45.010			

The "extended tail bits", "tail bits 1", "tail bits 2" and "tail bits 3" are defined as modulating bits with states according to table 5.2.11-2.

**Table 5.2.11-1b: Extended Dual slot Access Burst (second and last part)**

Bit Number (BN)	Length of field	Content of field	Definition
0-7	8	Extended tail bits	see table 5.2.11-2
8-48	41	Synch. sequence bits	see table 5.2.7-4
49-78	30	Encrypted bits (e0..e29)	see 3GPP TS 45.003
79-87	9	Tail bits 4	see table 5.2.11-2
88-155	68 <sup>1</sup>	Guard period (bits)	see subclause 5.2.8
NOTE1: 68 always applies in case of EC-GSM-IoT for TN 1, 3, 5 and 7, see 3GPP TS 45.010			

The "extended tail bits" and "tail bits 4" are defined as modulating bits with states according to table 5.2.11-2.

**Table 5.2.11-2: Tail bits and extended tail bits**

Tail bit type	Bit number (BN)	Modulating bits
Extended tail bits	(BN0, BN1, BN2, ..., BN7)	(0, 0, 1, 1, 1, 0, 1, 0)
Tail bits 1	(BN79, BN80, BN81)	$(0, 0, 0)^1 / (1, 1, 1)^2 / (1, 0, 0)^3$
Tail bits 2	(BN112, BN113, BN114)	$(0, 0, 0)^1 / (1, 1, 1)^2 / (1, 0, 0)^3$
Tail bits 3	(BN145, BN146, BN147)	$(0, 0, 0)^1 / (1, 1, 1)^2 / (1, 0, 0)^3$
Tail bits 4	(BN79, BN80, ..., BN87)	$(0, 0, 0, 0, 0, 0, 0, 0, 0)^1 / (1, 1, 1, 1, 1, 1, 1, 1, 1)^2 / (1, 0, 0, 1, 0, 0, 1, 0, 0)^3$
NOTE 1: These bits are used if TS7 is applied for CC5 EC-RACH operation using EDAB. NOTE 2: These bits are used if TS6 is applied for CC5 EC-RACH operation using EDAB. NOTE 3: These bits are used if TS5 is applied for CC5 EC-RACH operation using EDAB.		

The "Synch. sequence bits" are defined as modulating bits with states according to table 5.2.7-4 for uplink CC5.

## 5.3 Physical channels and bursts

The description of a physical channel will be made in terms of timeslots and TDMA frames and not in terms of bursts. This is because there is not a one to one mapping between a particular physical channel, and the use of a particular burst.

## 5.4 Radio frequency channel sequence

The radio frequency channel sequence is determined by a function that, in a given cell, with a given set of general parameters, (see subclause 5.6.2), with a given timeslot number (TN), a given mobile radio frequency channel allocation (MA) and a given mobile allocation index offset (MAIO), maps the TDMA frame number (FN) to a radio frequency channel.

In a given cell there is therefore, for a physical channel assigned to a particular mobile, a unique correspondence between radio frequency channel and TDMA frame number.

The detailed hopping generation algorithm is given in subclause 6.2.

## 5.5 Timeslot and TDMA frame sequence

A given physical channel shall always use the same timeslot number in every TDMA frame. Therefore a timeslot sequence is defined by:

- i) a timeslot number (TN); and
- ii) a TDMA frame number sequence.

The detailed definitions of TDMA frame number sequences are given in clause 7.

The physical channels where the TDMA frame number sequence is 0,1.. FN\_MAX (where FN\_MAX is defined in subclause 4.3.3) are called "basic physical channels".

## 5.6 Parameters for channel definition and assignment

### 5.6.1 General

This subclause describes the set of parameters necessary to describe fully the mapping of any logical channel onto one or more physical channel(s). These parameters may be divided into general parameters, that are characteristic of a particular base transceiver station, and specific parameters, that are characteristic of a given physical channel.

### 5.6.2 General parameters

#### 5.6.2.1 General

These are:

- i) the set of radio frequency channels used in the cell (CA), together with the identification of the BCCH carrier.
- ii) the TDMA frame number (FN), which can be derived from the reduced TDMA frame number (RFN) which is in the form T1, T2, T3', see 3.3.2.

These parameters are broadcast (or derived from parameters broadcast) in the BCCH and SCH.

An exception applies for COMPACT and EC-GSM-IoT, where the general parameters are derived as described in subclause 5.6.2.2 and 5.6.2.3 respectively.

#### 5.6.2.2 COMPACT

For COMPACT, these are:

- i) the set of radio frequency channels used in the cell (CA), together with the identification of the COMPACT CPBCCCH carrier (primary COMPACT carrier).
- ii) the TDMA frame number (FN), which can be derived from the reduced TDMA frame number (RFN) which is in the form R1 and R2, see 3.3.2.
- iii) the time group number (TG)

These parameters are broadcast (or derived from parameters broadcast) in the COMPACT CPBCCCH and CSCH.

### 5.6.2.3 EC-GSM-IoT

For EC-GSM-IoT, these are:

- i) the set of radio frequency channels used in the cell (CA), together with the identification of the BCCH carrier.
- ii) the TDMA frame number (FN), which can be derived from the reduced TDMA frame number per quarter hyperframe (RFN<sub>QH</sub>) which in turn is derived from T1', T2', T2'', T3, see 3.3.2.2.3, and the QUARTER\_HYPERFRAME\_INDICATOR (see 3GPP TS 44.018).

These parameters are:

- broadcast in the EC-BCCH (CA parameter),
- derived in FCCH acquisition (T3 parameter)
- derived from EC-SCH (T1', T2', T2'' parameters), and,
- included within assignment messages sent on the EC-AGCH (QUARTER\_HYPERFRAME\_INDICATOR parameter).

### 5.6.3 Specific parameters

These parameters define a particular physical channel in a base transceiver station. They are:

- o) the training sequence Code (TSC);
- i) the timeslot number (TN);
- ii) the mobile radio frequency channel allocation (MA);
- iii) the mobile allocation index offset (MAIO);
- iv) the hopping sequence number (HSN);
- v) the type of logical channel;
- vi) the sub-channel number (SCN).

The last two parameters allow the determination of the frame sequence.

---

## 6 Mapping of logical channels onto physical channels

### 6.1 General

The detailed mapping of logical channels onto physical channels is defined in the following sections. Subclause 6.2 defines the mapping from TDMA frame number (FN) to radio frequency channel (RFCH). Subclause 6.3 defines the mapping of the physical channel onto TDMA frame number. Subclause 6.4 lists the permitted channel combinations and subclause 6.5 defines the operation of channels and channel combinations.

In case of *VAMOS subchannels*, the mapping of the logical channels onto the physical channels in uplink and downlink is done as defined for the corresponding TCH channels in subclauses 6.2 and 6.3. In downlink if 2 *VAMOS subchannels* have bursts scheduled for transmission on a given timeslot in a given TDMA frame and on a given ARFCN, then the bits from the 2 *VAMOS subchannels* are mapped on to AQPSK symbols (see subclause 5.2.3).

## 6.2 Mapping in frequency of logical channels onto physical channels

### 6.2.1 General

The parameters used in the function which maps TDMA frame number onto radio frequency channel are defined in subclause 6.2.2. The definition of the actual mapping function, or as it is termed, hopping sequence generation is given in subclause 6.2.3.

In CTS, the specific mapping in frequency depends on the start condition defined by the parameters given in subclause 6.2.2. The hopping sequence generation for CTS is given in subclause 6.2.3.

### 6.2.2 Parameters

The following parameters are required in the mapping from TDMA frame number to radio frequency channel for a given assigned channel.

General parameters of the BTS, specific to one BTS, and broadcast in the (EC-)BCCH, (EC-)SCH and FCCH:

i) CA: Cell allocation of radio frequency channels.

ii) FN: TDMA frame number, derived from information,

Broadcast in the SCH, see subclause 3.3.2.2.1.

For COMPACT: Broadcast in the CSCH, see subclause 3.3.2.2.2.

For EC-GSM-IoT: Broadcast in the EC-SCH, derived from the timing of FCCH bursts, and included within assignment message, see subclause 3.3.2.2.3.

Specific parameters of the channel, defined in the channel assignment message:

i) MA: Mobile allocation of radio frequency channels, defines the set of radio frequency channels to be used in the mobiles hopping sequence. The MA contains N radio frequency channels, where  $1 \leq N \leq 64$ .

For COMPACT, the reduced MA (see 3GPP TS 44.060) shall be used for a fixed amount of data blocks, see section 6.2.4.

For EC-GSM-IoT, the EC\_MA\_NUMBER (see 3GPP TS 44.060) is included in the channel assignment message. The EC\_MA\_NUMBER is defined in EC SI where the MA is included.

ii) MAIO: Mobile allocation index offset.(0 to N-1, 6 bits).

For COMPACT, MAIO\_2 shall be used for the data blocks using the reduced MA.

For EC-GSM-IoT, the EC\_MA\_NUMBER (see 3GPP TS 44.060) is included in the channel assignment message. The EC\_MA\_NUMBER is defined in EC SI where the MAIO is included.

iii) HSN: Hopping sequence (generator) number (0 to 63, 6 bits).

For EC-GSM-IoT, the EC\_MA\_NUMBER (see 3GPP TS 44.060) is included in the channel assignment message. The EC\_MA\_NUMBER is defined in EC SI where the HSN is included.

In CTS, the following parameters are required in the mapping to radio frequency channel for a CTS-FP and CTS-MS pair. They are given by the CTS-FP to the CTS-MS during the non-hopping access procedure :



- i) VA: the vector  $\underline{a}$  defines the elements which are used from the shift register to generate the codeword. The vector  $\underline{a}$  shall be randomly chosen upon up to 16 non-repeating integer elements where  $0 \leq a_i < 16$  and  $a_i \neq a_j$  for  $i \neq j$ .
- ii) VV: the elements of vector  $\underline{v}$  are added modulo 2 to the codeword from the shift register. For vector  $\underline{v}$ , up to 16 binary elements shall be chosen randomly.

NOTE: The length of the vectors  $\underline{a}$  and  $\underline{v}$  is dependent on the number of frequencies used for the hopping and can be truncated according to the number of frequencies used (see vi) below).

- iii) CSR: current shift register contents. In order that a CTS-MS is able to synchronize on a running hopping sequence the CTS-FP transmits the CSR.

iv) TFHC1: value of counter TFHC1.

v) TFHC2: value of counter TFHC2.

- vi) TFH carrier list (see 3GPP TS 45.056): ordered list of frequencies, with 1<sup>st</sup> freq referenced by the frequency index 1, 2<sup>nd</sup> frequency referenced by the frequency index 2, etc.

The number of frequencies in the TFH carrier list, NF shall be computed. The number of elements to be taken from the vectors  $\underline{a}$  and  $\underline{v}$  shall be determined by the function  $\lceil \log_2 \text{NF} \rceil$

- vii) VC: the vector  $\underline{c}$  is the base sequence to map the codeword. It shall be randomly chosen upon NF non-repeating integer elements:

$$c = \{c_0, c_1, \dots, c_{\text{NF}-1}\}, 0 \leq c_i < \text{NF} \text{ and } c_i \neq c_j \text{ for } i \neq j.$$

### 6.2.3 Hopping sequence generation

For a given set of parameters, the index to an absolute radio frequency channel number (ARFCN) within the mobile allocation (MAI from 0 to N-1, where MAI=0 represents the lowest ARFCN in the mobile allocation, ARFCN is in the range 0 to 1023 and the frequency value can be determined according to 3GPP TS 45.005), is obtained with the following algorithm:

**if** HSN = 0 (cyclic hopping) **then:**

$$\text{MAI, integer } (0 \dots N-1) : \text{MAI} = (\text{FN} + \text{MAIO}) \text{ modulo } N$$

**else:**

$$M, \text{ integer } (0 \dots 152) : M = T2 + \text{RNTABLE}((\text{HSN} \text{ xor } T1R) + T3)$$

$$S, \text{ integer } (0 \dots N-1) : M' = M \text{ modulo } (2 \wedge \text{NBIN})$$

$$T' = T3 \text{ modulo } (2 \wedge \text{NBIN})$$

**if**  $M' < N$  **then:**

$$S = M'$$

**else:**

$$S = (M' + T') \text{ modulo } N$$

$$\text{MAI, integer } (0 \dots N-1) : \text{MAI} = (S + \text{MAIO}) \text{ modulo } N$$

NOTE: Due to the procedure used by the mobile for measurement reporting when DTX is used, the use of cyclic hopping where  $(N) \bmod 13 = 0$  should be avoided.

where:

T1R: time parameter T1, reduced modulo 64 (6 bits)

T3: time parameter, from 0 to 50 (6 bits)

T2: time parameter, from 0 to 25 (5 bits)

NBIN: number of bits required to represent  $N = \text{INTEGER}(\log_2(N)+1)$

$\wedge$ : raised to the power of

xor: bit-wise exclusive or of 8 bit binary operands

RNTABLE: Table of 114 integer numbers, defined below:

Address	Contents									
000...009:	48,	98,	63,	1,	36,	95,	78,	102,	94,	73,
010...019:	0,	64,	25,	81,	76,	59,	124,	23,	104,	100,
020...029:	101,	47,	118,	85,	18,	56,	96,	86,	54,	2,
030...039:	80,	34,	127,	13,	6,	89,	57,	103,	12,	74,
040...049:	55,	111,	75,	38,	109,	71,	112,	29,	11,	88,
050...059:	87,	19,	3,	68,	110,	26,	33,	31,	8,	45,
060...069:	82,	58,	40,	107,	32,	5,	106,	92,	62,	67,
070...079:	77,	108,	122,	37,	60,	66,	121,	42,	51,	126,
080...089:	117,	114,	4,	90,	43,	52,	53,	113,	120,	72,
090...099:	16,	49,	7,	79,	119,	61,	22,	84,	9,	97,
100...109:	91,	15,	21,	24,	46,	39,	93,	105,	65,	70,
110...113:	125,	99,	17,	123,						

The hopping sequence generation algorithm is represented diagrammatically in figure 6.

This algorithm applies also to COMPACT and EC-GSM-IoT, whereby the parameters T1, T2 and T3 shall be calculated from FN.

In CTS, the general structure of the hopping sequence generation algorithm is shown in figure 6a, with the example of vector  $\underline{a} = (a_0, a_1, a_2, a_3) = (5, 8, 2, 11)$  and  $NF = 9$ . It consists of a 16 bit linear feedback shift register and two counters. The shift register in the CTS-FP shall be initialized with a random number which shall not be zero. The counter TFHC1 counts modulo NF the number of TDMA frames. The overflow of this counter causes a shift in the shift register. The counter TFHC2 counts modulo NF the number of shifts.

The elements which are used from the shift register to generate the codeword are defined by the vector  $\underline{a}$ . The codeword is built using a modulo 2 addition of these elements and the elements of vector  $\underline{v}$ . Before mapping the codeword into a sequence, the value of the counter TFHC2 is added modulo NF. The mapping is done by a modulo NF addition to the base sequence  $\underline{c}$ . This results in a sequence containing NF elements, each element representing one frequency index in the TFH list. The value of counter TFHC1 points to the current frequency index to use.

## 6.2.4 Specific cases

On the RFCH carrying a BCCH (C0), frequency hopping is not permitted on any timeslot supporting a BCCH according to table 3 of clause 7. A non-hopping radio frequency channel sequence is characterized by a mobile allocation consisting of only one radio frequency channel, i.e. with  $N=1$ ,  $MAIO=0$ . In this instance sequence generation is unaffected by the value of the value HSN.

For COMPACT, frequency hopping is not permitted on CPBCCH or CPCCCH for a specific amount of  $N\_CCCH\_NH$  blocks according to the ordered list described in subclause 6.3.2.1. If CPCCCH is defined as frequency hopping, those blocks use  $MAI = MAIO$ .

For COMPACT, on other frequency hopping channels, the reduced MA and MAIO\_2 shall be used for a specific amount of  $N\_CCCH\_NH$  blocks according to the ordered list described in subclause 6.3.2.1.

For COMPACT, in case the optional information elements reduced MA and MAIO\_2 are not present in the assignment message and the MA and MAIO information elements are present in the assignment message, then the MS shall hop in all allocated time slots according to the MA and MAIO.

## 6.2.5 Change in the frequency allocation of a base transceiver station

The consequence of adding or removing a number of radio frequency channels in a base transceiver station is a modification of the cell allocation (CA) and the mobile allocation (MA). In order to achieve this without disruption to mobile stations with currently assigned channels it is necessary to send a message to all mobiles with assigned channels. The message, as defined in 3GPP TS 44.018, will contain a new cell allocation (if necessary), mobile allocation and a time (in the form of a TDMA frame number) at which the change is to occur. A new cell allocation may not be necessary if channels are only being removed, and not added.

## 6.2.6 Frequency assignment in CTS

The CTSBCH (CTSBCH-FB and CTSBCH-SB) shall always be mapped on the CTSBCH RF channel (designated as C0 in table 8 of clause 7).

The CTSPCH, CTSARCH and CTSAGCH shall be mapped on the predefined set of carriers called TFH carrier list (designated by C0... Cn in Clause 7 Table 8) by the CTS frequency hopping algorithm specified in subclauses 6.2.2 and 6.2.3. However, the CTSARCH and CTSAGCH shall be mapped on the CTSBCH RF channel for the specific case of the non-hopping access procedure specified in 3GPP TS 44.056; the block TDMA frame mapping for these exceptions is specified in clause 7 table 8. The methods for the determination of the CTSBCH RF channel and the TFH carrier list are defined in 3GPP TS 45.056.

The TCH, FACCH and SACCH used for a CTS dedicated connection shall always be mapped on the TFH carrier list (C0..Cn) by the CTS frequency hopping algorithm. However, one exception is specified in the case of the CTS enrolment and attachment of a CTS-MS (see 3GPP TS 44.056), where a non-hopping access procedure is used; in these particular cases, the dedicated connection shall be used in non-hopping mode and the TCH, FACCH and SACCH shall be mapped on the CTSBCH RF channel (C0).

## 6.2.7 Mapping restrictions in downlink multi-carrier configurations

In DLMC configurations, restrictions of the mapping in frequency of logical channels onto physical channels may apply. The restrictions apply on a radio block basis to the carriers that are not selected. In case one or more of the assigned carriers belong to a group of selected carriers in a certain radio block period, the mobile shall monitor the assigned PDCHs on these carriers.

Which carriers that are selected is determined in each radio block period. I.e. all carriers where PDCHs are assigned during the radio block period are included in the carrier selection method. The carrier selection method is thus independent on the number of PDCHs assigned to any given carrier.

Whether or not any restrictions apply is dependent on the maximum DLMC carrier frequency spacing supported by the mobile station (see 3GPP TS 45.005) and the ARFCNs used by the assigned carriers during a given radio block period.

The method that determines which carriers belong to the group of selected carriers is defined below. All carriers with assigned numbers (see 3GPP TS 44.060) in the returned interval, *selected\_min* to *selected\_max*, belong to the group of selected carriers in the applicable radio block period.

In case carriers are assigned in two frequency bands, the method applies separately to each frequency band.

In case of non-contiguous intra-band reception, the method shall be first called with  $2 * \textit{max\_sep}$  as the last argument to check if all carriers can be received. If this is the case, nothing more needs to be done. Otherwise the method shall be called twice with *max\_sep* as the last argument, excluding the carriers selected by the first call (by different *arfcn* and *num\_carriers* parameters) in the second call.

The method is exemplified in Annex F.

```
CARRIER_SELECTION (arfcn, num_tdma_frames, num_carriers, max_sep)
selected_min = selected_max = anchor = 1
while anchor <= num_carriers
  current_min = current_max = anchor
  for i = 1 to num_tdma_frames
    min_arfcn[i] = max_arfcn[i] = arfcn[i][anchor]
  for candidate = anchor + 1 to num_carriers
    for i = 1 to num_tdma_frames
      if max(max_arfcn[i], arfcn[i][candidate]) - min(min_arfcn[i], arfcn[i][candidate]) > max_sep
        i = num_tdma_frames + 1
        break
```

```

if i == num_tdma_frames
for j = 1 to num_tdma_frames
min_arfcn[j] = min(min_arfcn[j], arfcn[j][candidate])
max_arfcn[j] = max(max_arfcn[j], arfcn[j][candidate])
current_max = current_max + 1
else
break
if current_max - current_min > selected_max - selected_min
selected_min = current_min
selected_max = current_max
anchor = candidate
return (selected_min, selected_max)

```

where:

- arfcn[1..num\_tdma\_frames][1..num\_carriers]: Two-dimensional vector containing the ARFCNs for all carriers subject to selection in each TDMA frame. The carriers are ordered according to the assigned carrier number (see 3GPP TS 44.060) with the lowest numbered carrier in arfcn[1..num\_tdma\_frames][1], and the highest numbered carrier in arfcn[1..num\_tdma\_frames][num\_carriers].
- num\_tdma\_frames: Number of TDMA frames per radio block period, 4 in case of BTTI mode, 2 in case of RTTI mode.
- num\_carriers: Number of carriers where PDCHs are assigned in a DLMC configuration.
- max\_sep: Maximum DLMC carrier frequency spacing supported by the MS (see 3GPP TS 45.005).

## 6.3 Mapping in time of logical channels onto physical channels

### 6.3.1 Mapping in time of circuit switched logical channels onto physical channels

#### 6.3.1.1 General

The mapping in time of circuit switched logical channels is defined in the tables of clause 7, which also defines the relationship of the air interface frames to the multiframe.

If assigned to a mobile station indicating support for VAMOS (see 3GPP TS 24.008), the traffic channel and its associated control channels shall be mapped as described in the table below:

**Table 6.3-1. Mapping of traffic and associated control channels onto TDMA frames for VAMOS mobiles.**

VAMOS mobile support level	Assigned TSC set	Mapping of traffic and associated control channels on to TDMA frames
VAMOS I	TSC set 1, 2, 3 or 4	Table 1 in clause 7
VAMOS II/III	TSC set 1 or 3	Table 1 in clause 7
VAMOS II/III	TSC set 2 or 4	Table 1a in clause 7
NOTE: The use of TSC set 3 and TSC set 4 is only applicable for mobile stations indicating support for Extended TSC sets, see 3GPP TS 24.008.		

#### 6.3.1.2 Key to the mapping table of clause 7

The following relates to the tables of clause 7. The columns headed:

- i) "Channel designation" gives the precise acronym for the channel to which the mapping applies.
- ii) "Sub-channel number" identifies the particular sub-channel being defined where a basic physical channel supports more than one channel of this type.

- iii) "Direction" defines whether the mapping given applies identically to downlink and uplink (D&U), or to downlink (D) or uplink (U) only.
- iv) "Allowable timeslots assignments" defines whether the channel can be supported on, or assigned to, any of the timeslots, or only on specific timeslots.
- v) "Allowable RF channel assignments" defines whether the channel can use any or all of the radio frequency channels in the cell allocation (CA), or only the BCCH carrier (C0). It should be noted that any allocated channel C<sub>x</sub> within CA could be any radio frequency channel, and that no ordering of radio frequency channel number is implied. For example, allocated channel C0 need not have the lowest radio frequency channel number of the allocation.
- vi) "Burst type" defines which type of burst as defined in clause 5.2 is to be used for the physical channel.
- vii) "Repeat length in TDMA frames" defines how many TDMA frames occur before the mapping for the interleaved blocks repeats itself e.g. 51.
- viii) "Interleaved block TDMA frame mapping" defines, within the parentheses, the TDMA frames used by each interleaved block (e.g. 0..3). The numbers given equate to the TDMA frame number (FN) modulo the number of TDMA frames per repeat length; Therefore, the frame is utilized when:

TDMA frame mapping number = (FN)mod repeat length given

Where there is more than one block shown, each block is given a separate designation e.g. B0, B1. Where diagonal interleaving is employed then all of the TDMA frames included in the block are given, and hence the same TDMA frame number can appear more than once (see 3GPP TS 45.003). Also, for E-TCH/F28.8, E-TCH/F32.0 and E-TCH/F43.2, the same frame number appears for the inband signalling message and for several interleaved blocks. It should be noted that the frame mapping for the SACCH/T channel differs according to the timeslot assigned in order to lower the peak processing requirements of the BSS.

### 6.3.1.3 Mapping of BCCH data

In order to facilitate the MS operation, it is necessary to transmit some System Information messages in defined multiframes and defined blocks within one multiframe, as follows (where  $TC = (FN \text{ DIV } 51) \text{ mod } (8)$ ). Also for some System Information messages, the position where they are transmitted is contained in other System Information messages:

**Table 6.3-2. System Information messages in defined multiframes and defined blocks within one multiframe.**

System Information Message	Sent when TC =	Allocation
Type 1	0	BCCH Norm
Type 2	1	BCCH Norm
Type 2 bis	5	BCCH Norm
Type 2 ter	5 or 4	BCCH Norm
Type 2 quater	5 or 4	BCCH Norm
	or	
	5	BCCH Ext
Type 2n	4	BCCH Norm
	or	
	4	BCCH Ext
Type 3	2 and 6	BCCH Norm
Type 4	3 and 7	BCCH Norm
Type 7	7	BCCH Ext
Type 8	3	BCCH Ext
Type 9	4	BCCH Norm
Type 13	4	BCCH norm
	or	
	0	BCCH Ext
Type 13 alt	4	BCCH norm
	or	
	0	BCCH Ext
Type 15	4	BCCH Norm
	or	
	1	BCCH Ext
Type 16	6	BCCH Ext
Type 17	2	BCCH Ext
Type 18	Not fixed	Not fixed
Type 19	Not Fixed	Not Fixed
Type 20	Not fixed	Not fixed
Type 21	4	BCCH Norm
	or	
	4	BCCH Ext
Type 22	2 and 6	BCCH Ext
Type 23	1 or 5	BCCH Ext

This subclause defines requirements on minimum scheduling: the network may send any System Information message when sending of a specific System Information message is not required. The following rules apply:

- i) BCCH Ext may share the resource with PCH and AGCH (see subclause 6.5.1).
- ii) System Information Type 1 needs to be sent if frequency hopping is in use or when the NCH is present in a cell. If the MS finds another message on BCCH Norm when TC = 0, it can assume that System Information Type 1 is not in use.
- iii) System information type 2 bis or 2 ter messages are sent if needed, as determined by the system operator. If only one of them is needed, it is sent when TC = 5. If both are needed, 2bis is sent when TC = 5 and 2ter is sent at least once within any of 4 consecutive occurrences of TC = 4. A SI 2 message will be sent at least every time TC = 1. System information type 2 quater is sent if needed, as determined by the system operator. If sent on BCCH Norm, it shall be sent when TC = 5 if neither of 2bis and 2ter are used, otherwise it shall be sent at least once within any of 4 consecutive occurrences of TC = 4. If sent on BCCH Ext, it is sent at least once within any of 4 consecutive occurrences of TC = 5.
- iv) The definitions of BCCH Norm and BCCH Ext are given in table 3 of clause 7.
- v) Use of System Information type 7 and 8 is not always necessary. It is necessary if System Information type 4 does not contain all information needed for cell selection and reselection.
- vi) System Information type 9 is sent in those blocks with TC = 4 which are specified in system information type 3 as defined in 3GPP TS 44.018.
- vii) System Information type 13 is only related to the GPRS service. System Information Type 13 need only be sent if GPRS support is indicated in one or more of System Information Type 3 or 4 or 7 or 8 messages. These messages also indicate if the message is sent on the BCCH Norm or if the message is transmitted on the BCCH

Ext. In the case that the message is sent on the BCCH Norm, it is sent at least once within any of 4 consecutive occurrences of TC=4.

- viii) System Information type 16 and 17 are only related to the SoLSA service. They should not be sent in a cell where network sharing is used (see rule xv).
- ix) System Information type 18 and 20 are sent in order to transmit non-GSM broadcast information. The frequency with which they are sent is determined by the system operator. System Information type 9 identifies the scheduling of System Information type 18 and 20 messages.
- x) System Information Type 19 is sent if COMPACT neighbours exist. If System Information Type 19 is present, then its scheduling shall be indicated in System Information Type 9.
- xi) System Information Type 15 is broadcast if dynamic ARFCN mapping is used in the PLMN. If sent on BCCH Norm, it is sent at least once within any of 4 consecutive occurrences of TC = 4. If sent on BCCH Ext, it is sent at least once within any of 4 consecutive occurrences of TC = 1.
- xii) System Information type 13 alt is only related to the GERAN *Iu mode*. System Information Type 13 alt need only be sent if GERAN *Iu mode* support is indicated in one or more of System Information Type 3 or 4 or 7 or 8 messages and SI 13 is not broadcast. These messages also indicate if the message is sent on the BCCH Norm or if the message is transmitted on the BCCH Ext. In the case that the message is sent on the BCCH Norm, it is sent at least once within any of 4 consecutive occurrences of TC = 4.
- xiii) System Information Type 2n is optionally sent on BCCH Norm or BCCH Ext if needed, as determined by the system operator. In the case that the message is sent on the BCCH Norm, it is sent at least once within any of 4 consecutive occurrences of TC = 4. If the message is sent on BCCH Ext, it is sent at least once within any of 2 consecutive occurrences of TC = 4.
- xiv) System Information Type 21 is optionally sent on BCCH Norm or BCCH Ext, as determined by the system operator. If Extended Access Barring is in use in the cell then this message is sent at least once within any of 4 consecutive occurrences of TC = 4 regardless if it is sent on BCCH Norm or BCCH Ext. If BCCH Ext is used in a cell then this message shall only be sent on BCCH Ext.
- xv) System Information Type 22 is sent if network sharing is in use in the cell. It should not be sent in a cell where SoLSA is used (see rule viii). System Information Type 22 instances shall be sent on BCCH Ext within any occurrence of TC =2 and TC=6.
- xvi) System Information Type 23 is sent if network sharing is in use in the cell, according to System Information Type 22 indication. System Information Type 23 instances shall be sent on BCCH Ext at least twice within any of 4 consecutive occurrences of either TC=1 or TC=5.

All the allowable timeslot assignments in a frame (see table 3 of clause 7) shall contain the same information.

### 6.3.1.4 Mapping of SID Frames

When the DTX mode of operation is active, it is required to transmit Silence Descriptor (SID) information, or equivalent dummy information, during the SACCH/T block period (104 TDMA frames). As the SID frames do not constitute a logical channel and their use is specific to DTX operation, the mapping of SID frames onto the TDMA frames is specified in 3GPP TS 45.008.

## 6.3.2 Mapping in time of packet logical channels onto physical channels

### 6.3.2.1 General

A physical channel allocated to carry packet logical channels is called a packet data channel (PDCH). A PDCH shall carry packet logical channels only.

In RTTI configuration, physical channels are paired, forming PDCH-pairs. The two physical channels shall have the same parameters (see subclause 5.6.3) except for the timeslot number (TN). The two PDCHs constituting a PDCH-pair shall be located on the same carrier. The two PDCHs constituting a PDCH-pair need not be contiguous. In each direction, physical channels shall be assigned so that PDCH-pairs do not partially overlap.

On a given PDCH, PDTCHs in both BTTI configuration and RTTI configuration (assigned to different MSs) may be carried. Alternatively, both PDCHs forming a PDCH-pair may be assigned to only carry PDTCHs in RTTI configuration.

Packet switched logical channels are mapped dynamically onto a 52-multiframe.

- For a PDCH/F in BTTI configuration the 52-multiframe consists of 12 blocks of 4 consecutive frames, 2 idle frames and 2 frames used for the PTCCH (see 3GPP TS 45.010), as shown in Figure 9. Table 6 in clause 7, indicates the frame numbers for each of the blocks (B0...B11) transmitted in the multiframe. The ordered list of block is defined as B0, B6, B3, B9, B1, B7, B4, B10, B2, B8, B5, B11.
- For PDCH/H, the 52-multiframe consists of 6 blocks of 4 frames each, and two idle frames. Table 6 in clause 7 indicates the frame numbers for each of the blocks (B0...B5) transmitted in the multiframe.
- For a PDCH-pair in RTTI configuration the 52-multiframe consists of 24 RTTI blocks of 2 consecutive frames, plus 2 idle frames and 2 frames used for the PTCCH (see 3GPP TS 45.010) on each PDCH of the PDCH-pair, as shown in Figure 9a. Table 6 in clause 7 indicates the frame numbers for each of the 24 RTTI blocks (B0<sub>a</sub>, B0<sub>b</sub>, ...B11<sub>a</sub>, B11<sub>b</sub>) transmitted in the 52-multiframe.
- For a PDCH/F, when in EC operation, the 52-multiframe consists of 12 BTTI blocks of 4 consecutive frames, and 4 idle frames, as shown in Figure 9b. In case blind physical layer transmissions are used, multiple BTTI blocks constitute the block that is mapped onto the physical channel, see Figure 9b. For an uplink EC TBF assigned two PDCHs, compact burst mapping shall be used (see 3GPP TS 45.001). In this case, the block that is mapped onto the physical channel is not an aggregate of BTTI blocks constructed using bursts from 4 consecutive TDMA frames. Table 6a in clause 7 indicates the frame numbers of each of the blocks depending on the downlink Coverage Class or uplink Coverage Class respectively.
- Depending on the intended coverage range, EC-PDTCH/F and EC-PACCH/F are defined for different Coverage Classes (CCs), see 3GPP TS 43.064. Depending on the CC and the number of PDCHs assigned for EC operation (see 3GPP 44.018 and 3GPP 44.060) one EC-PDTCH/F and/or EC-PACCH/F are mapped onto different number of PDCHs according to:
  - CC1: 1 PDCH
  - CC2, CC3, CC4: 4 PDCHs or 2 PDCHs

The PDCHs that an EC-PDTCH/F and/or EC-PACCH/F are mapped to are contiguous, see Table 6a in clause 7.

A block allocated to a given logical channel comprises one radio block, or in the case of uplink only, 4 random access bursts. The type of channel may vary on a block-by-block basis. In case of EC operation a block allocated to an EC-channel can consist of blind physical layer transmissions of a radio block. The number of blind physical layer transmissions is dependent on the assigned Coverage Class.

In the downlink direction, the logical channel type shall be indicated by the message type contained in the block header part for GPRS, or indicated by Stealing Flags for EGPRS and EGPRS2, or detected by the MS in case of EC operation.

In the uplink part for channels other than (EC-)PACCH transmitted as access bursts or PRACH, or CPRACH or (EC-)RACH, the logical channel type shall be indicated by the message type contained in the block header part for GPRS, or indicated by Stealing Flags for EGPRS and EGPRS2, or known by the BTS in case of EC operation. For (EC-)PACCH transmitted as access bursts, the logical channel type is indicated by the corresponding polling message on the downlink (see 3GPP TS 44.060). For the PRACH or CPRACH case the logical channel type is indicated by the USF (see 3GPP TS 44.060), set on the downlink on a block by block basis.

For COMPACT, timeslot mapping and rotation of the control channels is used such that control channels belonging to a serving time group are rotated over odd timeslot numbers as follows: 7, 5, 3, 1, 7, 5 ... . The rotation occurs between frame numbers (FN) mod 52 = 3 and 4. The mapping of the control channels on timeslot numbers is defined by the following formula:

- for  $0 \leq \text{FN mod } 52 \leq 3$ ,  $\text{TN} = ((6 \times ((\text{FN div } 52) \text{ mod } 4)) + 1 + (2 \times \text{TG})) \text{ mod } 8$ ;
- for  $4 \leq \text{FN mod } 52 \leq 51$ ,  $\text{TN} = ((6 \times ((\text{FN div } 52) \text{ mod } 4)) + 7 + (2 \times \text{TG})) \text{ mod } 8$ .

Packet switched logical channels PDTCH, PACCH, and PTCCH are never rotated.



## 6.3.2.2 Mapping of the uplink channels

### 6.3.2.2.1 Mapping of (EC-)PDTCH/U and (EC-)PACCH/U

#### 6.3.2.2.1.1 BTTI configuration

The PDCH's where the MS may expect occurrence of its (EC-)PDTCH/U(s) or (EC-)PACCH/U for a mobile originated transfer is indicated in resource assignment messages (see 3GPP TS 44.060 and 3GPP 44.018). (EC-)PACCH/U shall be allocated respecting the resources assigned to the MS and the MS multislot class. For each PDCH assigned to the MS, an Uplink State Flag (R0... R7) is given to the MS. An exception is when using Fixed Uplink Allocation where the Uplink State Flag is not used to allocate resources, and hence no Uplink State Flag is given to the MS.

In case of USF based allocation, the occurrence of the PDTCH/U and/or the PACCH/U at given block(s) B<sub>x</sub> (where B<sub>x</sub> = B<sub>0</sub>...B<sub>n</sub>; n=5 for the PDTCH/HU and n=11 for the PDTCH/FU) in the 52-multiframe structure for a given MS on a given PDCH shall be indicated by the value of the Uplink State Flag (USF) contained in the header of the preceding block transmitted in the downlink of the same PDCH (or in the case of shifted USF on the downlink of a PDCH with a relationship to the uplink PDCH as defined in 3GPP TS 44.060), that is to say B(x-1) in the same multiframe if x≥1 or B(n) in the previous multiframe if x=0. If the USF in block B(x-1) indicates that block B(x) shall be used by an MS for which the USF\_GRANULARITY is set to 1 (corresponding to 4 blocks) in the last assignment message, that MS shall also use the three following blocks. The USF corresponding to the last three blocks shall be set to an unused value. The MS may transmit a PDTCH block or a PACCH block on any of the uplink blocks used by the MS. The occurrence of the PACCH/U associated to a PDTCH/D shall be indicated by the network by polling the MS (see 3GPP TS 44.060).

In case of Fixed Uplink Allocation, the occurrence of the EC-PDTCH/U at given block(s) in the 52-multiframe structure for a given MS on given PDCH(s) shall be indicated by an EC Immediate Assignment Type 1, EC-Immediate Assignment Type 2, EC Packet Uplink Ack/Nack or EC Packet Uplink Assignment message. The number of blocks available per 52-multiframe depends on the uplink Coverage Class and the number of PDCHs assigned for EC operation as shown in table 6.3-2. The mapping of each block onto the 52-multiframe is shown in table 6a, and illustrated in figure 9b, figure 9c, figure 9d and figure 9e.

**Table 6.3-3: Blocks per 52-multiframe depending on uplink Coverage Class for EC-GSM-IoT**

Uplink Coverage Class	Number of PDCH assigned	Number of blocks per 52-multiframe
1	1	12
2	4	12
3	4	6
4	4	3
5	4	1
2	2	6
3	2	3
4	2	3/2 <sup>1</sup>
5	2	1/22

Note 1: This corresponds to 3 blocks per 2\*52-multiframes.  
 Note 2: This corresponds to 1 block per 2\*52-multiframes.

The occurrence of the EC-PACCH/U associated with EC-PDTCH/D shall be indicated by the network by polling the MS (see 3GPP TS 44.060).

NOTE 1: This subclause specifies how the network shall signal that the MS is allowed to use the uplink. The operation of the MS is specified in 3GPP TS 44.060. In particular cases of extended dynamic allocation or exclusive allocation, the MS may not need to monitor the USF on all the downlink timeslots corresponding to the assigned uplink PDCHs. In case of Fixed Uplink Allocation the MS shall not monitor the USF.

NOTE 2: The PDCH/HU is only assigned in exclusive allocation (see 3GPP TS 44.060).

NOTE 3: A MS using packet uplink traffic channels mapped to the same physical channel than an uplink PCCCH in extended dynamic allocation MAC mode is not required to check if allocated uplink PDTCH/U or PACCH/U blocks also belong to the PRACH.

In a dual carrier or a DLMC configuration, the uplink block(s) shall be allocated on the corresponding physical channel on which the USF or poll (see 3GPP TS 44.060) is received. Uplink blocks shall not be allocated on physical channels having different frequency domain descriptions (see subclause 5.4) simultaneously in the same block period.

For COMPACT, USF\_GRANULARITY should be set to 0 (corresponding to 1 block) for dynamic allocation for the following cases:

- i) for odd timeslot numbers (TN) 1, 3, 5, and 7 in nominal and large cells;
- ii) for even timeslot numbers (TN) 0, 2, 4, and 6 in large cells.

#### 6.3.2.2.1.2 RTTI configuration

The PDCH-pairs where the MS may expect occurrence of its PDTCH/U(s) or PACCH/U for a mobile originated transfer are indicated in resource assignment messages (see 3GPP TS 44.060). PACCH/U shall be allocated respecting the resources assigned to the MS and the MS multislot class.

For each PDCH-pair assigned to the MS, one or two USFs (R0... R7) are given to the MS. For each assigned uplink PDCH-pair the network may signal in resource assignment messages a "corresponding downlink PDCH-pair" where the USF is monitored. The timeslot numbers of the PDCHs constituting the corresponding downlink PDCH-pair may be different from those of the PDCHs constituting the uplink PDCH-pair. If no indication is provided, the corresponding downlink PDCH-pair shall be the one with the same timeslot numbers as the uplink PDCH-pair.

For an assigned uplink PDCH-pair, for the transmission of the USF the network can use one of two modes:

- BTTI USF mode: USFs are sent in a basic radio block period, i.e. a USF is mapped on four bursts transmitted on one of the PDCHs of a downlink PDCH-pair during four consecutive TDMA frames;
- RTTI USF mode: a USF is sent in a reduced radio block period, i.e. a USF is mapped on four bursts transmitted on both PDCHs of a downlink PDCH-pair during two consecutive TDMA frames.

The network shall signal the USF mode in the resource assignment messages (see 3GPP TS 44.060). The USF mode shall be the same for all the uplink PDCH-pairs assigned to one mobile station. Also, on a given downlink PDCH-pair, all USFs shall be sent with the same USF mode.

If the BTTI USF mode is used, for each PDCH-pair assigned to the MS the network shall give two USFs (R0... R7) to the MS, one for each PDCH of the corresponding downlink PDCH-pair. If the RTTI USF mode is used, for each PDCH-pair assigned the network shall give to the MS one Uplink State Flag (R0... R7) to the MS.

When a given downlink PDCH is configured to provide USFs for PDTCHs operating in RTTI configuration (as part of a corresponding downlink PDCH-pair) and PDTCHs operating in BTTI configuration, the BTTI USF mode shall be used on both PDCHs of the corresponding downlink PDCH-pair to schedule uplink blocks for mobile stations using RTTI configuration. Additionally, if any of the downlink PDTCHs mapped onto either PDCH of a corresponding PDCH-pair operates in BTTI configuration, the BTTI USF mode shall be used on both PDCHs. In this case, if  $x \geq 1$ , the first uplink RTTI radio block  $B_{x_a}$  shall be allocated by the USF contained in block  $B(x-1)$  of the downlink PDCH having the lowest TN and the second uplink RTTI radio block  $B_{x_b}$  shall be allocated by the USF contained in block  $B(x-1)$  of the highest numbered PDCH TN of the "corresponding downlink PDCH-pair" to the uplink PDCH-pair (see Figure 9a and 3GPP TS 44.060). If  $x=0$  the corresponding USFs will be carried within block B11 of the previous 52-multiframe. In case of dual carrier or a DLMC configuration in the downlink, this same relationship between USFs and uplink RTTI radio blocks shall apply. If the USF\_GRANULARITY is set to 1 (corresponding to 4 blocks) in the last assignment message, the MS shall also use the next three consecutive RTTI radio blocks of sub-index a or sub-index b (according to the PDCH in which the USF was received), see 3GPP TS 44.060. The USF corresponding to the last three blocks shall be set to an unused value.

When on a downlink PDCH belonging to a PDCH-pair a USF is sent scheduling an uplink block belonging to an MS in BTTI configuration, the USF on the other PDCH of the "corresponding PDCH-pair" shall also schedule an uplink block belonging to an MS in BTTI configuration.

When both PDCHs of a corresponding downlink PDCH-pair are configured to provide USFs for uplink PDTCHs all operating in RTTI configuration, and when all the downlink PDTCHs mapped onto both PDCHs operate in RTTI configuration, the RTTI USF mode shall be used on both PDCHs. In this case, if  $x \geq 1$ , the uplink RTTI radio block  $B_{x_a}$  shall be allocated by the USF contained in RTTI block  $B(x-1)_b$  and uplink RTTI radio block  $B_{x_b}$  shall be allocated by the USF contained in RTTI block  $B_{x_a}$  of the "corresponding downlink PDCH-pair" to the uplink PDCH-pair (see Figure 9a and 3GPP TS 44.060). If  $x=0$  the USFs will be carried within RTTI block B11<sub>b</sub> of the previous 52-multiframe and

$B0_a$  respectively. If the USF\_GRANULARITY is set to 1 (corresponding to 4 blocks) in the last assignment message, the MS shall also use the next three consecutive RTTI radio blocks, see 3GPP TS 44.060. The USF corresponding to the last three blocks shall be set to an unused value.

The MS may transmit a PDTCH block or a PACCH block on any of the uplink blocks allocated to the MS. The occurrence of the PACCH/U associated to a PDTCH/D shall be indicated by the network by polling the MS (see 3GPP TS 44.060).

#### 6.3.2.2.2 Mapping of the Packet Timing Advance Control Channel (PTCCH/U)

The PDCH carrying the PTCCH/U of one MS is defined in the resource assignment message (see 3GPP TS 44.060). PTCCH/U shall be mapped to one of the time slots where PDTCH(s) are allocated to the MS. PTCCH/U shall be allocated respecting the resources assigned to the MS and the MS multislot class. An MS shall be allocated a sub-channel of the PTCCH/U (0...15) as defined in table 6 of clause 7, where the sub-channel number is equal to the Timing Advance Index (TAI) indicated in the resource allocation message (see 3GPP TS 44.060).

In a dual carrier or a DLMC configuration, an MS shall be assigned a PTCCH/U sub-channel on a physical channel having one frequency domain description (see subclause 5.4) only.

In RTTI configuration, an MS shall be assigned a PTCCH/U on only one of the physical channels comprising an uplink PDCH-pair (see subclause 6.3.2.1).

#### 6.3.2.2.3 Mapping of the uplink PCCCH i.e. PRACH

The mapping of the PRACH is defined in table 6 of clause 7, where the possible blocks are indicated. The PRACH is dynamically allocated in groups of four PRACH blocks  $B_y$  ( $y=4x+i$ ,  $i=0, \dots, 3$ ) corresponding to one PDCH block  $B_x$  ( $x=0, \dots, 11$ ), indicated by USF=FREE in the same way as defined for PDTCH/U (see subclause 6.3.2.2.1).

Optionally, a subset of the blocks  $B_x$  can be allocated to PRACH in a fixed way. The number of allocated blocks is indicated by the parameter BS\_PRACH\_BLKs broadcast on the PBCCH, where BS\_PRACH\_BLKs=0...12. The blocks are allocated according to the ordered list defined in subclause 6.3.2.1. The blocks shall also be indicated by the USF=FREE. The MS may choose to use the BS\_PRACH\_BLKs or USF to determine the fixed allocated part of PRACH.

#### 6.3.2.2.3a Mapping of the COMPACT uplink CPCCCH i.e. CPRACH

The CPRACH is dynamically or fixed allocated in the same way as defined for PRACH (see subclause 6.3.2.2.3). USF should be set equal to FREE for downlink block  $B0$  on a serving time group when 4 time groups are assigned. Uplink blocks (other than block  $B1$  on a serving time group) that are preceded by CPBCCH and CPCCCH blocks should be prioritized for use as CPRACH.

See Annex D for examples based on sixteen prioritized CPRACH blocks.

#### 6.3.2.2.4 Mapping of the MBMS uplink MPRACH

The mapping of the MPRACH is defined in table 6 of clause 7, where the possible blocks are indicated. The MPRACH is dynamically allocated in groups of four MPRACH blocks  $B_y$  ( $y=4x+i$ ,  $i=0, \dots, 3$ ) corresponding to one PDCH block  $B_x$  ( $x=0, \dots, 11$ ), indicated by a value of the USF, in the same way as defined for PDTCH/U (see subclause 6.3.2.2.1). The value of the USF is signalled in the MBMS notification message (see 3GPP TS 44.060).

#### 6.3.2.2.5 Void

#### 6.3.2.2.6 Mapping of Overlaid CDMA sub channels

In case overlaid CDMA is used on dedicated channels (EC-PDTCH and EC-PACCH), see 3GPP TS 43.064 [6], up to four MS can be multiplexed on the same physical resource, simultaneously transmitting, using different orthogonal codes assigned by the network if four PDCHs are assigned for EC operation, see 3GPP 44.018 [10] and 3GPP TS 44.060 [11]. Else if two PDCHs are assigned for EC operation, two MS can be multiplexed on the same physical resource. The codes are applied per burst over the assigned PDCHs for EC-PDTCH and EC-PACCH in each TDMA frame from the lowest to the highest numbered assigned TN, according to Table 6.3-3, and are only applied in case blind physical layer transmissions are used (i.e. for CC2, CC3 and CC4). The code value is either 0 or 1. In case 0 is

used, the burst is transmitted as if no code was applied. In case 1 is used, the whole burst is shifted in phase by  $\pi$  radians, see 3GPP TS 45.004 [14]. Since the code is applied over the blind physical layer transmissions within the TDMA frame, and CC2, CC3, CC4 all map to four or two PDCHs in a TDMA frame, there is no restriction on the pairing of MS on the same physical resources, of different Coverage Classes, as long as blind physical layer transmissions are used (CC2, CC3 and CC4) and the same number of PDCHs (i.e. four or two) are assigned for these MS assigned on those resources. Overlaid CDMA is only applied for transmissions on the uplink, i.e. for EC-PACCH/U and EC-PDTCH/U.

Overlaid CDMA is also specified for EC-RACH in CC5 using EDAB in the 2 TS EC-RACH format with TS7, see sub-clause 5.2.11. The first burst (burst with equal size to the active part of the normal burst) and the second burst (burst with equal size to the active part of the access burst) are transmitted using the code sequence '01' according to Table 6.3-3.

NOTE: This enables the network to segregate transmissions in CC4, using the 2 TS EC-RACH format without phase shift, from transmissions in CC5, since both transmissions use the same synchronization sequence TS7, see sub-clause 5.2.7.

**Table 6.3-4. Overlaid CDMA codes**

Overlaid CDMA code <sup>1</sup>	Code sequence <sup>2</sup>	Code sequence <sup>3</sup>
0	0000	00
1	0101	01 <sup>4</sup>
2	0011	-
3	0110	-
NOTE1: see 3GPP TS 44.060 [11]		
NOTE2: The first number in the sequence is applied to the lowest numbered assigned PDCH. The second number to the second lowest numbered assigned PDCH etc, in case four PDCHs are assigned for EC operation.		
NOTE 3: The first number in the sequence is applied to the lower numbered assigned PDCH and the second number to the higher numbered assigned PDCH. This code sequence is used if two PDCHs are assigned for EC operation.		
NOTE 4: The code sequence '01' applies also for EC-RACH for CC5 using EDAB in the 2 TS EC-RACH format, see sub-clause 5.2.11.		

### 6.3.2.3 Mapping of the downlink channels

#### 6.3.2.3.1 Mapping of the (EC-)PDTCH/D and (EC-)PACCH/D

The PDCH(s) in BTTI configuration or the PDCH-pair(s) in RTTI configuration where the MS may expect occurrence of its (EC-)PDTCH/D(s) for a mobile terminated transfer or its (EC-)PACCH/D, for both mobile originated and mobile terminated transfer, are indicated in resource assignment messages (see 3GPP TS 44.060). (EC-)PDTCH/D and (EC-)PACCH/D can be mapped dynamically on all blocks except those used for PBCCH (see subclause 6.3.2.3.3). The logical channel type shall be indicated in the block header for GPRS, it shall be indicated by Stealing Flags for EGPRS and EGPRS2, and it shall be detected by the MS in case of EC operation. The mobile owner of the (EC-)PDTCH/D or (EC-)PACCH/D shall be indicated by the TFI (Temporary Flow Identity) (see 3GPP TS 44.060).

For EC-PDTCH/D and EC-PACCH/D the number of blocks available per 52-multiframe depends on the downlink Coverage Class and the number of PDCHs assigned for EC operation, and is the same as for uplink shown in table 6.3-3.

If PDTCH/D is mapped on blocks, which may be used for PCCCH and where paging may appear, the network shall only use coding schemes CS-1 to CS-4.

NOTE: This restriction is needed to avoid the expiry of the downlink signalling counter (DSC) for non-EGPRS capable mobile stations in case the network uses MCS-1 to MCS-9. CS-1 should be favoured, as it provides the strongest error protection.

#### 6.3.2.3.2 Mapping of the PTCCH/D

The PTCCH/D is mapped as defined in table 6 of clause 7. The PTCCH/D carries signalling messages including timing advance information for MSs sharing the PTCCH/U on the same PDCH.

In a dual carrier or a DL/MC configuration, an MS shall be assigned a PTCCH/D channel on a physical channel having one frequency domain description (see subclause 5.4) only.

In RTTI configuration, an MS shall be assigned a PTCCH/D on only one of the physical channels comprising a downlink PDCH-pair (see subclause 6.3.2.1). When only an uplink PDTCH is assigned to the MS, the PTCCH shall be assigned on one of the PDCHs comprising the "corresponding downlink PDCH-pair" for the uplink PDTCH (see subclause 6.3.2.2.1.2).

### 6.3.2.3.3 Mapping of the PBCCH

The PBCCH is mapped onto one PDCH only, indicated in the BCCH. The PBCCH is mapped on BS\_PBCCH\_BLKs blocks (where  $1 \leq \text{BS\_PBCCH\_BLKS} \leq 4$ ) per multiframe, according to the ordered list described in subclause 6.3.2.1. The blocks allocated are specified in table 6 of clause 7. The parameter BS\_PBCCH\_BLKs is broadcast on PBCCH in block B0 (see subclause 3.3.2.4).

### 6.3.2.3.3a Mapping of the COMPACT CPBCCH

The CPBCCH is mapped onto a primary COMPACT carrier on the time group indicated by TG on CSCH (see subclause 3.3.2.2). This time group is known as the serving time group and rotates over odd timeslot numbers (see subclause 6.3.2.1). The CPBCCH is mapped on BS\_PBCCH\_BLKs blocks (where  $1 \leq \text{BS\_PBCCH\_BLKS} \leq 4$ ) per multiframe, according to the ordered list described in subclause 6.3.2.1. The blocks allocated are specified in table 9 of clause 7. The parameters BS\_PBCCH\_BLKs is broadcast on CPBCCH in block B0 (see subclause 3.3.2.4).

See Annex D for examples based on one CPBCCH block.

When USF=FREE in downlink block B0 on a serving time group, the CPBACH is allocated in uplink block B1 after timeslot rotation. When USF has any other value in downlink block B0 on a serving time group, the uplink allocation of B1 is valid for the same timeslot, irrespective of timeslot rotation.

### 6.3.2.3.3b Void

### 6.3.2.3.4 Mapping of the PCCCH

The PCCCH and its different logical channels (PAGCH, PPCH) can be mapped dynamically and are identified by the message header. The configuration is partly fixed by some parameters broadcast by the PBCCH and defined in subclause 3.3.2.4:

- a) BS\_PBCCH\_BLKs, that defines the number of PBCCH blocks per multiframe, according to the ordered list described in subclause 6.3.2.1, on the PDCH that carries PBCCH;
- b) BS\_PAG\_BLKs\_RES, that defines the number of blocks in addition to BS\_PBCCH\_BLKs, according to the ordered list described in subclause 6.3.2.1, where PPCH shall not occur on every PDCH that carries PCCCH.

PCCCH (except PPCH) can be mapped on all blocks except those used for PBCCH.

If PBCCH is allocated on timeslot  $k$ , PCCCHs shall be allocated only on timeslots  $n$  where  $n > k-4$  and  $0 \leq n \leq 7$  in order to provide time for the MS to switch from PBCCH to PCCCH.

### 6.3.2.3.4a Mapping of the COMPACT CPCCCH

The CPCCCH and its different logical channels (CPAGCH, CPPCH) can be mapped dynamically and are identified by the message header. The configuration is partly fixed by some parameters broadcast by the CPBCCH and defined in subclause 3.3.2.4:

- a) BS\_PBCCH\_BLKs, that defines the number of CPBCCH blocks per multiframe, according to the ordered list described in subclause 6.3.2.1, on the radio frequency channel that carries CPBCCH;
- b) BS\_PAG\_BLKs\_RES, that defines the number of blocks in addition to BS\_PBCCH\_BLKs, where CPPCH shall not occur on every radio frequency channel that carries CPCCCH. These blocks without CPPCH are allocated after CPPCH blocks according to the ordered list described in subclause 6.3.2.1.

CPCCCH (except CPPCH) can be mapped on all blocks except those used for CPBCCH.

For primary COMPACT carriers, CPCCCHs shall be allocated on the same time group as CPBCCCH. CPCCCHs on secondary COMPACT carrier(s) shall be allocated on same time group as for primary COMPACT carrier.

See Annex D for examples based on three CPCCCH blocks.

#### 6.3.2.3.4b Void

#### 6.3.2.4 Mapping of PBCCH data

In order to facilitate the MS operation, the network is required to transmit certain types of Packet System Information (PSI) messages in specific multiframes and specific PBCCH blocks within the multiframes. The occurrence of the PSI1 message is defined by  $TC = (FN \text{ DIV } 52) \bmod \text{PSI1\_REPEAT\_PERIOD}$ , where  $\text{PSI1\_REPEAT\_PERIOD}$  (range 1 - 16) is indicated in the SI13 message on BCCH, the PSI 1 message on PBCCH and, if present, in the Neighbour Cell parameters in PSI3 and PSI3bis messages sent on serving cell PBCCH.

The PSI1 message is transmitted at  $TC = 0$  according to rule i) and ii) below.

The PSI messages other than the PSI1 message are divided into two groups of PSI messages. One group of PSI messages is transmitted with a low repetition rate and a second group is transmitted with a high repetition rate.

The number of PSI message instances sent with high repetition rate is indicated by the parameter  $\text{PSI\_COUNT\_HR}$  (range 0 to 16) in the PSI1 message. The PSI messages in this group are sent according to rule iii) below.

The number of PSI message instances sent with low repetition rate is indicated by the parameter  $\text{PSI\_COUNT\_LR}$  (range 0 to 63) in the PSI1 message. The PSI messages in this group are sent according to rule iv) below.

The following rules apply:

- i) PSI1 shall be sent in block B0 when  $TC = 0$ ;
- ii) if the value of the parameter  $\text{BS\_PBCCH\_BLKS}$  is greater than 1, the PSI1 shall also be sent in block B6 when  $TC = 0$ ;
- iii) the PSI messages in the group sent with high repetition rate shall be sent in a sequence determined by the network and starting at  $TC = 0$ , using the PBCCH blocks within each multiframe, in the order of occurrence, which are not occupied according to rule i) or ii). The sequence of these PSI messages shall be repeated starting at each occurrence of  $TC = 0$ ;
- iv) the PSI messages in the group sent with low repetition rate shall be sent in a sequence determined by the network and continuously repeated, using the PBCCH blocks within each multiframe, in the order of occurrence, which are not occupied according to rules i) to iii). The sequence of these PSI messages shall be restarting at  $FN = 0$ .

If there are multiple instances of a particular type of PSI message (see 3GPP TS 44.060), they shall all be sent within same group of PSI messages according to either rule iii) or iv) above. They shall be sent in a single sequence in the ascending order of the message instance number of that type of PSI message.

The same PSI message shall not occur twice within the lists defined by  $\text{PSI\_COUNT\_LR}$  and  $\text{PSI\_COUNT\_HR}$

A full set of Packet System Information messages contains one consistent set of the messages included in  $\text{PSI\_COUNT\_LR}$  and one consistent set of the messages included in  $\text{PSI\_COUNT\_HR}$  plus the PSI1 message.

NOTE: The parameters  $\text{BS\_PBCCH\_BLKS}$  and  $\text{PSI1\_REPEAT\_PERIOD}$  shall be selected by the network such that all PSI message present in the cell can be sent according to rules i) to iv) above. It is the responsibility of the network to optimise the broadcast of the PSI messages so that the MS can find the important parameters for cell re-selection and access as fast as possible without unnecessary power consumption. The PSI mapping scheme information can be utilised by the MS to estimate the actual minimum cell reselection time.

#### 6.3.2.4a Mapping of COMPACT CPBCCCH data

See subclause 6.3.2.4, with the exception that the CPBCCCH is a stand-alone packet control channel for COMPACT.

## 6.3.2.4b Void

## 6.3.3 Mapping in time of CTS control channels onto physical channels

The mapping in time of CTS control channels is defined in table 8 of clause 7, which also defines the relationship of the air interface TDMA frames to the multiframe.

The timeslot assignment of the CTS control channel is defined hereafter.

## 6.3.3.1 CTSBCH timeslot assignment

For the CTSBCH, a procedure of timeslot shifting from one 52-multiframe to another is defined. The usage of this procedure is mandatory in CTS idle mode and optional in CTS dedicated mode. When the shifting procedure is not applied, the CTSBCH timeslot number shall be equal to the TNC broadcast in the current 52-multiframe CTSBCH-SB.

The following parameters are required for the timeslot shifting procedure.

Parameters broadcast in the CTSBCH-SB:

- a) TNI: initial timeslot number (0 to 7, 3 bits), defined by the three LSBs (BN3, BN2, BN1) of the FPBI (specified in 3GPP TS 23.003);
- b) TNSCN: timeslot number series couple number (0 to 31, 5 bits), defined by the 5 bits (BN8, ..., BN4) of the FPBI. Defines the couple of timeslot number circular series ( $TNS_{TNSCN,0}$ ,  $TNS_{TNSCN,1}$ ) to be used to form the timeslot shifting sequence. See timeslot number series (TNS) definition in table below.

**Table 1 (subclause 6.3.3):  $TNS_{i,j}$  definition**

TNSCN	$TNS_{TNSCN,0}$	$TNS_{TNSCN,1}$	TNSCN	$TNS_{TNSCN,0}$	$TNS_{TNSCN,1}$
0	(0, 1, 2, 4, 7, 5, 6, 3)	(0, 3, 5, 7, 6, 2, 1, 4)	16	(0, 1, 5, 6, 7, 4, 3, 2)	(0, 4, 7, 6, 2, 5, 1, 3)
1	(0, 1, 2, 5, 3, 6, 7, 4)	(0, 4, 1, 5, 7, 6, 3, 2)	17	(0, 2, 1, 3, 6, 7, 5, 4)	(0, 3, 7, 4, 1, 5, 6, 2)
2	(0, 1, 2, 6, 5, 3, 7, 4)	(0, 3, 6, 7, 5, 2, 4, 1)	18	(0, 2, 1, 5, 6, 7, 4, 3)	(0, 4, 7, 5, 1, 3, 6, 2)
3	(0, 1, 2, 6, 7, 5, 4, 3)	(0, 3, 7, 4, 6, 2, 5, 1)	19	(0, 2, 3, 4, 7, 6, 5, 1)	(0, 3, 1, 5, 2, 6, 7, 4)
4	(0, 1, 3, 2, 5, 6, 7, 4)	(0, 4, 7, 6, 2, 1, 5, 3)	20	(0, 2, 3, 6, 7, 5, 1, 4)	(0, 4, 7, 6, 3, 5, 2, 1)
5	(0, 1, 3, 6, 7, 5, 2, 4)	(0, 3, 7, 4, 2, 6, 5, 1)	21	(0, 2, 3, 7, 5, 6, 4, 1)	(0, 3, 6, 2, 1, 5, 7, 4)
6	(0, 1, 4, 2, 5, 6, 7, 3)	(0, 2, 6, 3, 7, 5, 4, 1)	22	(0, 2, 4, 7, 3, 6, 5, 1)	(0, 3, 5, 6, 7, 4, 1, 2)
7	(0, 1, 4, 2, 5, 7, 6, 3)	(0, 4, 7, 3, 5, 6, 2, 1)	23	(0, 2, 5, 3, 6, 7, 4, 1)	(0, 3, 7, 6, 5, 1, 2, 4)
8	(0, 1, 4, 2, 6, 5, 7, 3)	(0, 2, 1, 5, 3, 6, 7, 4)	24	(0, 2, 5, 3, 7, 6, 4, 1)	(0, 3, 5, 1, 2, 6, 7, 4)
9	(0, 1, 4, 5, 7, 3, 6, 2)	(0, 3, 7, 6, 5, 2, 4, 1)	25	(0, 2, 6, 3, 1, 5, 7, 4)	(0, 3, 4, 7, 6, 5, 1, 2)
10	(0, 1, 4, 6, 5, 7, 3, 2)	(0, 4, 7, 5, 1, 2, 6, 3)	26	(0, 2, 6, 5, 1, 4, 7, 3)	(0, 4, 5, 7, 6, 3, 1, 2)
11	(0, 1, 4, 7, 3, 5, 6, 2)	(0, 4, 2, 1, 5, 7, 6, 3)	27	(0, 2, 6, 5, 3, 7, 4, 1)	(0, 3, 6, 7, 5, 1, 2, 4)
12	(0, 1, 4, 7, 6, 3, 5, 2)	(0, 4, 2, 1, 5, 6, 7, 3)	28	(0, 3, 5, 1, 2, 6, 7, 4)	(0, 4, 7, 6, 5, 2, 3, 1)
13	(0, 1, 5, 2, 4, 7, 6, 3)	(0, 3, 7, 5, 1, 4, 6, 2)	29	(0, 3, 5, 2, 6, 7, 4, 1)	(0, 4, 7, 3, 6, 5, 1, 2)
14	(0, 1, 5, 2, 6, 4, 7, 3)	(0, 3, 4, 5, 7, 6, 2, 1)	30	(0, 3, 6, 7, 4, 2, 5, 1)	(0, 4, 1, 2, 6, 5, 7, 3)
15	(0, 1, 5, 6, 2, 4, 7, 3)	(0, 3, 7, 6, 4, 5, 2, 1)	31	(0, 3, 7, 5, 6, 2, 4, 1)	(0, 4, 7, 6, 3, 5, 1, 2)

Parameters sent on a dedicated connection during the CTS-MS attachment:

- a) TNSCO : TNS couple order (1 bit), defines together with TNSCN the ordered couple (TNS1, TNS2).

if TNSCO = 0 then (TNS1, TNS2) = ( $TNS_{TNSCN,0}$ ,  $TNS_{TNSCN,1}$ )

if TNSCO = 1 then (TNS1, TNS2) = ( $TNS_{TNSCN,1}$ ,  $TNS_{TNSCN,0}$ )

- b) parameters to be used to form the timeslot shifting sequence.

x0 : 0 to 7, 3 bits

x1 : 0 to 7, 3 bits

x2 : 0 to 7, 3 bits

x3 : 0 to 7, 3 bits

For a given set of parameters, a unique timeslot shifting sequence of length of  $8 \times 51$  52-multiframes is defined. The shifting sequence is repeated 128 times over the duration of a GSM hyperframe. It is divided into 8 sets of 51 52-multiframes. The structure of a set is explicitly shown on figure below :

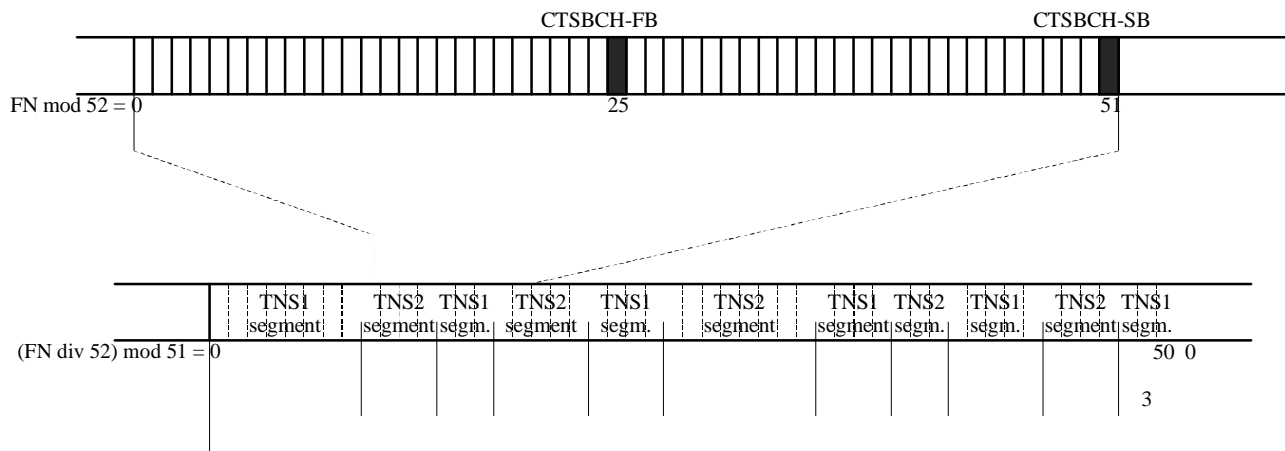

**Figure 1 (subclause 6.3.3): Structure of timeslot shifting sequence**

A set is formed by interleaving segments of TNS1 and TNS2. The mapping of TNS1 and TNS2 segments onto a set is defined by the parameters  $x_0, x_1, x_2, x_3$  as follows :

- for  $(FN \text{ div } 52) \bmod 51 = 0$  to 7 a TNS1 segment is used
- for  $(FN \text{ div } 52) \bmod 51 = 8$  to  $7+x_3$  a TNS2 segment is used
- for  $(FN \text{ div } 52) \bmod 51 = 8+x_3$  to  $7+x_3+x_2$  a TNS1 segment is used
- for  $(FN \text{ div } 52) \bmod 51 = 8+x_3+x_2$  to  $7+x_3+x_2+x_1$  a TNS2 segment is used
- for  $(FN \text{ div } 52) \bmod 51 = 8+x_3+x_2+x_1$  to  $7+x_3+x_2+x_1+x_0$  a TNS1 segment is used
- for  $(FN \text{ div } 52) \bmod 51 = 8+x_3+x_2+x_1+x_0$  to  $15+x_3+x_2+x_1+x_0$  a TNS2 segment is used
- for  $(FN \text{ div } 52) \bmod 51 = 16+x_3+x_2+x_1+x_0$  to  $23+x_3+x_2+x_1$  a TNS1 segment is used
- for  $(FN \text{ div } 52) \bmod 51 = 24+x_3+x_2+x_1$  to  $31+x_3+x_2$  a TNS2 segment is used
- for  $(FN \text{ div } 52) \bmod 51 = 32+x_3+x_2$  to  $39+x_3$  a TNS1 segment is used
- for  $(FN \text{ div } 52) \bmod 51 = 40+x_3$  to 47 a TNS2 segment is used
- for  $(FN \text{ div } 52) \bmod 51 = 48$  to 50 a TNS1 segment is used

The TNS1 and TNS2 segments are extracted from TNS1 and TNS2 according to the following rules :

- a) The first CTSBCH TN used in a shifting sequence shall be the TNS1.
- b) Two consecutive CTSBCH TN shall be separated by single circular shifts along TNS1 and TNS2.
- c) When changing from a TNS $_i$  segment to a TNS $_j$  segment, the last timeslot obtained from TNS $_i$  shall be followed by its immediate successor in TNS $_j$ .

NOTE: The first timeslot of a set is obtained by three circular shifts in TNS1 with regard to the first timeslot of the previous set.

An example of the mapping of TNS1 and TNS2 onto the first set of the generated shifting sequence is given in annex C.

### 6.3.3.2 CTSPCH, CTSARCH and CTSAGCH timeslot assignment

For the CTSPCH, CTSARCH and CTSAGCH, the timeslot shall be assigned by the CTS-FP for each 52-multiframe. The timeslot number used for CTSPCH, CTSARCH and CTSAGCH shall be the TNC broadcast in the previous 52-multiframe CTSBCH-SB.



## 6.3.4 Mapping in time of Extended Coverage control channels onto physical channels

### 6.3.4.1 General

The mapping in time of Extended Coverage control channels is defined in table 6a of clause 7, and is illustrated in figure 11 to figure 17. The table and figures also define the relationship of the air interface TDMA frames to the multiframe.

In addition to the information in table 6a and figures 11 to 18, further information is provided for EC-CCCH in subclause 6.3.4.2 and 6.3.4.3, and for the mapping of the EC-BCCH data in subclause 6.3.4.4.

### 6.3.4.2 Mapping of the downlink Extended Coverage CCCH (EC-CCCH/D)

The EC-CCCH and its different logical channels (EC-AGCH, EC-PCH) can be mapped dynamically and are identified by the message header. The mapping is as defined in table 6a of clause 7 and is illustrated in figure 13, figure 14 and figure 15. The EC-CCCH blocks constitute different number of blind physical layer transmissions depending on the downlink Coverage Class used, see table 6a, and illustration in figure 13, figure 14 and figure 15. One, eight, sixteen or thirty-two corresponding CC1 blocks are used for CC1, CC2, CC3 and CC4 EC-CCCH blocks respectively. In case of CC2 and CC3, the bursts are mapped over two 51-multiframes, and for CC4 over four 51-multiframes. For CC1 each block is contained in a single 51-multiframe.

### 6.3.4.3 Mapping of the uplink Extended Coverage CCCH (EC-CCCH/U)

The mapping of the EC-RACH (EC-CCCH/U) is defined in table 6a of clause 7 and illustrated in figure 16 and figure 17, where the possible blocks are indicated for each uplink Coverage Class (CC1 to CC5). Furthermore, two different EC-RACH mappings exist. The mapping to be used is signalled on cell level in EC SI, see 3GPP TS 44.018. The EC-RACH is either mapped onto a single TS, or over 2 consecutive TS for CC2, CC3, CC4 and CC5. CC1 EC-RACH is always mapped onto 1 TS.

The EC-RACH is fixed allocated in the full 51-multiframe. The EC-RACH blocks constitute different number of EC-RACH bursts depending on the uplink Coverage Class used, see table 6a and illustration in figure 16 and figure 17. One, four, sixteen, forty-eight bursts are used for CC1, CC2, CC3 and CC4 EC-RACH blocks respectively. For ESAB sixty-six ESABs are used for the CC5 EC-RACH block, for EDAB sixty-six EDABs are used for the CC5 EC-RACH block. In case of CC5 the bursts are mapped over three 51-multiframes, for CC4 the bursts are mapped over two 51-multiframes, and for Coverage Classes CC1 to CC3 each block is contained in a single 51-multiframe.

### 6.3.4.4 Mapping of EC-BCCH data

In order to facilitate the MS operation, the network is required to transmit EC System Information (EC SI) messages on EC-BCCH blocks, each EC-BCCH block mapped onto 8 consecutive TDMA frames in each of 8 consecutive 51-multiframes, see table 6a and figure 12. An EC SI message may consist of one or more message instances (see 3GPP TS 44.018) where each EC SI message instance is transmitted in one EC-BCCH block (one EC-BCCH block consisting of 16 blind physical layer transmissions of an EC SI message instance as described in 3GPP TS 45.003).

The following rules apply:

- i) An EC SI message instance is started in the 51-multiframe when  $TC = (FN \text{ DIV } 51) \bmod 8 = 0$ ,
- ii) The EC SI messages (see 3GPP TS 44.018) shall be sent in sequence in ascending order according to the EC SI message type (EC SI 1, EC SI 2, EC SI 3 and EC SI 4) without repeating any given EC SI message or EC SI message instance (except for blind physical layer transmissions within an EC-BCCH block) before all instances of all EC SI messages have been sent.
- iii) When there are multiple EC SI message instances of an EC SI message each EC SI message instance shall be sent in ascending order according to the value of the EC SI N\_INDEX (N=1 to 4) included in each message instance (see 3GPP TS 44.018)
- iv) A full set of EC SI messages includes a single transmission of each EC SI message/message instance sent according to ii) and iii).

An example is provided below where it is assumed that EC SI message 1, 2, 3 and 4 are sent by the network, and where EC SI 3 contains two EC SI message instances. In this case, the full set of EC SI messages would be transmitted using the following sequence:

EC SI 1; EC SI 2; EC SI 3(EC SI 3\_INDEX=0) ; EC SI3(EC SI 3\_INDEX=1); EC SI 4

## 6.4 Permitted channel combinations

### 6.4.1 Permitted channel combinations onto a basic physical channel

The following are the permitted ways, as defined by 3GPP TS 44.003, in which channels can be combined onto basic physical channels for one or several MSs.

The following definitions are used in the list of combinations below.

<u>Combination designation</u>	<u>Channel combination</u>
SUB_TA	TCH/H + FACCH/H + SACCH/TH
SUB_T	TCH/H
SUB_PA	PDTCH/H + PACCH/H
SUB_TE	TCH/H + FACCH/H + SACCH/TPH + EPCCH/H
SUB_OTA	O-TCH/H + O-FACCH/H + SACCH/TH
SUB_OT	O-TCH/H
SUB_OTE	O-TCH/H + O-FACCH/H + SACCH/TPH + EPCCH/H

Numbers appearing in parenthesis after channel designations indicate sub-channel numbers. (0..n) shall be interpreted as subchannel 0, 1, ..., n-1 and n. Channels and sub-channels need not necessarily be assigned.

- i) TCH/F + FACCH/F + SACCH/TF
- ii) O-TCH/F + O-FACCH/F + SACCH/TF
- iii)
- iv) FCCH + SCH + BCCH + CCCH
- v) FCCH + SCH + BCCH + CCCH + SDCCH/4(0..3) + SACCH/C4(0..3)
- vi) BCCH + CCCH
- vii) SDCCH/8(0..7) + SACCH/C8(0..7)
- viii) TCH/F + FACCH/F + SACCH/M
- ix) TCH/F + SACCH/M
- x) TCH/FD + SACCH/MD
- xi) PBCCH + PCCCH + PDTCH/F + PACCH/F + PTCCH/F
- xii) PCCCH + PDTCH/F + PACCH/F + PTCCH/F
- xiii) PDTCH/F + PACCH/F + PTCCH/F
- xiv) CTSBCH + CTSPCH + CTSARCH + CTSAGCH

- xv) CTSPCH + CTSARCH + CTSAGCH
- xvi) CTSBCH
- xvii) CTSBCH + TCH/F + FACCH/F + SACCH/CTS
- xviii) E-TCH/F + E-IACCH/F + E-FACCH/F + SACCH/TF
- xix) E-TCH/F + E-IACCH/F + E-FACCH/F + SACCH/M
- xx) E-TCH/F + E-IACCH/F + SACCH/M
- xxi) E-TCH/FD + E-IACCH/F + SACCH/MD
- xxii) CFCCH + CSCH + CPBCCH + CPCCCH + PDTCH/F + PACCH/F + PTCCH/F
- xxiii) CPCCCH + PDTCH/F + PACCH/F + PTCCH/F
- xiv) O-TCH/F + O-FACCH/F + SACCH/TPF + EPCCH/F
- xxv) TCH/F + FACCH/F + SACCH/TPF + EPCCH/F
- xxvi) TCH/F + FACCH/F + SACCH/MP + EPCCH/M
- xxvii) TCH/F + SACCH/MP + EPCCH/M
- xxviii) TCH/FD + SACCH/MPD + EPCCH/MD
- xxix) PDTCH/F + PACCH/F + SACCH/TF
- xxx) PDTCH/F + PACCH/F + SACCH/TPF + EPCCH/F
- xxxii) PDTCH/F + PACCH/F + SACCH/M
- xxxiii) PDTCH/FD + PACCH/FD + SACCH/MD
- xxxiv) PDTCH + PACCH/F + SACCH/M + EPCCH/M
- xxxv) PRACH + PDTCH/U + PACCH/U + PTCCH/U + MPRACH
- xxxvi) PDTCH/U + PACCH/U + PTCCH/U + MPRACH
- xxxvii) EC-SCH + EC-BCCH + EC-CCCH
- xxxviii) FCCH + SCH + BCCH + CCCH + EC-CCCH/U
- xxxix) EC-CCCH
- xl) BCCH + CCCH + EC-CCCH/U
- xli) EC-PDTCH/F + EC-PACCH/F
- xlii) EC-PDTCH/F + EC-PACCH/F + PDTCH/F + PACCH/F + PTCCH/F

The following combinations of half rate channels are allowed on a basic physical channel for a single mobile, where the second half rate channel need not be assigned:

- a1) SUB\_TA + SUB\_T (Lm + Lm configuration)
- a2) SUB\_TA + SUB\_OT (Lm + Lm configuration)
- a3) SUB\_TA + SUB\_PA (DTM single slot)
- a4) SUB\_TE + SUB\_T (Lm + Lm configuration)
- a5) SUB\_TE + SUB\_OT (Lm + Lm configuration)

- a6) SUB\_TE + SUB\_PA (DTM single slot)
- a7) SUB\_OTA + SUB\_OT (Lm + Lm configuration)
- a8) SUB\_OTA + SUB\_T (Lm + Lm configuration)
- a9) SUB\_OTA + SUB\_PA (DTM single slot)
- a10) SUB\_OTE + SUB\_OT (Lm + Lm configuration)
- a11) SUB\_OTE + SUB\_T (Lm + Lm configuration)
- a12) SUB\_OTE + SUB\_PA (DTM single slot)

The following combinations of half rate channels are allowed on a basic physical channel for two mobiles:

- b1) SUB\_TA + SUB\_TA
- b2) SUB\_TA + SUB\_TE
- b3) SUB\_TA + SUB\_OTA
- b4) SUB\_TA + SUB\_OTE
- b5) SUB\_TE + SUB\_TE
- b6) SUB\_TE + SUB\_OTA
- b7) SUB\_TE + SUB\_OTE
- b8) SUB\_OTA + SUB\_OTA
- b9) SUB\_OTA + SUB\_OTE
- b10) SUB\_OTE + SUB\_OTE

The following combinations of full rate channels are allowed on a basic physical channel capable of VAMOS for two mobiles in *VAMOS mode* (where the 2 full rate channels constitute a *VAMOS pair*):

- c11) i) + i)
- c12) i) + xxv)
- c13) xxv) + xxv)

The following combinations of full rate and half rate channels are allowed on a basic physical channel capable of VAMOS for three mobiles in *VAMOS mode* (where the half rate channel on sub-channel number 0 and the full rate channel constitute one *VAMOS pair* whilst the half rate channel on sub-channel number 1 and the full rate channel constitute a different *VAMOS pair* on the same basic physical channel capable of VAMOS)

- d1) SUB\_TA + SUB\_TA + i)
- d2) SUB\_TA + SUB\_TA + xxv)
- d3) SUB\_TA + SUB\_TE + i)
- d4) SUB\_TA + SUB\_TE + xxv)
- d5) SUB\_TE + SUB\_TE + i)
- d6) SUB\_TE + SUB\_TE + xxv)

The following combinations of half rate channels are allowed on a basic physical channel capable of VAMOS for 3 mobiles of which 2 are in *VAMOS mode* (where the pair of half rate channels sharing the same sub-channel number constitutes the *VAMOS pair* whilst the other half rate channel is not in *VAMOS mode*)

- e1) SUB\_TA + SUB\_TA + SUB\_TA

- e2) SUB\_TA + SUB\_TA + SUB\_TE
- e3) SUB\_TE + SUB\_TE + SUB\_TA
- e4) SUB\_TE + SUB\_TE + SUB\_TE

The following combinations of half rate channels are allowed on a basic physical channel capable of VAMOS for four mobiles in *VAMOS mode* (where the pair of half rate channels on the sub-channel number 0 constitutes one *VAMOS pair* and the other pair of half rate channels on the sub-channel number 1 constitutes the other *VAMOS pair*):

- f1) SUB\_TA + SUB\_TA + SUB\_TA + SUB\_TA
- f2) SUB\_TA + SUB\_TA + SUB\_TA + SUB\_TE
- f3) SUB\_TA + SUB\_TA + SUB\_TE + SUB\_TE
- f4) SUB\_TA + SUB\_TE + SUB\_TE + SUB\_TE
- f5) SUB\_TE + SUB\_TE + SUB\_TE + SUB\_TE

NOTE 0: CCCH = PCH+ RACH + AGCH + NCH.

EC-CCCH = EC-PCH+EC-RACH+EC-AGCH.

PCCCH = PPCH+PRACH+PAGCH

CPCCCH = CPPCH + CPRACH + CPAGCH

EC-CCCH/U = EC-RACH

NOTE 1: Where the SMSCB is supported, the CBCH replaces SDCCH number 2 in cases v) and vii) above.

NOTE 2: A combined CCCH/SDCCH allocation (case v) above) may only be used when no other CCCH channel is allocated.

NOTE 3: Combinations viii), ix), x), xix), xx), xxi), xxix), xxx), xxxi) and xxxii) are used without EPC in multislot configurations as defined in subclause 6.4.2.

NOTE 4: Combinations xiv), xv), xvi) and xvii) shall be used in CTS; combinations xiv), xvi) and xvii) shall be mutually exclusive; combinations xiv) and xv) shall also be mutually exclusive.

NOTE 5: Combinations xxii) and xxiii) shall be used for COMPACT on serving time groups.

NOTE 6: Combinations i), ii), xiii), xxv), xxiv) or any of a1) to a12) shall be used for single timeslot operation in DTM.

NOTE 7: A unidirectional TCH combination i), viii), ix) or x) may be combined with the corresponding E-TCH combination xviii), xix), xx) or xxi) respectively in the other direction.

NOTE 8: Combinations xxvi), xxvii), xxviii), xxxii), xxxiii) and xxxiv) are used with EPC in multislot configurations as defined in subclause 6.4.2.

NOTE 9: The basic physical channel onto which channels can be combined according to combinations i), ii), viii), ix), x), xviii), xix), xx), xxi), xxiv), xxv), xxvi), xxvii), xxviii), xxix), xxx), xxxi), xxxii), xxxiii) and xxxiv) is referred to as dedicated basic physical subchannel full rate (DBPSCH/F) in *Iu mode*.

NOTE 10: The basic physical channel onto which channels can be combined according to combinations xi), xii) and xiii) is referred to as shared basic physical subchannel full rate (SBPSCH/F) in *Iu mode*.

NOTE 11: The part of the basic physical channel onto which channels can be combined according to combinations SUB\_TA, SUB\_T, SUB\_PA, SUB\_TE, SUB\_OT, SUB\_OT, SUB\_OTE is referred to as dedicated basic physical subchannel half rate (DBPSCH/H) in *Iu mode*.

NOTE 12: The part of the basic physical channel onto which channels can be combined according to combination SUB\_PA is referred to as shared basic physical subchannel half rate (SBPSCH/H) in *Iu mode*.

NOTE 13: The parts of the basic physical channel onto which SDCCH and SACCH can be combined according to combination v) are referred to as dedicated basic physical subchannels for SDCCH/4 and SACCH/C4 (DBPSCH/S4) in *Iu mode*.

NOTE 14: The parts of the basic physical channel onto which SDCCH and SACCH can be combined according to combination vii) are referred to as dedicated basic physical subchannels for SDCCH/8 and SACCH/C8 (DBPSCH/S8) in *Iu mode*.

NOTE 15: Combinations xxxv) and xxxvi) are used only for MBMS.

NOTE 16: In RTTI configuration only combination xiii) shall be used.

NOTE 17: Combinations xxxviii) and xl) are only applicable if 2 TS EC-RACH mapping is used, and in that case to the lower numbered timeslot.

NOTE 18: Combinations xli) and xlii) with EC-PDTCH/F apply also to EC-PDTCH/2TS/F using 2 PDCHs for blind physical layer transmissions.

## 6.4.2 Multislot configurations

### 6.4.2.1 General

A multislot configuration consists of multiple circuit or packet switched traffic channels together with associated control channels, assigned to the same MS or, in the case of point-to-multipoint transmission, a group of MSs. As an exception if blind physical layer transmissions are used in EC operation, a multislot configuration consists of a single EC-PDTCH and/or EC-PACCH (the associated control channel) mapped onto multiple physical channels.

The multislot configuration occupies up to 8 basic physical channels, with different timeslots numbers (TN) but with the same frequency parameters (ARFCN or MA, MAIO and HSN) and the training sequence with the same training sequence code (TSC) which may be selected from different TSC Sets in case of multislot configurations for dual transfer mode in *A/Gb mode* (see subclause 6.4.2.3). For a mobile station supporting the extended TSC set, up to two training sequences may be used on the same timeslot number with the same frequency parameters for packet switched traffic channels. In this case the training sequences are chosen from different TSC sets.

#### 6.4.2.1 Multislot configurations for circuit switched connections in *A/Gb mode*

In *A/Gb mode*, two types of multislot configurations exist, symmetric and asymmetric. The symmetric case consists of only bi-directional channels. The asymmetric case consists of both bi-directional and unidirectional downlink channels.

The occupied physical channels shall consist of the following channel combinations as defined in subclause 6.4.1.

one main channel of type viii) or xix) +  
 x secondary channels of type ix) or xx) +  
 y secondary channels of type x) or xxi)

When in EPC mode (see 3GPP TS 45.008) the occupied physical channels shall consist of the following channel combinations as defined in subclause 6.4.1.

one main channel of type xxvi) +  
 x secondary channels of type xxvii) +  
 y secondary channels of type xxviii)

where  $0 \leq x \leq 7, y = 0$  for symmetric multislot configuration

$0 \leq x \leq 6, 1 \leq y \leq 7, x+y \leq 7$  for asymmetric multislot configuration

The main channel is the bi-directional channel that carries the main signalling (FACCH and SACCH) for the multislot configuration. The position of the main channel is indicated by the assignment message (3GPP TS 44.018). Secondary channels may be added or removed without changing the main channel.

The assignment of channels to a Multislot Configuration must always consider the multislot capability of the MS, as defined by the multislot class described in annex B.

There is no limitation in this TS to the possible TCH types (see subclause 3.2) which may be used in a Multislot Configuration.

High Speed Circuit Switched Data (HSCSD) is one case of multislot configuration. The full rate traffic channels of a HSCSD configuration shall convey the same user bit rate (see subclause 3.2.3).

NOTE: For the maximum number of timeslots to be used for a HSCSD, see 3GPP TS 23.034.

#### 6.4.2.2 Multislot configurations for packet switched connections in *A/Gb mode*

In *A/Gb mode*, an MS may be assigned several (EC-)PDTCH/Us or (EC-)PDTCH/Ds for one mobile originated or one mobile terminated communication respectively, mapped onto a corresponding number of PDCHs in BTTI configuration or a corresponding number of PDCH-pairs in RTTI configuration. An exception applies for EC operation when CC2, CC3 or CC4 has been assigned in which case only one EC-PDTCH/U or one EC-PDTCH/D is mapped onto four consecutive PDCHs in BTTI configuration.

The total number of assigned uplink PDCHs and downlink PDTCHs shall not exceed the total number of uplink and downlink timeslots that can be used by the MS per TDMA frame (i.e., the parameter 'Sum' specified in Annex B). An exception is the case of EC operation where uplink and downlink PDCHs are not allocated simultaneously in the same TDMA frame (for details see Annex B.1) and hence the number of assigned uplink and downlink PDCHs shall not exceed the maximum number of receiving and transmitting timeslots respectively, that can be used by the MS per TDMA frame (i.e. the parameters 'Rx' and 'Tx' respectively in Annex B). In this context "assignment" refers to the list of PDCH given in the assignment message and that may dynamically, or in the case of EC operation in the UL, by Fixed Uplink Allocation, carry the (EC-)PDTCHs for that specific MS.

Alternatively, for a multislot class type 1 MS supporting Flexible Timeslot Assignment (see 3GPP TS 24.008) the network may assign a total number of uplink and downlink PDCHs exceeding the parameter 'Sum' specified in Annex B, provided that the number of assigned downlink PDCHs shall not exceed the number of downlink timeslots that can be used by the MS per TDMA frame (i.e., the parameter 'Rx' specified in Annex B) and the number of assigned uplink PDCHs shall not exceed the number of uplink timeslots that can be used by the MS per TDMA frame (i.e., the parameter 'Tx' specified in Annex B). In this case, the network shall ensure that, in each radio block period, the total number of uplink and downlink PDCHs that have been allocated to the MS does not exceed the total number of uplink and downlink timeslots that can be used by the MS per TDMA frame (i.e., the parameter 'Sum' specified in Annex B).

Alternatively, when Enhanced Flexible Timeslot Assignment, EFTA, is used (see 3GPP TS 24.008) the network shall follow the same procedure as for Flexible Timeslot Assignment as described above with the exception that, during any given radio block period, the total number of uplink and downlink PDCHs that have been allocated to the MS may exceed the total number of uplink and downlink timeslots defined by the parameter 'Sum' specified in Annex B.

NOTE 1: In the downlink, a PDCH is 'allocated' to an MS in a radio block period if the network transmits an RLC/MAC block for the MS on that PDCH during that radio block period.

In RTTI configuration, PDCHs shall be assigned in pairs.

If there are  $m$  timeslots assigned for reception and  $n$  timeslots assigned for transmission:

- For a multislot class type 1 MS, there shall be  $\text{Min}(m,n,2)$  reception and transmission timeslots with the same TN;
- For a multislot class type 2 MS, there shall be  $\text{Min}(m,n)$  reception and transmission timeslots with the same TN.

In the case of downlink dual carrier or DLMC configurations, if timeslots with the same timeslot number are assigned on more than one carrier, in calculating the value of  $m$  they shall be counted as one timeslot.

The mapping of (EC-)PACCH onto the assigned downlink PDCHs or the allocated uplink PDCHs is specified in 3GPP TS 44.060.

For multislot class type 1 MS, Table 6.4.2.2.1 lists the number of timeslots (in a dual carrier configuration or a DLMC configuration the number of timeslots apply on a per radio frequency basis) that are possible to assign (provided that it is supported by the MS according to its multislot class) for different medium access modes (see 3GPP TS 44.060). It also indicates if the network (or the MS in case of EFTA) shall apply  $T_{ra}$  or  $T_{ta}$  (see annex B), and if Shifted USF operation shall apply (see 3GPP TS 44.060). Additionally, it indicates which configurations can also be used for allocation

(provided that they are compatible with the number of timeslots assigned to the MS). For a MS in EC operation Table 6.4.2.2.1 does not apply since all assignments according to its multislot class are possible.  $T_{ra}$  and  $T_{ta}$  (see Annex B) do not apply in EC operation.

NOTE 2: In case of extended dynamic allocation, the MS needs to support USF monitoring on the downlink PDCHs corresponding to (i.e. with the same timeslot number as) all assigned uplink PDCHs as defined in 3GPP TS 44.060.

In a dual carrier or a DLMC configuration, all the downlink timeslots on all radio frequency channels shall be assigned within a window of size 'd' and all the uplink timeslots on all radio frequency channels shall be assigned within a window of size 'u' where 'd' and 'u' are defined in Table 6.4.2.2.1.

In a dual carrier configuration the maximum number of timeslots that may be assigned (uplink and downlink) depends on the multislot class of the MS (or the Equivalent multislot class if different from the Signalled multislot class as described in B.4) and the multislot capability reduction for downlink dual carrier.

In a DLMC configuration the maximum number of timeslots that may be assigned (uplink and downlink) depends on the multislot class of the MS and the supported Maximum Number of Downlink Timeslots, see 3GPP TS 24.008.

The maximum number of radio frequency channels on which downlink timeslots may be assigned in a DLMC configuration is dependent on the supported Maximum Number of Downlink Carriers, see 3GPP TS 24.008.

In a dual carrier or a DLMC configuration, Shifted USF operation shall be determined per carrier according to the number of downlink and uplink timeslots assigned on each carrier



Table 6.4.2.2.1: Multislot configurations for packet switched connections in A/Gb mode

Medium access mode	No of Slots (Note 0)	$T_{ra}$ shall apply	$T_{ra}$ shall apply	Applicable Multislot classes (see Note 7)	Note
Downlink, any mode	d = 1-6	Yes	-	1-12, 19-45	
	d = 7-8	No	-	24-29	1,2
Uplink, Dynamic	u = 1-2	Yes	-	1-12, 19-45	10
	u = 2	-	Yes	12, 36-39	11
	u = 3	-	Yes	12, 37-39	9
	u = 2-3	Yes	-	31-34, 41-45	9
Uplink, Ext. Dynamic	u = 1-3	Yes	-	1-12, 19-45	
	u = 4	-	Yes	12, 22-23, 27-29	2
	u = 4	Yes	-	33-34, 38-39, 43-45	2
	u = 5	Yes	-	34, 39	2,3,5
	u = 5	-	Yes	44-45	2,4
	u = 4	Yes	-	30-39	12
	u = 4	-	Yes	40-45	12
	u = 5	Yes	-	30-39	5, 12
	u = 5	-	Yes	40-45	5, 12
	u = 6	-	Yes	45	2,4,5
Down + up, Dynamic	d+u = 2-5, u < 3	Yes	-	1-12, 19-45	10
	d+u = 6, u < 3	Yes	-	30-45	2,3
	d+u = 7, u < 3	-	Yes	40-45	2,4
	d = 2, u = 3	Yes	-	32-34, 42-45	9
	d+u = 5, u = 2 – 3	-	Yes	12,36-39	9
	d+u = 6, u = 3-4	Yes	-	32-34,37-39,42-45	2,3,9
	d+u = 7, u = 3-4	-	Yes	42-45	2,4,9
	d = 4, u = 4	Yes	-	33-34,38-39,43-45	2,3,8,9
	d = 4, u = 5	-	Yes	44-45	2,4,8,9
	d+u = 8-10, u < 3	Yes	-	30-45	12
Down + up, Ext. Dynamic	d+u = 2-4	Yes	-	1-12, 19-45	
	d+u = 5, d > 1	Yes	-	8-12, 19-45	
	d+u = 6-7, u < 4	Yes	-	10-12	8
	d = 1, u = 4	-	Yes	12, 22-23, 27-29	2
	d > 1, u = 4	-	Yes	12	2,8
	d = 1, u = 4	Yes	-	33-34, 38-39, 43-45	2,6
	d+u = 6, d > 1	Yes	-	30-45	2,3
	d = 1, u = 5	Yes	-	34,39	2,3,5
	d+u = 7-9, u < 5	Yes	-	31-34, 36-39	2,3,8
	d=2-5, u = 5	Yes	-	34,39	2,3,5,8
	d = 1, u = 5	-	Yes	44-45	2,4
	d+u = 7, d > 1	-	Yes	40-45	2,4
	d = 1, u = 6	-	Yes	45	2,4,5
	d+u = 8-11, u < 6	-	Yes	41-45	2,4,8
	d=2-6, u = 6	-	Yes	45	2,4,5,8
	d=6-8, u=1-4	Yes	-	30-39	12
	d=6-8, u=5	Yes	-	34,39	5,12
	d=7-8, u=1-4	-	Yes	40-45	12
	d=7-8, u=5-6	-	Yes	44-45	5,12

Note 0	If the downlink timeslots assigned (allocated) to the mobile station are not contiguous, d shall also include the number of downlink timeslots not assigned (allocated) to the mobile station that are located between assigned (allocated) downlink timeslots. Similarly, if the uplink timeslots assigned (allocated) to the mobile station are not contiguous, u shall also include the number of uplink timeslots not assigned (allocated) to the mobile station that are located between assigned (allocated) uplink timeslots.
Note 1	Normal measurements are not possible (see 3GPP TS 45.008).
Note 2	Normal BSIC decoding is not possible (see 3GPP TS 45.008) except e.g. in case of a downlink dual carrier capable MS operating in single carrier mode using its second receiver for BSIC decoding.
Note 3	TA offset required for multislot classes 35-39.
Note 4	TA offset required for multislot classes 40-45.
Note 5	Shifted USF operation shall apply (see 3GPP TS 44.060).
Note 6	The network may fallback to a lower multislot class and may not apply $T_{ra}$ . A multislot class 38 or 39 MS shall in this case use $T_{ra}$ for timing advance values below 31.
Note 7	For dual carrier operation the Applicable Multislot class is the Signalled multislot class or the Equivalent multislot class (if different from the Signalled multislot class) as defined in Table B.2. For EFTA operation the Applicable Multislot class is the Signalled multislot class.
Note 8	These configurations can only be used for assignment to an MS supporting Flexible Timeslot Assignment (see 3GPP TS 24.008). For allocation additional restrictions apply.
Note 9	These configurations can be used only in RTTI configuration.
Note 10	These configurations can be used in RTTI configurations only when the timeslots of the corresponding downlink PDCH-pair are contiguous.
Note 11	These configurations can be used only in RTTI configurations when the timeslots of the corresponding downlink PDCH-pair are not contiguous.
Note 12	These configurations can only be used for assignment to an MS for which Enhanced Flexible Timeslot Assignment with extended receive capability is used (see Annex B.5 and 3GPP TS 44.060). Whether normal measurements (see 3GPP TS 45.008) and/or normal BSIC decoding (see 3GPP TS 45.008) are possible will be dependent on the allocation or on the use of a second receiver for this purpose.

For multislot class type 2 MS, all assignments according to its multislot class are possible independent of the MAC mode.

For GPRS and EGPRS; the occupied physical channels shall consist of a combination of configurations xi, xii, xiii and xlii) as defined in subclause 6.4.1. For COMPACT, the occupied physical channels shall consist of a combination of configurations xiii), xxii), and xxiii), as defined in subclause 6.4.1. For EC-GSM-IoT, the occupied physical channels shall consist of a combination of configurations xli) or xlii).

The network shall leave a gap of at least one radio block period between the old and the new configuration, when the assignment is changed and PDCHs with the lowest numbered timeslot are not the same in the old and new configuration. For multislot class type 1 MS, the gap shall be left in both uplink and downlink when the lowest numbered timeslot for the combined uplink and downlink configuration is changed. For multislot class type 2 MS, the gap shall be left in the link (uplink and/or downlink) where the lowest numbered timeslot has been changed.

### 6.4.2.3 Multislot configurations for dual transfer mode in *A/Gb mode*

For DTM in *A/Gb mode*, a multislot configuration consists of a single traffic channel (TCH, O-TCH or E-TCH) and one or more packet data traffic channels (PDTCH) together with associated control channels assigned to the same mobile station. The mix of full and half rate packet data channels is not allowed in the uplink. This mix is only defined for the downlink direction and only supported by mobile stations indicating Extended GPRS DTM Multi Slot Class or Extended EGPRS DTM Multi Slot Class capability (see 3GPP TS 24.008). The PDTCH/H is only allowed on the time slot assigned for half rate circuit switched connection.

**NOTE:** In the case of extended dynamic allocation, the MS needs to support USF monitoring on the downlink PDCHs corresponding to (i.e. with the same timeslot number as) all assigned uplink PDCHs, as defined in 3GPP TS 44.060. This also restricts multislot configurations where USF monitoring is not possible for all assigned uplink PDCHs because of the presence of the dedicated channel. As an exception, if the mobile station indicates support of DTM high multislot class capability, the network may assign a multislot configuration where USF monitoring is not possible for all assigned uplink PDCHs because of the presence of the dedicated channel. In this case, the mobile station behaves as described in 3GPP TS 44.060.

A mobile station indicating support of Flexible Timeslot Assignment (see 3GPP TS 24.008) shall support Flexible Timeslot Assignment while in dual transfer mode. A mobile station indicating support of Enhanced Flexible Timeslot Assignment (see 3GPP TS 24.008) shall support Enhanced Flexible Timeslot Assignment while in dual transfer mode.

The network shall leave a gap of at least one radio block between the old and the new configuration, when the assignment is changed and PDCHs with the lowest numbered timeslot are not the same in the old and new configuration. For multislot class type 1 MS, the gap shall be left in both uplink and downlink when the lowest numbered timeslot for the combined uplink and downlink configuration is changed.

A mobile station indicating support for VAMOS I, VAMOS II or VAMOS III (see 3GPP TS 24.008) shall support VAMOS mode of operation while in dual transfer mode. In case of DTM in *A/Gb mode* the training sequence for the packet data traffic channels (PDTCH) together with associated control channels shall have the same training sequence code (TSC) as the TSC of the traffic channel together with the associated control channels and shall be selected from TSC Set 1. In case the mobile station indicates support for extended TSC sets, the TSC shall be selected from TSC set 1 or TSC set 2, except for GMSK modulation where the TSC is selected from TSC set 1 or TSC set 3.

#### 6.4.2.3a Multislot configurations for MBMS in *A/Gb mode*

In *A/Gb mode*, the network may assign several PDTCH/Ds for one broadcast/multicast session (see 3GPP TS 44.060). The total number of assigned PDTCH/Ds for one broadcast/multicast session shall not exceed 5 (4 if the MS must listen to the (P)BCCH and (P)CCCH in addition to the timeslots allocated for MBMS data transfer). In this context "assignment" refers to the list of PDCHs given in the assignment message and that may dynamically carry the PDTCHs. The PACCH/D may be mapped onto any of the assigned PDCHs.

An MBMS capable mobile station shall be capable of receiving one or more broadcast/multicast sessions on up to 5 contiguous timeslots within a TDMA frame (4 if the MS must listen to the (P)BCCH and (P)CCCH in addition to the timeslots assigned for MBMS data transfer). If the timeslots are not contiguous, the number of downlink timeslots not listened to by the mobile station that are located between downlink timeslots that are listened to shall also be included in this number.

NOTE 1: When receiving multiple broadcast/multicast sessions, the number of sessions that the mobile station can simultaneously receive depends on the radio resources assignment for the corresponding MBMS radio bearers.

As an exception in the case where the mobile station needs to listen to the (P)BCCH and (P)CCCH in addition to the timeslots assigned for MBMS data transfer, if PBCCH is present in the cell and BS\_PCC\_CHANS=1, the total number of PDTCH/Ds assigned for one broadcast/multicast session may equal 5 (including the PDTCH/D carried on the PDCH where PBCCH/PCCCH is mapped on). An MBMS capable mobile station shall then be capable of receiving one or more broadcast/multicast sessions on up to 5 contiguous timeslots within a TDMA frame, and in addition listen to the (P)BCCH and (P)CCCH, if the following conditions are met:

- the PDCH where PBCCH/PCCCH is mapped on is adjacent to the other PDCHs assigned for the MBMS radio bearer(s); and
- the same frequency parameters apply over the 5 PDCHs.

Additionally, up to one uplink timeslot per broadcast/multicast session may be assigned for PACCH/U. The timeslot allocated for transmission shall have the same TN as one of the timeslots used for reception. A multislot class type 1 MS receiving more than one broadcast/multicast session may transmit on up to two uplink timeslots, depending on the radio resources assigned for the MBMS radio bearers. The number ( $m$ ) of timeslots listened to by the mobile station for the reception of one or more broadcast/multicast sessions and the number ( $n$ ) of timeslots used by the mobile station for the transmission on PACCH/U within a TDMA frame shall be such that the sum of  $m$  and  $n$  does not exceed 6 (5 in case the mobile station needs to listen to the (P)BCCH and (P)CCCH in addition to the timeslots assigned for MBMS data transfer and the exception described in this sub-clause does not apply).

While in broadcast/multicast receive mode, an MBMS-capable MS shall be capable of receiving, in addition to the timeslots assigned for data transfer, on at least one further timeslot in order to read the BCCH and CCCH or the PBCCH and PCCCH (with the exception described in this sub-clause, where the timeslot carrying the PBCCH and PCCCH is one of the timeslots assigned for data transfer). This requirement does however not apply when the network transmits system information and paging messages on the PACCH of the MBMS radio bearer (see sub-clause 6.5.1, item xxii). The maximum number of timeslots that an MS is required to receive upon within a TDMA frame is 5, and the timeslots shall be assigned within a window of maximum size  $R_x=6$ . The number of PDTCH/Ds assigned and their TN shall be such that an MS receiving a given broadcast/multicast session shall be able to read the BCCH and CCCH or

the PBCCH and PCCCH without interrupting the reception of the broadcast/multicast session and the transmission on the uplink timeslot, if assigned, unless system information and paging messages are sent on the PACCH of the MBMS radio bearer. Depending on the number of CCCH or PCCCH allocated in the cell, the network may need to restrict the number of PDTCH/Ds assigned to one broadcast/multicast session.

For an MBMS capable mobile station, the minimum requirements shall be  $R_x=6$ ,  $T_x=2$ ,  $Sum=6$ ,  $T_{ia}=T_{tb}=T_{ra}=T_{rb}=1$ .

#### 6.4.2.4 Multislot configurations for DBPSCH in *lu mode*

##### 6.4.2.4.1 TCHs assigned

For a multislot class type 1 MS supporting MBMS, the values of  $T_{tb}$  and  $T_{ra}$  shall be equal to 1 (i.e. multislot classes 31-34, 41-45, see Annex B).

NOTE 2: Multislot classes 30 and 40 are not included since the corresponding mobile stations cannot transmit on up to two uplink timeslots.

##### 6.4.2.4.2 PDTCHs assigned

In *lu mode*, two types of multislot configurations exist, symmetric and asymmetric. The symmetric case consists of only bi-directional basic physical subchannels. The asymmetric case consists of both bi-directional and unidirectional downlink basic physical subchannels.

The occupied physical channels shall consist of the following channel combinations as defined in subclause 6.4.1.

x channels of type xxxi) +  
y channels of type xxxii)

When in EPC mode (see 3GPP TS 45.008) the occupied physical channels shall consist of the following channel combinations as defined in subclause 6.4.1.

x channels of type xxxiii) +  
y channels of type xxxiv)

where  $1 \leq x \leq 8$ ,  $y = 0$  for symmetric multislot configuration

$1 \leq x \leq 7$ ,  $1 \leq y \leq 7$ ,  $x+y \leq 8$  for asymmetric multislot configuration

The assignment of channels to a Multislot Configuration must always consider the multislot capability of the MS, as defined by the multislot class described in annex B.

##### 6.4.2.4.3 TCHs and PDTCHs assigned

Multislot configurations for DBPSCH may consist of a mixed assignment of TCHs and PDTCHs. The multislot configurations for TCH and PDTCH on DBPSCH in *lu mode* are defined in sections 6.4.2.4.1 and 6.4.2.4.2.

##### 6.4.2.5 void

#### 6.4.2.6 Multislot configurations for SBPSCH in *lu mode*

The multislot configurations for SBPSCH in *lu mode* are equivalent to the multislot configurations for packet switched connections in *A/Gb mode*, which are defined in section 6.4.2.2.

#### 6.4.2.7 Multislot configurations for dual transfer mode in *lu mode*

For dual transfer mode in *lu mode*, a multislot configuration comprises one or more DBPSCHs and one or more SBPSCH/F. The mobile station shall support every combination of these basic physical subchannels consistent with its multislot capability signalled to the GERAN (See TS 44.118).

The network shall leave a gap of at least one radio block between the old and the new configuration, when the assignment is changed and SBPSCHs with the lowest numbered timeslot are not the same in the old and new configuration. For multislot class type 1 MS, the gap shall be left in both uplink and downlink when the lowest numbered timeslot for the combined uplink and downlink configuration is changed.

## 6.5 Operation of channels and channel combinations

### 6.5.1 General

- i) A base transceiver station must transmit a burst in every timeslot of every TDMA frame in the downlink of radio frequency channel C0 of the cell allocation (to allow mobiles to make power measurements of the radio frequency channels supporting the BCCH, see 3GPP TS 45.008). In order to achieve this requirement a dummy burst is defined in subclause 5.2.6 which shall be transmitted by the base transceiver station on all timeslots of all TDMA frames of radio frequency channel C0 for which no other channel requires a burst to be transmitted.
- ii) Timeslot number 0 of radio frequency channel C0 of the cell allocation must support either channel combinations iv), v) or xxxviii) in subclause 6.4.1. No other timeslot or allocated channel from the cell allocation is allowed to support channel combinations iv), v) and xxxviii) in subclause 6.4.1.
- iii) The parameter BS\_CC\_CHANS in the BCCH defines the number of basic physical channels supporting common control channels (CCCHs). All shall use timeslots on radio frequency channel C0 of the cell allocation. The first CCCH shall use timeslot number 0, the second timeslot number 2, the third timeslot number 4 and the fourth timeslot number 6. Each CCCH carries its own CCCH\_GROUP of mobiles in idle mode. Mobiles in a specific CCCH\_GROUP will listen for paging messages and make random accesses only on the specific CCCH to which the CCCH\_GROUP belongs. The method by which a mobile determines the CCCH\_GROUP to which it belongs is defined in subclause 6.5.2.
- iv) The parameter BS\_CCCH\_SDCCH\_COMB in the BCCH (see subclause 3.3.2) defines whether the common control channels defined are combined with SDCCH/4(0.3) + SACCH/C4(0.3) onto the same basic physical channel. If they are combined then the number of available random access channel blocks (access grant channel blocks and paging channel blocks; see following), are reduced as defined in table 5 of clause 7.
- v) The PCH, AGCH, NCH and BCCH Ext may share the same TDMA frame mapping (considered modulo 51) when combined onto a basic physical channel. The channels are shared on a block by block basis, and information within each block, when de-interleaved and decoded allows a mobile to determine whether the block contains paging messages, notification message, system information messages or access grants. However, to ensure a mobile satisfactory access to the system a variable number of the available blocks in each 51-multiframe can be reserved for access grants and system information messages, only. The number of blocks not used for paging (BS\_AG\_BLK\_RES) starting from, and including block number 0 is broadcast in the BCCH (see subclause 3.3.2). As above the number of paging blocks per 51-multiframe considered to be "available" shall be reduced by the number of blocks reserved for access grant messages.

The number of paging blocks per 51-multiframe shall be the same for all cells in a routing area where eDRX is supported to ensure the nominal paging group of a MS that uses eDRX (see 3GPP TS 44.018 [10]) occurs at the same location (i.e. in the same paging block) within the set of 51-multiframes comprising its eDRX cycle in all cells in that routing area.

If system information messages are sent on BCCH Ext, BS\_AG\_BLK\_RES shall be set to a value greater than zero.

Table 5 of clause 7 defines the access grant blocks and paging blocks available per 51-multiframe.

- vi) Another parameter in the BCCH, BS\_PA\_MFRMS indicates the number of 51-multiframes between transmissions of paging messages to mobiles in idle mode of the same paging group. The "available" paging blocks per CCCH are then those "available" per 51-multiframe on that CCCH (determined by the two above parameters) multiplied by BS\_PA\_MFRMS. An exception case is where eDRX is supported in a given routing area in which case all cells therein shall have the same number of paging blocks per 51-multiframe (see 3GPP TS 44.018 [10]). In this exception case the "available" paging blocks per eDRX cycle on a CCCH is determined by multiplying the number of paging blocks per 51-multiframe by the number of 51-multiframes per eDRX cycle (BS\_ePA\_MFRMS) (see Table 6.5.6a-1). Mobiles are normally only required to monitor every Nth block of their paging channel, where N equals the number of "available" blocks in total

(determined by the above BCCH parameters) on the paging channel of the specific CCCH which their CCCH\_GROUP is required to monitor. Note that when eDRX is used then N is determined using BS\_ePA\_MFRMS which is not a parameter sent on the BCCH but is derived directly from the eDRX cycle length negotiated by the mobile station with the network (see sub-clause 6.5.2a and Table 6.5.6a-1). Other paging modes (e.g. page reorganize or paging overload conditions described in 3GPP TS 44.018) may require the mobile to monitor paging blocks more frequently than this. All the mobiles listening to a particular paging block are defined as being in the same PAGING\_GROUP. The method by which a particular mobile determines to which particular PAGING\_GROUP it belongs and hence which particular block of the available blocks on the paging channel is to be monitored is defined in subclause 6.5.2 and 6.5.2a.

- vii) An MS which has its membership of at least one voice group or voice broadcast call group set to the active state shall, in addition to monitoring the paging blocks as described above, monitor the notification channel, NCH. This logical channel is always mapped onto contiguous blocks reserved for access grants, in a position and number as given by the parameter NCP, defined in 3GPP TS 44.018, broadcast on the BCCH. The channel may be present when a cell supports voice group or voice broadcast calls. The coding of the various structural parameters described above in this subclause is not changed. Information within a block, when deinterleaved and decoded, allows the MS to determine whether the block contains access grant messages or notification messages.
- viii) In presence of PCCCH, the parameter BS\_PCC\_CHANS in the PBCCH defines the number of physical channels for packet data (PDCH) carrying PCCCH. The (P)BCCH shall in addition indicate the physical description of those channels. Each PCCCH carries its own PCCCH\_GROUP of MSs in GPRS attached mode. MS in a specific PCCCH\_GROUP will listen for paging messages and make random accesses only on the specific PCCCH to which the PCCCH\_GROUP belongs. The method by which an MS determines the PCCCH\_GROUP to which it belongs is defined in subclause 6.5.6.
- ix) In CTS, the CTSBCH (CTSBCH-SB and CTSBCH-FB) shall always be transmitted by the CTS-FP according to the rules defined in Clause 6 and table 8 of clause 7.

In CTS idle mode, a CTS-MS shall be assigned a CTS\_PAGING\_GROUP, as specified in subclause 6.5.7. Several CTS-MS can be assigned the same CTS\_PAGING\_GROUP. The CTS-MS shall determine the specific 52-multiframe where a paging block may be sent to it according to the rule defined in subclause 6.5.7, and shall listen to the CTSBCH of the previous 52-multiframe. In this 52-multiframe, the CTS-MS shall decode the CTSBCH-SB information bits : if the flag indicating the presence of a CTSPCH in the next 52-multiframe is properly set (see 3GPP TS 44.056), the CTS-MS shall listen to the next CTSPCH and read the paging block. With this method, it is not necessary to maintain on the physical channel the CTSPCH : the CTSPCH shall only be transmitted when a paging message shall be addressed to one or several CTS-MS in a CTS paging group.

When using the CTSARCH, the CTS-MS shall send two bursts on the CTSARCH: these two bursts shall be sent on two successive frames and shall fulfil the mapping defined in table 8 of clause 7, with the requirement of the first burst being sent in a TDMA frame with even FN. They shall contain the same access request message, which is specified in 3GPP TS 44.056. The first sent burst can be used by the CTS-FP to assess the path loss between the CTS-MS and itself, in order to effectively decode the second burst.

- x) For COMPACT, the base transceiver station shall transmit a burst in a PDCH allocated to carry CPBCCH, in all TDMA Frames where CPBCCH, CFCCH, CSCH is allocated or where CPPCH can appear. In TDMA Frames where CPPCH can appear on the physical channel where CPBCCH is allocated, the base transceiver station shall transmit a dummy block in case no block is required to be transmitted.
- xi) For COMPACT, a base station does not transmit a burst in every timeslot of every TDMA frame in the downlink of the COMPACT control carrier (i.e., discontinuous transmission is used).
- xii) For COMPACT, inter base station time synchronization is required. Timeslot number (TN) = i (i = 0 to 7) and frame number (FN) with FN mod 208 = 0 shall occur at the same time in all cells.
- xiii) For the primary COMPACT carrier, timeslot numbers (TN) 1, 3, 5, and 7 shall support channel combination xxii) in subclause 6.4.1. TNs 0, 2, 4, and 6 shall support channel combination xiii).
- xiv) For the secondary COMPACT carrier(s) carrying CPCCCH, timeslot numbers (TN) 1, 3, 5, and 7 shall support channel combination xxiii) in subclause 6.4.1. TNs 0, 2, 4, and 6 shall support channel combination xiii). CPCCCHs on secondary COMPACT carrier(s) shall be allocated on same time group as for primary COMPACT carrier.

- xv) For the secondary COMPACT carrier(s) not carrying CPCCCH, timeslot numbers (TN) 0 through 7 shall support channel combination xiii) in subclause 6.4.1.
- xvi) For COMPACT, BS\_PAG\_BLKs\_RES shall be less than or equal to 8 and less than or equal to 10-BS\_PBCCH\_BLKs.
- xvii) For COMPACT, CFCCH, CSCH, CPBCCH, and CPCCCH are rotated as described in subclause 6.3.2.1. PDTCH, PACCH, and PTCCH do not rotate.
- xviii) For COMPACT, the parameters NIB\_CCCH\_0, NIB\_CCCH\_1, NIB\_CCCH\_2, and NIB\_CCCH\_3 shall not be broadcast for a serving time group.
- xix) For the COMPACT, NIB\_CCCH\_0, NIB\_CCCH\_1, NIB\_CCCH\_2, and NIB\_CCCH\_3 blocks shall be idle for non-serving time groups and rotate in accordance with the non-serving time groups.

The downlink position of the NIB\_CCCH idle blocks is based on the ordered list as defined in subclause 6.3.2.1. The MS shall ignore these downlink idle blocks and shall interpret this action as not having detected an assigned USF value on an assigned PDCH.

- xx) For COMPACT large cells, NIB\_CCCH\_0, NIB\_CCCH\_1, NIB\_CCCH\_2, and NIB\_CCCH\_3 blocks shall be idle on timeslots immediately preceding and succeeding non-serving time groups and rotate in accordance with the non-serving time groups. The MS shall ignore these downlink idle blocks and shall interpret this action as not having detected an assigned USF value on an assigned PDCH.

The downlink position of the NIB\_CCCH idle blocks is based on the ordered list as defined in subclause 6.3.2.1.

- xxi) For COMPACT, the MS attempts uplink random access on its designated serving time group (TG) by monitoring for USF=FREE in every downlink block.

For dynamic allocation, while in the uplink transfer state, the MS monitors all of the downlink non-idle blocks of its assigned PDCH for uplink assignments. The MS shall ignore downlink idle blocks and shall interpret this action as not having detected an assigned USF value on an assigned PDCH.

USF should be set equal to FREE for downlink non-idle blocks B0 on timeslot numbers (TN) 1, 3, 5, and 7.

- xxii) While in broadcast/multicast receive mode (see 3GPP TS 45.008), the MS shall continue to monitor system information either on the BCCH or, if present, on the PBCCH unless the network has indicated that system information and paging messages are sent on the PACCH for the MBMS radio bearer the MS listens to. If the network has not indicated that system information and paging messages are sent on the PACCH, or if the MS does not have an MS\_ID, the MS shall additionally read paging messages either from the CCCH or, if the PBCCH is present, from the PCCCH. The MS shall then monitor the same paging group as in packet idle mode, i.e. shall determine the paging blocks to monitor using the methods described in subclause 6.5.2 or subclause 6.5.6. If the location of the MBMS radio bearer with respect to the control channels does not allow the mobile station to satisfy this requirement, the mobile station shall not read those radio blocks of the MBMS radio bearer that would prevent the monitoring of its paging group on the paging channel(s).
- xxiii) For a mobile in DL-MC configuration, fallback to reception of a single carrier, irrespective of the number of assigned carriers, is performed with regular periodicity. The periodicity is based on BS\_PA\_MFRMS, which indicates the number of 52-multiframes between two fallback periods. A mobile belongs to a particular single carrier fallback group which identifies a specific basic radio block period, or in case of RTTI mode two consecutive reduced radio block periods, within the set of "available" single carrier fallback blocks, during which it performs single carrier fallback. The single carrier fallback applies to all assigned PDCHs (or PDCH pairs, in case of RTTI mode) on the carrier where single carrier fallback is performed.

The method by which a particular mobile determines to which single carrier fallback group it belongs is defined in subclause 6.5.8. Single carrier fallback is performed on the carrier where the PTCCH is assigned. In case no PTCCH is assigned the single carrier fallback is performed on the carrier with the lowest number (see 3GPP TS 44.060 for numbering of carriers). Irrespective of which carrier is used, the single carrier fallback applies to all assigned PDCHs (in BTTI configuration)/PDCH-pairs (in RTTI configuration) on that carrier. In case of inter-band reception, the single carrier fallback only applies in one frequency band.

- xxiv) For EC-GSM-IoT, timeslot number 1 of radio frequency channel C0 of the cell allocation must support channel combination xxxvii) in subclause 6.4.1. No other timeslot or allocated channel from the cell allocation is allowed to support channel combination xxxvii).

- xxv) For EC-GSM-IoT, the parameter EC\_BS\_CC\_CHANS in the EC SI on EC-BCCH defines the number of basic physical channels supporting extended coverage common control channels (EC-CCCHs). All shall use timeslots on radio frequency channel C0 of the cell allocation and shall support channel combination xxxvii) (timeslot number 1) or xxxix) (timeslot number 3,5, or 7) in subclause 6.4.1. The first EC-CCCH shall use timeslot number 1, the second timeslot number 3, the third timeslot number 5 and the fourth timeslot number 7. Each EC-CCCH carries its own EC\_CCCH\_GROUP of mobiles in idle mode. Mobiles in a specific EC\_CCCH\_GROUP will listen for paging messages and make random accesses only on the specific EC-CCCH to which the EC\_CCCH\_GROUP belongs. In case 2 TS EC-RACH mapping is configured by the network in EC SI (see 3GPP TS 44.018), the physical resources where the EC-RACH is mapped for CC2, CC3, CC4 and CC5 shall be the physical channel used by EC\_CCCH\_GROUP and one timeslot number lower, see table 6a. In this case the network shall ensure that channel combination xxxviii) is used on the lower timeslot number. The method by which a mobile determines the EC\_CCCH\_GROUP to which it belongs is defined in subclause 6.5.2b. In case the RACH is used (RACH Access Control in 3GPP TS 44.018) by a MS in EC operation, then channel combination shall be used xxxviii), and timeslot number 0 shall be used.
- xxvi) For EC-GSM-IoT, the EC-AGCH and EC-PCH may share the same TDMA frame mapping (considered modulo 51) when combined onto a basic physical channel. The channels are shared on a block by block basis, and information within each block, when de-interleaved and decoded allows a mobile to determine whether the block contains paging messages or access grants. Table 6a of clause 7 defines the access grant blocks and paging blocks available per 51-multiframe for each Coverage Class respectively. For a given Coverage Class, the same number of paging blocks are always available per 51-multiframe. The number of access grant blocks can differ depending on if the basic physical channel for EC-CCCH is timeslot number 1 or not.
- xxvii) For EC-GSM-IoT, the "available" paging blocks per eDRX cycle on an EC-CCCH is Coverage Class specific. It is determined by BS\_ePA\_MFRMS, see Table 6.5.6a-1, and the downlink Coverage Class of the MS, see subclause 6.5.2b. A mobile station selects one of the "available" paging blocks per eDRX cycle as its PAGING\_GROUP based on IMSI. All MSs belonging to the same Coverage Class, using the same eDRX cycle and that has selected the same paging block are defined as being in the same PAGING\_GROUP. The method by which a particular mobile determines to which particular PAGING\_GROUP it belongs and hence which particular block of the "available" paging blocks on the paging channel is to be monitored is defined in subclause 6.5.2b.

## 6.5.2 Determination of CCCH\_GROUP and PAGING\_GROUP for MS in idle mode

This sub-clause applies to the case where a MS is not using extended DRX cycles.

$$\text{CCCH\_GROUP} (0 \dots \text{BS\_CC\_CHANS}-1) = ((\text{IMSI} \bmod 1000) \bmod (\text{BS\_CC\_CHANS} \times N)) \text{div } N$$

$$\text{PAGING\_GROUP} (0 \dots N-1) = ((\text{IMSI} \bmod 1000) \bmod (\text{BS\_CC\_CHANS} \times N)) \bmod N$$

where

N = number of paging blocks "available" on one CCCH = (number of paging blocks "available" in a 51-multiframe on one CCCH) x BS\_PA\_MFRMS.

IMSI = International Mobile Subscriber Identity, as defined in 3GPP TS 23.003.

mod = Modulo.

div = Integer division.

### 6.5.2a Determination of CCCH\_GROUP, PAGING\_GROUP\_MF and PAGING\_GROUP\_PCH for MS in idle mode when using extended DRX cycles

The CCCH on which a MS will listen for paging messages and make random accesses is determined by CCCH\_GROUP, defined by:



$$\text{CCCH\_GROUP} (0 \dots \text{BS\_CC\_CHANS}-1) = (I \text{ div } M) \text{ mod } \text{BS\_CC\_CHANS}$$

where

$\text{BS\_CC\_CHANS}$  = Number of CCCHs, ranges from 1 to 4, determined using  $\text{CCCH\_CONF}$  broadcast in SI.

$I$  = IMSI mod 10000000 (IMSI defined in 3GPP TS 23.003)

$M$  = Number of 51-MF per negotiated eDRX Cycle =  $\text{BS\_ePA\_MFRMS}$  (see Table 6.5.6a-1)

The 51-multiframe where the paging group occurs on the applicable  $\text{CCCH\_GROUP}$  is determined by:

$$\text{PAGING\_GROUP\_MF} (0 \dots M-1) = I \text{ mod } M$$

The paging group within the 51-multiframe is determined by:

$$\text{PAGING\_GROUP\_PCH} (0 \dots L-1) = (I \text{ div } (\text{BS\_CC\_CHANS} \times M)) \text{ mod } L \text{ where}$$

$L$  = number of paging blocks per 51-MF, determined using  $\text{BS\_AG\_BLKS\_RES}$  broadcast in SI.

The paging group within the negotiated eDRX cycle is derived according to:

$$\text{PAGING\_GROUP} (0 \dots N-1) = L \times \text{PAGING\_GROUP\_MF} + \text{PAGING\_GROUP\_PCH}$$

where

$N$  = number of paging groups on one CCCH within a given eDRX cycle =  $\text{BS\_ePA\_MFRMS} \times L$  (see Table 6.5.6a-1).

The procedure for when the MS shall monitor the CCCH is described in 3GPP TS 44.018.

For determination of specific paging multiframe and paging block index when using extended DRX cycles, see subclause 6.5.3b.

## 6.5.2b Determination of $\text{EC\_CCCH\_GROUP}$ and $\text{PAGING\_GROUP}$ for MS in idle mode for EC-GSM-IoT

The EC-CCCH on which a MS will listen for paging messages and make random accesses is determined by  $\text{EC\_CCCH\_GROUP}$ , defined by:

$$\text{EC\_CCCH\_GROUP} (0 \dots \text{EC\_BS\_CC\_CHANS}-1) = (I \text{ div } M) \text{ mod } \text{EC\_BS\_CC\_CHANS}$$

where

$\text{EC\_BS\_CC\_CHANS}$  = Number of EC-CCCHs, ranges from 1 to 4, broadcast in EC SI.

$I$  = IMSI mod 10000000 (IMSI defined in 3GPP TS 23.003)

$M$  = Number of 51-multiframes per negotiated eDRX Cycle =  $\text{BS\_ePA\_MFRMS}$  (see Table 6.5.6a-1)

The paging group is determined by the eDRX value and the downlink Coverage Class.

The 51-multiframe where the paging group occurs on the applicable  $\text{EC\_CCCH\_GROUP}$  is determined by:

$$\text{EC\_PAGING\_GROUP\_MF} (0 \dots M-1) = I \text{ mod } M$$

The paging group within the 51-multiframe is determined by:

$$\text{EC\_PAGING\_GROUP\_PCH} (0 \dots L-1) = (I \text{ div } (\text{EC\_BS\_CC\_CHANS} \times M)) \text{ mod } L$$

where

$L$  = 16 (number of CC1 paging groups per 51-multiframe)

The paging group within the negotiated eDRX cycle is derived by first assuming downlink Coverage Class 1 (CC1), irrespective of the downlink CC selected by the MS according to:

$$\text{PAGING\_GROUP\_CC1} (0 \dots N-1) = L \times \text{EC\_PAGING\_GROUP\_MF} + \text{EC\_PAGING\_GROUP\_PCH}$$

where

$$N = \text{number of paging groups for CC1 on one EC-CCCH within a given eDRX cycle} = \text{BS\_ePA\_MFRMS} \times 16 \text{ (see Table 6.5.6a-1).}$$

In case the MS belongs to another downlink coverage class than CC1 (i.e. CC2, CC3 or CC4), the paging group shall be derived assuming that the physical resource of PAGING\_GROUP\_CC1 is contained within the physical resource of PAGING\_GROUP for the downlink CC selected by the MS and is derived per Coverage Class according to the procedures below.

For CC1:

$$\text{PAGING\_GROUP} (0 \dots M-1) = \text{PAGING\_GROUP\_CC1}$$

For CC2:

$$\text{PAGING\_GROUP} (0 \dots M-1) = (\text{PAGING\_GROUP\_CC1} \text{ div } 4) \text{ mod } 4 + 4 \times (\text{PAGING\_GROUP\_CC1} \text{ div } 32)$$

For CC3:

$$\text{PAGING\_GROUP} (0 \dots M-1) = (\text{PAGING\_GROUP\_CC1} \text{ div } 8) \text{ mod } 2 + 2 \times (\text{PAGING\_GROUP\_CC1} \text{ div } 32)$$

For CC4:

$$\text{PAGING\_GROUP} (0 \dots M-1) = (\text{PAGING\_GROUP\_CC1} \text{ div } 8) \text{ mod } 2 + 2 \times (\text{PAGING\_GROUP\_CC1} \text{ div } 64)$$

where

$$M = N \text{ div } \text{CC\_DIV}$$

**Table 6.5.2-1. CC\_DIV.**

CC1	CC2	CC3	CC4
1	8	16	32

The procedure for when the MS shall monitor the EC-CCCH is described in 3GPP TS 44.018.

Example assuming a single EC-CCCH: a MS that uses eDRX, where eDRX cycle value = "0000" (BS\_ePA\_MFRMS=8) has been negotiated between the MS and the network (see Table 6.5.6a-1), and that belongs to CC4, will first derive PAGING\_GROUP\_CC1 according to  $16 \times (I \text{ mod } 8) + (I \text{ div } 8) \text{ mod } 16$  where  $I = \text{IMSI} \text{ mod } 10000000$ . As a second step the PAGING\_GROUP for the applicable downlink coverage class (CC4) is derived as  $(\text{PAGING\_GROUP\_CC1} \text{ div } 8) \text{ mod } 2 + 2 \times (\text{PAGING\_GROUP\_CC1} \text{ div } 64)$ .

For determination of specific paging multiframe and paging block index for EC-GSM-IoT, see subclause 6.5.3a.

### 6.5.3 Determination of specific paging multiframe and paging block index

This sub-clause applies to the case where a MS is not using extended DRX cycles.

The required 51-multiframe occurs when:

$$\text{PAGING\_GROUP} \text{ div } (N \text{ div } \text{BS\_PA\_MFRMS}) = (\text{FN} \text{ div } 51) \text{ mod } (\text{BS\_PA\_MFRMS})$$

The index to the required paging block of the "available" blocks in the 51-multiframe:

$$\text{Paging block index} = \text{PAGING\_GROUP} \text{ mod } (N \text{ div } \text{BS\_PA\_MFRMS})$$

where the index is then used with the look-up table 5 of clause 7 to determine the actual paging channel interleaved block to be monitored.

In GPRS non-DRX mode, the MS shall listen to all blocks of the CCCH channel.

## 6.5.3a Determination of specific paging multiframe and paging block index for EC-GSM-IoT

### 6.5.3a.1 CC1

The 51-multiframe where the paging block is mapped for CC1 occurs when:

$$\text{PAGING\_GROUP div 16} = (\underline{\text{RFN}}_{\text{QH}} \text{ div 51}) \bmod (\text{BS\_ePA\_MFRMS})$$

where

$\underline{\text{RFN}}_{\text{QH}}$  is the TDMA frame number known with an accuracy of a quarter hyperframe (see sub-clause 3.3.2.2.3)

The index to the required paging block of the "available" blocks in the 51-multiframe:

$$\text{Paging block index} = \text{PAGING\_GROUP} \bmod 16$$

where the index is then used with the look-up table 6a of clause 7 (also illustrated in figure 13) to determine the actual paging channel interleaved block to be monitored.

### 6.5.3a.2 CC2

The two 51-multiframes where the paging block is mapped for CC2 occurs when:

$$\text{PAGING\_GROUP div 4} = (\underline{\text{RFN}}_{\text{QH}} \text{ div 102}) \bmod (\text{BS\_ePA\_MFRMS div 2})$$

The index to the required paging block of the "available" blocks in the 51-multiframe:

$$\text{Paging block index} = \text{PAGING\_GROUP} \bmod 4$$

where the index is then used with the look-up table 6a of clause 7 (also illustrated in figure 13) to determine the actual paging channel interleaved block to be monitored.

### 6.5.3a.3 CC3

The two 51-multiframes where the paging block is mapped for CC3 occurs when:

$$\text{PAGING\_GROUP div 2} = (\underline{\text{RFN}}_{\text{QH}} \text{ div 102}) \bmod (\text{BS\_ePA\_MFRMS div 2})$$

The index to the required paging block of the "available" blocks in the 51-multiframe:

$$\text{Paging block index} = \text{PAGING\_GROUP} \bmod 2$$

where the index is then used with the look-up table 6a of clause 7 (also illustrated in figure 13) to determine the actual paging channel interleaved block to be monitored.

### 6.5.3a.4 CC4

The four 51-multiframes where the paging block is mapped for CC4 occurs when:

$$\text{PAGING\_GROUP div 2} = (\underline{\text{RFN}}_{\text{QH}} \text{ div 204}) \bmod (\text{BS\_ePA\_MFRMS div 4})$$

The index to the required paging block of the "available" blocks in the 51-multiframe:

$$\text{Paging block index} = \text{PAGING\_GROUP} \bmod 2$$

where the index is then used with the look-up table 6a of clause 7 (also illustrated in figure 13) to determine the actual paging channel interleaved block to be monitored.

## 6.5.3b Determination of specific paging multiframe and paging block index when using extended DRX cycles

The 51-multiframe where the paging block is mapped occurs when:

$$\text{PAGING\_GROUP div } L = (\text{FN div } 51) \bmod (\text{BS\_ePA\_MFRMS})$$

The index to the required paging block of the "available" blocks in the 51-multiframe:

$$\text{Paging block index} = \text{PAGING\_GROUP} \bmod L$$

where the index is then used with the look-up table 5 of clause 7 (also illustrated in figure 13) to determine the actual paging channel interleaved block to be monitored.

### 6.5.3c Determination of EC-PICH block for EC-GSM-IoT

For CC4, two EC-PICH blocks occur in every four 51-multiframes and for CC3 one EC-PICH block occurs in every two 51-multiframes. The location of the EC-PICH blocks is specified in Table 6a.

The MS in CC4 coverage condition, after determining the four 51-multiframes where the paging block occurs and the paging block index within four 51-multiframes, as specified in subclause 6.5.3a4, monitors the EC-PICH block for a paging indication corresponding to its paging block, with the EC-PICH block occurring before the actual paging block. The mapping of EC-PICH block to the paging block number in four 51-multiframe is provided in Table 6.5.8-1.

**Table 6.5.8-1. Mapping of EC-PICH block to Paging block number for CC4**

TN Number of EC-CCCH	Paging block number	EC-PICH block number
1	0	B0 of same 4*51-multiframe of the paging block
1	1	B1 of same 4*51-multiframe of the paging block
3,5,7	0	B1 of the previous 4*51 multiframe of the 4*51 paging mutiframe of the pagin block
3,5,7	1	B0 of the same 4*51-multiframe of the paging block

The MS in CC3 coverage condition, after determining the two 51-multiframes where the paging block occurs and the paging block index within two 51-multiframes, as specified in subclause 6.5.3a3, monitors the EC-PICH block for a paging indication corresponding to its paging block, with the EC-PICH block occurring before the actual paging block. The EC-PICH block occurs in previous two 51-multiframes indicating the paging for both paging blocks.

### 6.5.4 Short Message Service Cell Broadcast (SMSCB)

When a short message service cell broadcast (SMSCB) message is to be sent, the message shall be sent on one of the two cell broadcast channels (CBCH): the basic and the extended cell broadcast channel in four consecutive multiframes using the block defined in table 3 of clause 7. The multiframes used for the basic cell broadcast channel shall be those in which TB = 0,1,2 and 3. The multiframes used for the extended cell broadcast channel shall be those in which TB = 4, 5, 6 and 7 where:

$$\text{TB} = (\text{FN DIV } 51) \bmod(8)$$

The SMSCB header shall be sent in the multiframe in which TB = 0 for the basic, and TB = 4 for the extended cell broadcast channel. When SMSCB is in use, this is indicated within the BCCH data (see 3GPP TS 44.018), and the parameter BS\_AG\_BLKS\_RES shall be set to one or greater. When the CBCH is mapped onto a CCCH+SDCCH/4 channel, use of SMSCB does not place any constraint on the value of BS\_AG\_BLKS\_RES.

NOTE 1: The MS reading of the extended CBCH is occasionally interrupted by MS idle mode procedures.

NOTE 2: For a certain network configuration the MS reading of the primary CBCH is occasionally interrupted by MS idle mode procedures when the MS is GPRS attached and in packet idle mode.

## 6.5.5 Voice group and voice broadcast call notifications

When mobile stations are to be alerted on a voice group or voice broadcast call, notification messages shall be sent on the notification channel (NCH), using the blocks defined in subclause 6.5.1.

When the NCH is in use, the parameter BS\_AG\_BLK\_RES shall be set to a value not lower than the number of blocks used for the NCH, see subclause 6.5.1 vii).

## 6.5.6 Determination of PCCCH\_GROUP and PAGING\_GROUP for MS in GPRS attached mode

This sub-clause applies to the case where a MS is not using extended DRX cycles.

If PCCCH is present, then it shall be used in the GPRS attached mode for paging and access. It shall also be used by an MS performing the GPRS attach procedure for access and monitoring of network response. In absence of PCCCH, CCCH shall be used for paging and access. If the determination of the specific paging multiframe and paging block index as specified in this subclause is not supported on CCCH by both the MS and the BTS, the method defined in subclause 6.5.2 and 6.5.3 shall be used. This is negotiated at GPRS attach.

$$\text{PCCCH\_GROUP} (0 \dots \text{KC}-1) = ((\text{IMSI mod } 1000) \text{ mod } (\text{KC} * \text{N})) \text{ div } \text{N}$$

$$\begin{aligned} \text{PAGING\_GROUP} (0 \dots \text{M}-1) = & (( (\text{IMSI mod } 1000) \text{ div } (\text{KC} * \text{N})) * \text{N} + \\ & (\text{IMSI mod } 1000) \text{ mod } \text{N} + \\ & \text{Max}((\text{m} * \text{M}) \text{ div } \text{SPLIT\_PG\_CYCLE}, \text{m})) \text{ mod } \text{M} \\ & \text{for } \text{m} = 0, \dots, \text{Min}(\text{M}, \text{SPLIT\_PG\_CYCLE}) - 1 \end{aligned}$$

where

KC = number of (P)CCCH in the cell =

BS\_PCC\_CHANS for PCCCH  
BS\_CC\_CHANS for CCCH

M = number of paging blocks "available" on one (P)CCCH =  
(12 - BS\_PAG\_BLK\_RES - BS\_PBCCH\_BLK) \* 64 for PCCCH  
(9 - BS\_AG\_BLK\_RES) \* 64 for CCCH not combined  
(3 - BS\_AG\_BLK\_RES) \* 64 for CCCH + SDCCH combined

N =

1 for PCCCH

(9 - BS\_AG\_BLK\_RES) \* BS\_PA\_MFRMS for CCCH not combined  
(3 - BS\_AG\_BLK\_RES) \* BS\_PA\_MFRMS for CCCH/SDCCH combined

SPLIT\_PG\_CYCLE is an MS specific parameter negotiated at GPRS attach (see 3GPP TS 44.060)

IMSI = International Mobile Subscriber Identity, as defined in 3GPP TS 23.003.

mod = Modulo.

div = Integer division.

The MS shall receive paging and perform access on a single (P)CCCH identified by the PCCCH\_GROUP parameter (see subclause 6.5.1).

In non-DRX mode, depending whether there is or not PCCCH channel(s) in the cell, the MS shall listen :

- to all M blocks per multiframe where paging may appear on a PCCCH channel, or
- to all blocks on a CCCH channel.

In DRX mode, the MS shall listen to the blocks corresponding to its paging group as defined by the different PAGING\_GROUP values.

The required multiframe occurs when:

$$\text{PAGING\_GROUP div (M div 64)} = (\text{FN div MFL}) \bmod 64$$

where

$$\text{MFL} = \text{multiframe length} = 51 \text{ for CCCH or } 52 \text{ for PCCCH}$$

The index to the required paging block of the "available" blocks in the multiframe:

$$\text{Paging block index} = \text{PAGING\_GROUP} \bmod (\text{M div 64})$$

where the index is then used with look-up tables of clause 7 to determine the actual PPCH block to be monitored. Table 5 is used for CCCH and table 7 for PCCCH.

For CCCH, if  $\text{SPLIT\_PG\_CYCLE} > 32$  is negotiated,  $\text{SPLIT\_PG\_CYCLE} = 32$  shall be used, in order to provide the MS enough time for BSIC and System Information decoding.

NOTE: On BCCH, the operator should limit  $\text{DRX\_TIMER\_MAX}$  (see 3GPP TS 44.060) to 4 seconds of the same reason.

### 6.5.6a Determination of extended DRX cycle for MS in GPRS attached mode

A MS that uses eDRX (see 3GPP TS 44.018 [10]) indicates an eDRX cycle value from Table 6.5.6a-1 when negotiating eDRX with the network (see 3GPP TS 24.008 [21] and 3GPP TS 23.060 [22]). After power on and cell selection but before negotiating an eDRX cycle with the network a MS is not required to monitor the (EC-)PCH. After cell reselection from a cell where eDRX was used but before acquiring System Information in the new cell a MS shall monitor the (EC-)PCH according to its last negotiated eDRX cycle.

**Table 6.5.6a-1: Set of eDRX Cycles Supported**

eDRX cycle value	eDRX cycle length	Number of 51-MF per eDRX cycle (BS_ePA_MFRMS)	eDRX cycles per hyperframe
0000	~1.9 seconds	8	6656
0001	~3.8 seconds	16	3328
0010	~7.5 seconds	32	1664
0011	~12.2 seconds	52	1024
0100	~24.5 seconds	104	512
0101	~49 seconds	208	256
0110	~1.63 minutes	416	128
0111	~3.25 minutes	832	64
1000	~6.5 minutes	1664	32
1001	~13 minutes	3328	16
1010	~26 minutes	6656	8
1011	~52 minutes	13312	4

Note 1: 53248 51-multiframes occur with the TDMA FN space (2715648 TDMA frames)  
Note 2: All remaining eDRX Cycle Values are reserved

### 6.5.7 Determination of CTS\_PAGING\_GROUP and specific paging 52-multiframe for MS in CTS mode

$$\text{CTS\_PAGING\_GROUP} = (\text{CTS-MSI} \bmod N)$$

where:

CTS-MSI = CTS Mobile Subscriber Identity as defined in 3GPP TS 23.003

N = number of CTS paging groups defined in the CTS-FP and given to the CTS-MS during the attachment procedure (see 3GPP TS 44.056).

The required 52-multiframe where a paging message may be sent to the CTS-MS occurs when:

$$(FN \text{ div } 52) \text{ mod } N = \text{CTS\_PAGING\_GROUP}$$

## 6.5.8 Determination of single carrier fallback group

For a mobile in DLMC configuration the single carrier fallback group is determined by:

$$\text{SINGLE\_CARRIER\_FALLBACK\_GROUP} (0 \dots N-1) = (\text{TLLI mod } 1000) \text{ mod } N$$

The specific 52-multiframe during which an MS applies single carrier fallback occurs when:

$$\text{SINGLE\_CARRIER\_FALLBACK\_GROUP div } (N \text{ div } \text{BS\_PA\_MFRMS}) = (FN \text{ div } 52) \text{ mod } (\text{BS\_PA\_MFRMS})$$

The required single carrier fallback block index is the specific basic radio block period (in case of RTTI configuration, the basic radio block period corresponds to two consecutive RTTI radio block periods) in the specific 52-multiframe during which an MS applies single carrier fallback and occurs when:

$$\text{Single carrier fallback block index} = \text{SINGLE\_CARRIER\_FALLBACK\_GROUP mod } (N \text{ div } \text{BS\_PA\_MFRMS})$$

where

$N$  = number of single carrier fallback blocks "available" on one PDTCH = (number of single carrier fallback blocks "available" in a 52-multiframe on one PDTCH) x  $\text{BS\_PA\_MFRMS}$ .

Number of single carrier fallback blocks "available" in a 52-multiframe on one PDTCH = 12.

TLLI = Temporary Logical Link Identity, as defined in 3GPP TS 23.003.

mod = Modulo.

div = Integer division.

## 7 Mapping tables

**Table 1 : Mapping of logical channels onto physical channels (see subclauses 6.3, 6.4, 6.5)**

Channel designation	Sub-channel number	Direction assignments	Allowable time slot assignments	Allowable RF channel type	Burst in TDMA frames	Repeat length	Interleaved block TDMA frame mapping
TCH/FS, TCH/EFS, TCH/AFS, TCH/F2.4, TCH/WFS & O-TCH/WFS	D&U <sup>2</sup>	0 ... 7	C0 ... Cn	NB <sup>1</sup>	13B0(0...7),B1(4...11),B2(8...11,0...3)		
TCH/HS, TCH/AHS, O-TCH/AHS & O-TCH/WHS	0 1	D&U <sup>2</sup>	0 ... 7 B0(1,3,5,7),B1(5,7,9,11),B2(9,11,1,3)	C0 ... Cn	NB <sup>1</sup>	13	B0(0,2,4,6),B1(4,6,8,10),B2(8,10,0,2)
FACCH/F & O-FACCH/F	D&U	0 ... 7	C0 ... Cn	NB <sup>1</sup>	13B0(0...7),B1(4...11),B2(8...11,0...3)		
FACCH/H & O-FACCH/H	0	U	0 ... 7	C0 ... Cn	NB <sup>1</sup>	26	B0(0,2,4,6,8,10),B1(8,10,13,15,17,19),B2(17,19,21,23,0,2)
FACCH/H & O-FACCH/H	0	D	0 ... 7	C0 ... Cn	NB <sup>1</sup>	26	B0(4,6,8,10,13,15),B1(13,15,17,19,21,23),B2(21,23,0,2,4,6)
FACCH/H & O-FACCH/H	1	U	0 ... 7	C0 ... Cn	NB <sup>1</sup>	26	B0(1,3,5,7,9,11),B1(9,11,14,16,18,20),B2(18,20,22,24,1,3)
FACCH/H & O-FACCH/H	1	D	0 ... 7	C0 ... Cn	NB <sup>1</sup>	26	B0(5,7,9,11,14,16),B1(14,16,18,20,22,24),B2(22,24,1,3,5,7)
E-FACCH/F	D&U	0 ... 7	C0 ... Cn	NB <sup>1</sup>	<sup>13</sup> B0(0...3),B1(4...7),B2(8...11)		
E-IACCH/F	D&U	0 ... 7	C0 ... Cn	26	B0(0 ... 3)B1(4 ... 7)B2(8 ... 11)B3(13 ... 16)		
		B4(17 ... 20)B5(21 ... 24)					
SACCH/TF & SACCH/TPF	D&U <sup>2</sup>	0	C0 ... Cn	NB <sup>3</sup>	104	B(12, 38, 64, 90)	NOTE 1:
SACCH/TF & SACCH/TPF	D&U <sup>2</sup>	1	C0 ... Cn	NB <sup>3</sup>	104	B(25, 51, 77, 103)	An Access Burst (AB) is used
SACCH/TF & SACCH/TPF	D&U <sup>2</sup>	2	C0 ... Cn	NB <sup>3</sup>	104	B(38, 64, 90, 12)	on the uplink during handover
SACCH/TF & SACCH/TPF	D&U <sup>2</sup>	3	C0 ... Cn	NB <sup>3</sup>	104	B(51, 77, 103, 25)	and on channels used for voice
SACCH/TF & SACCH/TPF	D&U <sup>2</sup>	4	C0 ... Cn	NB <sup>3</sup>	104	B(64, 90, 12, 38)	group calls when a request to
SACCH/TF & SACCH/TPF	D&U <sup>2</sup>	5	C0 ... Cn	NB <sup>3</sup>	104	B(77, 103, 25, 51)	talk is made.
SACCH/TF & SACCH/TPF	D&U <sup>2</sup>	6	C0 ... Cn	NB <sup>3</sup>	104	B(90, 12, 38, 64)	



SACCH/TF & SACCH/TPF	D&U <sup>2</sup>	7	C0 ... Cn	NB <sup>3</sup>	104	B(103, 25, 51, 77)		
SACCH/M & SACCH/MP	D&U <sup>2</sup>	0 ... 7	C0 ... Cn	NB <sup>3</sup>	104	B(12, 38, 64, 90)		
SACCH/CTS	D&U	0, 1	C0 ... Cn	NB	104	B(12, 38, 64, 90)		
SACCH/CTS	D&U	2, 3	C0 ... Cn	NB	104	B(38, 64, 90, 12)		
SACCH/CTS	D&U	4, 5	C0 ... Cn	NB	104	B(64, 90, 12, 38)		
SACCH/CTS	D&U	6, 7	C0 ... Cn	NB	104	B(90, 12, 38, 64)		
SACCH/TH & SACCH/TPH	0	D&U <sup>2</sup>	0	C0 ... Cn	NB <sup>3</sup>	104	B(12, 38, 64, 90)	NOTE 2:
SACCH/TH & SACCH/TPH	1	D&U <sup>2</sup>	B(25, 51, 77, 103)	The uplink of a channel				
SACCH/TH & SACCH/TPH	0	D&U <sup>2</sup>	1	C0 ... Cn	NB <sup>3</sup>	104	B(12, 38, 64, 90)	used for voice broadcast
SACCH/TH & SACCH/TPH	1	D&U <sup>2</sup>	B(25, 51, 77, 103)	or a voice group call may				
SACCH/TH & SACCH/TPH	0	D&U <sup>2</sup>	2	C0 ... Cn	NB <sup>3</sup>	104	B(38, 64, 90, 12)	actually not be used.
SACCH/TH & SACCH/TPH	1	D&U <sup>2</sup>	B(51, 77, 103, 25)					
SACCH/TH & SACCH/TPH	0	D&U <sup>2</sup>	3	C0 ... Cn	NB <sup>3</sup>	104	B(38, 64, 90, 12)	
SACCH/TH & SACCH/TPH	1	D&U <sup>2</sup>	B(51, 77, 103, 25)					
SACCH/TH & SACCH/TPH	0	D&U <sup>2</sup>	4	C0 ... Cn	NB <sup>3</sup>	104	B(64, 90, 12, 38)	
SACCH/TH & SACCH/TPH	1	D&U <sup>2</sup>	B(77, 103, 25, 51)	NOTE 3:				
SACCH/TH & SACCH/TPH	0	D&U <sup>2</sup>	5	C0 ... Cn	NB <sup>3</sup>	104	B(64, 90, 12, 38)	An Access Burst (AB) may be
SACCH/TH & SACCH/TPH	1	D&U <sup>2</sup>	B(77, 103, 25, 51)	used on the uplink during				
SACCH/TH & SACCH/TPH	0	D&U <sup>2</sup>	6	C0 ... Cn	NB <sup>3</sup>	104	B(90, 12, 38, 64)	handover.
SACCH/TH & SACCH/TPH	1	D&U <sup>2</sup>	B(103, 25, 51, 77)					
SACCH/TH & SACCH/TPH	0	D&U <sup>2</sup>	7	C0 ... Cn	NB <sup>3</sup>	104	B(90, 12, 38, 64)	
SACCH/TH & SACCH/TPH	1	D&U <sup>2</sup>	B(103, 25, 51, 77)					
EPCCH/F	D&U <sup>2</sup>	0,2,4,6	C0 ... Cn	NB <sup>3</sup>	26	B0(12)		
EPCCH/F	D&U <sup>2</sup>	1,3,5,7	C0 ... Cn	NB <sup>3</sup>	26	B0(25)		
EPCCH/M	D&U <sup>2</sup>	0 ... 7	C0 ... Cn	NB <sup>3</sup>	26	B0(12)		
EPCCH/H	0	D&U <sup>2</sup>	0 ... 7	C0 ... Cn	NB <sup>3</sup>	26	B0(12)	
	1	D&U <sup>2</sup>	B0(25)					

**Table 1a: Mapping of logical channels onto physical channels (see subclause 6.3.1.1)**

Channel designation	Sub-channel number	Direction assignments	Allowable time slot assignments	Allowable RF channel type	Burst in TDMA frames	Repeat length in frames	Interleaved block TDMA frame mapping
TCH/FS, TCH/EFBS, TCH/AFS, TCH/WFS	D&U <sup>2</sup>	0, 2, 4, 6	C0 ... Cn	NB <sup>1</sup>	26B0(0...7),B1(4...11),B2(8...12,14...16),B3(12,14...20),		
							B4(17...24),B5(21...24,0..3)
TCH/FS, TCH/EFBS, TCH/AFS, TCH/WFS	D&U <sup>2</sup>	1, 3, 5, 7	C0 ... Cn	NB <sup>1</sup>	26B0(0...7),B1(4...11),B2(8...11,13...16),B3(13...20),		
							B4(17...23,25),B5(21...23,25,0..3)
TCH/HS, TCH/AHS	0	D&U <sup>2</sup>	0 ... 7	C0 ... Cn	NB <sup>1</sup>	26	B0(0, 2, 4, 6),B1(4, 6, 8, 10),B2(8, 10, 12, 15),
							B3(12, 15, 17,19),B4(17, 19, 21, 23),B5(21, 23, 0, 2)

	1		B0(1, 3, 5, 7),B1(5, 7, 9, 11),B2(9, 11, 14, 16), B3(14, 16, 18, 20),B4(18, 20, 22, 25),B5(22, 25, 1, 3)				
FACCH/F	D&U	0,2,4,6 B4(17...24),B5(21..24,0..3)	C0 ... Cn	NB <sup>1</sup>		26B0(0...7),B1(4...11),B2(8...12,14...16),B3(12,14...20),	
FACCH/F	D&U	1,3,5,7 B4(17...23,25),B5(21..23,25,0..3)	C0 ... Cn	NB <sup>1</sup>		26B0(0...7),B1(4...11),B2(8...11,13...16),B3(13...20),	
FACCH/H	0	U	0 ... 7	C0 ... Cn	NB <sup>1</sup>	26	B0(0,2,4,6,8,10),B1(8,10,12, 15,17,19),B2(17,19,21,23,0,2)
FACCH/H	0	D	0 ... 7	C0 ... Cn	NB <sup>1</sup>	26	B0(4,6,8,10,12, 15),B1(12,15,17,19,21,23),B2(21,23,0,2,4,6)
FACCH/H	1	U	0 ... 7	C0 ... Cn	NB <sup>1</sup>	26	B0(1,3,5,7,9,11),B1(9,11,14,16,18,20),B2(18,20,22,25,1,3)
FACCH/H	1	D	0 ... 7	C0 ... Cn	NB <sup>1</sup>	26	B0(5,7,9,11,14,16),B1(14,16,18,20,22,25),B2(22,25,1,3,5,7)
SACCH/TF & SACCH/TPF	D&U <sup>2</sup>	0	C0 ... Cn	NB <sup>3</sup>	104	B(13, 39, 65, 91)	
SACCH/TF & SACCH/TPF	D&U <sup>2</sup>	1	C0 ... Cn	NB <sup>3</sup>	104	B(24, 50, 76, 102)	
SACCH/TF & SACCH/TPF	D&U <sup>2</sup>	2	C0 ... Cn	NB <sup>3</sup>	104	B(39, 65, 91, 13)	
SACCH/TF & SACCH/TPF	D&U <sup>2</sup>	3	C0 ... Cn	NB <sup>3</sup>	104	B(50, 76, 102, 24)	
SACCH/TF & SACCH/TPF	D&U <sup>2</sup>	4	C0 ... Cn	NB <sup>3</sup>	104	B(65, 91, 13, 39)	
SACCH/TF & SACCH/TPF	D&U <sup>2</sup>	5	C0 ... Cn	NB <sup>3</sup>	104	B(76, 102, 24, 50)	
SACCH/TF & SACCH/TPF	D&U <sup>2</sup>	6	C0 ... Cn	NB <sup>3</sup>	104	B(91, 13, 39, 65)	
SACCH/TF & SACCH/TPF	D&U <sup>2</sup>	7	C0 ... Cn	NB <sup>3</sup>	104	B(102, 24, 50, 76)	
SACCH/M & SACCH/MP	D&U <sup>2</sup>	0 ... 7	C0 ... Cn	NB <sup>3</sup>	104	B(13, 39, 65, 91)	
SACCH/CTS	D&U	0, 1	C0 ... Cn	NB	104	B(13, 39, 65, 91)	
SACCH/CTS	D&U	2, 3	C0 ... Cn	NB	104	B(39, 65, 91, 13)	
SACCH/CTS	D&U	4, 5	C0 ... Cn	NB	104	B(65, 91, 13, 39)	
SACCH/CTS	D&U	6, 7	C0 ... Cn	NB	104	B(91, 13, 39, 65)	
SACCH/TH & SACCH/TPH	0	D&U <sup>2</sup>	0	C0 ... Cn	NB <sup>3</sup>	104	B(13, 39, 65, 91)
SACCH/TH & SACCH/TPH	1	D&U <sup>2</sup>	B(24, 50, 76, 102)	C0 ... Cn	NB <sup>3</sup>	104	B(13, 39, 65, 91)
SACCH/TH & SACCH/TPH	0	D&U <sup>2</sup>	1	C0 ... Cn	NB <sup>3</sup>	104	B(13, 39, 65, 91)
SACCH/TH & SACCH/TPH	1	D&U <sup>2</sup>	B(24, 50, 76, 102)	C0 ... Cn	NB <sup>3</sup>	104	B(39, 65, 91, 13)
SACCH/TH & SACCH/TPH	0	D&U <sup>2</sup>	2	C0 ... Cn	NB <sup>3</sup>	104	B(39, 65, 91, 13)
SACCH/TH & SACCH/TPH	1	D&U <sup>2</sup>	B(50, 76, 102, 24)	C0 ... Cn	NB <sup>3</sup>	104	B(39, 65, 91, 13)
SACCH/TH & SACCH/TPH	0	D&U <sup>2</sup>	3	C0 ... Cn	NB <sup>3</sup>	104	B(39, 65, 91, 13)
SACCH/TH & SACCH/TPH	1	D&U <sup>2</sup>	B(50, 76, 102, 24)	C0 ... Cn	NB <sup>3</sup>	104	B(65, 91, 13, 39)
SACCH/TH & SACCH/TPH	0	D&U <sup>2</sup>	4	C0 ... Cn	NB <sup>3</sup>	104	B(65, 91, 13, 39)
SACCH/TH & SACCH/TPH	1	D&U <sup>2</sup>	B(76, 102, 24, 50)	C0 ... Cn	NB <sup>3</sup>	104	B(65, 91, 13, 39)
SACCH/TH & SACCH/TPH	0	D&U <sup>2</sup>	5	C0 ... Cn	NB <sup>3</sup>	104	B(65, 91, 13, 39)
SACCH/TH & SACCH/TPH	1	D&U <sup>2</sup>	B(76, 102, 24, 50)	C0 ... Cn	NB <sup>3</sup>	104	B(91, 13, 39, 65)
SACCH/TH & SACCH/TPH	0	D&U <sup>2</sup>	6	C0 ... Cn	NB <sup>3</sup>	104	B(91, 13, 39, 65)
SACCH/TH & SACCH/TPH	1	D&U <sup>2</sup>	B(102, 24, 50, 76)	C0 ... Cn	NB <sup>3</sup>	104	B(91, 13, 39, 65)

SACCH/TH & SACCH/TPH	0 1	D&U <sup>2</sup>	7 B(102, 24, 50, 76)	C0 ... Cn	NB <sup>3</sup>	104	B(91, 13, 39, 65)
EPCCH/F	D&U <sup>2</sup>	0,2,4,6	C0 ... Cn	NB <sup>3</sup>	26	B0(13)	
EPCCH/F	D&U <sup>2</sup>	1,3,5,7	C0 ... Cn	NB <sup>3</sup>	26	B0(24)	
EPCCH/M	D&U <sup>2</sup>	0 ... 7	C0 ... Cn	NB <sup>3</sup>	26	B0(13)	
EPCCH/H	0 1	D&U <sup>2</sup>	0 ... 7 B0(24)	C0 ... Cn	NB <sup>3</sup>	26	B0(13)

NOTE 1: An Access Burst (AB) is used on the uplink during handover and on channels used for voice group calls when a request to talk is made.

NOTE 2: The uplink of a channel used for voice broadcast or a voice group call may actually not be used.

NOTE 3: An Access Burst (AB) may be used on the uplink during handover.

Table 2 : Mapping of logical channels onto physical channels (see subclauses 6.3, 6.4, 6.5)

Channel designation	Sub-channel number	Direction timeslot assignments	Allowable RF channel assignments	Allowable type TDMA frames	Burst length in mapping	Repeat	Interleaved block TDMA frame
TCH/F4.8 TCH/F9.6 TCH/F14.4	D&U	0 ... 7	C0 ... Cn	NB <sup>1</sup>	26	B0(0 ... 11, 13 ... 22)	
		B1(4 ... 11, 13 ... 24, 0, 1)					
		B2(8 ... 11, 13 ... 24, 0 ... 5)					
		B3(13 ... 24, 0 ... 9)					
		B4(17 ... 24, 0 ... 11, 13, 14)					
		B5(21 ... 24, 0 ... 11, 13 ... 18)					
E-TCH/F28.8 E-TCH/F32.0 E-TCH/F43.2	D&U	0 ... 7	C0 ... Cn	NB (8PSK)	26	B0(0 ... 11, 13 ... 22)	
		B1(4 ... 11, 13 ... 24, 0, 1)					
		B2(8 ... 11, 13 ... 24, 0 ... 5)					
		B3(13 ... 24, 0 ... 9)					
		B4(17 ... 24, 0 ... 11, 13, 14)					
		B5(21 ... 24, 0 ... 11, 13 ... 18)					
TCH/H2.4 TCH/H4.8	0	D&U	0 ... 7	C0 ... Cn	NB <sup>1</sup>	26	B0(0,2,4,6,8,10,13,15,17,19,21,
		23,0,2,4,6,8,10,13,15,17,19)					
		B1(8,10,13,15,17,19,21,23,0,2,4,					
		6,8,10,13,15,17,19,21,23,0,2),					
		B2(17,19,21,23,0,2,4,6,8,10,13,					
		15,17,19,21,23,0,2,4,6,8,10)					
	1		B0(1,3,5,7,9,11,14,16,18,20,22,				
		24,1,3,5,7,9,11,14,16,18,20),					
		B1(9,11,14,16,18,20,22,24,1,3,5,					
		7,9,11,14,16,18,20,22,24,1,3),					
		B2(18,20,22,24,1,3,5,7,9,11,14,					
		16,18,20,22,24,1,3,5,7,9,11)					

NOTE 1: An Access Burst (AB) is used on the uplink during handover.

Table 3 : Mapping of logical channels onto physical channels (see subclauses 6.3, 6.4, 6.5)

Channel designation	Sub-channel number	Direction timeslot assignments	Allowable RF channel assignments	Allowable type TDMA frames	Burst length in mapping	Repeat TDMA frame	Interleaved block
FCCH	D	0	C0	FB	51B0(0),B1(10),B2(20),B3(30),B4(40)		
SCH	D	0	C0	SB	51B0(1),B1(11),B2(21),B3(31),B4(41)		
BCCH Norm	D	0,2,4,6	C0	NB	51	B(2..5)	
BCCH Ext	D	0,2,4,6	C0	NB	51	B(6..9)	
PCH AGCH	D	0,2,4,6 B3(22..25),B4(26..29),B5(32..35), B6(36..39),B7(42..45),B8(46..49)	C0	NB	51B0(6..9),B1(12..15),B2(16..19)		
NCH	D	0 B3(22..25),B4(26..29),B5(32..35), B6(36..39)	C0	NB	51B0(6..9),B1(12..15),B2(16..19)		
RACH	U	0,2,4,6	C0	AB, Extended AB <sup>2</sup>	51	B0(0),B1(1)..B50(50)	
CBCH(SDCCH/4)	D	0	C0	NB	51	B(32..35)	
CBCH(SDCCH/8)	D	0 ... 3	C0 ... Cn	NB	51	B(8..11)	
SDCCH/4	0	D	0	C0	NB <sup>1</sup>	51	B(22..25)
	U		B(37..40)				
	1	D		B(26..29)			
	U		B(41..44)				
	2	D		B(32..35)			
U		B(47..50)		B(36..39)			
3	D		B(0..3)				
U							
SACCH/C4	0	D	0	C0	NB <sup>3</sup>	102	B(42..45)
	U		B(57..60)				
	1	D		B(46..49)			
	U		B(61..64)				
	2	D		B(93..96)			
U		B(6..9)		B(97..100)			
3	D		B(10..13)				
U							

NOTE 1: An Access Burst (AB) is used on the uplink during handover.

NOTE 2: For Multilateration Timing Advance using the Extended Access Burst method, the Extended AB format is used.

NOTE 3: An Access Burst (AB) may be used on the uplink during handover.

Table 4 : Mapping of logical channels onto physical channels (see subclauses 6.3, 6.4, 6.5)

Channel designation	Sub-channel number	Direction timeslot assignments	Allowable RF channel assignments	Allowable type TDMA frames	Burst length in mapping	Repeat	Interleaved block TDMA frame
SDCCH/8	0	D	0 ... 7	C0 ... Cn	NB <sup>1</sup>	51	B (0 ... 3)
	U		B (15 ... 18)				
	1	D		B (4 ... 7)			
	U		B (19 ... 22)				
	2	D		B (8 ... 11)			
	U		B (23 ... 26)				
	3	D		B (12 ... 15)			
	U		B (27 ... 30)				
SACCH/C8	4	D		B (16 ... 19)	NB <sup>3</sup>	102	B (32 ... 35)
	U		B (31 ... 34)				
	5	D		B (20 ... 23)			
	U		B (35 ... 38)				
	6	D		B (24 ... 27)			
	U		B (39 ... 42)				
	7	D		B (28 ... 31)			
	U		B (43 ... 46)				
SACCH/C8	0	D	0 ... 7	C0 ... Cn	NB <sup>3</sup>	102	B (32 ... 35)
	U		B (47 ... 50)				
	1	D		B (36 ... 39)			
	U		B (51 ... 54)				
	2	D		B (40 ... 43)			
	U		B (55 ... 58)				
	3	D		B (44 ... 47)			
	U		B (59 ... 62)				
SACCH/C8	4	D		B (83 ... 86)	NB <sup>3</sup>	102	B (32 ... 35)
	U		B (98 ... 101)				
	5	D		B (87 ... 90)			
	U		B (0 ... 3)				
	6	D		B (91 ... 94)			
	U		B (4 ... 7)				
	7	D		B (95 ... 98)			
	U		B (8 ... 11)				

NOTE 1: An Access Burst (AB) is used on the uplink during handover.

NOTE 3: An Access Burst (AB) may be used on the uplink during handover.

**Table 5 : Mapping of logical channels onto physical channels (see subclauses 6.3, 6.4, 6.5)**

BS_CCCH_SDCCH_COMB		Access grant blocks available (NOTE: Some access grant blocks may also be used for the NCH)		BS_AG_BLK_RES		Paging channel blocks available (Paging block index = 0, 1, 2, 3, 4, 5, 6, 7, 8)	
Random access channel blocks available				Number of paging blocks available per 51-multiframe			
False	B0, B1 ... B50	B0, B1 ... B8	0	9	B0, B1, B2, B3, B4, B5, B6, B7, B8		
False	1	8			B1, B2, B3, B4, B5, B6, B7, B8		
False	2	7			B2, B3, B4, B5, B6, B7, B8		
False	3	6			B3, B4, B5, B6, B7, B8		
False	4	5			B4, B5, B6, B7, B8		
False	5	4			B5, B6, B7, B8		
False	6	3			B6, B7, B8		
False	7	2			B7, B8		
True	B4, B5, B14, B15 ... B36, B45, B46	B0, B1, B2	0	3	B0, B1, B2		
True	1	2			B1, B2		
True	2	1			B2		

**Table 6 : Mapping of logical channels onto physical channels (see subclauses 6.3, 6.4, 6.5) -**



Channel designation	Sub-channel number	Direction	Allowable time-slot assignment	Allowable RF channel assignment	Burst type	Repeat length in TDMA frames	Interleaved block TDMA frame mapping
PDTCH/F, PACCH/F		D&U	0...7	C0...Cn	NB1	52	<p>BTTI configuration: B0(0...3), B1(4...7), B2(8...11), B3(13...16), B4(17...20), B5(21...24), B6(26...29), B7(30...33), B8(34...37), B9(39...42), B10(43...46), B11(47...50)</p> <p>RTTI configuration: B0<sub>a</sub>(0,0',1,1'), B0<sub>b</sub>(2,2',3,3'), B1<sub>a</sub>(4,4',5,5'), B1<sub>b</sub>(6,6',7,7'), B2<sub>a</sub>(8,8',9,9'), B2<sub>b</sub>(10,10',11,11'), B3<sub>a</sub>(13,13',14,14'), B3<sub>b</sub>(15,15',16,16'), B4<sub>a</sub>(17,17',18,18'), B4<sub>b</sub>(19,19',20,20'), B5<sub>a</sub>(21,21',22,22'), B5<sub>b</sub>(23,23',24,24'), B6<sub>a</sub>(26,26',27,27'), B6<sub>b</sub>(28,28',29,29'), B7<sub>a</sub>(30,30',31,31'), B7<sub>b</sub>(32,32',33,33'), B8<sub>a</sub>(34,34',35,35'), B8<sub>b</sub>(36,36',37,37'), B9<sub>a</sub>(39,39',40,40'), B9<sub>b</sub>(41,41',42,42'), B10<sub>a</sub>(43,43',44,44'), B10<sub>b</sub>(45,45',46,46'), B11<sub>a</sub>(47,47',48,48'), B11<sub>b</sub>(49,49',50,50')</p> <p>Note : In RTTI configuration, a PDTCH is mapped onto two PDCHs, a PDCH-pair. Number n indicates mapping on the PDCH with the lowest timeslot number in TDMA frame n, whereas number n' indicates mapping on the PDCH with the highest timeslot number in TDMA frame n.</p>
PDTCH/H, PACCH/H	0	D&U	0...7	C0... Cn	NB1	52	B0(0,2,4,6), B1(8,10,13,15), B2(17,19,21,23), B3(26,28,30,32), B4(34,36,39,41), B5(43,45,47,49)
	1	D&U	0...7	C0...Cn	NB1	52	B0(1,3,5,7), B1(9,11,14,16), B2(18,20,22,24), B3(27,29,31,33), B4(35,37,40,42), B5(44,46,48,50)
PBCCH		D	0...7	C0...Cn	NB	52	B0(0... 3), B3(13...16), B6(26...29), B9(39...42)
PRACH		U	0...7	C0...Cn	AB	52	B0(0)...B11(11), B12(13)...B23(24), B24(26)... B35(37), B36(39)...B47(50)
MPRACH		U	0...7	C0...Cn	AB	52	B0(0)...B11(11), B12(13)...B23(24), B24(26)... B35(37), B36(39)...B47(50)
PPCH		D	0...7	C0...Cn	NB	52	B1(4 ... 7), B2(8...11), B3(13...16), B4(17...20), B5(21...24), B6(26...29), B7(30...33), B8(34...37), B9(39...42), B10(43...46), B11(47...50)
PAGCH		D	0...7	C0...Cn	NB	52	B0(0...3), B1(4 ... 7), B2(8...11), B3(13...16), B4(17...20), B5(21...24), B6(26...29), B7(30...33), B8(34...37), B9(39...42), B10(43...46), B11(47...50)
PTCCH/D		D	0...7	C0...Cn	NB	416	B0(12,38,64,90), B1(116,142,168,194), B2(220,246,272,298), B3(324,350,376,402)

PTCCH/U	0	U	0...7	C0...Cn	AB	416	B0(12)
	1						B0(38)
	2						B0(64)
	3						B0(90)
	4						B0(116)
	5						B0(142)
	6						B0(168)
	7						B0(194)
	8						B0(220)
	9						B0(246)
	10						B0(272)
	11						B0(298)
	12						B0(324)
	13						B0(350)
	14						B0(376)
	15						B0(402)

NOTE 1: An Access Burst (AB) may be used on the uplink as polling response.

Table 6a : Mapping of Extended Coverage logical channels onto physical channels (see subclauses 6.3, 6.4, 6.5)

Channel designation	Dir.	Allowable timeslot assignment	Allowable RF channel assignment	Burst type	Repeat length TDMA frames	Coverage class (CC)	Interleaved block TDMA frame mapping			
EC-SCH	D	1	C0	SB	204	-	$B([0,1,2,3,4,5,6] + 51N)$ , $N=0,1,2,3^4$			
EC-BCCH	D	1	C0	NB	408	-	$B([7,8,9,10,11,12,13,14]+51N)$ , $N=0,\dots,7^5$			
EC-PCH	D	1,3,5,7	C0	NB	51	1	$B0(19,20),B1(21,22),\dots,B15(49,50)$			
					102	2	$B0([19,\dots,26] + 51N),B1([27,\dots,34] + 51N),\dots,B3([43,\dots,50] + 51N)$ , $N=0,1^3$			
					102	3	$B0([19,\dots,34] + 51N)$ , $B1([35,\dots,50] + 51N)$ , $N=0,1^3$			
					204	4	$B0([19,\dots,34] + 51N)$ , $B1([35,\dots,50] + 51N)$ , $N=0,1,2,3^4$			
EC-AGCH	D	1	C0	NB	51	1	$B0(15,16),B1(17,18),\dots,B17(49,50)^{14}$			
					102	2	$B0([19,\dots,26] + 51N),B1([27,\dots,34] + 51N),\dots,B3([43,\dots,50] + 51N)$ , $N=0,1^3$			
					102	3	$B0([19,\dots,34] + 51N)$ , $B1([35,\dots,50] + 51N)$ , $N=0,1^3$			
					204	4	$B0([19,\dots,34] + 51N)$ , $B1([35,\dots,50] + 51N)$ , $N=0,1,2,3^4$			
			3,5,7			51	1	$B0(1,2),B1(3,4),\dots,B24(49,50)^{15}$		
						102	2	$B0([3,\dots,10] + 51N),B1([11,\dots,18] + 51N),\dots,B5([43,\dots,50] + 51N)$ , $N=0,1^3$		
						102	3	$B0([3,\dots,18] + 51N)$ , $B1([19,\dots,34] + 51N)$ , $B2([35,\dots,50] + 51N)$ , $N=0,1^3$		
						204	4	$B0([3,\dots,18] + 51N)$ , $B1([19,\dots,34] + 51N)$ , $B2([35,\dots,50] + 51N)$ , $N=0,1,2,3^4$		
EC-RACH, 1 TS	U	1,3,5,7	C0	AB, Extended AB <sup>7</sup>	51	1	$B0(0),B1(1),\dots,B50(50)$			
						2	$B0(1,\dots,4)$ , $B1(5,\dots,8),\dots,B11(45,\dots,48)$			
						3	$B0(2,\dots,17),B1(18,\dots,33)$ , $B2(34,\dots,49)$			
						4	$B0([0,\dots,23] + 51N),B1([24,\dots,47] + 51N)$ , $N=0,1^3$			
EC-RACH, 2 TS	U	0,1, or, 2,3, or, 4,5, or, 6,7	C0	AB	51	2	$B0(1,2,1',2')$ , $B1(3,4,3',4')$ , $\dots,B24(49,50,49',50')$			
						3	$B0(2,\dots,9,2',\dots,9')$ , $B1(10,\dots,17,10',\dots,17')$ , $\dots,B5(42,\dots,49,42',\dots,49')$			
							EDAB, ESAB	153	5	$B0([0,\dots,11,0',\dots,11'] + 51N),\dots,B3([36,\dots,47,36',\dots,47'] + 51N)$ , $N=0,1^3$
										$B0([0,\dots,21,0',\dots,21'] + 51N)$ , $B1([22,\dots,43,22',\dots,43'] + 51N)$ , $N=0,1,2^8$
EC-PACCH, EC-PDTCH	D&U	0...7	C0...Cn	NB <sup>2</sup>	52	1	$B0(0\dots3)$ , $B1(4\dots7)$ , $B2(8\dots11)$ , $B3(13\dots16)$ , $B4(17\dots20)$ , $B5(21\dots24)$ , $B6(26\dots29)$ , $B7(30\dots33)$ , $B8(34\dots37)$ , $B9(39\dots42)$ , $B10(43\dots46)$ , $B11(47\dots50)$			
						2	$B0(0\dots3,0'\dots3',0''\dots3'')$ , $B1(4\dots7,4'\dots7',4''\dots7'')$ , $B2(8\dots11,8'\dots11',8''\dots11'')$ , $B3(13\dots16,13'\dots16',13''\dots16'')$ , $B4(17\dots20,17'\dots20',17''\dots20'')$ , $B5(21\dots24,21'\dots24',21''\dots24'')$ , $B6(26\dots29,26'\dots29',26''\dots29'')$ , $B7(30\dots33,30'\dots33',30''\dots33'')$ , $B8(34\dots37,34'\dots37',34''\dots37'')$ , $B9(39\dots42,39'\dots42',39''\dots42'')$ , $B10(43\dots46,43'\dots46',43''\dots46'')$ , $B11(47\dots50,47'\dots50',47''\dots50'')$ <sup>1</sup>			
						3	$B0(0\dots7,0'\dots7',0''\dots7'')$ , $B1(8\dots11,13\dots16,8'\dots11',13'\dots16',8''\dots11'',13''\dots16'')$ , $B2(17\dots24,17'\dots24',17''\dots24'')$ , $B3(26\dots33,26'\dots33',26''\dots33'')$ , $B4(34\dots37,39\dots42,34'\dots37',39'\dots42',34''\dots37'',39''\dots42'')$ , $B5(43\dots50,43'\dots50',43''\dots50'')$ <sup>1</sup>			
						4	$B0(0\dots11,13\dots16,0'\dots11',13'\dots16',0''\dots11'',13''\dots16'')$ , $B1(17\dots24,26\dots33,17'\dots24',26'\dots33',17''\dots24'',26''\dots33'')$ , $B2(34\dots37,39\dots50,34'\dots37',39'\dots50',34''\dots37'',39''\dots50'')$ <sup>1</sup>			

	U				52	5	B0(0..11,13..24,26..37,39..50,0'..11',13'..24',26'..37',39'..50', 0'..11'',13''..24'',26''..37'',39''..50'',0''..11'',13''..24'',26''..37'',39''..50'')
	D&U				52	2 <sup>6</sup>	B0(0..7,0'..7'), B1(8..11,13..16,8'..11',13'..16'), B2(17..24,17'..24'), B3(26..33,26'..33'), B4(34..37,39..42,34'..37',39'..42'), B5(43..50,43'..50')
	D&U				52	3 <sup>6</sup>	B0(0..11,13..16,0'..11',13'..16), B1(17..24,26..33, 17'..24',26'..33'), B2(34..37,39..50,34'..37',39'..50')
	D&U				104	4 <sup>6</sup>	B0(0..11,13..24,26..33,0'..11',13'..24',26'..33'), B1(34..37,39..50,52..63,34'..37',39'..50',52'..63'), B2(65..76,78..90,92..103,65'..76',78'..90',92'..103')
	U				104	5 <sup>6</sup>	B0([0..11,13..24,26..37,39..50,0'..11',13'..24',26'..37',39'..50'] + 52N), N=0,1 <sup>9</sup>
EC-PICH	D	1	C0	NB	102	3	B0([17,18]+51N), N=1 <sup>10</sup>
	D	1	C0	NB	204	4	B0(15,16), B1(17,18) <sup>11</sup>
		3,5,7	C0	NB	102	3	B0([1,2]+51N), N=1 <sup>12</sup>
		3,5,7	C0	NB	204	4	B0(1,2),B1([1,2]+51N), N=2 <sup>13</sup>

NOTE 1: EC-PDCH and EC-PACCH are mapped onto four PDCHs. Number n indicates mapping on the PDCH with the lowest timeslot number in TDMA frame n, whereas number n', n'', and n''' indicates mapping on the PDCH with the second lowest, second highest, and highest timeslot number in TDMA frame n respectively. The four timeslots shall be consecutive.

NOTE 2: Access Bursts (AB) instead of Normal Bursts (NB) may be used on the uplink as polling response on EC-PACCH/U. The same resources are used by the Access Burst.

NOTE 3:  $N = (FN \text{ div } 51) \text{ mod } 2$

NOTE 4:  $N = (FN \text{ div } 51) \text{ mod } 4$

NOTE 5:  $N = (FN \text{ div } 51) \text{ mod } 8$

NOTE 6: EC-PDCH/2TS and EC-PACCH/2TS are mapped onto two PDCHs in case of blind physical layer transmissions.

NOTE 7: For Multilateration Timing Advance using the Extended Access Burst method in EC operation, the Extended AB format is used in case of CC1 selected in downlink and uplink.

NOTE 8:  $N = (FN \text{ div } 51) \text{ mod } 3$

NOTE 9: Transmission for EC-PDCH and EC-PACCH using 2 PDCHs is distributed over  $2 * 52$ -multiframes.

NOTE 10: One EC-PICH block occurs in every  $2*51$  multiframes indicating the paging for both paging blocks in next  $2*51$ -multiframes.

NOTE 11: Two EC-PICH blocks occur in every  $4*51$ -multiframes, with B0 indicating the paging for paging block 0 in the  $4*51$ -multiframe and B1 indicates the paging for paging block 1 in the  $4*51$  multiframe.

NOTE 12: The first EC-PICH block B0 indicates the paging for paging block 1 in the same  $4*51$ -multiframe. The second EC-PICH block B1 indicates the paging for paging block 0 in the next  $4*51$ -multiframes.

NOTE 13: Two EC-PICH blocks occur in every  $4*51$  multiframes, with B0 indicates the paging for first paging block in the  $4*51$ -multiframe and B1 indicates the paging for second paging block in the  $4*51$ -multiframe.

NOTE 14: If EC-PICH channel for TN1 is configured, in some 51 multiframes one or more EC-AGCH blocks are replaced by EC-PICH blocks. The EC-AGCH blocks applicable when EC-PICH is configured is illustrated in Figure 22.

NOTE 15: If EC-PICH channel is configured in one or more of the timeslots of TN3, TN5, TN7, the first EC-AGCH block (B0) is replaced by EC-PICH block in the 51-multiframe corresponds to the respective timeslot. The EC-AGCH block mapping when EC-PICH is configured for TN3, TN5 and TN7 is illustrated in Figure 23.

**Table 7 : Mapping of logical channels onto physical channels (see subclauses 6.3, 6.4, 6.5)****Non-COMPACT :**

BS_PAG_BLK_RES + BS_PBCCH_BLK		
Number of paging blocks available per 52-multiframe		
Paging channel blocks available for 52-multiframe (Paging block index = 0, 1, 2, 3, 4, 5, 6, 7, 8, 9, 10)		
1	11	B1, B2, B3, B4, B5, B6, B7, B8, B9, B10, B11
2	10	B1, B2, B3, B4, B5, B7, B8, B9, B10, B11
3	9	B1, B2, B4, B5, B7, B8, B9, B10, B11
4	8	B1, B2, B4, B5, B7, B8, B10, B11
5	7	B2, B4, B5, B7, B8, B10, B11
6	6	B2, B4, B5, B8, B10, B11
7	5	B2, B5, B8, B10, B11
8	4	B2, B5, B8, B11
9	3	B5, B8, B11
10	2	B5, B11
11	1	B11

Table 7a : Mapping of logical channels onto physical channels (see subclauses 6.3, 6.4, 6.5)

## COMPACT :

	BS_PBCCH_BLKs = 1	BS_PBCCH_BLKs = 2
BS_PAG_BLKs_RES	Paging channel blocks available for 52-multiframe (Paging block index = 0, 1, 2, 3, 4, 5, 6, 7, 8, 9, 10)	Paging channel blocks available for 52-multiframe (Paging block index = 0, 1, 2, 3, 4, 5, 6, 7, 8, 9, 10)
0	B1, B2, B3, B4, B5, B6, B7, B8, B9, B10, B11	B1, B2, B3, B4, B5, B7, B8, B9, B10, B11
1	B1, B2, B3, B4, B5, B6, B7, B8, B9, B10	B1, B2, B3, B4, B5, B7, B8, B9, B10
2	B1, B2, B3, B4, B6, B7, B8, B9, B10	B1, B2, B3, B4, B7, B8, B9, B10
3	B1, B2, B3, B4, B6, B7, B9, B10	B1, B2, B3, B4, B7, B9, B10
4	B1, B3, B4, B6, B7, B9, B10	B1, B3, B4, B7, B9, B10
5	B1, B3, B4, B6, B7, B9	B1, B3, B4, B7, B9
6	B1, B3, B6, B7, B9	B1, B3, B7, B9
7	B1, B3, B6, B9	B1, B3, B9
8	B3, B6, B9	B3, B9

	BS_PBCCH_BLKs = 3	BS_PBCCH_BLKs = 4
BS_PAG_BLKs_RES	Paging channel blocks available for 52-multiframe (Paging block index = 0, 1, 2, 3, 4, 5, 6, 7, 8, 9, 10)	Paging channel blocks available for 52-multiframe (Paging block index = 0, 1, 2, 3, 4, 5, 6, 7, 8, 9, 10)
0	B1, B2, B4, B5, B7, B8, B9, B10, B11	B1, B2, B4, B5, B7, B8, B10, B11
1	B1, B2, B4, B5, B7, B8, B9, B10	B1, B2, B4, B5, B7, B8, B10
2	B1, B2, B4, B7, B8, B9, B10	B1, B2, B4, B7, B8, B10
3	B1, B2, B4, B7, B9, B10	B1, B2, B4, B7, B10
4	B1, B4, B7, B9, B10	B1, B4, B7, B10
5	B1, B4, B7, B9	B1, B4, B7
6	B1, B7, B9	B1, B7
7	B1, B9	-
8	-	-

NOTE: In COMPACT, BS\_PAG\_BLKs\_RES shall be less than or equal to 8 and less than or equal to 10 BS\_PBCCH\_BLKs.

**Table 8 : Mapping of logical channels onto physical channels (see subclauses 6.3, 6.4, 6.5)**

Channel designation	Sub-channel number	Direction	Allowable time-slot assignment	Allowable RF channel assignment	Burst type	Repeat length in TDMA frames	Interleaved block TDMA frame mapping
CTSBCH-FB		D	0...7	C0	FB	52	B(25)
CTSBCH-SB		D	0...7	C0	SB	52	B(51)
CTSPCH		D	0...7	C0...Cn	NB	52	B(2...5)
CTSARCH		U	0...7	C0 C0...Cn	SB	52	B0(2)...B7(9) B8(10)...B13(15)
CTSAGCH		D	0...7	C0 C0...Cn	NB	52	B0(16..19) B1(20..23)

NOTE 1: In CTS, C0 shall be interpreted as CTSBCH RF channel and C0...Cn as the RF channels of the TFH carrier list (refer to 3GPP TS 45.056).

NOTE 2: For the precise specification of the timeslot assignment, refer to subclause 6.3.3.1 and 6.3.3.2.

**Table 9 : Mapping of COMPACT logical channels onto physical channels (see subclauses 6.3, 6.4, and 6.5)**

Channel Designation	Sub-Channel Number	Direction	Allowable Timeslot Alignment	Allowable RF Channel Assignment	Burst Type	Repeat Length in TDMA Frames	Interleaved Block TDMA Frame Mapping
CFCCH		D	1, 3, 5, 7	C0 ... Cn	FB	52	B0 (25)
CSCH		D	1, 3, 5, 7	C0 ... Cn	SB	52	B0 (51)
CPBCCH		D	1, 3, 5, 7	C0 ... Cn	NB	52	B0 (0 ... 3), B6 (26 ... 29), B3 (13 ... 16), B9 (39 ... 42)
CPRACH		U	1, 3, 5, 7	C0 ... Cn	AB	52	B0 (0) ... B11 (11), B12 (13) ... B23 (24), B24 (26) ... B35 (37), B36 (39) ... B47 (50)
CPAGCH, CPPCH		D	1, 3, 5, 7	C0 ... Cn	NB	52	B1 (4 ... 7), B2 (8 ... 11), B3 (13 ... 16), B4 (17 ... 20), B5 (21 ... 24), B6 (26 ... 29), B7 (30 ... 33), B8 (34 ... 37), B9 (39 ... 42), B10 (43 ... 46), B11 (47 ... 50)

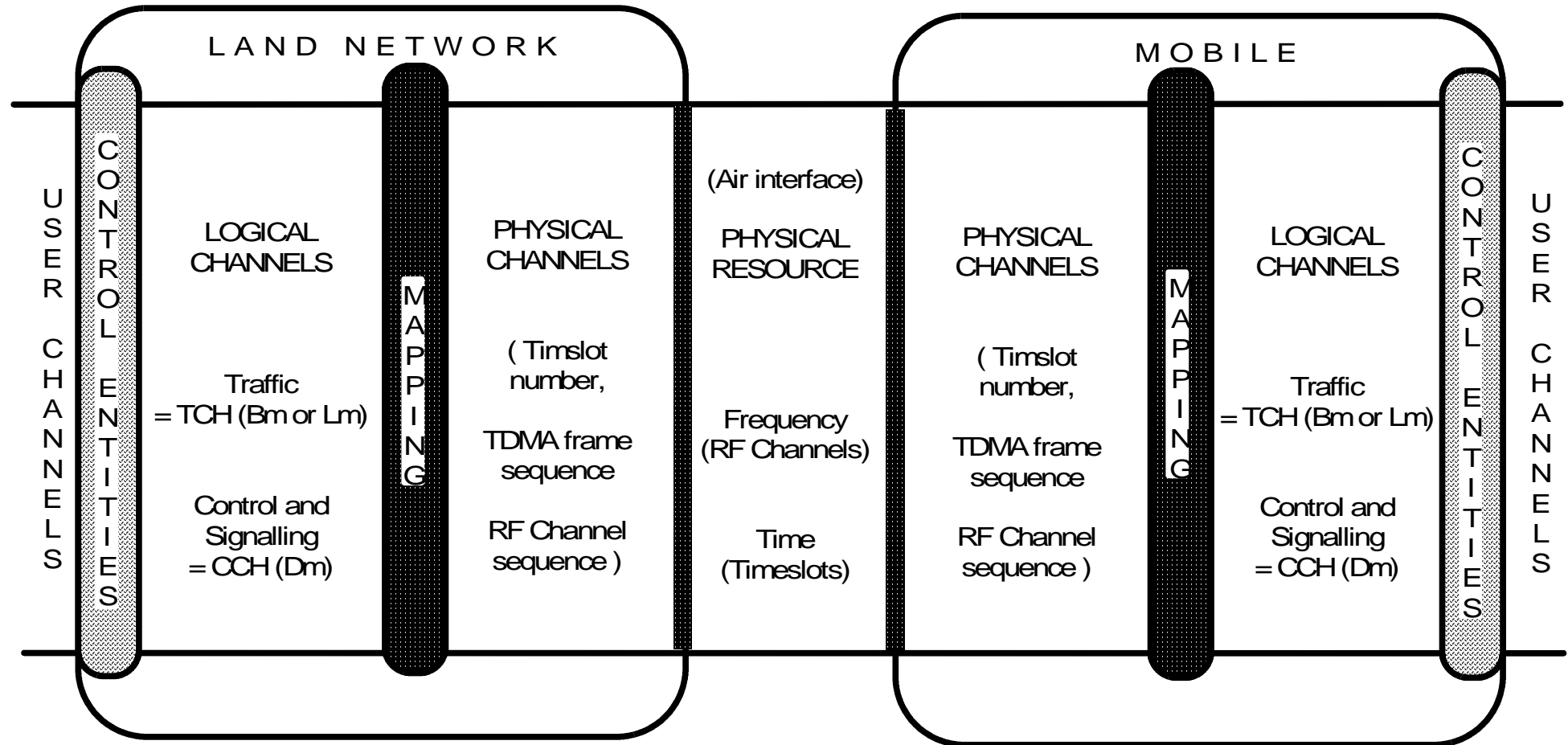

Figure 1: Mapping of logical channels onto physical channels based on the physical resource



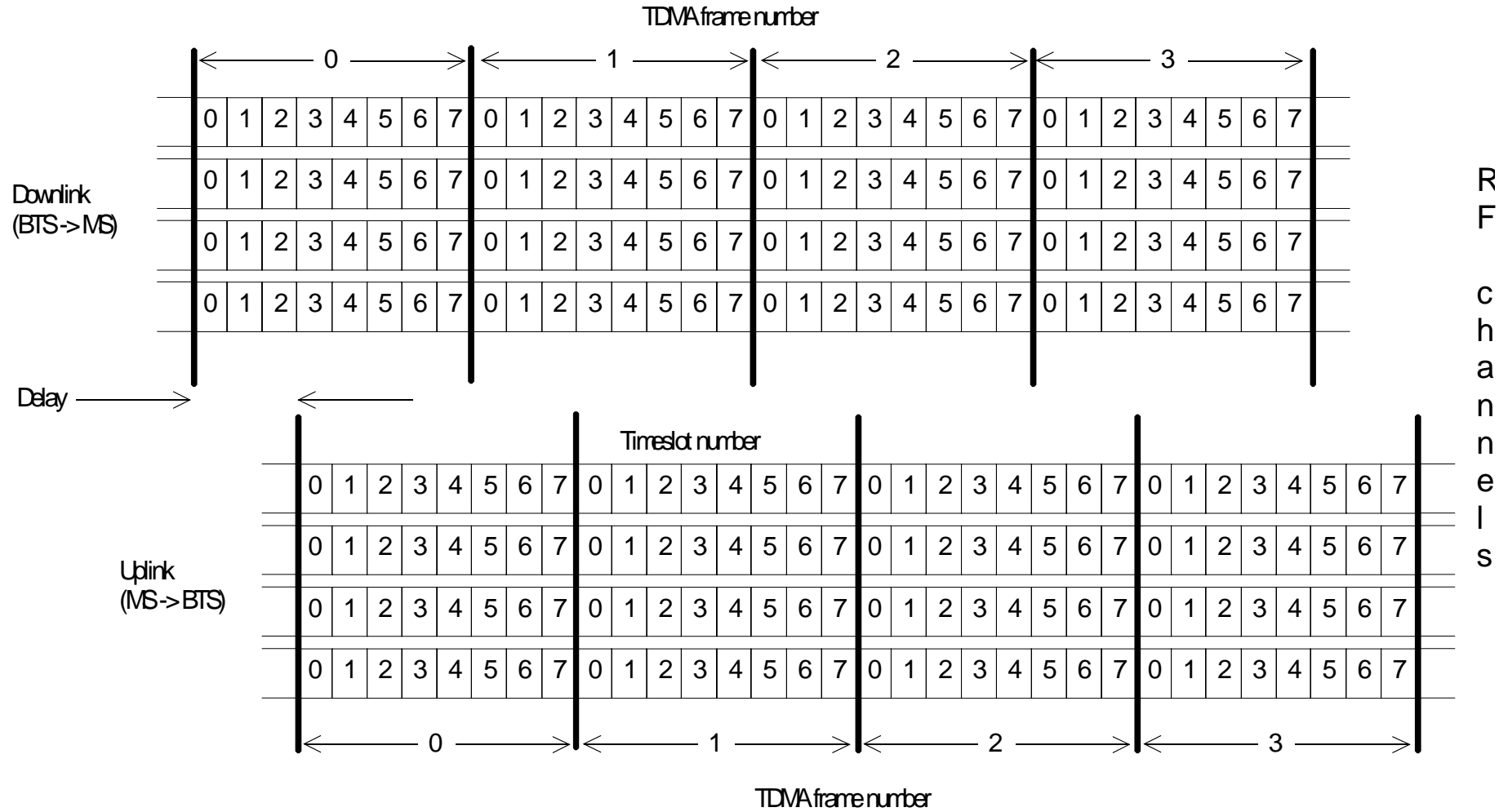

Figure 2: The structure imposed on the physical resource: Timeslots, TDMA Frames and Radio Frequency channels (in this example the cell has an allocation of 4 RF Channels pairs)

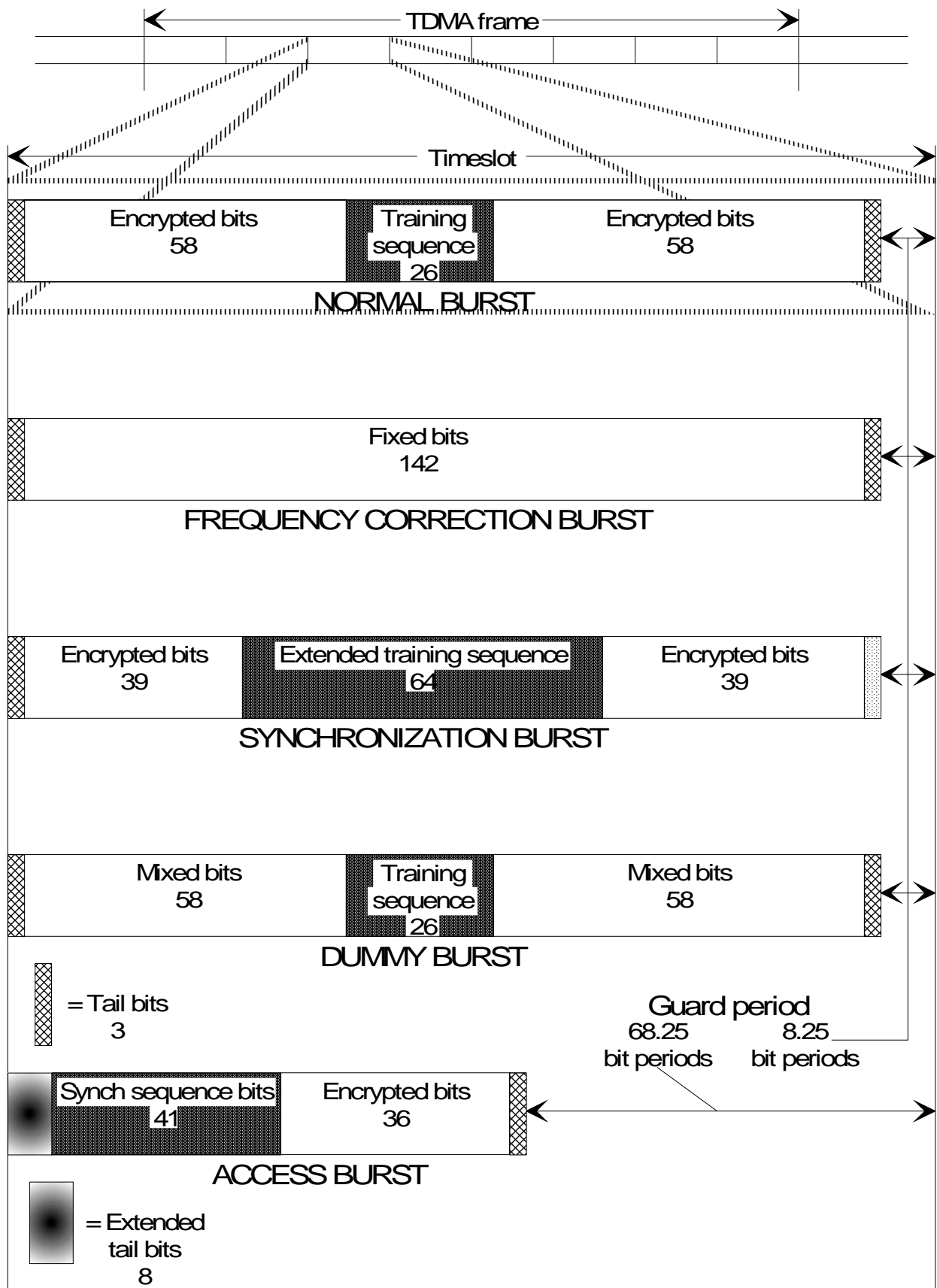
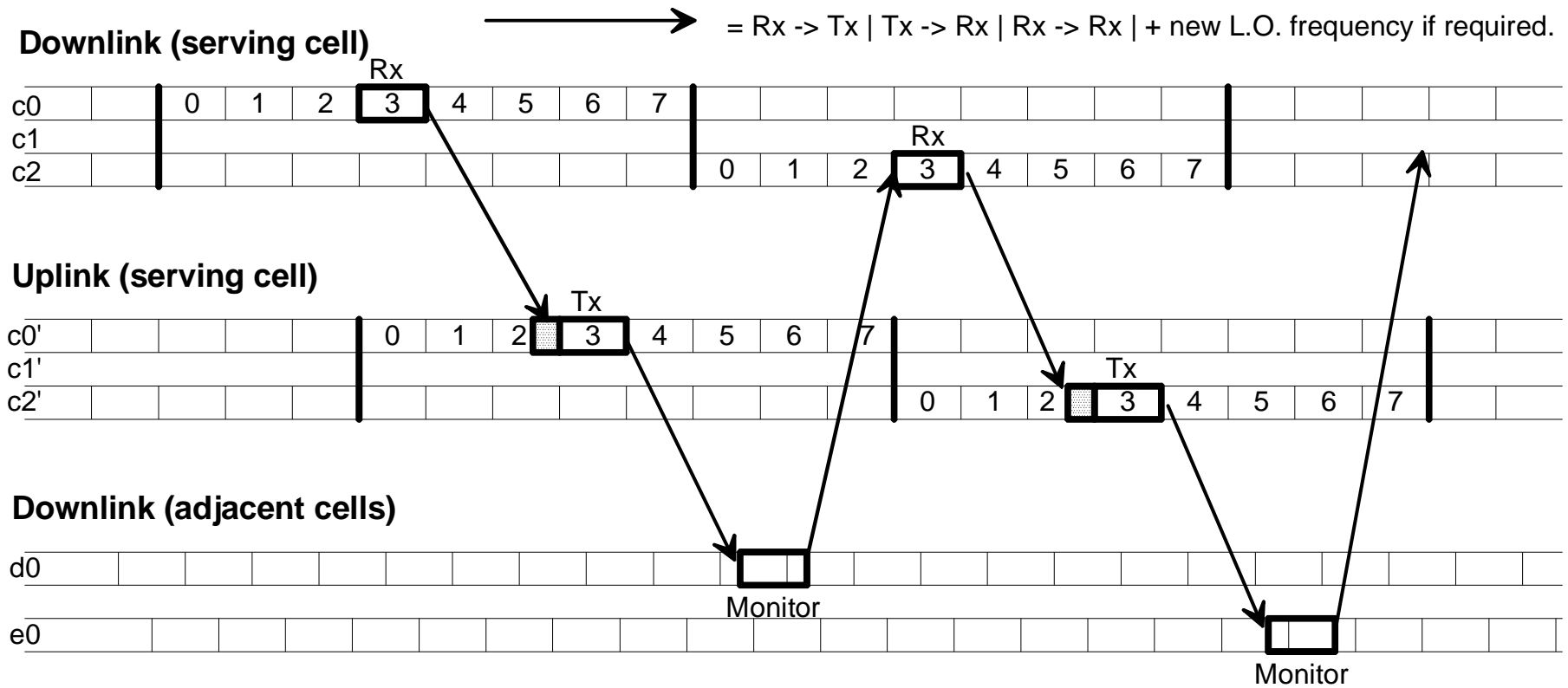
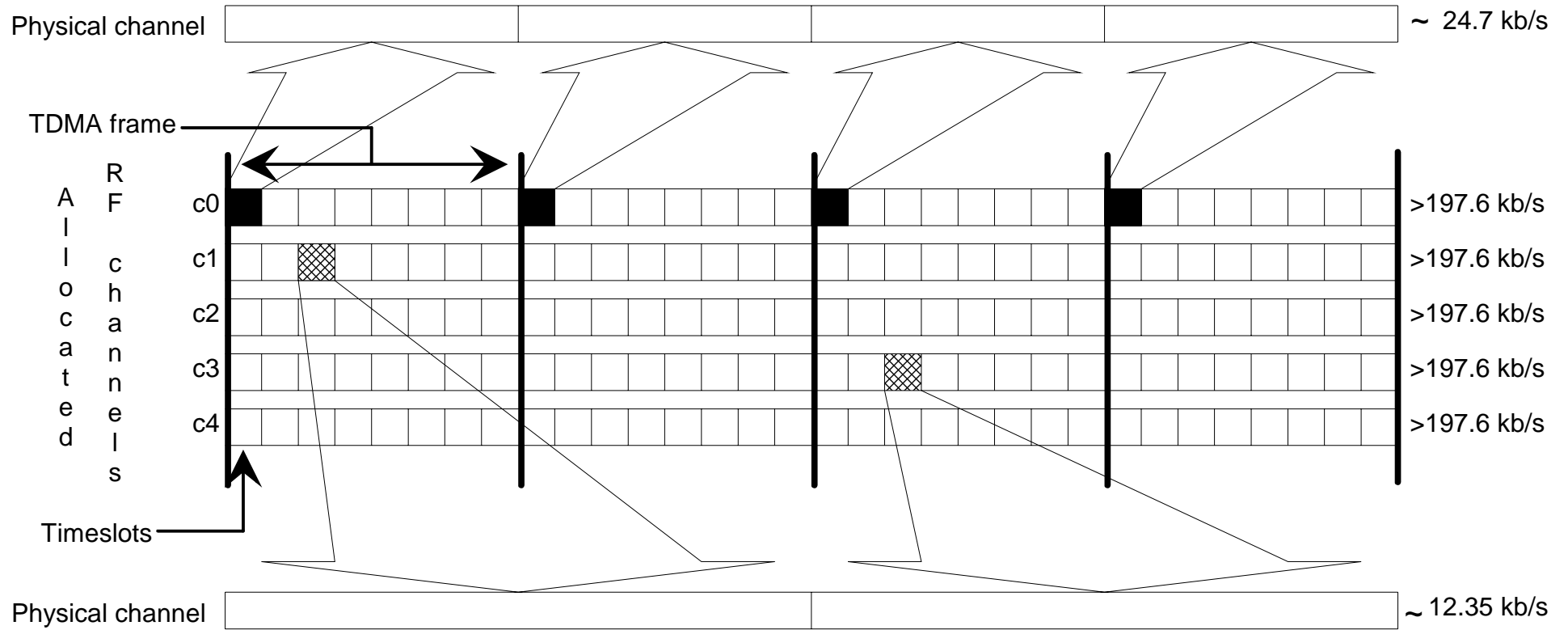

Figure 3: Timeslot and format of bursts



(This example of a physical channel is non-hopping using timeslot 0 of every TDMA frame)

**Figure 4: Mobile Station usage of physical channel timeslots (For a full-rate hopping traffic channel assigned timeslot 3)**



(This example of a physical channel is hopping using 3 of every other TDMA frame)

Figure 5: Example of two different physical channels

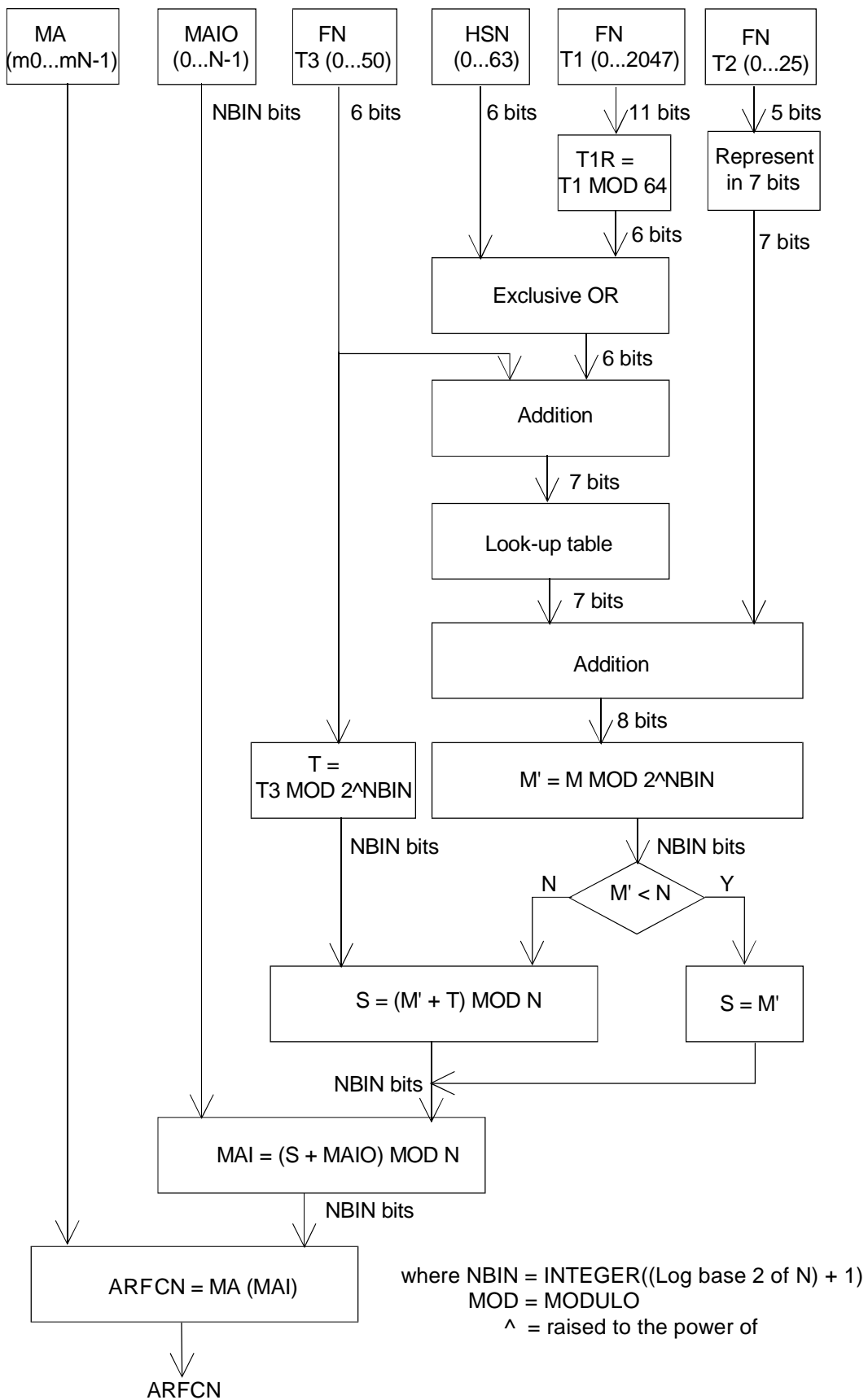
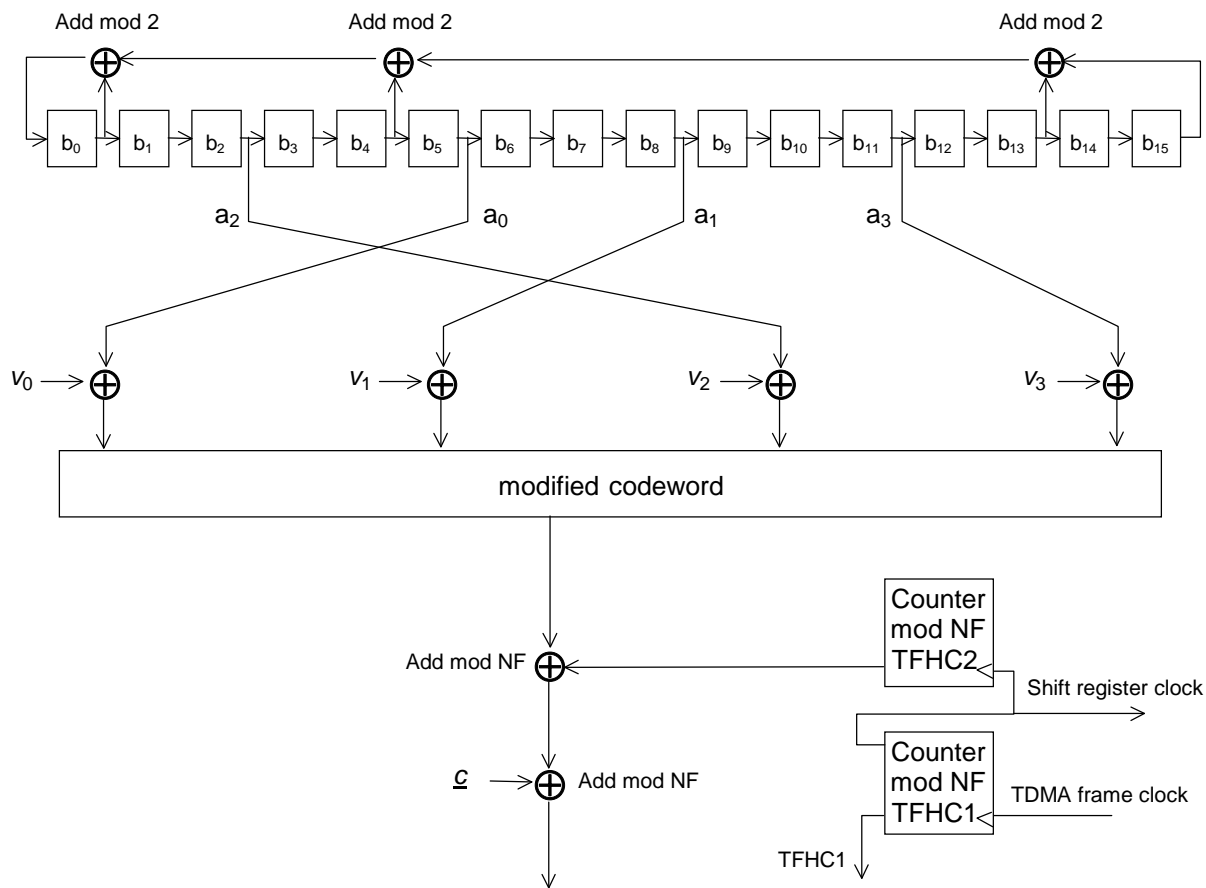

Figure 6: Block diagram of the frequency hopping algorithm when HSN ≠ 0



**Figure 6a: General structure of hopping sequence generation for CTS**

NOTE: Example with vector  $\underline{a} = (a_0, a_1, a_2, a_3) = (5, 8, 2, 11)$ .



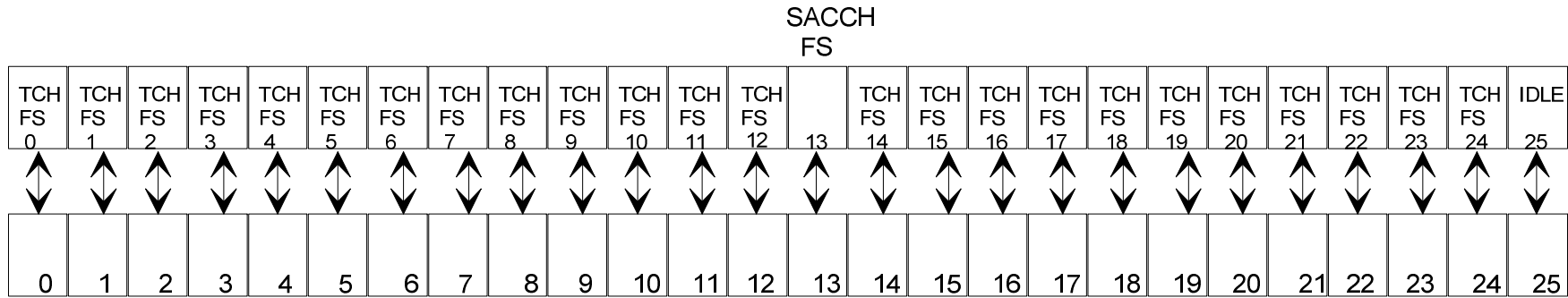

Figure 7c: TDMA frame mapping for TCH/FS + SACCH/FS for VAMOS II and VAMOS III MS when assigned a training sequence in TSC Set 2 or Set 4

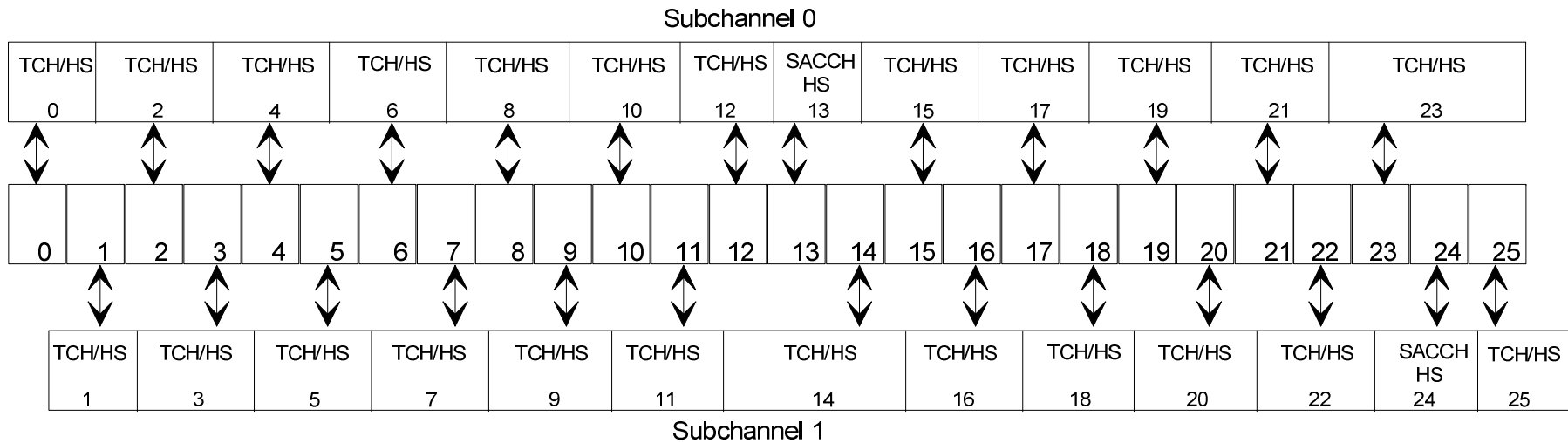

Figure 7d: TDMA frame mapping for TCH/HS + SACCH/HS sub-channels 0 and 1 for VAMOS II and VAMOS III MS when assigned a training sequence in TSC Set 2 or Set 4

Figure 7: Example of a TDMA frame mapping for traffic channels







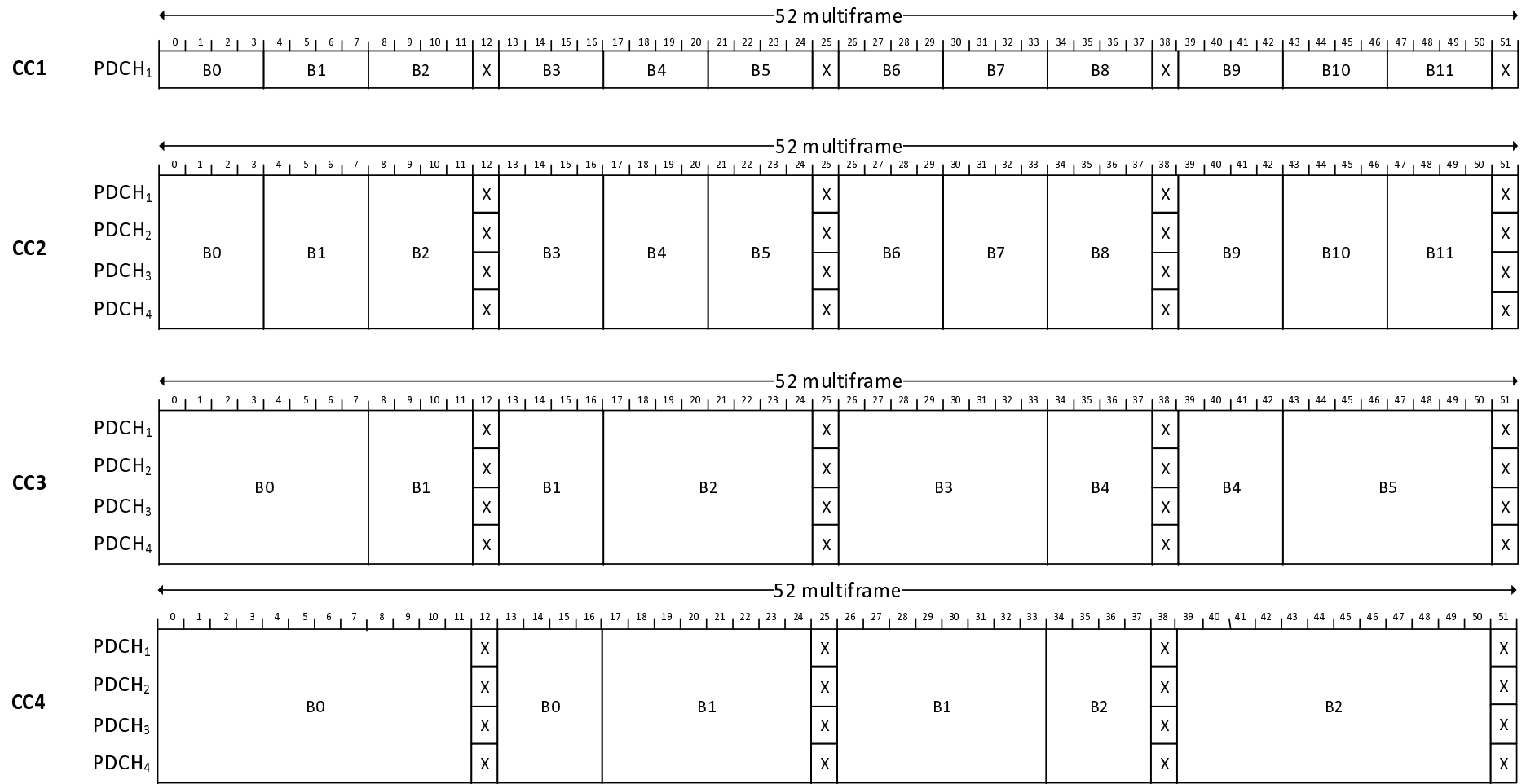

X = Idle frame  
 BY = Block Y

Figure 9b: 52-multiframe for EC-GSM-IoT for different Coverage Classes (CC) using 4 PDCHs for CC2 to CC4 in EC operation

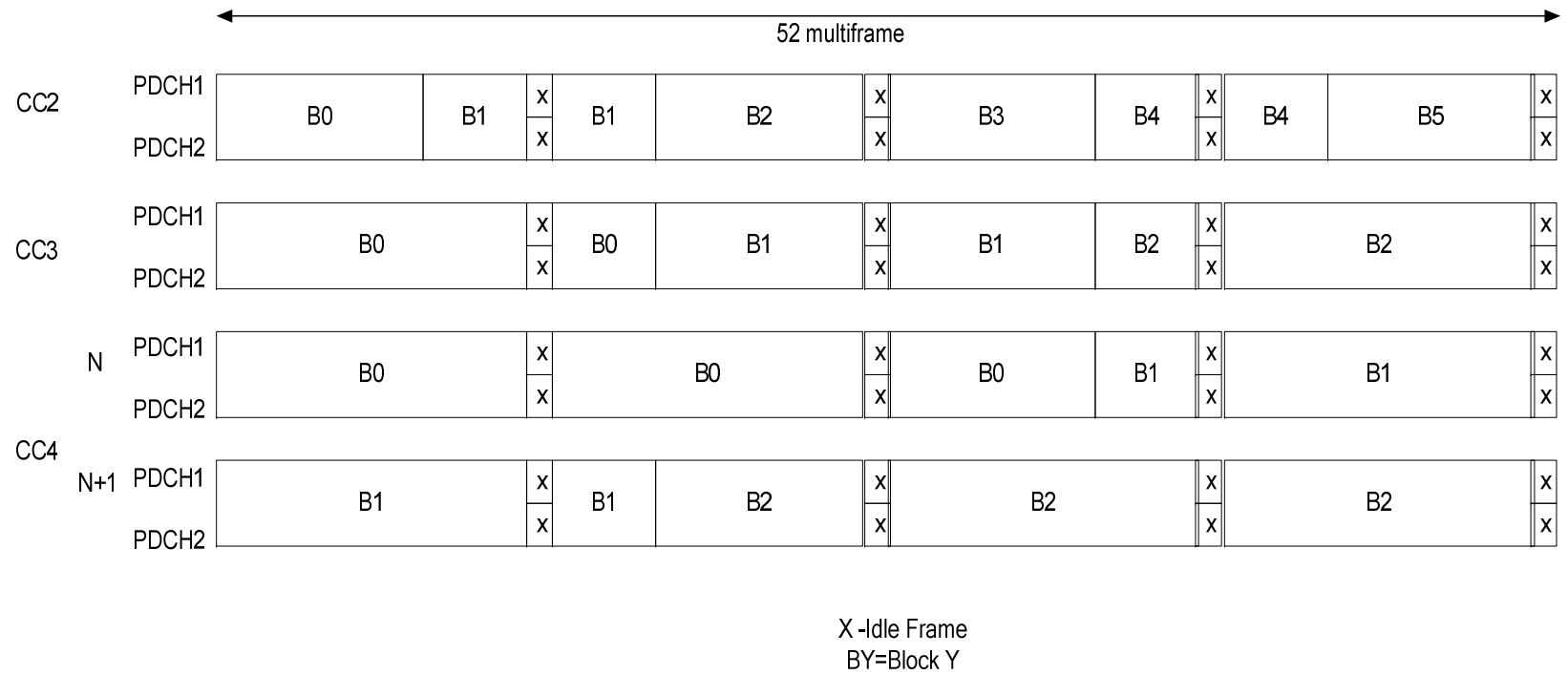

**Figure 9c: 52-multiframe for EC-GSM-IoT for different Coverage Classes (CC) using 2 PDCHs for CC2 to CC4 in EC operation**

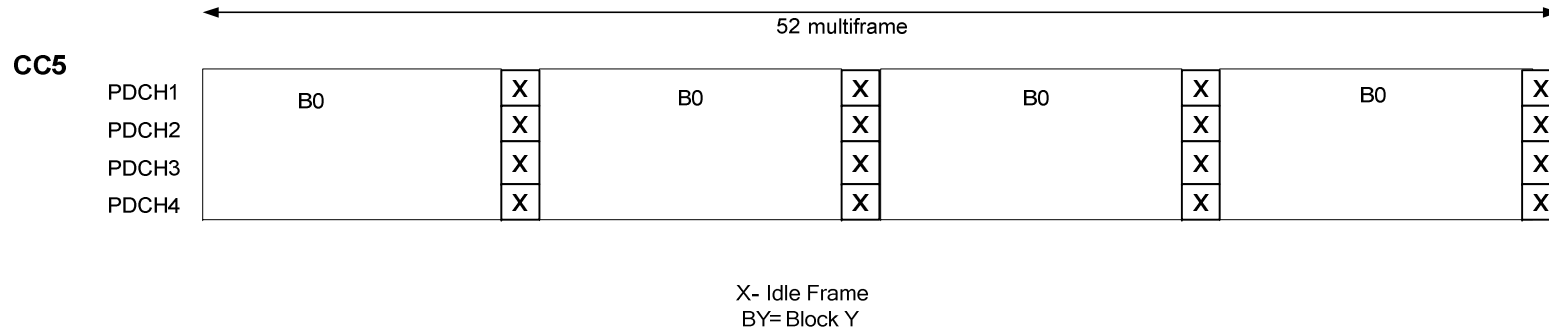

**Figure 9d: 52-multiframe for EC-GSM-IoT for uplink Coverage Class CC5 using 4 PDCHs in EC operation**

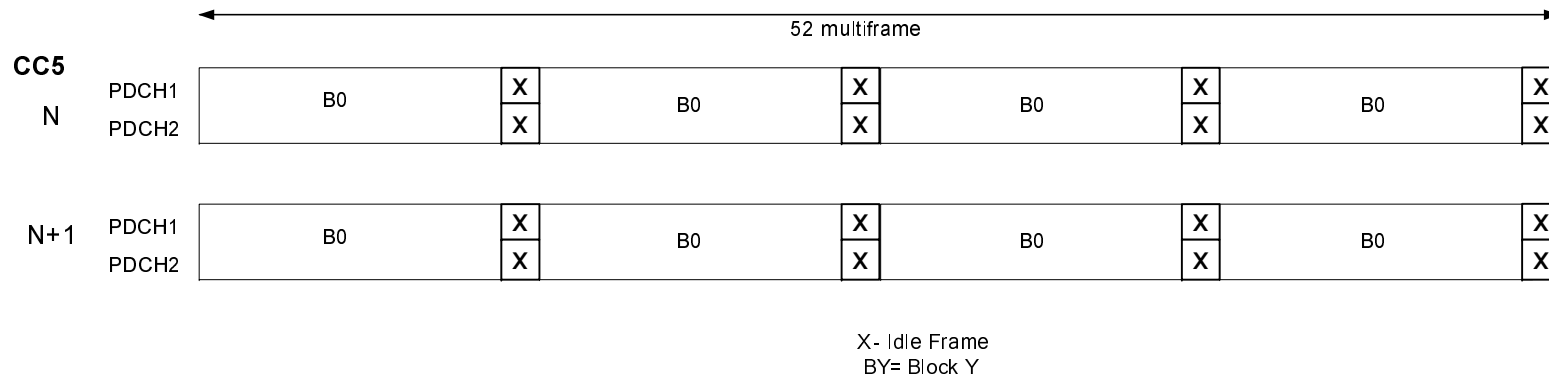

**Figure 9e: Two 52-multiframes for EC-GSM-IoT for uplink Coverage Class CC5 using 2 PDCHs in EC operation**

52 TDMA Frames

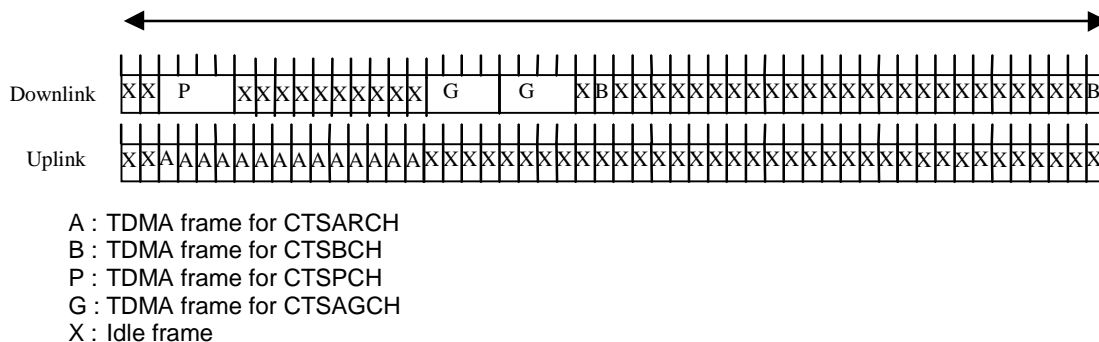

Figure 10: 52-multiframe for CTS

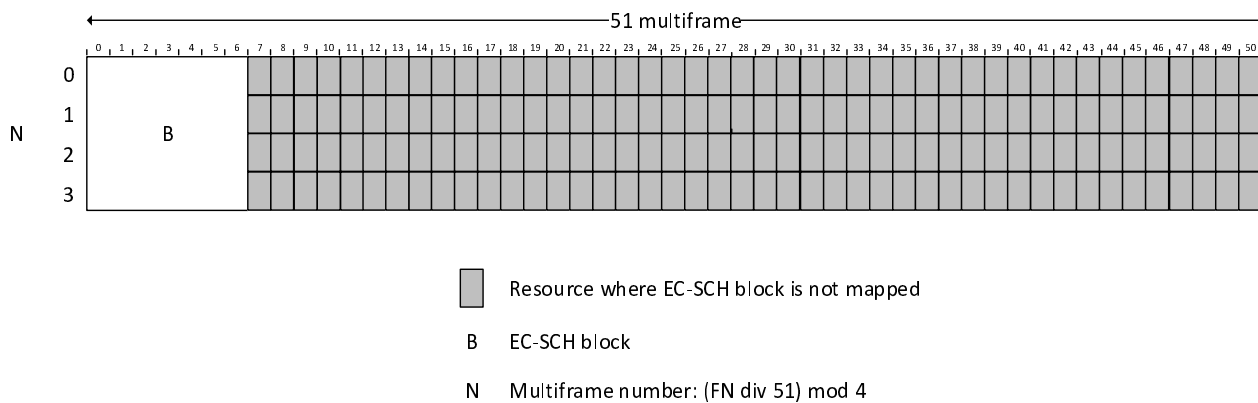

Figure 11: TDMA frame mapping for EC-SCH

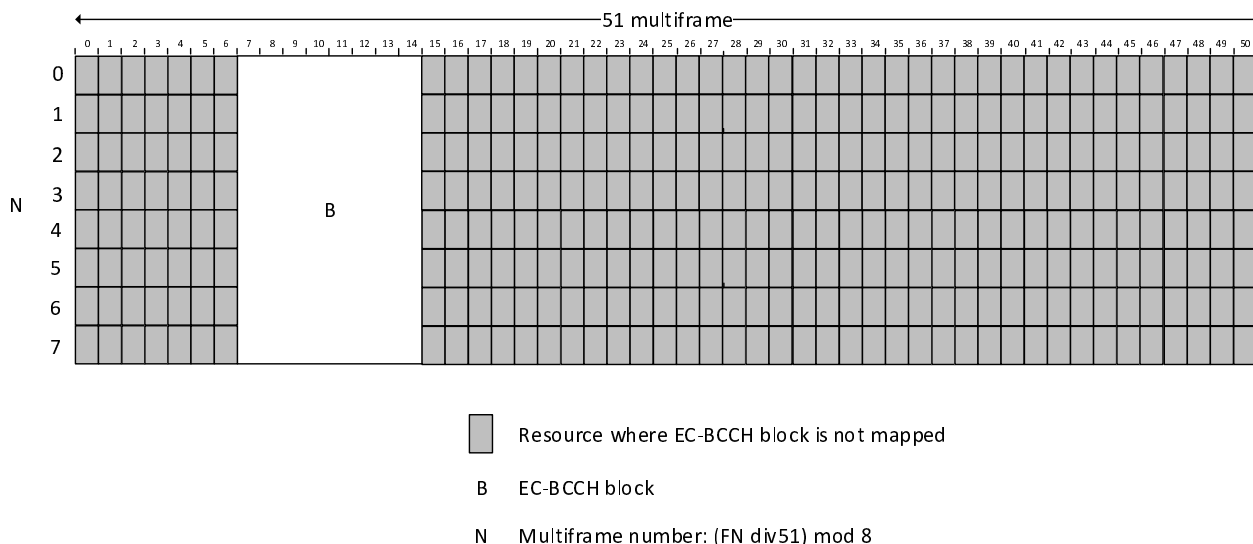

Figure 12: TDMA frame mapping for EC-BCCH

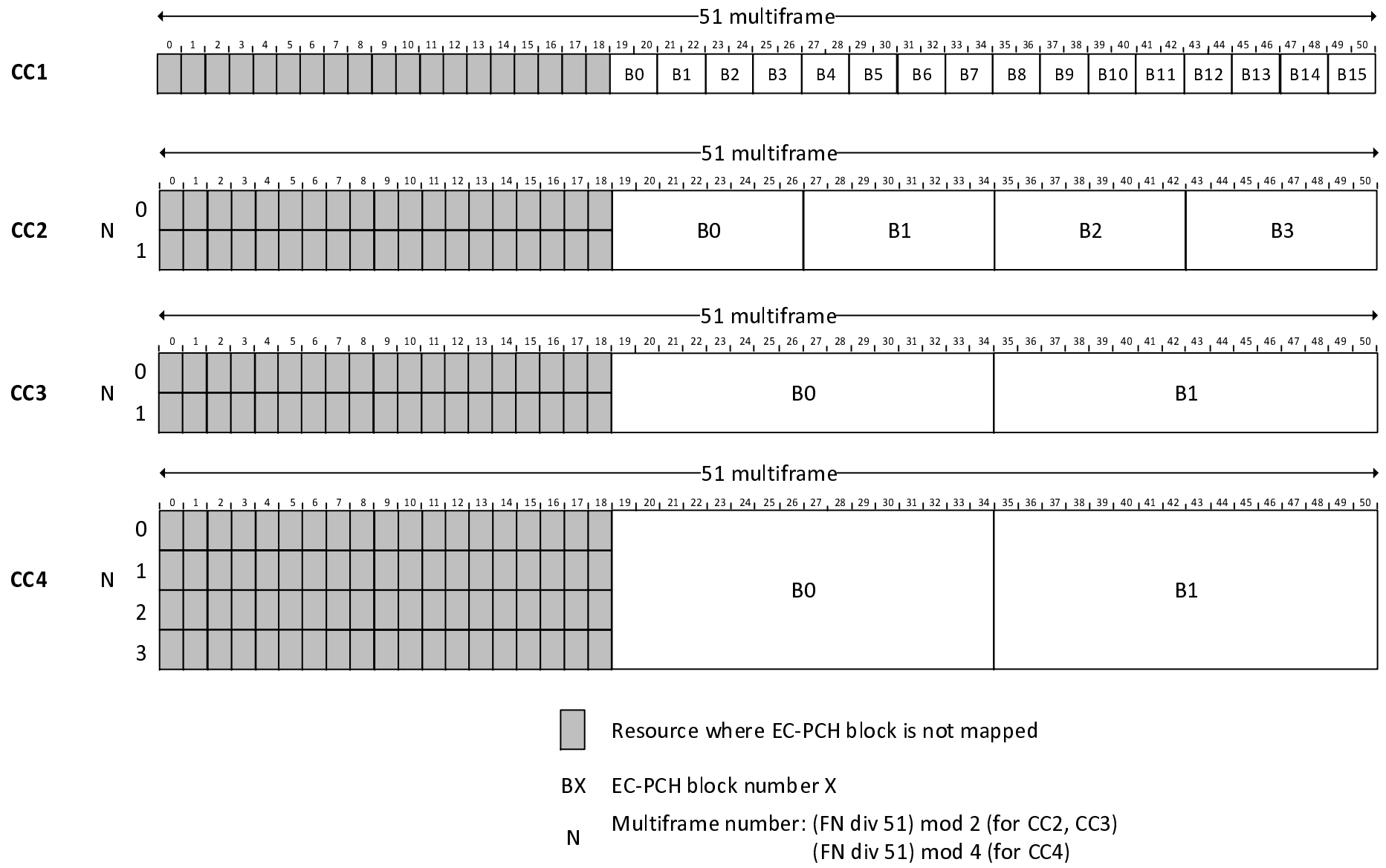

Figure 13: TDMA frame mapping for EC-PCH

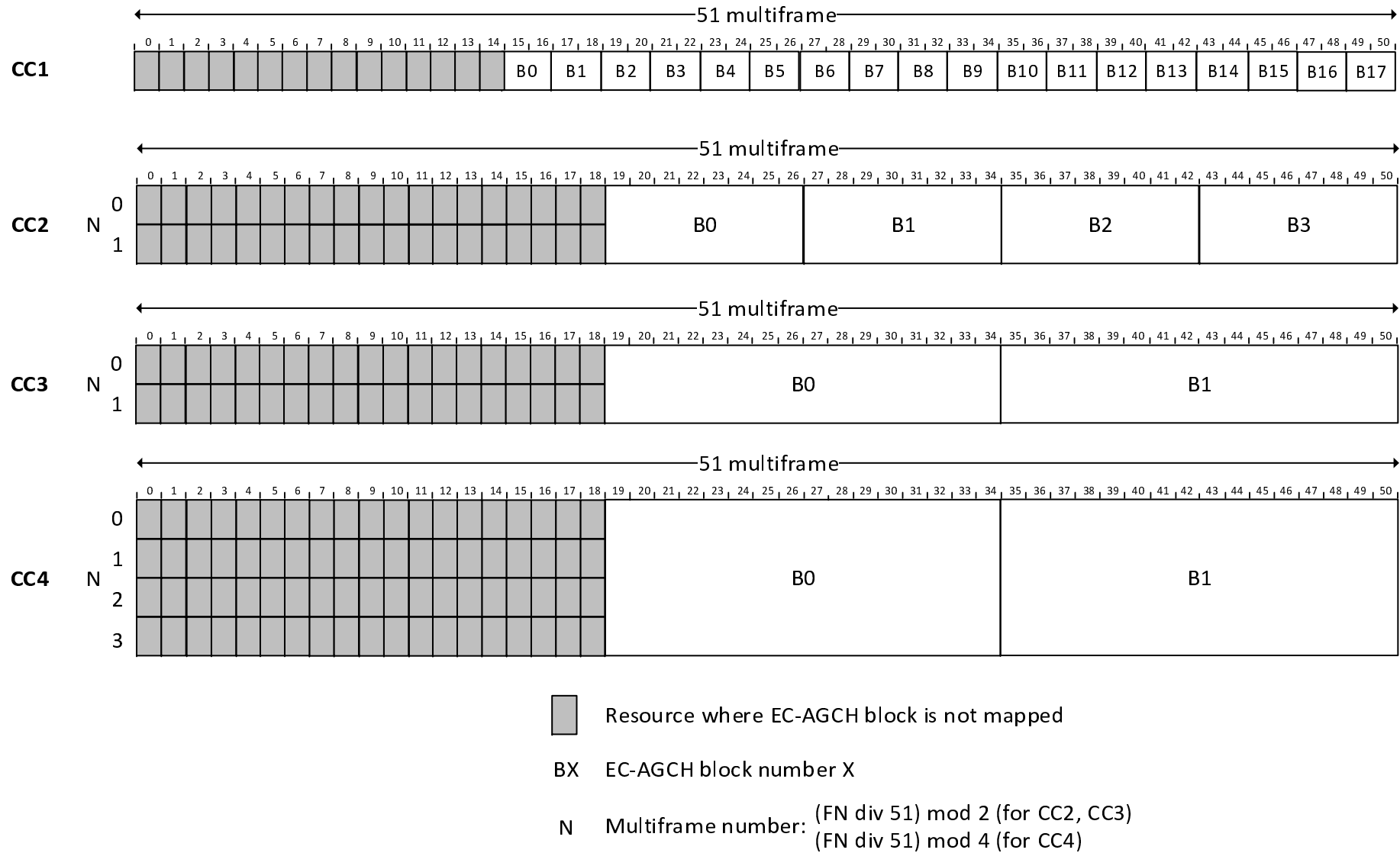

Figure 14: TDMA frame mapping for EC-AGCH on timeslot number 1 without EC-PICH



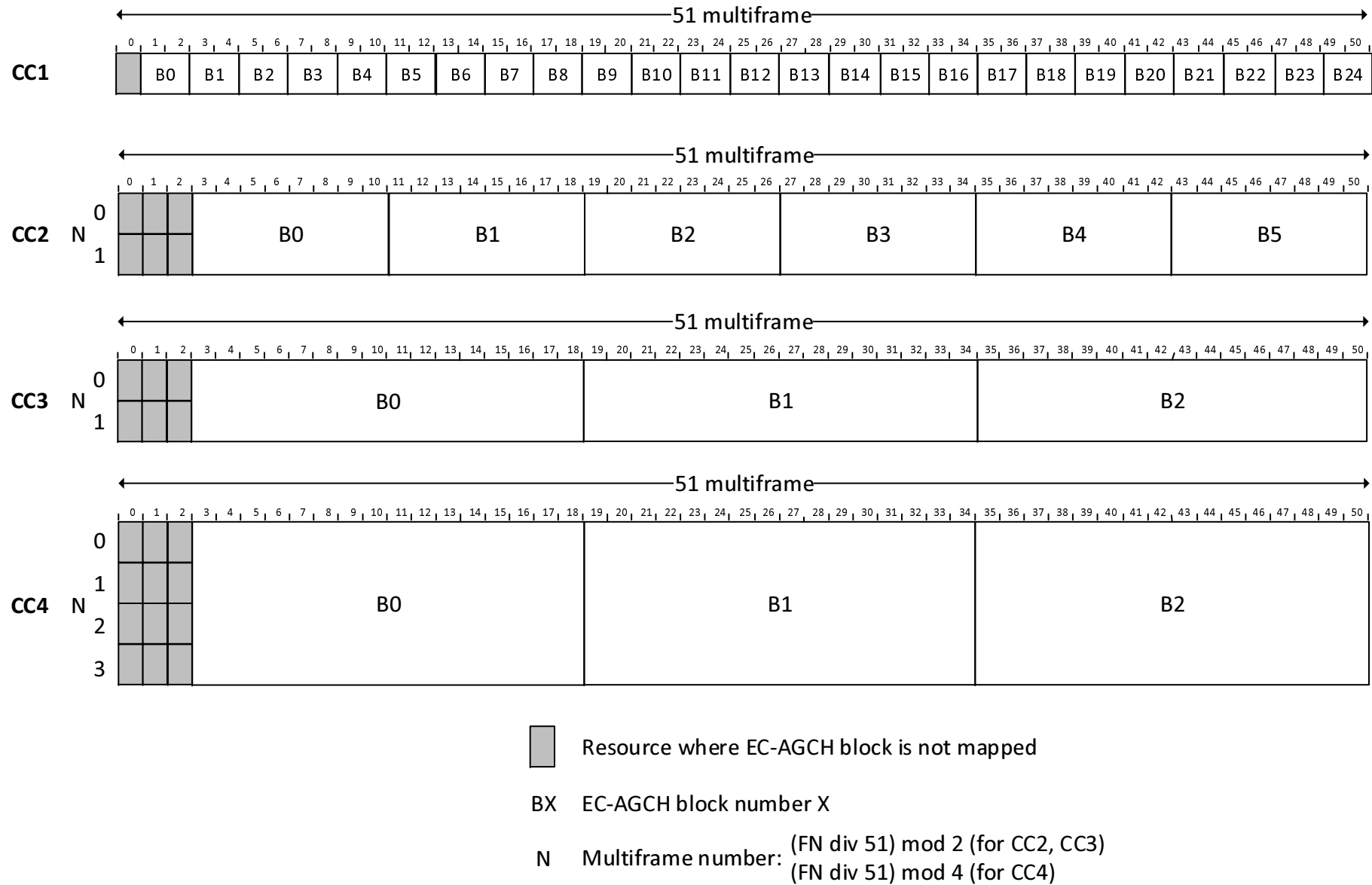

Figure 15: TDMA frame mapping for EC-AGCH on timeslot number 3,5 and 7 without EC-PICH

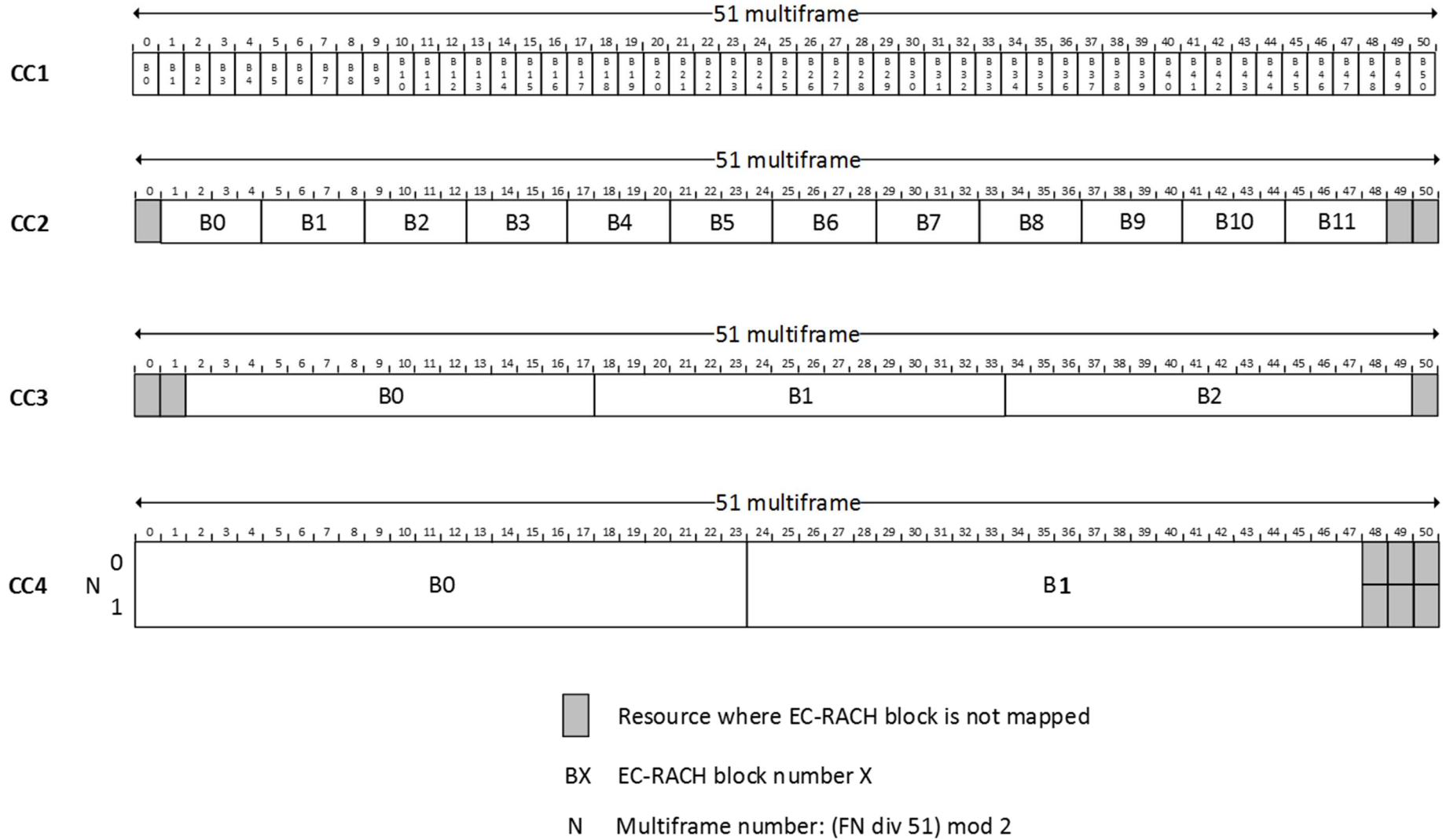

Figure 16: TDMA frame mapping for 1TS EC-RACH

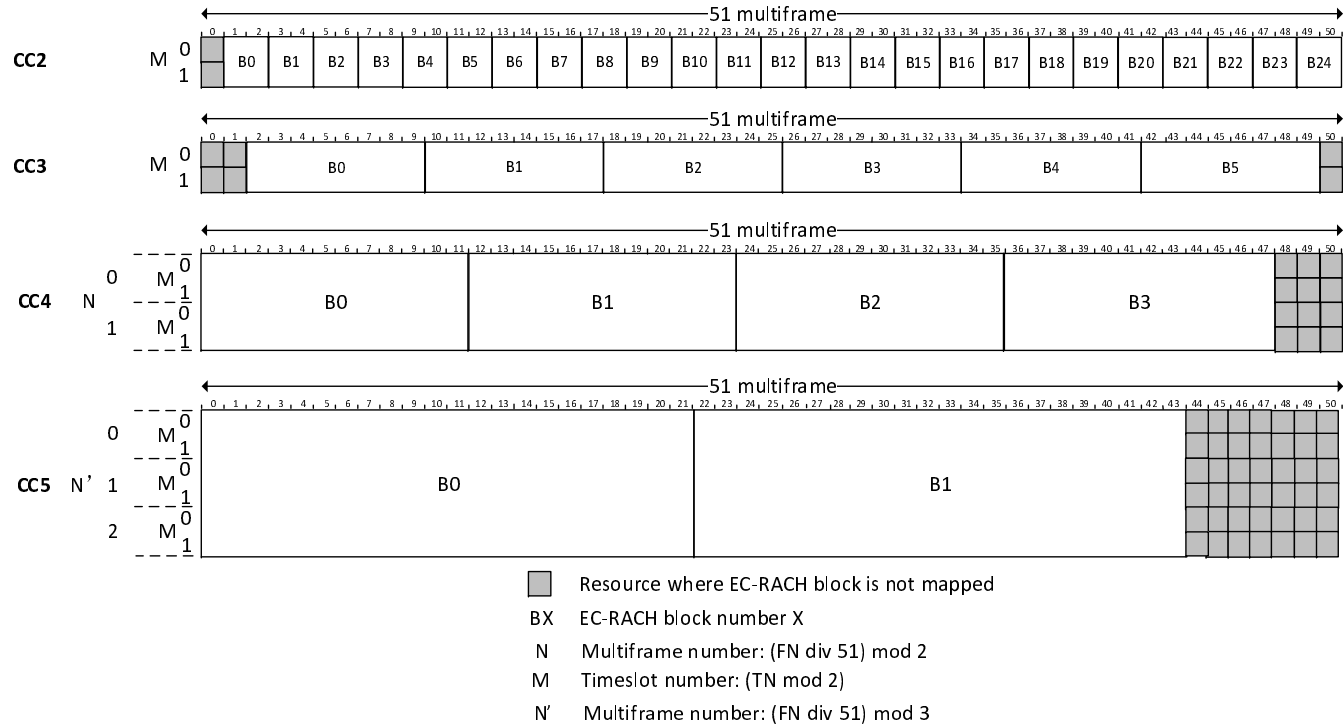
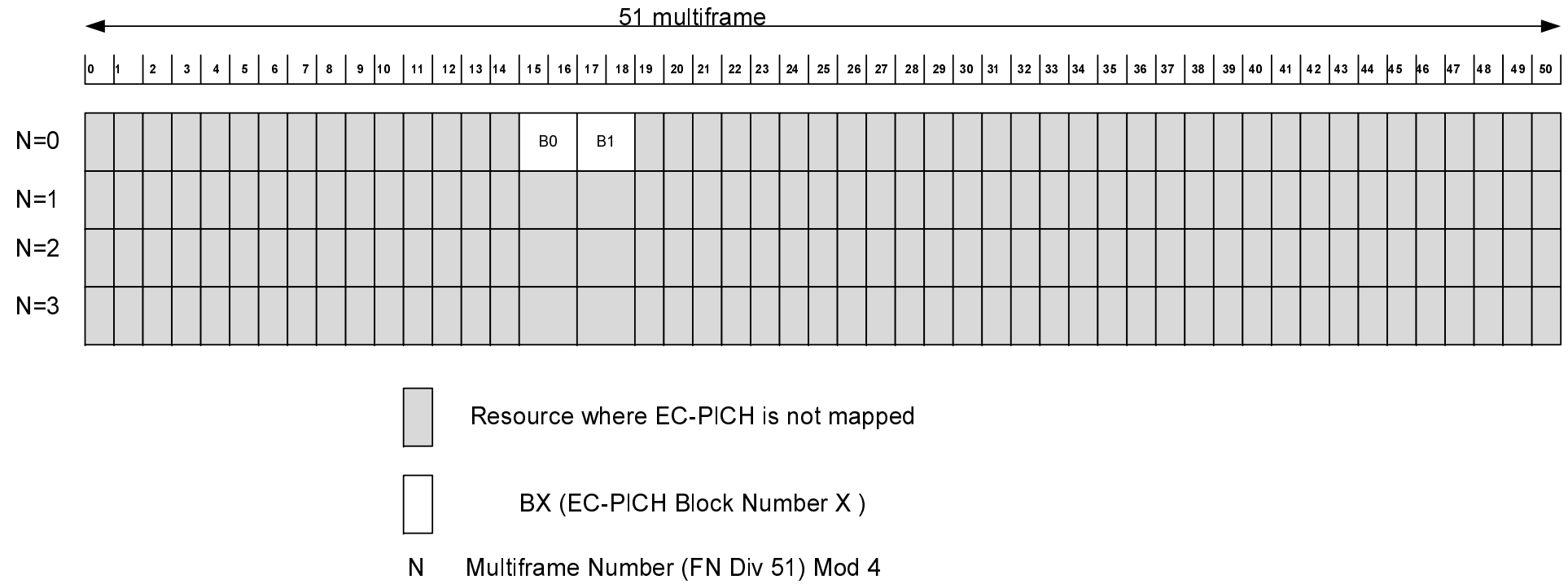

Figure 17: TDMA frame mapping for 2TS EC-RACH



**Figure 18: TDMA frame mapping for EC-PICH CC4 in TN1**





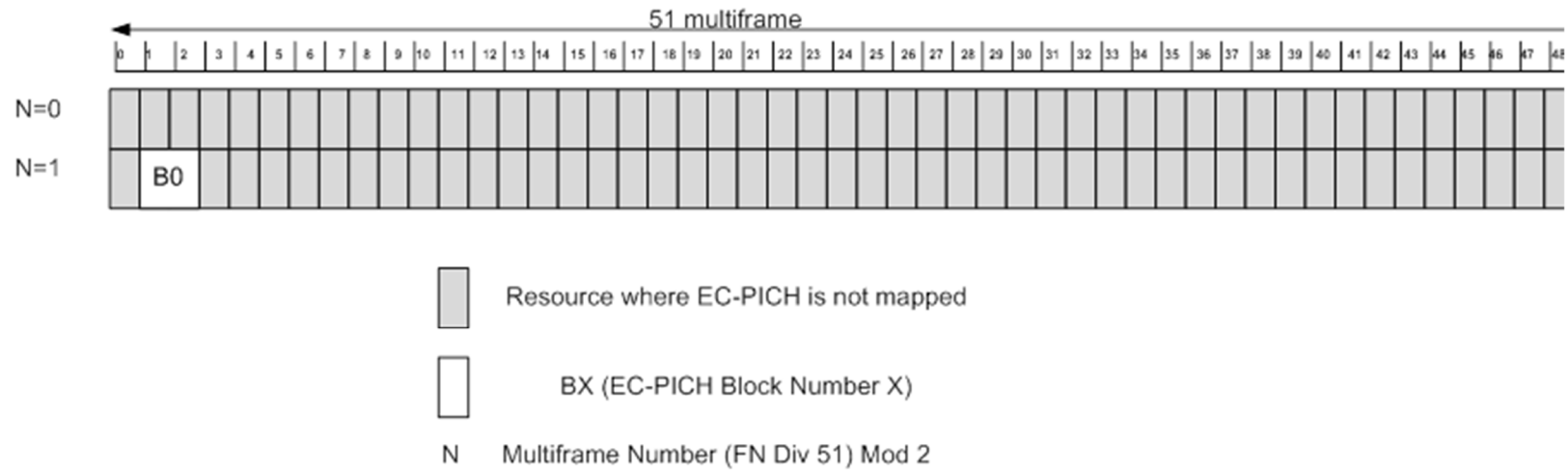

Figure 21: TDMA frame mapping for EC-PICH CC3 in TN3, TN5, TN7

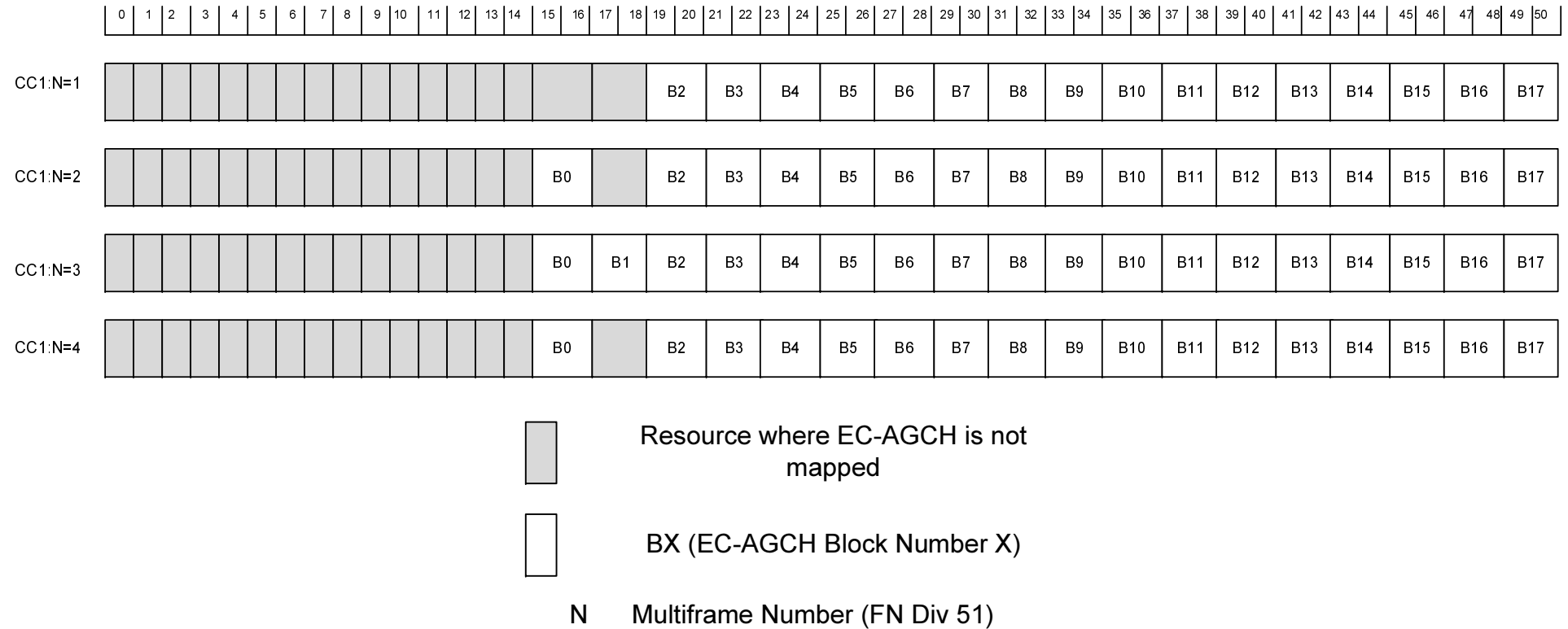

Figure 22: TDMA frame mapping for EC-AGCH for CC1 in TN1 with EC-PICH configured



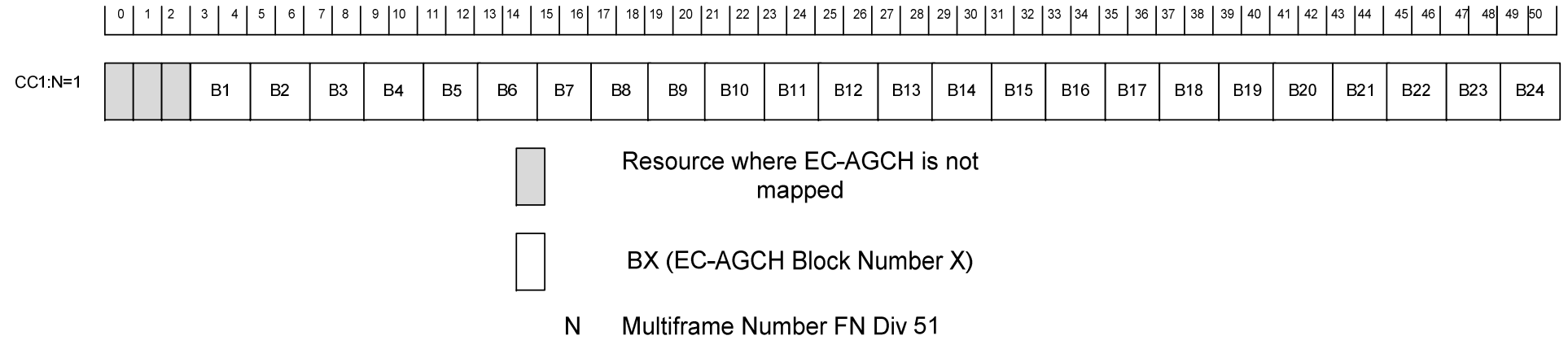

Figure 23: TDMA frame mapping for EC-AGCH for CC1 in TN3, TN5 and TN7 with EC-PICH configured

---

## 8 Flexible layer one

### 8.1 General

With FLO, the physical layer offers transport channels to upper layers. In each direction, one or several transport channels can be processed and multiplexed together by the same coding and multiplexing unit. The detailed functions of the coding and multiplexing unit are defined in 3GPP TS 45.003.

### 8.2 Transport channels

The offered transport channels are Dedicated CHannels (DCHs). DCHs are unidirectional and used to carry user or control data on DBPSCH. Depending on the channel mode of the DBPSCH on which they are used, two general forms of DCH are defined:

- i) Full rate DCH (DCH/F). This channel carries information at a maximum gross rate of 68.5 kbit/s and shall only be used on DBPSCH/F.
- ii) Half rate DCH (DCH/H). This channel carries information at a maximum gross rate of 34.1 kbit/s and shall only be used on DBPSCH/H.

### 8.3 Mapping of transport channels onto physical channels

#### 8.3.1 General

The detailed mapping of transport channels onto physical channels is defined in the following sections. Subclause 8.3.2 defines the mapping from TDMA frame number (FN) to radio frequency channel (RFCH). Subclause 8.3.3 defines the mapping of the physical channel onto TDMA frame number. Subclause 8.3.4 lists the permitted channel combinations and subclause 8.3.5 defines the multislot configurations.

#### 8.3.2 Mapping in frequency of transport channels onto physical channels

The mapping from TDMA frame number (FN) to radio frequency channel (RFCH) is done as specified in subclause 6.2.

#### 8.3.3 Mapping in time of transport channels onto physical channels

For each DBPSCH using FLO, every transmission time interval (TTI), one or several DCHs are processed and multiplexed together by the same coding and multiplexing unit. The single output data block from the coding and multiplexing unit is called a radio packet and it shall be mapped onto one and only one DBPSCH. The radio packet is then interleaved on bursts according to the channel mode and interleaving scheme chosen by layer 3 (see 3GPP TR 45.902 and 3GPP TS 44.118).

The mapping in time of radio packets is defined in table 8.3.3 below where the columns headed:

- i) "DBPSCH configuration" defines the configuration of the DBPSCH in terms of channel mode (full rate or half rate) and interleaving scheme (4 bursts rectangular, 8 bursts diagonal or 4 bursts diagonal).
- ii) "Sub-channel number" identifies the particular sub-channel being defined where a DBPSCH supports more than one channel of this type.
- iii) "Direction" defines whether the mapping given applies identically to downlink and uplink (D&U), or to downlink (D) or uplink (U) only.
- iv) "Allowable timeslots assignments" defines whether FLO can be supported on, or assigned to, any of the timeslots, or only on specific timeslots.

- v) "Allowable RF channel assignments" defines whether FLO can use any or all of the radio frequency channels in the cell allocation (CA), or only the BCCH carrier (C0). It should be noted that any allocated channel Cx within CA could be any radio frequency channel, and that no ordering of radio frequency channel number is implied. For example, allocated channel C0 need not have the lowest radio frequency channel number of the allocation.
- vi) "Burst type" defines which type of burst as defined in clause 5.2 is to be used for the physical channel.
- vii) "Repeat length in TDMA frames" defines how many TDMA frames occur before the mapping for the interleaved radio packets repeats itself.
- viii) "Interleaved radio packet TDMA frame mapping" defines, within the parentheses, the TDMA frames used by each interleaved radio packet (e.g. 0..3). The numbers given equate to the TDMA frame number (FN) modulo the number of TDMA frames per repeat length; Therefore, the frame is utilized when:

TDMA frame mapping number = (FN)mod (repeat length)

Where there is more than one radio packet shown, each radio packet is given a separate designation e.g. B0, B1. Where diagonal interleaving is employed then all of the TDMA frames included in the radio packet are given, and hence the same TDMA frame number can appear more than once (see 3GPP TS 45.003).

Table 8.3.3: Mapping of radio packets onto physical channels

DBPSCH Configuration	Sub-channel number	Direction assignments	Allowable time slot assignments	Allowable RF channel type	Burst in TDMA frames	Repeat length	Interleaved radio packet TDMA frame mapping
full rate channel (DBPSCH/F) 8 bursts diagonal interleaving	D&U	0 ... 7	C0 ... Cn	NB <sup>1</sup>	13B0(0...7), B1(4...11), B2(8...11,0...3)		
full rate channel (DBPSCH/F) 4 bursts rectangular interleaving	D&U	0 ... 7	C0 ... Cn	NB <sup>1</sup>	13 B0(0...3), B2(4...7), B3(8...11)		
half rate channel (DBPSCH/H) 4 bursts diagonal interleaving	0 1	D&U	0 ... 7 B0(1,3,5,7), B1(5,7,9,11), B2(9,11,1,3)	C0 ... Cn	NB <sup>1</sup>	13	B0(0,2,4,6), B1(4,6,8,10), B2(8,10,0,2)

NOTE 1: An Access Burst (AB) is used on the uplink during handover.

### 8.3.4 Permitted channel combinations onto a basic physical subchannel

Four principles regulate the channel combinations with FLO:

- DCHs shall only be mapped on DBPSCH.
- On the same DBPSCH, a maximum of 8 DCHs may be allocated.
- In the same radio packet, a maximum of 4 DCHs may be processed and multiplexed together by the coding and multiplexing unit.
- With the exception of the SACCH, logical channels and transport channels shall not be mapped onto the same DBPSCH.

The following are the permitted ways in which channels can be combined onto one DBPSCH/F for one MS:

- f1) DCH/F(s) + SACCH/TF
- f2) DCH/F(s) + SACCH/M
- f3) DCH/F(s) + SACCH/MD
- f4) DCH/F(s) + SACCH/TPF + EPCCH/F
- f5) DCH/F(s) + SACCH/MP + EPCCH/M
- f6) DCH/F(s) + SACCH/MPD + EPCCH/MD

NOTE 1: the number of DCHs may be different in uplink and downlink.

NOTE 2: Combinations f2) and f3) are used without EPC in multislot configurations as defined in subclause 8.3.5.

NOTE 3: Combinations f5) and f6) are used with EPC in multislot configurations as defined in subclause 8.3.5.

The following definitions are used in the list of half rate combinations below.

<u>Combination designation</u>	<u>Channel combination</u>
SUB_FA	DCH/H(s) + SACCH/TH
SUB_FE	DCH/H(s) + SACCH/TPH + EPCCH/H

The following are the permitted ways in which channels can be combined onto one basic physical channel for two MSs on two DBPSCH/H:

- g1) SUB\_FA + SUB\_FA
- g2) SUB\_FA + SUB\_FE
- g3) SUB\_FE + SUB\_FE
- g4) SUB\_TA + SUB\_FA
- g5) SUB\_TA + SUB\_FE
- g6) SUB\_TE + SUB\_FA
- g7) SUB\_TE + SUB\_FE
- g8) SUB\_OTA + SUB\_FA
- g9) SUB\_OTA + SUB\_FE

g10) SUB\_OTE + SUB\_FA

g11) SUB\_OTE + SUB\_FE

## 8.3.5 Multislot configurations

### 8.3.5.1 Multislot configurations for DBPSCHs assigned

A multislot configuration consists of multiple DBPSCH/F assigned to the same MS. The multislot configuration occupies up to 8 basic physical channels, with different timeslots numbers (TN) but with the same frequency parameters (ARFCN or MA, MAIO and HSN) and the same training sequence (TSC).

Two types of multislot configurations exist, symmetric and asymmetric. The symmetric case consists of only bi-directional channels. The asymmetric case consists of both bi-directional and unidirectional downlink channels.

The occupied physical channels shall consist of the following channel combinations as defined in subclause 8.3.4.

x channels of type f2) +

y channels of type f3)

When in EPC mode (see 3GPP TS 45.008) the occupied physical channels shall consist of the following channel combinations as defined in subclause 8.3.4.

x channels of type f5) +

y channels of type f6)

where  $1 \leq x \leq 8$ ,  $y = 0$  for symmetric multislot configuration

$1 \leq x \leq 7$ ,  $1 \leq y \leq 7$ ,  $x+y \leq 8$  for asymmetric multislot configuration

The assignment of channels to a Multislot Configuration must always consider the multislot capability of the MS, as defined by the multislot class described in annex B.

### 8.3.5.2 Multislot configurations for dual transfer mode in lu mode

The multislot configuration for dual transfer mode in *lu mode* is the same as in 6.4.2.7. The only difference is that FLO is used on the assigned DBPSCHs.

## Annex A (normative): Phase 2 mobiles in a Phase 1 infrastructure

### A.1 Scope

Phase 2 mobiles are required to behave properly in a Phase 1 networks, when downlink DTX is used in conjunction with frequency hopping.

### A.2 Implementation options for TCH channels

#### A.2.1 C0 filling on the TCH

When the TCH is active, and no associated traffic frame is scheduled for transmission, the following options apply for filling the burst on the C0 radio frequency channel.

A.2.1.1 A dummy burst with (BN61, BN62, BN86) = training sequence bits of normal bursts

A.2.1.2 A dummy burst with the "C0 filling training sequence

(BN61, BN62, BN86) = (0,1,1,1,0,0,0,1,0,1,1,1,0,0,0,1,0,1,1,1,0,0,0,1,0,1).

A.2.1.3 A dummy burst with ( BN61, BN62, BN86) mapped from the TSC bits of normal bursts according to the table

TSC from TSC set 1 for other bursts on TCH	Dummy bursts (BN61, BN62 BN86)	Corresponding TSC from TSC set 1
0	(0,1,0,0,0,0,1,1,1,0,1,1,1,0,1,0,0,1,0,0,0,0,1,1,1,0)	2
1	(0,1,0,0,1,1,1,0,1,0,1,1,0,0,0,0,0,1,0,0,1,1,1,0,1,0)	5
2	(0,0,1,0,0,1,0,1,0,1,1,0,0,0,0,1,0,0,0,1,0,0,1,0,1,1)	0
3	(0,0,0,1,1,0,1,0,1,1,1,0,0,1,0,0,0,0,0,1,1,0,1,0,1,1)	4
4	(0,1,0,0,1,1,1,0,1,0,1,1,0,0,0,0,0,1,0,0,1,1,1,0,1,0)	5
5	(0,1,0,0,0,0,1,1,1,0,1,1,1,0,1,0,0,1,0,0,0,0,1,1,1,0)	2
6	(0,1,0,0,0,1,1,1,1,0,1,1,0,1,0,0,0,1,0,0,0,1,1,1,1,0)	3
7	(0,1,0,0,1,1,1,0,1,0,1,1,0,0,0,0,0,1,0,0,1,1,1,0,1,0)	5

#### A.2.1.4 Partial SID information

The BTS transmits bursts containing parts of the SID frames provided by the speech encoder. The bits transmitted in such bursts on C0 carrier contain the same bits that would have been transmitted in those bursts in those if the associated traffic frames were scheduled for transmission.

### A.2.2 Half burst filling

For downlink DTX, when a given traffic frame is scheduled for transmission and one of its adjacent traffic frames is not scheduled for transmission, half of the "encrypted bits" belonging to the normal bursts associated with the scheduled traffic frame need to be filled. These bits are referred to as "half burst filling bits". These half bursts filling bits contain either.

A.2.2.1 Partial SID information from any associated SID frame; or

A.2.2.2 The mixed bits of the dummy bursts (encrypted or not encrypted)

### A.2.3 Dummy burst Stealing flag

The dummy burst stealing flag are set to either 1 or 0.

### A.2.4 Half burst Filling Stealing flag

BN60 or BN87 corresponding to the "encrypted bits" of a filled half burst, defined as the "half burst filling stealing flag", are jointly set to a value of either 1 or 0.

### A.2.5 Allowed combinations

Table A.2.5.1 below provides the allowed combinations for phase 1 networks supporting downlink DTX in conjunction with frequency hopping.

**Table A.2.5.1: Possible combinations for networks supporting downlink DT in conjunction with frequency hopping**

Combination	C0 filling on the TCH	Half Burst filling	Dummy Bursts Stealing Flag	Half Burst Filling Stealing Flag
1	Dummy bursts with (BN61-BN86) equal to the bits of the TSC of the other normal bursts (A 2.1.1)	not defined	0	0
2	Dummy burst with "C0 filling training sequence" (A 2.1.2)	Partial SID information (A 2.2.1)	0	0
3	Dummy burst with (BN61, BN62....BN86) mapped from the TSC bits of normal bursts (A 2.1.3)	Partial SID information (A 2.2.1)	0	0
4	Partial SID information (A 2.1.4)	Partial SID information (A 2.2.1)	1	1
5	Dummy burst with "C0 filling training sequence" (A 2.1.2)	Dummy burst mixed bits (A 2.2.2)	1	1
6 (for DCS 1 800 only)	Partial SID information (A 2.1.4)	Partial SID information (A 2.2.1)	0	0

## A.3 Idle Channels

When a channel is idle, a dummy burst may be transmitted on C0 frequency channel with any options described in subclauses A 2.1.1, A 2.1.2, A 2.1.3.



## Annex B (normative): Multislot capability

### B.1 MS classes for multislot capability

When an MS supports the use of multiple timeslots it shall belong to a multislot class as defined below:

Table B.1

Multislot class	Maximum number of slots			Minimum number of slots				Type
	Rx	Tx	Sum	T <sub>ta</sub>	T <sub>tb</sub>	T <sub>ra</sub>	T <sub>rb</sub>	
1	1	1	2	3	2	4	2	1
2	2	1	3	3	2	3	1	1
3	2	2	3	3	2	3	1	1
4	3	1	4	3	1	3	1	1
5	2	2	4	3	1	3	1	1
6	3	2	4	3	1	3	1	1
7	3	3	4	3	1	3	1	1
8	4	1	5	3	1	2	1	1
9	3	2	5	3	1	2	1	1
10	4	2	5	3	1	2	1	1
11	4	3	5	3	1	2	1	1
12	4	4	5	2	1	2	1	1
13	3	3	NA	NA	a)	3	a)	2
14	4	4	NA	NA	a)	3	a)	2
15	5	5	NA	NA	a)	3	a)	2
16	6	6	NA	NA	a)	2	a)	2
17	7	7	NA	NA	a)	1	0	2
18	8	8	NA	NA	0	0	0	2
19	6	2	NA	3	b)	2	c)	1
20	6	3	NA	3	b)	2	c)	1
21	6	4	NA	3	b)	2	c)	1
22	6	4	NA	2	b)	2	c)	1
23	6	6	NA	2	b)	2	c)	1
24	8	2	NA	3	b)	2	d)	1
25	8	3	NA	3	b)	2	d)	1
26	8	4	NA	3	b)	2	d)	1
27	8	4	NA	2	b)	2	d)	1
28	8	6	NA	2	b)	2	d)	1
29	8	8	NA	2	b)	2	d)	1
30	5	1	6	2	1	1	1	1
31	5	2	6	2	1	1	1	1
32	5	3	6	2	1	1	1	1
33	5	4	6	2	1	1	1	1
34	5	5	6	2	1	1	1	1
35	5	1	6	2	1	1+to	1	1
36	5	2	6	2	1	1+to	1	1
37	5	3	6	2	1	1+to	1	1
38	5	4	6	2	1	1+to	1	1
39	5	5	6	2	1	1+to	1	1
40	6	1	7	1	1	1	to	1
41	6	2	7	1	1	1	to	1
42	6	3	7	1	1	1	to	1
43	6	4	7	1	1	1	to	1
44	6	5	7	1	1	1	to	1
45	6	6	7	1	1	1	to	1

a) = 1 with frequency hopping.

= 0 without frequency hopping.

b) = 1 with frequency hopping or change from Rx to Tx.

= 0 without frequency hopping and no change from Rx to Tx.

c) = 1 with frequency hopping or change from Tx to Rx.

= 0 without frequency hopping and no change from Tx to Rx.

d) = 1 change from Tx to Rx, or, with frequency hopping and the MS is either assigned a downlink dual carrier or DLMC configuration, or, the MS does not support fast downlink frequency switching (see 3GPP TS 24.008).

= 0 no change from Tx to Rx and either without frequency hopping or the MS is not assigned a downlink dual carrier configuration and supports fast downlink frequency switching (see 3GPP TS 24.008).

to = 31 symbol periods (this can be provided by a TA offset, i.e. a minimum TA value).

Type 1 MS are not required to transmit and receive at the same time.

Type 2 MS are required to be able to transmit and receive at the same time.

For HSCSD, only multislot classes 1 - 18 are recognised. An MS with a higher multislot class number shall indicate a suitable multislot class less than 19 for HSCSD applications (see 3GPP TS 44.018).

EC operation is only defined for Type 1 MS and hence only the multislot classes for Type 1 MS apply in Table B.1. Furthermore:

- 'Sum' does not apply since the MS is restricted to either transmit or receive during a TDMA frame.
- 'Rx' and 'Tx' only apply when blind physical layer transmissions are not used, i.e. when the MS is in CC1 on downlink and/or uplink respectively. When blind physical layer transmissions are used, the MS shall support four consecutive timeslots for transmission or reception, i.e. 'Tx=4' and 'Rx=4', irrespective of the declared multislot class.
- 'Tra' and 'Tta' do not apply since there is no requirement on downlink monitoring during an ongoing TBF.
- 'Ttb' does not apply since the time between reception of a Fixed Uplink Assignment and the corresponding Uplink allocation exceeds multiple TDMA frames.
- 'Trb' does not apply when assigning resource to an EC-GSM-IoT capable MS. The switching time can however apply for example after the MS has transmitted an EC-PACCH block on the uplink, before it can start monitoring the downlink, in which case the MS need not monitor downlink blocks where the 'Trb' is not fulfilled, see 3GPP TS 44.060.

#### **Rx:**

Rx describes the maximum number of receive timeslots that the MS can use per TDMA frame. The MS must be able to support all integer values of receive TS from 0 to Rx (depending on the services supported by the MS). The receive TS need not be contiguous. For type 1 MS, the receive TS shall be assigned within window of size Rx, and no transmit TS shall occur between receive TS within a TDMA frame.

#### **Tx:**

Tx describes the maximum number of transmit timeslots that the MS can use per TDMA frame. The MS must be able to support all integer values of transmit TS from 0 to Tx (depending on the services supported by the MS). The transmit TS need not be contiguous. For type 1 MS, the transmit TS shall be assigned within window of size Tx, and no receive TS shall occur between transmit TS within a TDMA frame.

#### **Sum:**

Sum is the total number of uplink (u) and downlink (d) TS that can actually be used by the MS per TDMA frame. The MS must be able to support all combinations of integer values of  $d \leq Rx$  and  $u \leq Tx$  TS where  $1 \leq d + u \leq Sum$  (depending on the services supported by the MS). Sum is not applicable to all classes.

Sum is not applicable in EC operation.

**T<sub>ta</sub>:**

T<sub>ta</sub> relates to the time needed for the MS to perform adjacent cell signal level measurement and get ready to transmit.

For type 1 MS it is the minimum number of timeslots that will be allowed between the end of the previous transmit or receive TS and the next transmit TS when measurement is to be performed between. It should be noted that, in practice, the minimum time allowed may be reduced by amount of timing advance.

For type 1 MS that supports extended TA, the parameter T<sub>ta</sub> is increased by 1 if TA > 63 and there is a change from RX to TX.

For type 2 MS it is not applicable.

For circuit switched multislot configurations as defined in subclause 6.4.2.1, T<sub>ta</sub> is not applicable.

T<sub>ta</sub> is not applicable in EC operation.

**T<sub>tb</sub>:**

T<sub>tb</sub> relates to the time needed for the MS to get ready to transmit. This minimum requirement will only be used when adjacent cell power measurements are not required by the service selected.

For type 1 MS it is the minimum number of timeslots that will be allowed between the end of the last previous receive TS and the first next transmit TS or between the previous transmit TS and the next transmit TS when the frequency is changed in between. It should be noted that, in practice, the minimum time allowed may be reduced by the amount of the timing advance.

For type 1 MS that supports extended TA, the parameter T<sub>tb</sub> = 2 if TA > 63 and there is a change from RX to TX.

For type 2 MS it is the minimum number of timeslots that will be allowed between the end of the last transmit burst in a TDMA frame and the first transmit burst in the next TDMA frame.

T<sub>tb</sub> is not applicable in EC operation.

**T<sub>ra</sub>:**

T<sub>ra</sub> relates to the time needed for the MS to perform adjacent cell signal level measurement and get ready to receive.

For type 1 MS it is the minimum number of timeslots that will be allowed between the previous transmit or receive TS and the next receive TS when measurement is to be performed between.

For type 2 MS it is the minimum number of timeslots that will be allowed between the end of the last receive burst in a TDMA frame and the first receive burst in the next TDMA frame.

An MS, except for multislot class 30 – 45, shall be able to decode SCH from a neighbour cell, independent of its relative timing, using an idle frame in combination with T<sub>ra</sub> from the preceding frame.

T<sub>ra</sub> is not applicable in EC operation.

**T<sub>rb</sub>:**

T<sub>rb</sub> relates to the time needed for the MS to get ready to receive. This minimum requirement will only be used when adjacent cell power measurements are not required by the service selected.

For type 1 MS it is the minimum number of timeslots that will be allowed between the previous transmit TS and the next receive TS or between the previous receive TS and the next receive TS when the frequency is changed in between.

For type 2 MS it is the minimum number of timeslots that will be allowed between the end of the last receive burst in a TDMA frame and the first receive burst in the next TDMA frame.

---

## B.2 Constraints imposed by the service selected

The service selected will impose certain restrictions on the allowed combinations of transmit and receive timeslots. Such restrictions are not imposed by this annex but should be derived from the description of the services. For example, in the case of circuit switched data the TS numbers used in the uplink will be a subset of those used in the downlink.

The service selected will determine whether or not adjacent cell power measurements are required and therefore whether  $T_{ra}$  or  $T_{rb}$  is allowed for.

---

## B.3 Network requirements for supporting MS multislots classes

The multislots class of the MS will limit the combinations and configurations allowed when supporting multislots communication.

GSM 400 network may support extended cell coverage utilising timing advance values greater than 63. This has an effect that the time for MS to change from RX to TX will be very short for distant MS. It is necessary for the network to decide whether requested or current multislots configuration can be supported by distant MS. If actual TA is great enough it may be necessary for network to downgrade requested resources or it may be necessary for network to downgrade current resources.

It is necessary for the network to decide whether the MS needs to perform adjacent cell power measurement for the type of multislots communication intended and whether the service imposes any other constraints before the full restrictions on TS assignments can be resolved. This is best shown by example:

For a multislots class 5 MS in circuit switched configuration (adjacent cell power measurements required) five basic configurations of channels are possible which can occur in six different positions in the TDMA frame. The service itself may determine that asymmetry must be downlink biased, in which case the last two solutions would not be allowed.

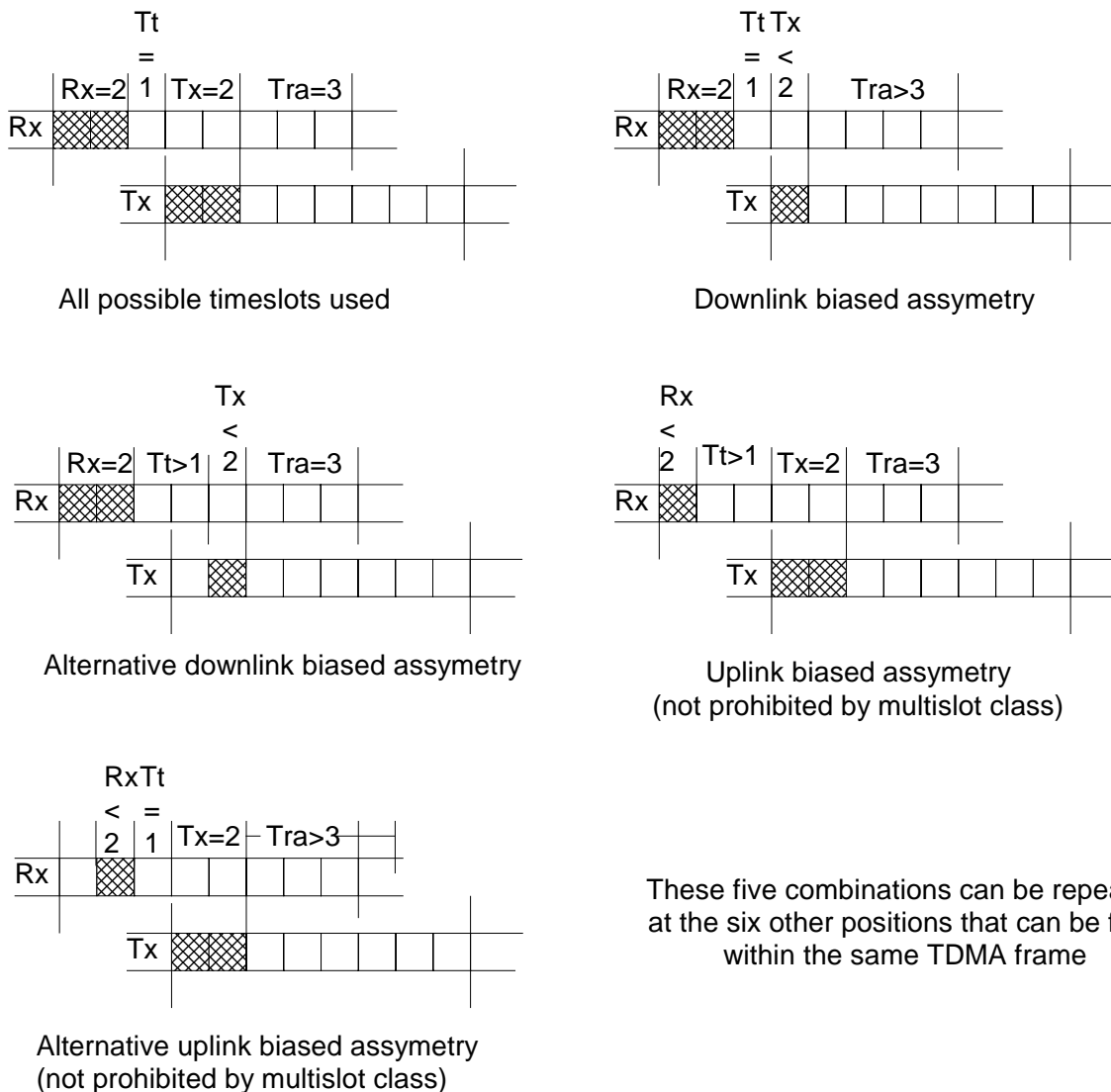

These five combinations can be repeated at the six other positions that can be fitted within the same TDMA frame

**Figure B.1**

For a multislot class 13 MS when adjacent cell power measurements are not required and the service does not constrain the transmit and receive timeslots to use the same timeslot number. Many configurations of channels are possible so long as the 5 constraints of the MS are catered for. [Currently services envisaged only allow for the last example here.]

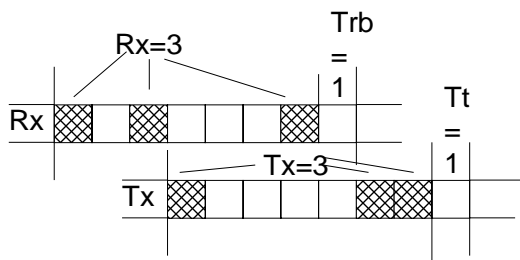

There is no requirement for relative timing of Tx timeslots in relation to Rx timeslots

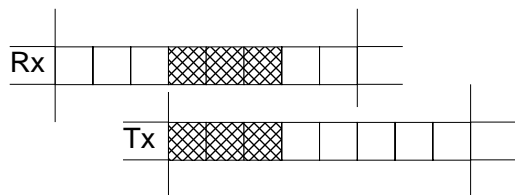

Many configurations are possible

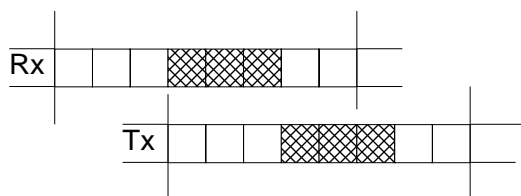
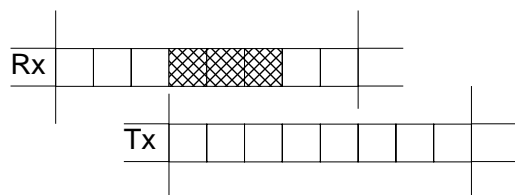
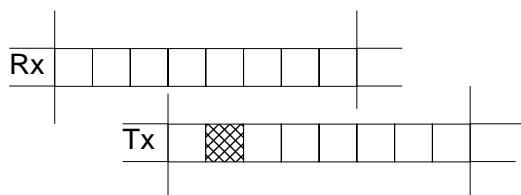

This configuration could be used for HSCSD or GPRS

Figure B.2

## B.4 Multislot capabilities for dual carrier mobile stations

For mobile stations supporting downlink dual carrier, the multislot capability applicable to dual carrier operation is dependent on the (DTM) EGPRS (high) multislot class (see subclause B.1), on the *Multislot Capability Reduction for Downlink Dual Carrier* field (see 3GPP TS 24.008) and, if provided, on the *Alternative EFTA multislot class* field (see subclause B.5) and on the *EFTA Multislot Capability Reduction for Downlink Dual Carrier* field (see 3GPP TS 24.008) as signalled by the mobile station as defined in Table B.2. Only mobile stations of multislot classes listed in Table B.2 can support downlink dual carrier.

Table B.2

Signalled multislot class	Alternative EFTA multislot class	Maximum Number of downlink timeslots	Equivalent multislot class when "Multislot Capability Reduction for Downlink Dual Carrier" IE indicates reduction of:		Note
			0 or 1 timeslots	2 or more timeslots	
8	-	10	30	8	-
10	-	10	31	10	-
11	-	10	32	11	-
12	-	10	33	12	-
30	-	10	-	-	-
31	-	10	-	-	-
32	-	10	-	-	-
33	-	10	-	-	-
34	-	10	-	-	-
35	-	10	-	-	-
36	-	10	-	-	-
37	-	10	-	-	-
38	-	10	-	-	-
39	-	10	-	-	-
40	-	12	-	-	-
41	-	12	-	-	-
42	-	12	-	-	-
43	-	12	-	-	-
44	-	12	-	-	-
45	-	12	-	-	-
30-39	None	10	-	-	0
40-45	None	12	-	-	0
30-39	1	12	-	-	0
30-45	2	14	-	-	0
30-45	3	16	-	-	0

NOTE 0: These configurations can only be used for assignment to an MS supporting Enhanced Flexible Timeslot Assignment (see 3GPP TS 24.008).

The values of Rx', Tx' and Sum' and Rx\_Sum apply for downlink dual carrier configurations.

If the MS has not indicated support for Enhanced Flexible Timeslot Assignment (see 3GPP TS 24.008), then Rx', Tx' and Sum' correspond to Rx, Tx and Sum for the Equivalent multislot class (see Table B.2) and the values of  $T_{ta}$ ,  $T_{tb}$ ,  $T_{ra}$  and  $T_{rb}$  of the equivalent multislot class shall then apply as indicated by Table B.2; if no equivalent multislot class is specified then Rx', Tx' and Sum' correspond to Rx, Tx and Sum respectively for the signalled multislot class and the switching times  $T_{ta}$ ,  $T_{tb}$ ,  $T_{ra}$  and  $T_{rb}$  of the signalled multislot class shall apply.

If the MS has indicated support for Enhanced Flexible Timeslot Assignment (see 3GPP TS 24.008), then Rx', Tx' and Sum',  $T_{ta}$ ,  $T_{tb}$ ,  $T_{ra}$  and  $T_{rb}$  all correspond to Rx, Tx, Sum,  $T_{ta}$ ,  $T_{tb}$ ,  $T_{ra}$  and  $T_{rb}$  respectively as defined in subclause B.5.

Possible switching and measurement timings for downlink dual carrier MSs that have a higher equivalent multislot class compared to the signalled multislot class are illustrated in Annex E.

Rx\_Sum is given by the *Maximum Number of downlink timeslots* as specified in Table B.2 minus the number of timeslots indicated in the *Multislot Capability Reduction for Downlink Dual Carrier* field (see 3GPP TS 24.008). If the resultant Rx\_Sum is lower than the value given by the field Sum in Table B.1 for the signalled multislot class (or the equivalent multislot class if different from signalled multislot class) (see Table B.2), then Rx\_Sum shall be assumed to be equal to Sum from Table B.1 for that multislot class.

If the MS has indicated support for Enhanced Flexible Timeslot Assignment (see 3GPP TS 24.008), then Rx\_Sum\_EFTA is given by the *Maximum Number of downlink timeslots* as specified in Table B.2 minus the number of timeslots indicated in the *EFTA Multislot Capability Reduction for Downlink Dual Carrier* field (see 3GPP TS 24.008). If the resultant Rx\_Sum\_EFTA is lower than or equal to the value given by the field Rx in Table B.1 either for the indicated alternative EFTA multislot class, or for the signalled (DTM) EGPRS (high) multislot class if no alternative

EFTA multislot class is indicated, then  $Rx\_Sum\_EFTA$  shall be assumed to be equal to  $Rx + 1$  from Table B.1 for that multislot class.

NOTE: The Equivalent multislot class and corresponding switching times (where different from the signalled multislot class) apply only for dual carrier assignments. For assignments which use only one carrier, the signalled multislot class (and corresponding switching times as specified in Table B.1) apply.

#### **Rx'**:

$Rx'$  describes the maximum number of receive timeslots that the MS can use per radio frequency channel per TDMA frame. The MS must be able to support all integer values of receive TS from 0 to  $Rx'$  (depending on the services supported by the MS) on each radio frequency channel. The receive TS need not be contiguous. For type 1 MS, all the receive TS (on both radio frequency channels) shall be allocated within a window of size  $Rx'$ , and no transmit TS shall occur between receive TS within a TDMA frame.

#### **Tx'**:

$Tx'$  describes the maximum number of transmit timeslots that the MS can use per TDMA frame. The MS must be able to support all integer values of transmit TS from 0 to  $Tx'$  (depending on the services supported by the MS). The transmit TS need not be contiguous. For type 1 MS, the transmit TS shall be allocated within window of size  $Tx'$ , and no receive TS shall occur between transmit TS within a TDMA frame.

NOTE: All transmit timeslots are allocated on the same uplink radio frequency channel within a radio block period.

#### **Sum'**:

$Sum'$  is the total number of uplink TS and downlink TS (on either radio frequency channel) that can be used by the MS per TDMA frame. The MS must be able to support all combinations of integer values of  $1 \leq d1 \leq Rx'$ ,  $1 \leq d2 \leq Rx'$  and  $u \leq Tx'$  TS where  $1 \leq d1 + u \leq Sum'$  and  $1 \leq d2 + u \leq Sum'$  (depending on the services supported by the MS).

#### **Rx\_Sum:**

$Rx\_Sum$  is the total number of downlink TS (on both radio frequency channels) that can be received by the MS per TDMA frame when not using Enhanced Flexible Timeslot Assignment, EFTA. The MS must be able to support all combinations of integer values of  $d1$  and  $d2$  where  $1 \leq d1 + d2 \leq Rx\_Sum$  (depending on the services supported by the MS).

#### **Rx\_Sum\_EFTA:**

$Rx\_Sum\_EFTA$  is the total number of downlink TS (on both radio frequency channels) that can be received by the MS per TDMA frame when using Enhanced Flexible Timeslot Assignment, EFTA. The MS must be able to support all combinations of integer values of  $d1$  and  $d2$  where  $1 \leq d1 + d2 \leq Rx\_Sum\_EFTA$  (depending on the services supported by the MS).

NOTE: Both  $d1$  and  $d2$  need to be different from 0 in order for  $Sum'$ ,  $Rx\_Sum$  and  $Rx\_Sum\_EFTA$  to apply.

---

## B.5 Multislot capabilities when EFTA is used

For mobile stations supporting Enhanced Flexible Timeslot Assignment, EFTA, the multislot capability parameters applicable to EFTA operation in a single carrier configuration are dependent on the signalled (DTM) EGPRS high multislot class (see subclause B.1) and on the Alternative EFTA multislot class (see Table B.3) indicated by the mobile station in the *MS Radio Access Capability* IE (see 3GPP TS 24.008).

The multislot capability parameters  $Rx$  and  $Tx$  shall be derived as follows:

- If no Alternative EFTA multislot class is given then  $Rx$  and  $Tx$  of the signalled multislot class shall apply.
- If an Alternative EFTA multislot class is given then  $Tx$  of the signalled multislot class shall apply whereas  $Rx$  of the Alternative EFTA multislot class shall apply.

The multislot capability parameters  $Sum$ ,  $T_{ta}$ ,  $T_{tb}$ ,  $T_{ra}$  and  $T_{rb}$  shall be derived as follows:



- If an Alternative EFTA multislot class is given and the mobile station is assigned a multislot configuration comprising a number of downlink timeslots higher than the Rx value corresponding to the signalled multislot class and the mobile station is not transmitting in a given radio block period, then  $T_{rb}$  and  $T_{ra}$  as given in Table B.3 shall apply for the considered radio block period. Sum,  $T_{ta}$  and  $T_{tb}$  are not applicable during the considered radio block period.
- In all other cases, Sum,  $T_{ta}$ ,  $T_{tb}$ ,  $T_{ra}$  and  $T_{rb}$  of the signalled multislot class shall apply.

Only mobile stations with (DTM) EGPRS high multislot classes 30-45 can support EFTA.

**Table B.3**

Alternative EFTA multislot class	Rx	$T_{ra}$	$T_{rb}$ (NOTE 2)
Alternative EFTA multislot class 1	6	1	c)
Alternative EFTA multislot class 2	7	1	c)
Alternative EFTA multislot class 3	8	1 (NOTE 1)	d)

NOTE 1:  $T_{ra}$  not applicable for multislot configurations with  $d=8$  timeslots.  
NOTE 2: c) and d) are as defined in subclause B.1.

Whether normal measurements (see 3GPP TS 45.008) and/or normal BSIC decoding (see 3GPP TS 45.008) are possible will be dependent on the allocation or on the use of a second receiver for this purpose.

The multislot capability parameters applicable to EFTA operation in a downlink dual carrier configuration are in addition dependent on the *EFTA Multislot Capability Reduction for Downlink Dual Carrier* field (see subclause B.4).

## B.6 Multislot capabilities for Downlink Multi Carrier mobile stations

For mobile stations supporting DLMC configurations (see 3GPP TS 44.060), the multislot capability applicable to DLMC operation is dependent on the EGPRS (high) multislot class (see subclause B.1), on the *Maximum number of downlink timeslots* field (see 3GPP TS 24.008) and, if provided, on the *Alternative EFTA multislot class* field (see subclause B.5) as signalled by the mobile station as defined in Table B.2. Only mobile stations of multislot classes listed in Table B.2 can support DLMC. The equivalent multislot class does not apply for a mobile station supporting DLMC.

The values of  $Rx'$  and  $Tx'$  as defined in subclause B.4 apply for DLMC configurations.

The values of  $Sum''$  and  $Rx\_Sum''$  apply for downlink DLMC configurations as defined below.

If the MS has not indicated support for Enhanced Flexible Timeslot Assignment (see 3GPP TS 24.008), then  $Rx'$ ,  $Tx'$  and  $Sum''$  correspond to  $Rx$ ,  $Tx$  and  $Sum$  for the signalled multislot class and the switching times  $T_{ta}$ ,  $T_{tb}$ ,  $T_{ra}$  and  $T_{rb}$  of the signalled multislot class shall apply.

If the MS has indicated support for Enhanced Flexible Timeslot Assignment (see 3GPP TS 24.008), then  $Rx'$ ,  $Tx'$  and  $Sum''$ ,  $T_{ta}$ ,  $T_{tb}$ ,  $T_{ra}$  and  $T_{rb}$  all correspond to  $Rx$ ,  $Tx$ ,  $Sum$ ,  $T_{ta}$ ,  $T_{tb}$ ,  $T_{ra}$  and  $T_{rb}$  respectively as defined in subclause B.5.  $Rx\_Sum'$  is given by the *Maximum Number of downlink timeslots* indicated by the MS (see 3GPP TS 24.008) and applies irrespective of whether EFTA operation is used or not.

### Sum'':

$Sum''$  is the total number of uplink TS and downlink TS (on either radio frequency channel) that can be used by the MS per TDMA frame. The MS must be able to support all combinations of integer values of  $1 \leq dX \leq Rx'$ , and  $u \leq Tx'$  TS where  $1 \leq dX + u \leq Sum'$  (depending on the services supported by the MS).  $dX$  can be either of  $[d1, d2, \dots, d15, d16]$  depending on the maximum number of carriers supported by the MS, see 3GPP TS 24.008.

### Rx\_Sum':

$Rx\_Sum'$  is the total number of downlink TS (assigned across, at most, the maximum number of carriers,  $C_{max}$ , supported by the mobile, see 3GPP TS 24.008), that can be received by the MS per TDMA frame. The MS must be able to support all combinations of integer values of  $dX$  where  $1 \leq \sum_{X=1}^{C_{max}} dX \leq Rx\_Sum'$  (depending on the services supported by the MS).

## Annex C (informative): CTSBCH Timeslot shifting example

With the following parameters :

- $TNI = 4$
- $TNSCN = 9$
- $TNSCO = 1$  i.e.  $(TNS1 = TNS_{9,1} = (0, 3, 7, 6, 5, 2, 4, 1))$  and  $TNS2 = TNS_{9,0} = (0, 1, 4, 5, 7, 3, 6, 2)$
- $x0 = 2$
- $x1 = 3$
- $x2 = 5$
- $x3 = 4$

and the timeslot shifting algorithm defined in section 6.3.3, the CTSBCH TN used in set 0 of the shifting sequence is :

(FN div 52) mod 51	0	1	2	3	4	5	6	7	8	9	10	11	12	13	14	15	16	17
TNS used	1	1	1	1	1	1	1	1	2	2	2	2	1	1	1	1	1	2
CTSBCH TN	4	1	0	3	7	6	5	2	0	1	4	5	2	4	1	0	3	6
(FN div 52) mod 51	18	19	20	21	22	23	24	25	26	27	28	29	30	31	32	33	34	35
TNS used	2	2	1	1	2	2	2	2	2	2	2	2	1	1	1	1	1	1
CTSBCH TN	2	0	3	7	3	6	2	0	1	4	5	7	6	5	2	4	1	0
(FN div 52) mod 51	36	37	38	39	40	41	42	43	44	45	46	47	48	49	50			
TNS used	2	2	2	2	2	1	1	1	2	2	2	2	1	1	1			
CTSBCH TN	1	4	5	7	3	7	6	5	7	3	6	2	4	1	0			

For the next sets, same mechanism applies, with

- set 1 beginning with CTSBCH TN = 3
- set 2 beginning with CTSBCH TN = 5
- set 3 beginning with CTSBCH TN = 1
- set 4 beginning with CTSBCH TN = 7
- set 5 beginning with CTSBCH TN = 2
- set 6 beginning with CTSBCH TN = 0
- set 7 beginning with CTSBCH TN = 6

---

## Annex D (informative): COMPACT multiframe structure examples

In the figures, the 52-multiframe number (MFN) shall have a range of 0 to 3 and can be calculated from the TDMA frame number (FN) as follows:

$$\text{MFN} = (\text{FN div } 52) \bmod 4$$

For COMPACT, timeslot mapping and rotation of the control channels is used such that control channels belonging to a serving time group are rotated over odd timeslot numbers as follows: 7, 5, 3, 1, 7, 5, ... . The rotation occurs between frame numbers  $(\text{FN}) \bmod 52 = 3$  and 4. The timeslot mapping and rotation of the control channels in this manner allows the mobile station to measure the received signal level from surrounding cells in its normal measurement window. Since the rotation repeats itself every 208 frames, the 52-multiframe number (MFN) allows the mobile station to determine its location in the time group rotation during selection and re-selection.

The following relates to Figures D.1 through D.7:

- i)  $B(x)^y$  = time group y uses CPBCCH in block x;
- ii)  $C(x)^y$  = time group y uses CPCCCH in block x;
- iii) PTCCH = PTCCH as normal;
- iv)  $\text{CFCCH}^y$  = time group y uses CFCCH;
- v)  $\text{CSCH}^y$  = time group y uses CSCH;
- vi) IDLE = idle burst;
- vii)  $X^y$  = block designated as idle for time group y;
- viii) Empty = used for traffic as normal.

Frames 0-51 of a 208-multiframe MFN = 0 TG = 0								Frames 0-51 of a 208-multiframe MFN = 0 TG = 1								Frames 0-51 of a 208-multiframe MFN = 0 TG = 2								Frames 0-51 of a 208-multiframe MFN = 0 TG = 3											
TS	0	1	2	3	4	5	6	7	TS	0	1	2	3	4	5	6	7	TS	0	1	2	3	4	5	6	7	TS	0	1	2	3	4	5	6	7
FN									FN									FN									FN								
0	B(0) <sup>0</sup>	X <sup>1</sup>	X <sup>2</sup>	X <sup>3</sup>					0	X <sup>0</sup>	B(0) <sup>1</sup>	X <sup>2</sup>	X <sup>3</sup>					0	X <sup>0</sup>	X <sup>1</sup>	B(0) <sup>2</sup>	X <sup>3</sup>					0	X <sup>0</sup>	X <sup>1</sup>	X <sup>2</sup>	B(0) <sup>3</sup>	X <sup>3</sup>			
1	B(0) <sup>0</sup>	X <sup>1</sup>	X <sup>2</sup>	X <sup>3</sup>					1	X <sup>0</sup>	B(0) <sup>1</sup>	X <sup>2</sup>	X <sup>3</sup>					1	X <sup>0</sup>	X <sup>1</sup>	B(0) <sup>2</sup>	X <sup>3</sup>					1	X <sup>0</sup>	X <sup>1</sup>	X <sup>2</sup>	B(0) <sup>3</sup>	X <sup>3</sup>			
2	B(0) <sup>0</sup>	X <sup>1</sup>	X <sup>2</sup>	X <sup>3</sup>					2	X <sup>0</sup>	B(0) <sup>1</sup>	X <sup>2</sup>	X <sup>3</sup>					2	X <sup>0</sup>	X <sup>1</sup>	B(0) <sup>2</sup>	X <sup>3</sup>					2	X <sup>0</sup>	X <sup>1</sup>	X <sup>2</sup>	B(0) <sup>3</sup>	X <sup>3</sup>			
3	B(0) <sup>0</sup>	X <sup>1</sup>	X <sup>2</sup>	X <sup>3</sup>					3	X <sup>0</sup>	B(0) <sup>1</sup>	X <sup>2</sup>	X <sup>3</sup>					3	X <sup>0</sup>	X <sup>1</sup>	B(0) <sup>2</sup>	X <sup>3</sup>					3	X <sup>0</sup>	X <sup>1</sup>	X <sup>2</sup>	B(0) <sup>3</sup>	X <sup>3</sup>			
4									4									4									4								
5									5									5									5								
6									6									6									6								
7									7									7									7								
8									8									8									8								
9									9									9									9								
10									10									10									10								
11									11									11									11								
12	PTCCH								12	PTCCH								12	PTCCH								12	PTCCH							
13	X <sup>1</sup>	X <sup>2</sup>	X <sup>3</sup>	C(3) <sup>0</sup>					13	C(3) <sup>1</sup>	X <sup>2</sup>	X <sup>3</sup>	X <sup>0</sup>					13	X <sup>1</sup>	C(3) <sup>2</sup>	X <sup>3</sup>	X <sup>0</sup>					13	X <sup>1</sup>	X <sup>2</sup>	C(3) <sup>3</sup>	X <sup>0</sup>				
14	X <sup>1</sup>	X <sup>2</sup>	X <sup>3</sup>	C(3) <sup>0</sup>					14	C(3) <sup>1</sup>	X <sup>2</sup>	X <sup>3</sup>	X <sup>0</sup>					14	X <sup>1</sup>	C(3) <sup>2</sup>	X <sup>3</sup>	X <sup>0</sup>					14	X <sup>1</sup>	X <sup>2</sup>	C(3) <sup>3</sup>	X <sup>0</sup>				
15	X <sup>1</sup>	X <sup>2</sup>	X <sup>3</sup>	C(3) <sup>0</sup>					15	C(3) <sup>1</sup>	X <sup>2</sup>	X <sup>3</sup>	X <sup>0</sup>					15	X <sup>1</sup>	C(3) <sup>2</sup>	X <sup>3</sup>	X <sup>0</sup>					15	X <sup>1</sup>	X <sup>2</sup>	C(3) <sup>3</sup>	X <sup>0</sup>				
16	X <sup>1</sup>	X <sup>2</sup>	X <sup>3</sup>	C(3) <sup>0</sup>					16	C(3) <sup>1</sup>	X <sup>2</sup>	X <sup>3</sup>	X <sup>0</sup>					16	X <sup>1</sup>	C(3) <sup>2</sup>	X <sup>3</sup>	X <sup>0</sup>					16	X <sup>1</sup>	X <sup>2</sup>	C(3) <sup>3</sup>	X <sup>0</sup>				
17									17									17									17								
18									18									18									18								
19									19									19									19								
20									20									20									20								
21									21									21									21								
22									22									22									22								
23									23									23									23								
24									24									24									24								
25	IDLE			CFCCH <sup>0</sup>					25	ID	CFCCH <sup>1</sup>	IDLE					25	IDLE	CFCCH <sup>2</sup>	IDLE					25	IDLE		CFCCH <sup>3</sup>	IDLE						
26	X <sup>1</sup>	X <sup>2</sup>	X <sup>3</sup>	C(6) <sup>0</sup>					26	C(6) <sup>1</sup>	X <sup>2</sup>	X <sup>3</sup>	X <sup>0</sup>					26	X <sup>1</sup>	C(6) <sup>2</sup>	X <sup>3</sup>	X <sup>0</sup>					26	X <sup>1</sup>	X <sup>2</sup>	C(6) <sup>3</sup>	X <sup>0</sup>				
27	X <sup>1</sup>	X <sup>2</sup>	X <sup>3</sup>	C(6) <sup>0</sup>					27	C(6) <sup>1</sup>	X <sup>2</sup>	X <sup>3</sup>	X <sup>0</sup>					27	X <sup>1</sup>	C(6) <sup>2</sup>	X <sup>3</sup>	X <sup>0</sup>					27	X <sup>1</sup>	X <sup>2</sup>	C(6) <sup>3</sup>	X <sup>0</sup>				
28	X <sup>1</sup>	X <sup>2</sup>	X <sup>3</sup>	C(6) <sup>0</sup>					28	C(6) <sup>1</sup>	X <sup>2</sup>	X <sup>3</sup>	X <sup>0</sup>					28	X <sup>1</sup>	C(6) <sup>2</sup>	X <sup>3</sup>	X <sup>0</sup>					28	X <sup>1</sup>	X <sup>2</sup>	C(6) <sup>3</sup>	X <sup>0</sup>				
29	X <sup>1</sup>	X <sup>2</sup>	X <sup>3</sup>	C(6) <sup>0</sup>					29	C(6) <sup>1</sup>	X <sup>2</sup>	X <sup>3</sup>	X <sup>0</sup>					29	X <sup>1</sup>	C(6) <sup>2</sup>	X <sup>3</sup>	X <sup>0</sup>					29	X <sup>1</sup>	X <sup>2</sup>	C(6) <sup>3</sup>	X <sup>0</sup>				
30									30									30									30								
31									31									31									31								
32									32									32									32								
33									33									33									33								
34									34									34									34								
35									35									35									35								
36									36									36									36								
37									37									37									37								
38	PTCCH								38	PTCCH								38	PTCCH								38	PTCCH							
39	X <sup>1</sup>	X <sup>2</sup>	X <sup>3</sup>	C(9) <sup>0</sup>					39	C(9) <sup>1</sup>	X <sup>2</sup>	X <sup>3</sup>	X <sup>0</sup>					39	X <sup>1</sup>	C(9) <sup>2</sup>	X <sup>3</sup>	X <sup>0</sup>					39	X <sup>1</sup>	X <sup>2</sup>	C(9) <sup>3</sup>	X <sup>0</sup>				
40	X <sup>1</sup>	X <sup>2</sup>	X <sup>3</sup>	C(9) <sup>0</sup>					40	C(9) <sup>1</sup>	X <sup>2</sup>	X <sup>3</sup>	X <sup>0</sup>					40	X <sup>1</sup>	C(9) <sup>2</sup>	X <sup>3</sup>	X <sup>0</sup>					40	X <sup>1</sup>	X <sup>2</sup>	C(9) <sup>3</sup>	X <sup>0</sup>				
41	X <sup>1</sup>	X <sup>2</sup>	X <sup>3</sup>	C(9) <sup>0</sup>					41	C(9) <sup>1</sup>	X <sup>2</sup>	X <sup>3</sup>	X <sup>0</sup>					41	X <sup>1</sup>	C(9) <sup>2</sup>	X <sup>3</sup>	X <sup>0</sup>					41	X <sup>1</sup>	X <sup>2</sup>	C(9) <sup>3</sup>	X <sup>0</sup>				
42	X <sup>1</sup>	X <sup>2</sup>	X <sup>3</sup>	C(9) <sup>0</sup>					42	C(9) <sup>1</sup>	X <sup>2</sup>	X <sup>3</sup>	X <sup>0</sup>					42	X <sup>1</sup>	C(9) <sup>2</sup>	X <sup>3</sup>	X <sup>0</sup>					42	X <sup>1</sup>	X <sup>2</sup>	C(9) <sup>3</sup>	X <sup>0</sup>				
43									43									43									43								
44									44									44									44								
45									45									45									45								
46									46									46									46								
47									47									47									47								
48									48									48									48								
49									49									49									49								
50									50									50									50								
51	IDLE			CSCH <sup>0</sup>					51	ID	CSCH <sup>1</sup>	IDLE					51	IDLE	CSCH <sup>2</sup>	IDLE					51	IDLE		CSCH <sup>3</sup>	IDLE						

Figure D.1: COMPACT downlink 52-multiframe structure using 4 time groups for nominal cells (based on an assignment of 1 CPBCH and 3 CPCCCHs with NIB\_CCCH\_0 = NIB\_CCCH\_1 = NIB\_CCCH\_2 = NIB\_CCCH\_3 = 4). NIB\_CCCH is not broadcast for serving cell time group

NOTE: For uplink 52-multiframe structure (based on an assignment of 16 prioritized CPRACHs, see subclause 6.3.2.2.3a), replace B( ) by R( ) where R( ) denotes CPRACH, move down one block, and rotate according to subclause 6.3.2.1. Replace C( ) by R( ) and move down one block. CPRACH in general can be mapped as PRACH in table 6 of clause 7.

Frames 0-51 of a 208-multiframe								Frames 0-51 of a 208-multiframe								Frames 0-51 of a 208-multiframe										
MFN = 0								MFN = 0								MFN = 0										
TG = 0								TG = 1								TG = 2										
TS	0	1	2	3	4	5	6	7	TS	0	1	2	3	4	5	6	7	TS	0	1	2	3	4	5	6	7
FN									FN									FN								
0	B(0) <sup>0</sup>	X <sup>1</sup>	X <sup>2</sup>						0	X <sup>0</sup>	B(0) <sup>1</sup>	X <sup>2</sup>						0	X <sup>0</sup>	X <sup>1</sup>	B(0) <sup>2</sup>					
1	B(0) <sup>0</sup>	X <sup>1</sup>	X <sup>2</sup>						1	X <sup>0</sup>	B(0) <sup>1</sup>	X <sup>2</sup>						1	X <sup>0</sup>	X <sup>1</sup>	B(0) <sup>2</sup>					
2	B(0) <sup>0</sup>	X <sup>1</sup>	X <sup>2</sup>						2	X <sup>0</sup>	B(0) <sup>1</sup>	X <sup>2</sup>						2	X <sup>0</sup>	X <sup>1</sup>	B(0) <sup>2</sup>					
3	B(0) <sup>0</sup>	X <sup>1</sup>	X <sup>2</sup>						3	X <sup>0</sup>	B(0) <sup>1</sup>	X <sup>2</sup>						3	X <sup>0</sup>	X <sup>1</sup>	B(0) <sup>2</sup>					
4									4									4								
5									5									5								
6									6									6								
7									7									7								
8									8									8								
9									9									9								
10									10									10								
11									11									11								
12	PTCCH								12	PTCCH								12	PTCCH							
13	X <sup>1</sup>	X <sup>2</sup>					C(3) <sup>0</sup>	13	C(3) <sup>1</sup>	X <sup>2</sup>				X <sup>0</sup>	13	X <sup>1</sup>	C(3) <sup>2</sup>			X <sup>0</sup>						
14	X <sup>1</sup>	X <sup>2</sup>					C(3) <sup>0</sup>	14	C(3) <sup>1</sup>	X <sup>2</sup>				X <sup>0</sup>	14	X <sup>1</sup>	C(3) <sup>2</sup>			X <sup>0</sup>						
15	X <sup>1</sup>	X <sup>2</sup>					C(3) <sup>0</sup>	15	C(3) <sup>1</sup>	X <sup>2</sup>				X <sup>0</sup>	15	X <sup>1</sup>	C(3) <sup>2</sup>			X <sup>0</sup>						
16	X <sup>1</sup>	X <sup>2</sup>					C(3) <sup>0</sup>	16	C(3) <sup>1</sup>	X <sup>2</sup>				X <sup>0</sup>	16	X <sup>1</sup>	C(3) <sup>2</sup>			X <sup>0</sup>						
17								17							17											
18								18							18											
19								19							19											
20								20							20											
21								21							21											
22								22							22											
23								23							23											
24								24							24											
25	IDLE						CFCCH <sup>0</sup>	25	ID	CFCCH <sup>1</sup>	IDLE				25	IDLE	CFCCH <sup>2</sup>	IDLE								
26	X <sup>1</sup>	X <sup>2</sup>					C(6) <sup>0</sup>	26	C(6) <sup>1</sup>	X <sup>2</sup>				X <sup>0</sup>	26	X <sup>1</sup>	C(6) <sup>2</sup>			X <sup>0</sup>						
27	X <sup>1</sup>	X <sup>2</sup>					C(6) <sup>0</sup>	27	C(6) <sup>1</sup>	X <sup>2</sup>				X <sup>0</sup>	27	X <sup>1</sup>	C(6) <sup>2</sup>			X <sup>0</sup>						
28	X <sup>1</sup>	X <sup>2</sup>					C(6) <sup>0</sup>	28	C(6) <sup>1</sup>	X <sup>2</sup>				X <sup>0</sup>	28	X <sup>1</sup>	C(6) <sup>2</sup>			X <sup>0</sup>						
29	X <sup>1</sup>	X <sup>2</sup>					C(6) <sup>0</sup>	29	C(6) <sup>1</sup>	X <sup>2</sup>				X <sup>0</sup>	29	X <sup>1</sup>	C(6) <sup>2</sup>			X <sup>0</sup>						
30								30							30											
31								31							31											
32								32							32											
33								33							33											
34								34							34											
35								35							35											
36								36							36											
37								37							37											
38	PTCCH								38	PTCCH								38	PTCCH							
39	X <sup>1</sup>	X <sup>2</sup>					C(9) <sup>0</sup>	39	C(9) <sup>1</sup>	X <sup>2</sup>				X <sup>0</sup>	39	X <sup>1</sup>	C(9) <sup>2</sup>			X <sup>0</sup>						
40	X <sup>1</sup>	X <sup>2</sup>					C(9) <sup>0</sup>	40	C(9) <sup>1</sup>	X <sup>2</sup>				X <sup>0</sup>	40	X <sup>1</sup>	C(9) <sup>2</sup>			X <sup>0</sup>						
41	X <sup>1</sup>	X <sup>2</sup>					C(9) <sup>0</sup>	41	C(9) <sup>1</sup>	X <sup>2</sup>				X <sup>0</sup>	41	X <sup>1</sup>	C(9) <sup>2</sup>			X <sup>0</sup>						
42	X <sup>1</sup>	X <sup>2</sup>					C(9) <sup>0</sup>	42	C(9) <sup>1</sup>	X <sup>2</sup>				X <sup>0</sup>	42	X <sup>1</sup>	C(9) <sup>2</sup>			X <sup>0</sup>						
43								43							43											
44								44							44											
45								45							45											
46								46							46											
47								47							47											
48								48							48											
49								49							49											
50								50							50											
51	IDLE						CSCH <sup>0</sup>	51	ID	CSCH <sup>1</sup>	IDLE				51	IDLE	CSCH <sup>2</sup>	IDLE								

Figure D.2: COMPACT downlink 52-multiframe structure using 3 time groups for nominal cells (based on an assignment of 1 CPBCH and 3 CPCCCHs with NIB\_CCCH\_0 = NIB\_CCCH\_1 = NIB\_CCCH\_2 = 4, NIB\_CCCH\_3 = 0). NIB\_CCCHs not broadcast for serving cell time group

NOTE: For uplink 52-multiframe structure (based on an assignment of 16 prioritized CPRACHs, see subclause 6.3.2.2.3a), replace B( ) by R( ) where R( ) denotes CPRACH, move down one block, and rotate according to subclause 6.3.2.1. Replace C( ) by R( ) and move down one block. CPRACH in general can be mapped as PRACH in table 6 of clause 7.



Frames 0-51 of a 208-multiframe								
MFN = 0								
TG = 0								
TS	0	1	2	3	4	5	6	
FN	0	1	2	3	4	5	6	
0		B(0) <sup>0</sup>	X <sup>1</sup>	X <sup>1</sup>	X <sup>12</sup>	X <sup>2</sup>	X <sup>2</sup>	
1		B(0) <sup>0</sup>	X <sup>1</sup>	X <sup>1</sup>	X <sup>12</sup>	X <sup>2</sup>	X <sup>2</sup>	
2		B(0) <sup>0</sup>	X <sup>1</sup>	X <sup>1</sup>	X <sup>12</sup>	X <sup>2</sup>	X <sup>2</sup>	
3		B(0) <sup>0</sup>	X <sup>1</sup>	X <sup>1</sup>	X <sup>12</sup>	X <sup>2</sup>	X <sup>2</sup>	
4								
5								
6								
7								
8								
9								
10								
11								
12		PTCCH						
13	X <sup>1</sup>	X <sup>1</sup>	X <sup>12</sup>	X <sup>2</sup>	X <sup>2</sup>		C(3) <sup>0</sup>	
14	X <sup>1</sup>	X <sup>1</sup>	X <sup>12</sup>	X <sup>2</sup>	X <sup>2</sup>		C(3) <sup>0</sup>	
15	X <sup>1</sup>	X <sup>1</sup>	X <sup>12</sup>	X <sup>2</sup>	X <sup>2</sup>		C(3) <sup>0</sup>	
16	X <sup>1</sup>	X <sup>1</sup>	X <sup>12</sup>	X <sup>2</sup>	X <sup>2</sup>		C(3) <sup>0</sup>	
17								
18								
19								
20								
21								
22								
23								
24								
25		IDLE					CFCCH <sup>0</sup>	
26	X <sup>1</sup>	X <sup>1</sup>	X <sup>12</sup>	X <sup>2</sup>	X <sup>2</sup>		C(6) <sup>0</sup>	
27	X <sup>1</sup>	X <sup>1</sup>	X <sup>12</sup>	X <sup>2</sup>	X <sup>2</sup>		C(6) <sup>0</sup>	
28	X <sup>1</sup>	X <sup>1</sup>	X <sup>12</sup>	X <sup>2</sup>	X <sup>2</sup>		C(6) <sup>0</sup>	
29	X <sup>1</sup>	X <sup>1</sup>	X <sup>12</sup>	X <sup>2</sup>	X <sup>2</sup>		C(6) <sup>0</sup>	
30								
31								
32								
33								
34								
35								
36								
37								
38		PTCCH						
39	X <sup>1</sup>	X <sup>1</sup>	X <sup>12</sup>	X <sup>2</sup>	X <sup>2</sup>		C(9) <sup>0</sup>	
40	X <sup>1</sup>	X <sup>1</sup>	X <sup>12</sup>	X <sup>2</sup>	X <sup>2</sup>		C(9) <sup>0</sup>	
41	X <sup>1</sup>	X <sup>1</sup>	X <sup>12</sup>	X <sup>2</sup>	X <sup>2</sup>		C(9) <sup>0</sup>	
42	X <sup>1</sup>	X <sup>1</sup>	X <sup>12</sup>	X <sup>2</sup>	X <sup>2</sup>		C(9) <sup>0</sup>	
43								
44								
45								
46								
47								
48								
49								
50								
51		IDLE					CSCH <sup>0</sup>	

Frames 0-51 of a 208-multiframe								
MFN = 0								
TG = 1								
TS	0	1	2	3	4	5	6	
FN	0	1	2	3	4	5	6	
0	X <sup>0</sup>	X <sup>0</sup>	X <sup>0</sup>	B(0) <sup>1</sup>	X <sup>2</sup>	X <sup>2</sup>	X <sup>2</sup>	
1	X <sup>0</sup>	X <sup>0</sup>	X <sup>0</sup>	B(0) <sup>1</sup>	X <sup>2</sup>	X <sup>2</sup>	X <sup>2</sup>	
2	X <sup>0</sup>	X <sup>0</sup>	X <sup>0</sup>	B(0) <sup>1</sup>	X <sup>2</sup>	X <sup>2</sup>	X <sup>2</sup>	
3	X <sup>0</sup>	X <sup>0</sup>	X <sup>0</sup>	B(0) <sup>1</sup>	X <sup>2</sup>	X <sup>2</sup>	X <sup>2</sup>	
4								
5								
6								
7								
8								
9								
10								
11								
12		PTCCH						
13	X <sup>0</sup>	C(3) <sup>1</sup>	X <sup>2</sup>	X <sup>2</sup>	X <sup>2</sup>	X <sup>0</sup>	X <sup>0</sup>	
14	X <sup>0</sup>	C(3) <sup>1</sup>	X <sup>2</sup>	X <sup>2</sup>	X <sup>2</sup>	X <sup>0</sup>	X <sup>0</sup>	
15	X <sup>0</sup>	C(3) <sup>1</sup>	X <sup>2</sup>	X <sup>2</sup>	X <sup>2</sup>	X <sup>0</sup>	X <sup>0</sup>	
16	X <sup>0</sup>	C(3) <sup>1</sup>	X <sup>2</sup>	X <sup>2</sup>	X <sup>2</sup>	X <sup>0</sup>	X <sup>0</sup>	
17								
18								
19								
20								
21								
22								
23								
24								
25	ID	CFCCH <sup>1</sup>	IDLE					
26	X <sup>0</sup>	C(6) <sup>1</sup>	X <sup>2</sup>	X <sup>2</sup>	X <sup>2</sup>	X <sup>0</sup>	X <sup>0</sup>	
27	X <sup>0</sup>	C(6) <sup>1</sup>	X <sup>2</sup>	X <sup>2</sup>	X <sup>2</sup>	X <sup>0</sup>	X <sup>0</sup>	
28	X <sup>0</sup>	C(6) <sup>1</sup>	X <sup>2</sup>	X <sup>2</sup>	X <sup>2</sup>	X <sup>0</sup>	X <sup>0</sup>	
29	X <sup>0</sup>	C(6) <sup>1</sup>	X <sup>2</sup>	X <sup>2</sup>	X <sup>2</sup>	X <sup>0</sup>	X <sup>0</sup>	
30								
31								
32								
33								
34								
35								
36								
37								
38		PTCCH						
39	X <sup>0</sup>	C(9) <sup>1</sup>	X <sup>2</sup>	X <sup>2</sup>	X <sup>2</sup>	X <sup>0</sup>	X <sup>0</sup>	
40	X <sup>0</sup>	C(9) <sup>1</sup>	X <sup>2</sup>	X <sup>2</sup>	X <sup>2</sup>	X <sup>0</sup>	X <sup>0</sup>	
41	X <sup>0</sup>	C(9) <sup>1</sup>	X <sup>2</sup>	X <sup>2</sup>	X <sup>2</sup>	X <sup>0</sup>	X <sup>0</sup>	
42	X <sup>0</sup>	C(9) <sup>1</sup>	X <sup>2</sup>	X <sup>2</sup>	X <sup>2</sup>	X <sup>0</sup>	X <sup>0</sup>	
43								
44								
45								
46								
47								
48								
49								
50								
51	ID	CSCH <sup>1</sup>	IDLE					

Frames 0-51 of a 208-multiframe								
MFN = 0								
TG = 2								
TS	0	1	2	3	4	5	6	
FN	0	1	2	3	4	5	6	
0	X <sup>0</sup>	X <sup>0</sup>	X <sup>01</sup>	X <sup>1</sup>	X <sup>1</sup>	B(0) <sup>2</sup>		
1	X <sup>0</sup>	X <sup>0</sup>	X <sup>01</sup>	X <sup>1</sup>	X <sup>1</sup>	B(0) <sup>2</sup>		
2	X <sup>0</sup>	X <sup>0</sup>	X <sup>01</sup>	X <sup>1</sup>	X <sup>1</sup>	B(0) <sup>2</sup>		
3	X <sup>0</sup>	X <sup>0</sup>	X <sup>01</sup>	X <sup>1</sup>	X <sup>1</sup>	B(0) <sup>2</sup>		
4								
5								
6								
7								
8								
9								
10								
11								
12		PTCCH						
13	X <sup>01</sup>	X <sup>1</sup>	X <sup>1</sup>	C(3) <sup>2</sup>		X <sup>0</sup>	X <sup>0</sup>	
14	X <sup>01</sup>	X <sup>1</sup>	X <sup>1</sup>	C(3) <sup>2</sup>		X <sup>0</sup>	X <sup>0</sup>	
15	X <sup>01</sup>	X <sup>1</sup>	X <sup>1</sup>	C(3) <sup>2</sup>		X <sup>0</sup>	X <sup>0</sup>	
16	X <sup>01</sup>	X <sup>1</sup>	X <sup>1</sup>	C(3) <sup>2</sup>		X <sup>0</sup>	X <sup>0</sup>	
17								
18								
19								
20								
21								
22								
23								
24								
25	IDLE	CFCCH <sup>2</sup>	IDLE					
26	X <sup>01</sup>	X <sup>1</sup>	X <sup>1</sup>	C(6) <sup>2</sup>		X <sup>0</sup>	X <sup>0</sup>	
27	X <sup>01</sup>	X <sup>1</sup>	X <sup>1</sup>	C(6) <sup>2</sup>		X <sup>0</sup>	X <sup>0</sup>	
28	X <sup>01</sup>	X <sup>1</sup>	X <sup>1</sup>	C(6) <sup>2</sup>		X <sup>0</sup>	X <sup>0</sup>	
29	X <sup>01</sup>	X <sup>1</sup>	X <sup>1</sup>	C(6) <sup>2</sup>		X <sup>0</sup>	X <sup>0</sup>	
30								
31								
32								
33								
34								
35								
36								
37								
38		PTCCH						
39	X <sup>01</sup>	X <sup>1</sup>	X <sup>1</sup>	C(9) <sup>2</sup>		X <sup>0</sup>	X <sup>0</sup>	
40	X <sup>01</sup>	X <sup>1</sup>	X <sup>1</sup>	C(9) <sup>2</sup>		X <sup>0</sup>	X <sup>0</sup>	
41	X <sup>01</sup>	X <sup>1</sup>	X <sup>1</sup>	C(9) <sup>2</sup>		X <sup>0</sup>	X <sup>0</sup>	
42	X <sup>01</sup>	X <sup>1</sup>	X <sup>1</sup>	C(9) <sup>2</sup>		X <sup>0</sup>	X <sup>0</sup>	
43								
44								
45								
46								
47								
48								
49								
50								
51	IDLE	CSCH <sup>2</sup>	IDLE					

Figure D.4: COMPACT downlink 52-multiframe structure using 3 time groups for large cells (based on an assignment of 1 CPBCH and 3 CPCCCHs with NIB\_CCCH\_0 = NIB\_CCCH\_1 = NIB\_CCCH\_2 = 4, NIB\_CCCH\_3 = 0). NIB\_CCCH is not broadcast for serving cell time group

NOTE: For uplink 52-multiframe structure (based on an assignment of 16 prioritized CPRACHs, see subclause 6.3.2.2.3a), replace B( ) by R( ) where R( ) denotes CPRACH, move down one block, and rotate according to subclause 6.3.2.1. Replace C( ) by R( ) and move down one block. CPRACH in general can be mapped as PRACH in table 6 of clause 7.

Frames 0-51 of a 208-multiframe MFN = 0								Frames 52-103 of a 208-multiframe MFN = 1								Frames 104-155 of a 208-multiframe MFN = 2								Frames 156-207 of a 208-multiframe MFN = 3											
TS	0	1	2	3	4	5	6	7	TS	0	1	2	3	4	5	6	7	TS	0	1	2	3	4	5	6	7	TS	0	1	2	3	4	5	6	7
FN									FN									FN									FN								
0	B(0) <sup>0</sup>	X <sup>1</sup>	X <sup>2</sup>	X <sup>3</sup>					52	X <sup>1</sup>	X <sup>2</sup>	X <sup>3</sup>				B(0) <sup>0</sup>		104	X <sup>2</sup>	X <sup>3</sup>	B(0) <sup>0</sup>	X <sup>1</sup>					156	X <sup>3</sup>	B(0) <sup>0</sup>	X <sup>1</sup>	X <sup>2</sup>				
1	B(0) <sup>0</sup>	X <sup>1</sup>	X <sup>2</sup>	X <sup>3</sup>					53	X <sup>1</sup>	X <sup>2</sup>	X <sup>3</sup>				B(0) <sup>0</sup>		105	X <sup>2</sup>	X <sup>3</sup>	B(0) <sup>0</sup>	X <sup>1</sup>					157	X <sup>3</sup>	B(0) <sup>0</sup>	X <sup>1</sup>	X <sup>2</sup>				
2	B(0) <sup>0</sup>	X <sup>1</sup>	X <sup>2</sup>	X <sup>3</sup>					54	X <sup>1</sup>	X <sup>2</sup>	X <sup>3</sup>				B(0) <sup>0</sup>		106	X <sup>2</sup>	X <sup>3</sup>	B(0) <sup>0</sup>	X <sup>1</sup>					158	X <sup>3</sup>	B(0) <sup>0</sup>	X <sup>1</sup>	X <sup>2</sup>				
3	B(0) <sup>0</sup>	X <sup>1</sup>	X <sup>2</sup>	X <sup>3</sup>					55	X <sup>1</sup>	X <sup>2</sup>	X <sup>3</sup>				B(0) <sup>0</sup>		107	X <sup>2</sup>	X <sup>3</sup>	B(0) <sup>0</sup>	X <sup>1</sup>					159	X <sup>3</sup>	B(0) <sup>0</sup>	X <sup>1</sup>	X <sup>2</sup>				
4									56									108									160								
5									57									109									161								
6									58									110									162								
7									59									111									163								
8									60									112									164								
9									61									113									165								
10									62									114									166								
11									63									115									167								
12									64									116									168								
13									65									117									169								
14									66									118									170								
15									67									119									171								
16									68									120									172								
17									69									121									173								
18									70									122									174								
19									71									123									175								
20									72									124									176								
21									73									125									177								
22									74									126									178								
23									75									127									179								
24									76									128									180								
25									77									129									181								
26									78									130									182								
27									79									131									183								
28									80									132									184								
29									81									133									185								
30									82									134									186								
31									83									135									187								
32									84									136									188								
33									85									137									189								
34									86									138									190								
35									87									139									191								
36									88									140									192								
37									89									141									193								
38									90									142									194								
39									91									143									195								
40									92									144									196								
41									93									145									197								
42									94									146									198								
43									95									147									199								
44									96									148									200								
45									97									149									201								
46									98									150									202								
47									99									151									203								
48									100									152									204								
49									101									153									205								
50									102									154									206								
51									103									155									207								

Figure D.5: Example of COMPACT downlink timeslot mapping and rotation of control channels using 4 time groups for nominal cells (based on an assignment of 1 CPBCCCH and 3 CPCCCHs with NIB\_CCCH\_0 = NIB\_CCCH\_1 = NIB\_CCCH\_2 = NIB\_CCCH\_3 = 4). TG = 0 is illustrated. NIB\_CCCH is not broadcast for serving cell time group

NOTE: For uplink 52-multiframe structure (based on an assignment of 16 prioritized CPRACHs, see subclause 6.3.2.2.3a), replace B( ) by R( ) where R( ) denotes CPRACH, move down one block, and rotate according to subclause 6.3.2.1. Replace C( ) by R( ) and move down one block. CPRACH in general can be mapped as PRACH in table 6 of clause 7.



Frames 0-51 of a 208-multiframe MFN = 0								Frames 52-103 of a 208-multiframe MFN = 1								Frames 104-155 of a 208-multiframe MFN = 2								Frames 156-207 of a 208-multiframe MFN = 3											
TS	0	1	2	3	4	5	6	7	TS	0	1	2	3	4	5	6	7	TS	0	1	2	3	4	5	6	7	TS	0	1	2	3	4	5	6	7
FN									FN									FN									FN								
0	B(0) <sup>0</sup>	X <sup>1</sup>	X <sup>2</sup>						52	X <sup>1</sup>	X <sup>2</sup>					B(0) <sup>0</sup>		104	X <sup>2</sup>				B(0) <sup>0</sup>	X <sup>1</sup>			156				B(0) <sup>0</sup>	X <sup>1</sup>	X <sup>2</sup>		
1	B(0) <sup>0</sup>	X <sup>1</sup>	X <sup>2</sup>						53	X <sup>1</sup>	X <sup>2</sup>					B(0) <sup>0</sup>		105	X <sup>2</sup>				B(0) <sup>0</sup>	X <sup>1</sup>			157				B(0) <sup>0</sup>	X <sup>1</sup>	X <sup>2</sup>		
2	B(0) <sup>0</sup>	X <sup>1</sup>	X <sup>2</sup>						54	X <sup>1</sup>	X <sup>2</sup>					B(0) <sup>0</sup>		106	X <sup>2</sup>				B(0) <sup>0</sup>	X <sup>1</sup>			158				B(0) <sup>0</sup>	X <sup>1</sup>	X <sup>2</sup>		
3	B(0) <sup>0</sup>	X <sup>1</sup>	X <sup>2</sup>						55	X <sup>1</sup>	X <sup>2</sup>					B(0) <sup>0</sup>		107	X <sup>2</sup>				B(0) <sup>0</sup>	X <sup>1</sup>			159				B(0) <sup>0</sup>	X <sup>1</sup>	X <sup>2</sup>		
4									56									108									160								
5									57									109									161								
6									58									110									162								
7									59									111									163								
8									60									112									164								
9									61									113									165								
10									62									114									166								
11									63									115									167								
12									64									116									168								
13									65									117									169								
14	X <sup>1</sup>	X <sup>2</sup>						C(3) <sup>0</sup>	66	X <sup>2</sup>					C(3) <sup>0</sup>	X <sup>1</sup>		118									170	C(3) <sup>0</sup>	X <sup>1</sup>	X <sup>2</sup>					
15	X <sup>1</sup>	X <sup>2</sup>						C(3) <sup>0</sup>	67	X <sup>2</sup>					C(3) <sup>0</sup>	X <sup>1</sup>		119									171	C(3) <sup>0</sup>	X <sup>1</sup>	X <sup>2</sup>					
16	X <sup>1</sup>	X <sup>2</sup>						C(3) <sup>0</sup>	68	X <sup>2</sup>					C(3) <sup>0</sup>	X <sup>1</sup>		120									172	C(3) <sup>0</sup>	X <sup>1</sup>	X <sup>2</sup>					
17									69									121									173								
18									70									122									174								
19									71									123									175								
20									72									124									176								
21									73									125									177								
22									74									126									178								
23									75									127									179								
24									76									128									180								
25									77									129									181	ID	CFCCH <sup>3</sup>						
26									78									130									182								
27	X <sup>1</sup>	X <sup>2</sup>						C(6) <sup>0</sup>	79	X <sup>2</sup>					C(6) <sup>0</sup>	X <sup>1</sup>		131									183	C(6) <sup>0</sup>	X <sup>1</sup>	X <sup>2</sup>					
28	X <sup>1</sup>	X <sup>2</sup>						C(6) <sup>0</sup>	80	X <sup>2</sup>					C(6) <sup>0</sup>	X <sup>1</sup>		132									184	C(6) <sup>0</sup>	X <sup>1</sup>	X <sup>2</sup>					
29	X <sup>1</sup>	X <sup>2</sup>						C(6) <sup>0</sup>	81	X <sup>2</sup>					C(6) <sup>0</sup>	X <sup>1</sup>		133									185	C(6) <sup>0</sup>	X <sup>1</sup>	X <sup>2</sup>					
30									82									134									186								
31									83									135									187								
32									84									136									188								
33									85									137									189								
34									86									138									190								
35									87									139									191								
36									88									140									192								
37									89									141									193								
38									90									142									194								
39									91									143									195								
40	X <sup>1</sup>	X <sup>2</sup>						C(9) <sup>0</sup>	92	X <sup>2</sup>					C(9) <sup>0</sup>	X <sup>1</sup>		144									196	C(9) <sup>0</sup>	X <sup>1</sup>	X <sup>2</sup>					
41	X <sup>1</sup>	X <sup>2</sup>						C(9) <sup>0</sup>	93	X <sup>2</sup>					C(9) <sup>0</sup>	X <sup>1</sup>		145									197	C(9) <sup>0</sup>	X <sup>1</sup>	X <sup>2</sup>					
42	X <sup>1</sup>	X <sup>2</sup>						C(9) <sup>0</sup>	94	X <sup>2</sup>					C(9) <sup>0</sup>	X <sup>1</sup>		146									198	C(9) <sup>0</sup>	X <sup>1</sup>	X <sup>2</sup>					
43									95									147									199								
44									96									148									200								
45									97									149									201								
46									98									150									202								
47									99									151									203								
48									100									152									204								
49									101									153									205								
50									102									154									206								
51									103									155									207	ID	CSCH <sup>3</sup>						

**Figure D.6: Example of COMPACT downlink timeslot mapping and rotation of control channels using 3 time groups for nominal cells (based on an assignment of 1 CPBCCCH and 3 CPCCCHs with NIB\_CCCH\_0 = NIB\_CCCH\_1 = NIB\_CCCH\_2 = 4, NIB\_CCCH\_3 = 0). TG = 0 is illustrated. NIB\_CCCH is not broadcast for serving cell time group**

NOTE: For uplink 52-multiframe structure (based on an assignment of 16 prioritized CPRACHs, see subclause 6.3.2.2.3a), replace B( ) by R( ) where R( ) denotes CPRACH, move down one block, and rotate according to subclause 6.3.2.1. Replace C( ) by R( ) and move down one block. CPRACH in general can be mapped as PRACH in table 6 of clause 7.

Frames 0-51 of a 208-multiframe MFN = 0								Frames 52-103 of a 208-multiframe MFN = 1								Frames 104-155 of a 208-multiframe MFN = 2								Frames 156-207 of a 208-multiframe MFN = 3											
TS	0	1	2	3	4	5	6	7	TS	0	1	2	3	4	5	6	7	TS	0	1	2	3	4	5	6	7	TS	0	1	2	3	4	5	6	7
FN									FN									FN									FN								
0	B(0) <sup>0</sup>	X <sup>1</sup>	X <sup>2</sup>	X <sup>3</sup>					52	X <sup>1</sup>	X <sup>2</sup>	X <sup>3</sup>	B(0) <sup>0</sup>					104	X <sup>2</sup>	X <sup>3</sup>	B(0) <sup>0</sup>	X <sup>1</sup>					156	X <sup>3</sup>	B(0) <sup>0</sup>	X <sup>1</sup>	X <sup>2</sup>				
1	B(0) <sup>0</sup>	X <sup>1</sup>	X <sup>2</sup>	X <sup>3</sup>					53	X <sup>1</sup>	X <sup>2</sup>	X <sup>3</sup>	B(0) <sup>0</sup>					105	X <sup>2</sup>	X <sup>3</sup>	B(0) <sup>0</sup>	X <sup>1</sup>					157	X <sup>3</sup>	B(0) <sup>0</sup>	X <sup>1</sup>	X <sup>2</sup>				
2	B(0) <sup>0</sup>	X <sup>1</sup>	X <sup>2</sup>	X <sup>3</sup>					54	X <sup>1</sup>	X <sup>2</sup>	X <sup>3</sup>	B(0) <sup>0</sup>					106	X <sup>2</sup>	X <sup>3</sup>	B(0) <sup>0</sup>	X <sup>1</sup>					158	X <sup>3</sup>	B(0) <sup>0</sup>	X <sup>1</sup>	X <sup>2</sup>				
3	B(0) <sup>0</sup>	X <sup>1</sup>	X <sup>2</sup>	X <sup>3</sup>					55	X <sup>1</sup>	X <sup>2</sup>	X <sup>3</sup>	B(0) <sup>0</sup>					107	X <sup>2</sup>	X <sup>3</sup>	B(0) <sup>0</sup>	X <sup>1</sup>					159	X <sup>3</sup>	B(0) <sup>0</sup>	X <sup>1</sup>	X <sup>2</sup>				
4	X <sup>1</sup>								56				X <sup>1</sup>					108			X <sup>1</sup>						160		X <sup>1</sup>						
5	X <sup>1</sup>								57				X <sup>1</sup>					109			X <sup>1</sup>						161		X <sup>1</sup>						
6	X <sup>1</sup>								58				X <sup>1</sup>					110			X <sup>1</sup>						162		X <sup>1</sup>						
7	X <sup>1</sup>								59				X <sup>1</sup>					111			X <sup>1</sup>						163		X <sup>1</sup>						
8									60									112									164								
9									61									113									165								
10									62									114									166								
11									63									115									167								
12									64									116									168								
13									65									117									169								
14	X <sup>1</sup>	X <sup>2</sup>	X <sup>3</sup>	C(3) <sup>0</sup>					66	X <sup>2</sup>	X <sup>3</sup>	C(3) <sup>0</sup>	X <sup>1</sup>					118	X <sup>3</sup>	C(3) <sup>0</sup>	X <sup>1</sup>	X <sup>2</sup>					170	C(3) <sup>0</sup>	X <sup>1</sup>	X <sup>2</sup>	X <sup>3</sup>				
15	X <sup>1</sup>	X <sup>2</sup>	X <sup>3</sup>	C(3) <sup>0</sup>					67	X <sup>2</sup>	X <sup>3</sup>	C(3) <sup>0</sup>	X <sup>1</sup>					119	X <sup>3</sup>	C(3) <sup>0</sup>	X <sup>1</sup>	X <sup>2</sup>					171	C(3) <sup>0</sup>	X <sup>1</sup>	X <sup>2</sup>	X <sup>3</sup>				
16	X <sup>1</sup>	X <sup>2</sup>	X <sup>3</sup>	C(3) <sup>0</sup>					68	X <sup>2</sup>	X <sup>3</sup>	C(3) <sup>0</sup>	X <sup>1</sup>					120	X <sup>3</sup>	C(3) <sup>0</sup>	X <sup>1</sup>	X <sup>2</sup>					172	C(3) <sup>0</sup>	X <sup>1</sup>	X <sup>2</sup>	X <sup>3</sup>				
17									69									121									173								
18									70									122									174								
19									71									123									175								
20									72									124									176								
21									73									125									177								
22									74									126									178								
23									75									127									179								
24									76									128									180								
25									77									129									181								
26									78									130									182								
27	X <sup>1</sup>	X <sup>2</sup>	X <sup>3</sup>	C(6) <sup>0</sup>					79	X <sup>2</sup>	X <sup>3</sup>	C(6) <sup>0</sup>	X <sup>1</sup>					131	X <sup>3</sup>	C(6) <sup>0</sup>	X <sup>1</sup>	X <sup>2</sup>					183	C(6) <sup>0</sup>	X <sup>1</sup>	X <sup>2</sup>	X <sup>3</sup>				
28	X <sup>1</sup>	X <sup>2</sup>	X <sup>3</sup>	C(6) <sup>0</sup>					80	X <sup>2</sup>	X <sup>3</sup>	C(6) <sup>0</sup>	X <sup>1</sup>					132	X <sup>3</sup>	C(6) <sup>0</sup>	X <sup>1</sup>	X <sup>2</sup>					184	C(6) <sup>0</sup>	X <sup>1</sup>	X <sup>2</sup>	X <sup>3</sup>				
29	X <sup>1</sup>	X <sup>2</sup>	X <sup>3</sup>	C(6) <sup>0</sup>					81	X <sup>2</sup>	X <sup>3</sup>	C(6) <sup>0</sup>	X <sup>1</sup>					133	X <sup>3</sup>	C(6) <sup>0</sup>	X <sup>1</sup>	X <sup>2</sup>					185	C(6) <sup>0</sup>	X <sup>1</sup>	X <sup>2</sup>	X <sup>3</sup>				
30									82									134									186								
31									83									135									187								
32									84									136									188								
33									85									137									189								
34									86									138									190								
35									87									139									191								
36									88									140									192								
37									89									141									193								
38									90									142									194								
39									91									143									195								
40	X <sup>1</sup>	X <sup>2</sup>	X <sup>3</sup>	C(9) <sup>0</sup>					92	X <sup>2</sup>	X <sup>3</sup>	C(9) <sup>0</sup>	X <sup>1</sup>					144	X <sup>3</sup>	C(9) <sup>0</sup>	X <sup>1</sup>	X <sup>2</sup>					196	C(9) <sup>0</sup>	X <sup>1</sup>	X <sup>2</sup>	X <sup>3</sup>				
41	X <sup>1</sup>	X <sup>2</sup>	X <sup>3</sup>	C(9) <sup>0</sup>					93	X <sup>2</sup>	X <sup>3</sup>	C(9) <sup>0</sup>	X <sup>1</sup>					145	X <sup>3</sup>	C(9) <sup>0</sup>	X <sup>1</sup>	X <sup>2</sup>					197	C(9) <sup>0</sup>	X <sup>1</sup>	X <sup>2</sup>	X <sup>3</sup>				
42	X <sup>1</sup>	X <sup>2</sup>	X <sup>3</sup>	C(9) <sup>0</sup>					94	X <sup>2</sup>	X <sup>3</sup>	C(9) <sup>0</sup>	X <sup>1</sup>					146	X <sup>3</sup>	C(9) <sup>0</sup>	X <sup>1</sup>	X <sup>2</sup>					198	C(9) <sup>0</sup>	X <sup>1</sup>	X <sup>2</sup>	X <sup>3</sup>				
43									95									147									199								
44									96									148									200								
45									97									149									201								
46									98									150									202								
47									99									151									203								
48									100									152									204								
49									101									153									205								
50									102									154									206								
51									103									155									207								

Figure D.7: Example of COMPACT downlink timeslot mapping and rotation of control channels using 4 time groups for nominal cells (based on an assignment of 1 CPBCCCH and 3 CPCCCHs with NIB\_CCCH\_0 = NIB\_CCCH\_2 = NIB\_CCCH\_3 = 4, NIB\_CCCH\_1 = 5). TG = 0 is illustrated. NIB\_CCCH is not broadcast for serving cell time group

NOTE: For uplink 52-multiframe structure (based on an assignment of 16 prioritized CPRACHs, see subclause 6.3.2.2.3a), replace B( ) by R( ) where R( ) denotes CPRACH, move down one block, and rotate according to subclause 6.3.2.1. Replace C( ) by R( ) and move down one block. CPRACH in general can be mapped as PRACH in table 6 of clause 7.

# Annex E (informative): Example illustrations of neighbour cell measurements for downlink dual carrier MS

Figure E.1 illustrates possible switching and measurement timings for downlink dual carrier MSs that have a higher equivalent multislots class compared to the signalled multislots class (see subclause B.4).

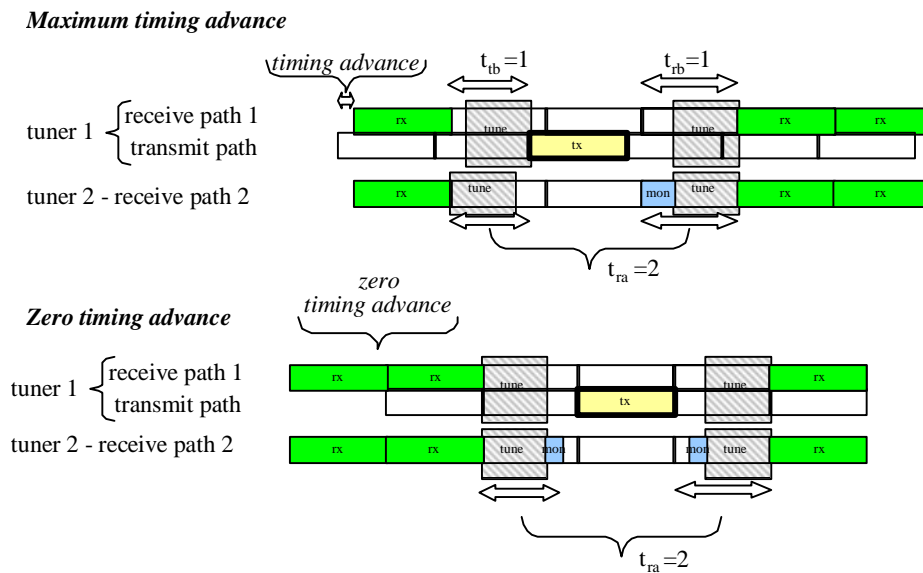

Figure E.1

## Annex F (informative): Illustration of mapping restrictions in Downlink Multi Carrier

The mapping restrictions for DLMC described in subclause 6.2.7 can be illustrated by the following example with 5 carriers assigned in BTTI mode:

max\_sep: 22 (corresponding to a supported *DLMC - Maximum BW* of 5 MHz, see 3GPP TS 45.005).

num\_tdma\_frames: 4.

num\_carriers: 5.

arfcn[1..num\_tdma\_frames][1..num\_carriers]: see the table below.

TDMA frame index (i)	arfcn[i][1]	arfcn[i][2]	arfcn[i][3]	arfcn[i][4]	arfcn[i][5]
1	1	10	19	37	23
2	46	1	10	28	23
3	37	46	1	19	23
4	1	10	19	37	23

### Contiguous reception:

Step 1: Set carrier 1 as the anchor, and test whether carrier 2 can be selected. As shown in the table below, carrier separation is not satisfied for one or more of the 4 TDMA frames (in this case not satisfied for the second TDMA frame), hence carrier 2 is not selected. Carrier selection for the current anchor stops. The selected group of carriers for anchor carrier 1 is {1}. Since this is the first group of carriers selected, it is set as the currently selected group of carriers.

TDMA frame index (i)	arfcn[i][1]	arfcn[i][2]	min arfcn	max arfcn	delta arfcn	delta arfcn <= max_sep?
1	1	10	1	10	9	Yes
2	46	1	1	46	45	No
3	37	46	37	46	9	Yes
4	1	10	1	10	9	Yes

Step 2: Set carrier 2 as the anchor, and test whether carrier 3 can be selected. As shown in the table below, carrier separation is not satisfied for one or more of the 4 TDMA frames (in this case not satisfied for the third TDMA frame), hence carrier 3 is not selected. Carrier selection for the current anchor stops. The selected group of carriers for anchor carrier 2 is {2}. Since the size of this group of carriers is not greater than the currently selected group of carriers (i.e. {1}), the latter is not changed.

TDMA frame index (i)	arfcn[i][2]	arfcn[i][3]	min arfcn	max arfcn	delta arfcn	delta arfcn <= max_sep?
1	10	19	10	19	9	Yes
2	1	10	1	10	9	Yes
3	46	1	1	46	45	No
4	10	19	1	10	9	Yes

Step 3: Set carrier 3 as the anchor, and test whether carrier 4 can be selected. As shown in the table below, carrier separation is satisfied for all 4 TDMA frames, hence carrier 4 is selected.

TDMA frame index (i)	arfcn[i][3]	arfcn[i][4]	min arfcn	max arfcn	delta arfcn	delta arfcn <= max_sep?
1	19	37	19	37	18	Yes
2	10	28	10	28	18	Yes
3	1	19	1	19	18	Yes
4	19	37	19	37	18	Yes

Step 4: Test whether carrier 5 can be selected. As shown in the table below, carrier separation is satisfied for all 4 TDMA frames, hence carrier 5 is selected. Since there are no more carriers to be processed, carrier selection for the current anchor stops. The selected group of carriers for anchor carrier 3 is {3, 4, 5}. Since the size of this group of carriers is greater than the currently selected group of carriers (i.e. {1}), the latter is changed to {3, 4, 5}.

TDMA frame index (i)	arfcn[i][3]	arfcn[i][4]	arfcn[i][5]	min arfcn	max arfcn	delta arfcn	delta arfcn <= max_sep?
1	19	37	23	19	37	18	Yes
2	10	28	23	10	28	18	Yes
3	1	19	23	1	23	22	Yes
4	19	37	23	19	37	18	Yes

Step 5: Since there are no more carriers to be processed, the carrier selection method stops. The finally selected group of carriers is {3, 4, 5}.

#### Non-contiguous reception:

Step 1: Perform the steps for contiguous reception with  $\text{max\_sep}=2 \times 22=44$ . The finally selected group of carriers in this step is {3, 4, 5}, i.e. not all carriers can be selected.

Step 2: Perform the steps for contiguous reception with  $\text{max\_sep}=22$ . The finally selected group of carriers in this step is {3, 4, 5}.

Step 3: Perform the steps for contiguous reception with  $\text{max\_sep}=22$ ,  $\text{num\_carriers}=5-3=2$ , and arfcn excluding vectors for carrier 3, carrier 4 and carrier 5. The finally selected group of carriers in this step is {1}.

Step 4: The carrier selection method stops. The finally selected group of carriers is  $\{3, 4, 5\} + \{1\} = \{3, 4, 5, 1\}$ .

## Annex G (informative): Change history

SPEC	SMG#	CR	PH	VERS	NEW_VERS	SUBJECT
05.02	s24	A020	R97	5.5.0A	6.0.0	Corrections and clarifications to GPRS
05.02	s24	A021	R97	5.5.0A	6.0.0	Multislot classes for GPRS
05.02	s24	A022	R97	5.5.0A	6.0.0	System information for GPRS on BCCH
05.02	s24	A023	R97	5.5.0A	6.0.0	Alignment of 51- and 52-multiframe PCCCH
05.02	s25	A025	R97	6.0.1	6.1.0	Corrections to the GPRS sleep mode
05.02	s25	A026	R97	6.0.1	6.1.0	Clarification of the definition of multislot classes
05.02	s25	A030	R97	6.0.1	6.1.0	14.4kbps Data Service
05.02	s25	A034	R97	6.0.1	6.1.0	Indication of PACCH logical channel type
05.02	s25	A035	R97	6.0.1	6.1.0	Renaming of GPRS RR states
05.02	s25	A036	R97	6.0.1	6.1.0	USF granularity for dynamic allocation
05.02	s26	A033	R97	6.1.0	6.2.0	GPRS SI message mapping
05.02	s26	A037	R97	6.1.0	6.2.0	Mapping of PACCH
05.02	s26	A039	R97	6.1.0	6.2.0	Mapping of SI 2 and SI 2ter on BCCH
05.02	s27	A041	R97	6.2.0	6.3.0	Clarification on PTCCH/U mapping
05.02	s27	A042	R97	6.2.0	6.3.0	Clarification on mapping PCCCH
05.02	s27	A043	R97	6.2.0	6.3.0	MS multislot classes and GPRS dynamic allocations
05.02	s28	A045	R97	6.3.0	6.4.0	Removal of System Information Type 14
05.02	s28	A052	R97	6.3.0	6.4.0	Schedule for packet System Information message on PBCCH
05.02	s28	A054	R97	6.3.0	6.4.0	Editorial correction to 05.02
05.02	s28	A055	R97	6.3.0	6.4.0	Improvements of PRS paging blocks scheduling
05.02	s28	A057	R97	6.3.0	6.4.0	51-multiframe PBCCH
05.02	s28	A060	R97	6.3.0	6.4.0	Clarification to the multislot configurations for GPRS
05.02	s28	A061	R97	6.3.0	6.4.0	Clarification to the PTCCH mapping
05.02	s28	A064	R97	6.3.0	6.4.0	Removal of inconsistency in Table 7
05.02	s28	A048	R98	6.4.0	7.0.0	Introduction of specific training sequences for CTS Synchr. bursts
05.02	s28	A049	R98	6.4.0	7.0.0	Introduction of CTS in 05.02
05.02	s28	A050	R98	6.4.0	7.0.0	CTS Frequency Hopping Algorithm
05.02	s29	A047	R98	7.0.0	7.1.0	Addition of SoLSA functionality
05.02	s29	A065	R98	7.0.0	7.1.0	Editorial modification to GSM 05.02
05.02	s29	A066	R98	7.0.0	7.1.0	Correction of TFH carrier list
05.02	s29	A067	R98	7.0.0	7.1.0	Training sequence code of normal bursts for CTS control channel
05.02	s29	A070	R98	7.0.0	7.1.0	Removal of SI15 references
05.02	s29	A071	R98	7.0.0	7.1.0	Deleting 51-multiframe PBCCH
05.02	s29	A072	R98	7.0.0	7.1.0	Modification of CTSARCH operation
05.02	s29	A077	R98	7.0.0	7.1.0	Correction to non-drx period and SPLIT_PG_CYCLE limitations
05.02	s29	A046	R99	7.1.0	8.0.0	Introduction of 8-PSK burst format
05.02	s29	A074	R99	7.1.0	8.0.1	05.02 changes for ECSD FACCH
05.02	s30	A080	R99	8.0.1	8.1.0	Introduction of AMR and EFR Traffic Channels
05.02	s30	A081	R99	8.0.1	8.1.0	Non-GSM Broadcast Information
05.02	s30	A082	R99	8.0.1	8.1.0	EDGE Compact Cell Reselection
05.02	s30	A083	R99	8.0.1	8.1.0	New training sequences for Access Burst due to EGPRS
05.02	s30	A084	R99	8.0.1	8.1.0	Introduction of Fast Power Control for ECSD in 05.02
05.02	s30	A085	R99	8.0.1	8.1.0	EDGE Compact logical channels
05.02	s30	A098	R99	8.0.1	8.1.0	Mapping of PAGCH
05.02	s30	A101	R99	8.0.1	8.1.0	Clarification of DRX
05.02	s30	A103	R99	8.0.1	8.1.0	Correction when sending SI 16 and 17
05.02	s30b	A095	R99	8.1.0	8.2.0	MS multislot resource restriction in extended TA cells
05.02	s30b	A106	R99	8.1.0	8.2.0	Clarification of fixed allocated PRACH
05.02	s30b	A107	R99	8.1.0	8.2.0	COMPACT Logical Channels
05.02	s30b	A109	R99	8.1.0	8.2.0	Extended Training Sequence Code C-ETSC specific to COMPACT synchronization bursts only

SPEC	SMG#	CR	PH	VERS	NEW_VERS	SUBJECT
05.02	s30b	A110	R99	8.1.0	8.2.0	Support of Slow Frequency Hopping for COMPACT
05.02	s30b	A111	R99	8.1.0	8.2.0	Synchronization of 52-multiframes in EGPRS COMPACT
05.02	s30b	A114	R99	8.1.0	8.2.0	Bi-directional channels in case of multi slot
05.02	s30b	A117	R99	8.1.0	8.2.0	Clarification of multislot configuration
05.02	s30b	A119	R99	8.1.0	8.2.0	Training Sequence to support LCS and specification of 8-PSK modulated normal bursts for compatibility with future releases, mirror CR to R'98
05.02	s30b	A120	R99	8.1.0	8.2.0	Compact FCCH
05.02	s31	A123	R99	8.2.0	8.3.0	PTCCH block numbering
05.02	s31	A126	R99	8.2.0	8.3.0	Correction of BS_PRACH_BLKs range
05.02	s31	A127	R99	8.2.0	8.3.0	COMPACT interference measurements
05.02	s31	A128	R99	8.2.0	8.3.0	Timegroup rotation and NIB Clarification
05.02	s31	A129	R99	8.2.0	8.3.0	Clarifications in 05.02
05.02	s31	A133	R99	8.2.0	8.3.0	USF Handling in COMPACT
05.02	s31	A138	R99	8.2.0	8.3.0	Correction to non-DRX mode
05.02	s31	A142	R99	8.2.0	8.3.0	GPRS & SMS-CB interworking
05.02	s31	A143	R99	8.2.0	8.3.0	Complete Frequency Hopping on COMPACT
05.02	s31b	A148	R99	8.3.0	8.4.0	New measurement order – Idle mode
05.02	s31b	A147	R99	8.3.0	8.4.0	Clarification of PBCCH message scheduling
05.02	s31b	A157	R99	8.3.0	8.4.0	FCCH decoding problem for multislot MS
05.02	s31b	A144	R99	8.3.0	8.4.0	Correction of Figure D.4
05.02	s31b	A149	R99	8.3.0	8.4.0	Correction of NIB parameters
05.02	s32	A158	R99	8.4.0	8.5.0	Clarification of COMPACT frequency hopping parameters
05.02	s32	A159	R99	8.4.0	8.5.0	Class A Dual Transfer Mode (DTM)
	GERAN#					September 2000 - 3GPP GERAN
05.02	G01	A162		8.5.0	8.6.0	DTM (R99)
05.02	G01	A163		8.5.0	8.6.0	Corrections to COMPACT (R99)
05.02	G01	A165		8.5.0	8.6.0	Editorial corrections related to COMPACT (R99)
	GERAN#					September 2000 - 3GPP GERAN#1
05.02	G01	A161		8.6.0	4.0.0	NCH clarification (Release 4)
				4.0.0	4.0.1	Oct 2000: References corrected.
						November 2000 - 3GPP GERAN#2
45.002	G02	002	1	4.0.1	4.1.0	Clarification of mapping of PDTCH and PCCCH
45.002	G02	003		4.0.1	4.1.0	Editorial corrections
45.002	G02	004	1	4.0.1	4.1.0	Possible multislot configurations for GPRS
				4.1.0	4.1.1	Front page layout correction
						January 2001 - 3GPP GERAN#3
45.002	G03	005		4.1.1	4.2.0	Possible multislot configurations for GPRS
45.002	G03	006		4.1.1	4.2.0	Clarification of the monitored GPRS control channels during GPRS attachment



Change history							
Date	TSG GERAN#	TSG Doc.	CR	Rev	Subject/Comment	Old	New
2001-01	03	GP-010241	008		Introduction of Wideband AMR for GMSK modulated speech channel	4.2.0	5.0.0
		GP-010241	007		Correction of CR numbers ( 007 -> 006 / 008->007)	5.0.0	5.0.1
2001-04	04	GP-010872	010	1	Dynamic ARFCN mapping	5.0.1	5.1.0
2001-04	04	GP-010653	012		System Information Type 2 quater scheduling	5.0.1	5.1.0
2001-08	06	GP-011918	020	1	Introduction of enhanced power control channels	5.1.0	5.2.0
2001-08	06	GP-011787	022		Editorial corrections in the hopping sequence generation descriptions	5.1.0	5.2.0
2001-08	06	GP-011608	028		Multislot configurations for 8-PSK	5.1.0	5.2.0
2001-11	07	GP-012746	025	1	Introduction of adaptive half rate speech channels with 8-PSK modulation	5.2.0	5.3.0
2001-11	07	GP-012762	029	1	High multislot classes for type 1 mobiles	5.2.0	5.3.0
2001-11	07	GP-012649	031	1	Training Sequence Code on PBCCH/PCCCH	5.2.0	5.3.0
2001-11	07	GP-012630	033		Correction of minimum number of paging blocks "available" on one PCCCH	5.2.0	5.3.0
2001-11	07	GP-012769	035	1	Correction of references to 3GPP specifications	5.2.0	5.3.0
2002-02	08	GP-020510	036	2	Clarification of permitted channel combinations	5.3.0	5.4.0
2002-02	08	GP-020454	040	1	Multiplexing PDTCH/U,PACCH/U and PCCCH/U	5.3.0	5.4.0
2002-02	08	GP-020478	041	1	Correction on multislot classes and Tra/Tta configurations	5.3.0	5.4.0
2002-04	09	GP-020646	043		Removal of Fixed Allocation	5.4.0	5.5.0
2002-04	09	GP-021205	047	2	Multislot configuration with EPC	5.4.0	5.5.0
2002-04	09	GP-021206	048	1	Introduction of AMR-WB on 8PSK modulated speech traffic channels	5.4.0	5.5.0
2002-04	09	GP-021015	050		Definition of octal traffic channels	5.4.0	5.5.0
2002-06	10	GP-021411	051		Editorial clean up of references	5.5.0	5.6.0
2002-06	10	GP-021668	053		Multislot configurations for OTCH/F	5.5.0	5.6.0
2002-06	10	GP-021669	054		Alignment and additions for lu mode	5.5.0	5.6.0
2002-11	12	GP-023114	055		Inclusion of DBPSCH	5.6.0	5.7.0
2002-11	12	GP-023141	058		Mapping of SI13alt message on BCCH	5.6.0	5.7.0
2002-11	12	GP-023405	059		Correction for SBPSCH in lu Mode DTM	5.6.0	5.7.0
2003-02	13	GP-030379	060	1	Inconsistent specification of <i>lu-mode</i> multislot configurations	5.7.0	5.8.0
2003-02	13	GP-030221	062		Multislot configurations for dual transfer mode	5.7.0	5.8.0
2003-02	13	GP-030222	063		Multislot configurations for DBPSCH in <i>lu mode</i>	5.7.0	5.8.0
2003-02	13	GP-030261	064		Fixed allocation removal correction	5.8.0	6.0.0
2003-04	14	GP-030975	069	1	Mapping of the PDTCH/D on PCCCH in case EGPRS	6.0.0	6.1.0
2003-04	14	GP-030896	072		Corrections for DTM multislot configurations	6.0.0	6.1.0
2003-06	15	GP-031642	078	1	Mapping of the PDTCH/D on PCCCH in case EGPRS	6.1.0	6.2.0
2003-06	15	GP-031713	081	2	Clarification of the Extended Dynamic Allocation	6.1.0	6.2.0
2003-08	16	GP-031906	077	1	Improvements to Extended Dynamic Allocation for high multislot classes	6.2.0	6.3.0
2003-11	17	GP-032463	084		Flexible Layer One	6.3.0	6.4.0
2004-02	18	GP-040179	085		Restrictions on the allowed PBCCH & PCCCH frequency band	6.4.0	6.5.0
2004-04	19	GP-040698	087		Corrections on allowed packet switched multislot configurations	6.5.0	6.6.0
2004-04	19	GP-040701	088		Clarification on USF monitoring in case of extended dynamic allocation	6.5.0	6.6.0
2004-04	19	GP-040725	089		Correction to Figure 9	6.5.0	6.6.0
2004-11	22	GP-042752	090	1	Removal of PTM-M	6.6.0	6.7.0
2004-11	22	GP-042783	091	1	Introduction of MBMS	6.6.0	6.7.0
2005-01	23	GP-050094	092		Correction to mapping of uplink packet channel	6.7.0	6.8.0
2005-01	23	GP-050482	095	1	High multislot class operation on a "d = 1, u = 4" allocation in a legacy network	6.7.0	6.8.0
2005-01	23	GP-050229	096		Provision of cell reselection parameters for neighbouring cells in the serving cell	6.7.0	6.8.0
2005-04	24	GP-051064	097	1	Extension of DTM to high multislot classes	6.8.0	6.9.0
2005-04	24	GP-050709	098		Clarification on non-contiguous assigned timeslots	6.8.0	6.9.0
2005-06	25	GP-051494	100		Corrections for reception of multiple MBMS sessions	6.9.0	6.10.0
2005-09	26	GP-052236	0102	1	Correction to multislot classes allowed for MBMS	6.10.0	6.11.0
2005-11	27	GP-052847	0103	1	MBMS transfer mode	6.11.0	6.12.0

2005-11	27	GP-052849	0106		Correction on the transmission of SI1	6.11.0	6.12.0
2006-04	29	GP-060921	0107	1	Correction of Title of Clause 7 and correspondings	6.12.0	7.0.0
2006-06	30	GP-061338	0108	1	Correction of terminology: 'allocation' vs. 'assignment'	7.0.0	7.1.0
2006-11	32	GP-062442	0113	3	Introduction of Downlink Dual Carrier	7.1.0	7.2.0
2007-02	33	GP-070368	0112	3	Flexible timeslot assignment	7.2.0	7.3.0
2007-02	33	GP-070465	0116	1	Clarification of multislot capabilities for non-DCDL assignments	7.2.0	7.3.0
2007-05	34	GP-070790	0118		Editorial corrections	7.3.0	7.4.0
2007-08	35	GP-071515	0117	5	Introduction of RTTI	7.4.0	7.5.0
2007-08	35	GP-071256	0121		Introduction of RED HOT and HUGE	7.4.0	7.5.0
2007-08	35	GP-071271	0122		Clarification on timeslot configurations for dual carrier in the downlink	7.4.0	7.5.0
2007-11	36	GP-071674	0124		Miscellaneous corrections on Reduced Latency	7.5.0	7.6.0
2007-11	36	GP-071694	0125		Correction on System Information Type 1 scheduling rules	7.5.0	7.6.0
2007-11	36	GP-071956	0126	1	Tail-symbols for EGPRS2	7.5.0	7.6.0
2008-05	38	GP-080783	0127	1	Clarification on guard period	7.6.0	7.7.0
2008-05	38	GP-080874	0128	3	Corrections on Multislot configurations for packet switched connections in A/Gb mode	7.6.0	7.7.0
2008-05	38	GP-080662	0130		Reduced Latency terminology alignments	7.6.0	7.7.0
2008-12	40				Version for Release 8	7.7.0	8.0.0
2009-05	42	GP-091040	0138	1	Enhanced Flexible Timeslot Assignment	8.0.0	9.0.0
2009-09	43	GP-091686	0140	1	Introduction of VAMOS multiplexing and multiple access	9.0.0	9.1.0
2009-11	44	GP-092348	0142	1	Removal of mandatory support for P-channels by mobile stations in A/Gb mode	9.1.0	9.2.0
2010-03	45	GP-100600	0137	5	Introduction of Shifted SACCH mapping for VAMOS	9.2.0	9.3.0
2010-03	45	GP-100340	0143		Clarification of DTM Support for EFTA	9.2.0	9.3.0
2010-03	45	GP-100577	0144	1	Interpretation of Multislot Class Parameters for EFTA	9.2.0	9.3.0
2010-09	47	GP-101557	0146	1	Shifted USF for EFTA	9.3.0	9.4.0
2010-09	47	GP-101407	0147		DCDL for EFTA	9.3.0	9.4.0
2010-09	47	GP-101549	0148	1	TSC allocation for VAMOS in case of DTM	9.3.0	9.4.0
2011-03	49	GP-110465	0152	1	Clarification of Shifted USF operation in combination with Dual Carrier DL	9.4.0	9.5.0
2011-03	49	GP-110454	0153	1	Clarification of Shifted USF in combination with EFTA	9.4.0	9.5.0
2011-03	49	GP-110480	0154	1	Clarifications for support of 8 DL TS operation in EFTA assignment	9.4.0	9.5.0
2011-03	49	GP-110236	0149	1	Introduction of fast downlink frequency switching capability	9.5.0	10.0.0
2011-05	50	GP-110965	0155	3	Realizing Extended Access Barring	10.0.0	10.1.0
2011-09	51	GP-111190	0158		Applicability of reduced switching times for fast downlink frequency switching	10.1.0	10.2.0
2012-03	53	GP-120150	0162	2	Alternative EFTA multislot classes and multislot capabilities applicability for EFTA	10.2.0	10.3.0
2012-08	55	GP-121129	0159	5	Introduction of SI22 message for Network Sharing	10.3.0	11.0.0
2012-11	56	GP-121387	0163	1	Introduction of inter RAT mobility on PLMN basis for Network Sharing	11.0.0	11.1.0
2013-03	57	GP-130273	0166	2	Corrections to multislot capabilities for dual carrier mobile stations	11.1.0	11.2.0
2013-08	59	GP-130881	0172	2	Clarification of VAMOS II mapping of associated control channels	11.2.0	11.3.0
2013-08	59	GP-130738	0176		Measurements and BSIC decoding for EFTA multislot configurations	11.2.0	11.3.0
2013-08	59	GP-130863	0173	1	Introduction of VAMOS III MS	11.3.0	12.0.0
2013-11	60	GP-131052	0168	7	Introduction of Downlink Multi Carrier	12.0.0	12.1.0
2014-08	63	GP-140554	0178		Correction to pseudo code indentation	12.1.0	12.2.0
2014-11	64	GP-140946	0177	4	Introduction of extended TSC sets	12.2.0	12.3.0
2015-03	65	GP-150124	0181		Extended TSC sets correction	12.3.0	12.4.0
2015-11	68	GP-151217	0182	5	Introduction of Power Efficient Operation	12.4.0	13.0.0
2016-02	69	GP-160173	0183	3	Introduction of EC-EGPRS, Multislot capabilities	13.0.0	13.1.0
2016-02	69	GP-160160	0184	6	Introduction of EC-EGPRS, Logical channels	13.0.0	13.1.0
2016-02	69	GP-160197	0185	6	Introduction of EC-EGPRS, Physical channels	13.0.0	13.1.0
2016-02	69	GP-160172	0186	6	Introduction of EC-EGPRS, Mapping of logical channels onto physical channels	13.0.0	13.1.0
2016-02	69	GP-160057	0187		Miscellaneous corrections to eDRX	13.0.0	13.1.0

2016-02	69	GP-160194	0191		Corrections to Overlaid CDMA	13.0.0	13.1.0
---------	----	-----------	------	--	------------------------------	--------	--------

Change history							
Date	Meeting	TDoc	CR	Rev	Cat	Subject/Comment	New version
2016-05	70	GP-160472	0192	3	F	Clarifications and miscellaneous corrections to EC-GSM-IoT (including name change)	13.2.0
2016-05	70	GP-160296	0193		B	Introduction to Radio Frequency Colour Code (RCC)	13.2.0
2016-05	70	GP-160473	0194	2	F	Miscellaneous corrections to eDRX_GSM	13.2.0
2016-05	70	GP-160497	0195	4	C	Energy Efficient EC-CCCH/D Operation	13.2.0
2016-09	73	RP-161393	0198	1	F	Miscellaneous corrections for EC-GSM-IoT	13.3.0
2016-09	73	RP-1613932	0199	4	F	Corrections to EC-GSM-IoT	13.3.0
2016-09	73	RP-161393	0200	1	F	Clarification of PEO Code Point Usage	13.3.0
2016-09						Editorial corrections	13.3.1
2016-12	74	RP-162070	0201	1	F	Miscellaneous corrections	13.4.0
2016-12	74	RP-162070	0202	2	F	Miscellaneous corrections to EC-GSM-IoT	13.4.0
2016-12	74	RP-162066	0203	2	B	Introduction of Alternative Mappings for Higher Coverage Classes with 2 PDCHs	14.0.0
2017-03	75	RP-170061	0204	1	B	Introduction of compact burst mapping	14.1.0
2017-03	75	RP-170060	0205	2	B	Introduction of Extended Access Burst for connectionless Multilateration Positioning	14.1.0
2017-03	75	RP-170063	0208	-	A	Synchronization sequence bits correction	14.1.0
2017-06	76	RP-170924	0206	4	B	Introduction of uplink coverage class CC5 for UL MCL improvement	14.2.0
2017-09	77	RP-171595	0210	-	F	Remove brackets of TS8 for ESAB	14.3.0
2017-09	77	RP-171595	0211	3	F	Training Sequence Selection for CC5 EC-RACH using EDAB	14.3.0
2017-12	78	RP-172188	0212	-	F	Miscellaneous corrections related to CC5 EC-RACH	14.4.0
2018-03	79	RP-180071	0213	-	F	Miscellaneous corrections related to CC5 EC-RACH	14.5.0
2018-06	80	RP-180821	0214	3	B	Energy efficiency enhancements for EC-GSM-IoT MS in idle mode	15.0.0
2018-09	81	RP-181593	0215	-	F	Corrections for EC-PICH	15.1.0
2020-03	87e	RP-200053	0219	-	A	Removal of brackets for extended training sequence of EC-GSM-IoT sync burst	15.2.0
2020-03	87e	RP-200054	0222	-	A	Removal of brackets for "tail bits 4" of EDAB	15.2.0

---

# History

<b>Document history</b>		
V15.0.0	July 2018	Publication
V15.1.0	October 2018	Publication
V15.2.0	April 2020	Publication