

# ETSI TS 148 008 V10.4.0 (2012-01)



**Digital cellular telecommunications system (Phase 2+);  
Mobile Switching Centre - Base Station system (MSC-BSS)  
interface;  
Layer 3 specification  
(3GPP TS 48.008 version 10.4.0 Release 10)**



---

**Reference**

RTS/TSGG-0248008va40

---

**Keywords**

GSM

**ETSI**

650 Route des Lucioles  
F-06921 Sophia Antipolis Cedex - FRANCE

---

Tel.: +33 4 92 94 42 00 Fax: +33 4 93 65 47 16

Siret N° 348 623 562 00017 - NAF 742 C  
Association à but non lucratif enregistrée à la  
Sous-Préfecture de Grasse (06) N° 7803/88

---

**Important notice**

---

Individual copies of the present document can be downloaded from:

<http://www.etsi.org>

The present document may be made available in more than one electronic version or in print. In any case of existing or perceived difference in contents between such versions, the reference version is the Portable Document Format (PDF). In case of dispute, the reference shall be the printing on ETSI printers of the PDF version kept on a specific network drive within ETSI Secretariat.

Users of the present document should be aware that the document may be subject to revision or change of status. Information on the current status of this and other ETSI documents is available at

<http://portal.etsi.org/tb/status/status.asp>

If you find errors in the present document, please send your comment to one of the following services:

[http://portal.etsi.org/chaicor/ETSI\\_support.asp](http://portal.etsi.org/chaicor/ETSI_support.asp)

---

**Copyright Notification**

---

No part may be reproduced except as authorized by written permission.  
The copyright and the foregoing restriction extend to reproduction in all media.

© European Telecommunications Standards Institute 2012.  
All rights reserved.

**DECT™**, **PLUGTESTS™**, **UMTS™** and the ETSI logo are Trade Marks of ETSI registered for the benefit of its Members.  
**3GPP™** and **LTE™** are Trade Marks of ETSI registered for the benefit of its Members and  
of the 3GPP Organizational Partners.  
**GSM®** and the GSM logo are Trade Marks registered and owned by the GSM Association.

---

## Intellectual Property Rights

IPRs essential or potentially essential to the present document may have been declared to ETSI. The information pertaining to these essential IPRs, if any, is publicly available for **ETSI members and non-members**, and can be found in ETSI SR 000 314: *"Intellectual Property Rights (IPRs); Essential, or potentially Essential, IPRs notified to ETSI in respect of ETSI standards"*, which is available from the ETSI Secretariat. Latest updates are available on the ETSI Web server (<http://ipr.etsi.org>).

Pursuant to the ETSI IPR Policy, no investigation, including IPR searches, has been carried out by ETSI. No guarantee can be given as to the existence of other IPRs not referenced in ETSI SR 000 314 (or the updates on the ETSI Web server) which are, or may be, or may become, essential to the present document.

---

## Foreword

This Technical Specification (TS) has been produced by ETSI 3rd Generation Partnership Project (3GPP).

The present document may refer to technical specifications or reports using their 3GPP identities, UMTS identities or GSM identities. These should be interpreted as being references to the corresponding ETSI deliverables.

The cross reference between GSM, UMTS, 3GPP and ETSI identities can be found under <http://webapp.etsi.org/key/queryform.asp>.

# Contents

Intellectual Property Rights .....	2
Foreword.....	2
Foreword.....	11
1 Scope .....	12
1.1 References .....	12
1.2 Definitions and Abbreviations.....	14
2 Application to interface structures .....	14
2.1 The BSS Operation and Maintenance Application Part .....	15
2.2 The Direct Transfer Application Part .....	15
2.3 The BSS Management Application Part.....	15
2.4 Handling of abnormal events related to the BSSAP Header .....	15
3 The BSS Management Application Part .....	16
3.1 BSSMAP Procedures .....	16
3.1.1 Assignment .....	17
3.1.1.1 Successful Operation.....	17
3.1.1.2 Assignment Failure .....	19
3.1.1.3 Abnormal Conditions .....	21
3.1.2 Blocking and Unblocking .....	21
3.1.2.1 Successful Operation.....	21
3.1.2.2 Abnormal Conditions .....	23
3.1.2.2.1 Applying to the Single Circuit Block Procedure .....	23
3.1.2.2.2 Applying to the Circuit Group Block Procedure .....	23
3.1.3 Resource Indication .....	24
3.1.3.1 Successful Operation.....	25
3.1.4 Reset .....	26
3.1.4.1 Global Reset Procedure.....	26
3.1.4.1.1 Reset at the BSS .....	26
3.1.4.1.2 Reset at the MSC .....	26
3.1.4.1.3 Abnormal Conditions .....	27
3.1.4.1.3.1 Abnormal Condition at the BSS.....	27
3.1.4.1.3.2 Abnormal Condition at the MSC .....	27
3.1.4.2 Reset Circuit.....	27
3.1.4.2.1 Reset Circuit at the BSS .....	27
3.1.4.2.2 Reset Circuit at the MSC .....	27
3.1.4.2.3 Abnormal conditions .....	27
3.1.4.3 Reset IP Resource .....	28
3.1.4.3.1 Reset IP Resource procedure initiated by the BSS .....	28
3.1.4.3.2 Reset IP Resource procedure initiated by the MSC.....	28
3.1.4.3.3 Abnormal conditions .....	28
3.1.5 External Handover .....	29
3.1.5.1 Handover Required Indication .....	29
3.1.5.1.1 Generation of the HANDOVER REQUIRED message .....	30
3.1.5.1.2 Abnormal conditions for DTM Handover .....	32
3.1.5.2 Handover Resource allocation .....	33
3.1.5.2.1 Operation of the procedure .....	33
3.1.5.2.2 Handover Resource Allocation Failure .....	36
3.1.5.2.3 Abnormal conditions .....	37
3.1.5.3 Handover execution .....	38
3.1.5.3.1 Operation of the procedure .....	38
3.1.5.3.2 Handover Failure.....	40
3.1.5.3.3 Abnormal Conditions .....	40
3.1.5a Handover from GSM to another System.....	41
3.1.5a.1 Generation of the HANDOVER REQUIRED message for intersystem handover .....	41
3.1.5a.2 Inter-System Handover Resource Allocation Failure.....	42

3.1.5a.3	Intersystem handover Execution .....	43
3.1.5a.4	Inter System Handover Failure .....	44
3.1.5a.5	Abnormal Conditions .....	44
3.1.5b	Handover from another system to GSM .....	44
3.1.5b.1	General .....	44
3.1.5b.2	Inter-System Handover Resource Allocation .....	45
3.1.5c	BSS Internal Handover with MSC support .....	45
3.1.5c.1	Internal Handover Preparation .....	45
3.1.5c.1.1	Internal Handover Required Reject .....	46
3.1.5c.2	Internal Handover Execution .....	46
3.1.5c.2.1	Internal Handover failure .....	47
3.1.5c.2.2	Abnormal Conditions .....	47
3.1.5c.3	Internal Handover Enquiry .....	47
3.1.6	Internal Intra-Cell Handover Procedure .....	48
3.1.7	Internal Inter-Cell Handover Procedure .....	49
3.1.8	Handover Candidate Enquiry .....	49
3.1.8.1	Successful Operation .....	50
3.1.8.2	Abnormal conditions .....	50
3.1.9	Release of Radio Resource And Terrestrial Resource .....	50
3.1.9.1	Release Due To Transaction Completion .....	50
3.1.9.1a	Release of radio resources and the terrestrial resources for VGCS/VBS calls: .....	51
3.1.9.2	Release due to BSS generated reason .....	51
3.1.9.3	Release due to successful handover .....	53
3.1.9.4	Release due to uplink release .....	53
3.1.10	Paging .....	53
3.1.11	Trace Invocation .....	53
3.1.12	Flow Control .....	54
3.1.12.1	Philosophy .....	54
3.1.12.2	Processor Overload at the MSC .....	54
3.1.12.3	Processor/CCCH overload at the BSS .....	54
3.1.12.4	Message throughput congestion .....	55
3.1.13	Classmark Handling Procedures .....	55
3.1.13.1	Classmark request procedure .....	55
3.1.13.2	Classmark updating procedure .....	55
3.1.14	Cipher Mode Control .....	55
3.1.14.1	Successful Operation .....	55
3.1.14.2	Abnormal Conditions .....	56
3.1.15	General SCCP Abnormal Conditions .....	56
3.1.16	Initial MS message .....	57
3.1.17	Queuing Indication .....	57
3.1.17.1	Operation of the procedure in case of assignment procedure .....	57
3.1.17.2	Operation of the procedure in case of hand-over resource allocation procedure .....	57
3.1.18	Data Link Control SAPI not Equal to "0" .....	58
3.1.18.1	Data link set up across the radio interface .....	58
3.1.18.1.1	MS to MSC direction .....	58
3.1.18.1.2	MSC to MS Direction .....	58
3.1.18.2	Choice of the signalling link .....	58
3.1.19	BSSMAP Error Handling .....	58
3.1.19.1	Definitions of Types of Information Elements .....	59
3.1.19.2	Erroneous Events .....	59
3.1.19.3	Non-erroneous Events .....	60
3.1.19.4	Other Events .....	60
3.1.19.5	Appropriate Error Message and Cause Value .....	60
3.1.19.6	Unequipped Circuit Identification Code .....	61
3.1.19.7	Field Elements .....	62
3.1.20	Load Indication Procedure .....	62
3.1.20.1	Operation of the procedure .....	63
3.1.21	Voice group call service and voice broadcast service call set-up and resource assignment .....	63
3.1.21.1	Successful operation .....	64
3.1.21.2	VGCS/VBS call set-up abnormal cases .....	64
3.1.21.3	VGCS/VBS call set-up failure .....	64
3.1.22	Voice group call service and voice broadcast service Assignment procedure .....	64

3.1.22.1	Successful operation.....	64
3.1.22.2	VGCS/VBS Assignment abnormal cases.....	67
3.1.22.3	VGCS/VBS Assignment failure.....	68
3.1.22.4	VGCS/VBS Queuing Indication .....	68
3.1.23	(void) .....	69
3.1.24	Voice group call uplink control procedure - talker priority not supported by the network.....	69
3.1.24.1	Uplink allocation procedure.....	69
3.1.24.1.1	Successful uplink allocation operation .....	69
3.1.24.1.2	Unsuccessful uplink allocation operation.....	69
3.1.24.2	Uplink release procedure.....	69
3.1.24.3	Uplink seize procedure.....	70
3.1.24a	Voice group call uplink control procedure - talker priority supported by the network.....	70
3.1.24a.1	General.....	70
3.1.24a.2	Uplink allocation procedure.....	70
3.1.24a.2.1	Successful uplink allocation operation .....	71
3.1.24a.2.1.1	Normal Priority Request .....	71
3.1.24a.2.1.2	Privileged or Emergency Priority Request via Uplink Access procedure.....	71
3.1.24a.2.1.3	Privileged or Emergency Priority Request via Priority Uplink Request procedure.....	71
3.1.24a.2.2	Unsuccessful uplink allocation operation.....	71
3.1.24a.2.2.1	Normal Priority Uplink Request .....	71
3.1.24a.2.2.2	Privileged or Emergency Uplink Request via Uplink Access procedure.....	72
3.1.24a.2.2.3	Privileged or Emergency Uplink Request via Priority Uplink Request procedure .....	72
3.1.24a.3	Uplink release procedure.....	72
3.1.24a.4	Uplink seize procedure.....	72
3.1.24a.5	Emergency Reset procedure via UPLINK ACCESS message.....	72
3.1.24a.5.1	Unsuccessful .....	73
3.1.24a.6	Emergency Reset procedure via PRIORITY UPLINK REQUEST message.....	73
3.1.24a.6.1	Unsuccessful .....	73
3.1.24b	Talker Information.....	73
3.1.24c	SMS to ongoing VGCS call.....	73
3.1.24d	Distributing application-specific data to ongoing VGCS call.....	74
3.1.25	PDSS1 flow control .....	74
3.1.26	Circuit re-selection procedure.....	74
3.1.27	LSA handling.....	75
3.1.28	Location Acquisition.....	75
3.1.28.1	(void).....	75
3.1.28.2	Location request.....	75
3.1.28.2.1	Successful Operation.....	75
3.1.28.2.2	Unsuccessful Operation .....	76
3.1.28.2.3	Abnormal cases .....	76
3.1.28.2.4	Overload .....	76
3.1.29	Connectionless Information Transfer procedure.....	76
3.1.29.1	Unsuccessful Operation.....	77
3.1.29.2	Abnormal cases .....	77
3.1.29.3	Segmentation .....	77
3.1.30	Common ID .....	77
3.1.31	VGCS/VBS Cell Re-established - no A-interface link sharing.....	77
3.1.32	Rerouting procedure in case of MOCN configuration for network sharing.....	78
3.1.32.1	General.....	78
3.1.32.2	Reroute command .....	78
3.1.32.3	Reroute complete .....	79
3.1.32.4	Abnormal Conditions .....	79
3.1.33	Local Call Local Switch .....	79
3.1.33.1	General.....	79
3.1.33.2	Local switch establishment .....	79
3.1.33.2.1	Call Leg Correlation .....	79
3.1.33.2.2	Successful Operation .....	79
3.1.33.2.3	Unsuccessful Operation.....	80
3.1.33.3	Local switch break .....	80
3.1.33.3.1	Local switching break request from MSC .....	80
3.1.33.3.2	Local switching break initiated by BSS.....	81
3.1.33.3.3	Local Switching break at Handover .....	81

3.1.33.4	Local switch prevention .....	81
3.1.33.5	LCLS Notification.....	81
3.2	Message Formats and Coding .....	82
3.2.1	Message Contents .....	85
3.2.1.1	ASSIGNMENT REQUEST .....	85
3.2.1.2	ASSIGNMENT COMPLETE .....	86
3.2.1.3	ASSIGNMENT FAILURE .....	88
3.2.1.4	BLOCK .....	89
3.2.1.5	BLOCKING ACKNOWLEDGE .....	89
3.2.1.6	UNBLOCK .....	89
3.2.1.7	UNBLOCKING ACKNOWLEDGE .....	89
3.2.1.8	HANDOVER REQUEST .....	90
3.2.1.9	HANDOVER REQUIRED .....	93
3.2.1.10	HANDOVER REQUEST ACKNOWLEDGE.....	94
3.2.1.11	HANDOVER COMMAND .....	96
3.2.1.12	HANDOVER COMPLETE .....	96
3.2.1.13	HANDOVER SUCCEEDED .....	97
3.2.1.14	HANDOVER CANDIDATE ENQUIRE.....	97
3.2.1.15	HANDOVER CANDIDATE RESPONSE .....	97
3.2.1.16	HANDOVER FAILURE .....	97
3.2.1.17	RESOURCE REQUEST .....	99
3.2.1.18	RESOURCE INDICATION .....	99
3.2.1.19	PAGING .....	100
3.2.1.20	CLEAR REQUEST.....	100
3.2.1.21	CLEAR COMMAND .....	101
3.2.1.22	CLEAR COMPLETE.....	101
3.2.1.23	RESET .....	101
3.2.1.24	RESET ACKNOWLEDGE .....	102
3.2.1.25	HANDOVER PERFORMED .....	103
3.2.1.26	OVERLOAD.....	104
3.2.1.27	MSC INVOKE TRACE.....	104
3.2.1.28	BSS INVOKE TRACE .....	104
3.2.1.29	CLASSMARK UPDATE.....	105
3.2.1.30	CIPHER MODE COMMAND.....	105
3.2.1.31	CIPHER MODE COMPLETE.....	105
3.2.1.32	COMPLETE LAYER 3 INFORMATION.....	106
3.2.1.33	QUEUEING INDICATION.....	106
3.2.1.34	SAPI "n" REJECT.....	106
3.2.1.35	(void).....	107
3.2.1.36	(void).....	107
3.2.1.37	HANDOVER REQUIRED REJECT .....	107
3.2.1.38	RESET CIRCUIT .....	107
3.2.1.39	RESET CIRCUIT ACKNOWLEDGE.....	107
3.2.1.40	HANDOVER DETECT .....	108
3.2.1.41	CIRCUIT GROUP BLOCK.....	108
3.2.1.42	CIRCUIT GROUP BLOCKING ACKNOWLEDGE.....	108
3.2.1.43	CIRCUIT GROUP UNBLOCK.....	108
3.2.1.44	CIRCUIT GROUP UNBLOCKING ACKNOWLEDGE .....	109
3.2.1.45	CONFUSION.....	109
3.2.1.46	CLASSMARK REQUEST .....	109
3.2.1.47	UNEQUIPPED CIRCUIT.....	110
3.2.1.48	CIPHER MODE REJECT.....	110
3.2.1.49	LOAD INDICATION .....	110
3.2.1.50	VGCS/VBS SETUP .....	111
3.2.1.51	VGCS/VBS SETUP ACK.....	111
3.2.1.52	VGCS/VBS SETUP REFUSE .....	111
3.2.1.53	VGCS/VBS ASSIGNMENT REQUEST.....	112
3.2.1.54	VGCS/VBS ASSIGNMENT RESULT.....	112
3.2.1.55	VGCS/VBS ASSIGNMENT FAILURE.....	113
3.2.1.56	VGCS/VBS QUEUEING INDICATION.....	113
3.2.1.57	UPLINK REQUEST .....	114
3.2.1.58	UPLINK REQUEST ACKNOWLEDGE .....	114

3.2.1.59	UPLINK REQUEST CONFIRMATION.....	114
3.2.1.59a	UPLINK APPLICATION DATA.....	114
3.2.1.60	UPLINK RELEASE INDICATION.....	115
3.2.1.61	UPLINK REJECT COMMAND.....	115
3.2.1.62	UPLINK RELEASE COMMAND.....	115
3.2.1.63	UPLINK SEIZED COMMAND.....	116
3.2.1.64	SUSPEND.....	116
3.2.1.65	RESUME.....	116
3.2.1.66	CHANGE CIRCUIT.....	116
3.2.1.67	CHANGE CIRCUIT ACKNOWLEDGE.....	117
3.2.1.68	Common ID.....	117
3.2.1.69	LSA INFORMATION.....	117
3.2.1.70	(void).....	118
3.2.1.71	PERFORM LOCATION REQUEST.....	118
3.2.1.72	PERFORM LOCATION RESPONSE.....	118
3.2.1.73	PERFORM LOCATION ABORT.....	118
3.2.1.74	CONNECTIONLESS INFORMATION.....	119
3.2.1.75	CHANNEL MODIFY REQUEST.....	119
3.2.1.76	EMERGENCY RESET INDICATION.....	119
3.2.1.77	EMERGENCY RESET COMMAND.....	119
3.2.1.78	VGCS ADDITIONAL INFORMATION.....	120
3.2.1.79	VGCS/VBS AREA CELL INFO.....	120
3.2.1.80	VGCS/VBS ASSIGNMENT STATUS.....	120
3.2.1.81	VGCS SMS.....	121
3.2.1.82	NOTIFICATION DATA.....	121
3.2.1.83	INTERNAL HANDOVER REQUIRED.....	121
3.2.1.84	INTERNAL HANDOVER REQUIRED REJECT.....	122
3.2.1.85	INTERNAL HANDOVER COMMAND.....	123
3.2.1.86	INTERNAL HANDOVER ENQUIRY.....	123
3.2.1.87	RESET IP RESOURCE.....	123
3.2.1.88	RESET IP RESOURCE ACKNOWLEDGE.....	124
3.2.1.89	REROUTE COMMAND.....	124
3.2.1.90	REROUTE COMPLETE.....	124
3.2.1.91	LCLS-CONNECT-CONTROL.....	124
3.2.1.92	LCLS-CONNECT-CONTROL-ACK.....	125
3.2.1.93	LCLS-NOTIFICATION.....	125
3.2.2	Signalling element coding.....	125
3.2.2.0	General.....	125
3.2.2.1	Message Type.....	129
3.2.2.2	Circuit Identity Code.....	130
3.2.2.3	Connection Release Requested.....	131
3.2.2.4	Resource Available.....	131
3.2.2.5	Cause.....	132
3.2.2.6	IMSI.....	134
3.2.2.7	TMSI.....	135
3.2.2.8	Number Of MSs.....	135
3.2.2.9	Layer 3 Header Information.....	135
3.2.2.10	Encryption Information.....	136
3.2.2.11	Channel Type.....	136
3.2.2.12	Periodicity.....	142
3.2.2.13	Extended Resource Indicator.....	143
3.2.2.14	Total Resource Accessible.....	143
3.2.2.15	LSA Identifier.....	144
3.2.2.16	LSA Identifier List.....	144
3.2.2.17	Cell Identifier.....	145
3.2.2.18	Priority.....	147
3.2.2.19	Classmark Information Type 2.....	148
3.2.2.20	Classmark Information Type 3.....	148
3.2.2.21	Interference Band To Be Used.....	149
3.2.2.22	RR Cause.....	149
3.2.2.23	LSA Information.....	149
3.2.2.24	Layer 3 Information.....	150



3.2.2.25	DLCI .....	150
3.2.2.26	Downlink DTX Flag .....	150
3.2.2.27	Cell Identifier List .....	151
3.2.2.27a	Cell Identifier List Segment .....	154
3.2.2.27b	Cell Identifier List Segment for established cells .....	157
3.2.2.27c	Cell Identifier List Segment for cells to be established .....	159
3.2.2.27d	(void) .....	160
3.2.2.27e	Cell Identifier List Segment for released cells - no user present .....	160
3.2.2.27f	Cell Identifier List Segment for not established cells - no establishment possible .....	160
3.2.2.28	Response Request .....	160
3.2.2.29	Resource Indication Method .....	161
3.2.2.30	Classmark Information Type 1 .....	161
3.2.2.31	Circuit Identity Code List .....	161
3.2.2.32	Diagnostics .....	162
3.2.2.33	Chosen Channel .....	163
3.2.2.34	Cipher Response Mode .....	164
3.2.2.35	Layer 3 Message Contents .....	164
3.2.2.36	Channel Needed .....	165
3.2.2.37	Trace Type .....	165
3.2.2.38	TriggerID .....	165
3.2.2.39	Trace Reference .....	165
3.2.2.40	TransactionID .....	165
3.2.2.41	Mobile Identity .....	166
3.2.2.42	OMCID .....	166
3.2.2.43	Forward Indicator .....	166
3.2.2.44	Chosen Encryption Algorithm .....	166
3.2.2.45	Circuit Pool .....	167
3.2.2.46	Circuit Pool List .....	172
3.2.2.47	Time Indication .....	172
3.2.2.48	Resource Situation .....	172
3.2.2.49	Current Channel Type 1 .....	174
3.2.2.50	Queuing Indicator .....	175
3.2.2.51	Speech Version .....	175
3.2.2.52	Assignment Requirement .....	175
3.2.2.53	(void) .....	176
3.2.2.54	Talker Flag .....	176
3.2.2.55	Group Call Reference .....	176
3.2.2.56	eMLPP Priority .....	176
3.2.2.57	Configuration Evolution Indication .....	176
3.2.2.58	Old BSS to New BSS information .....	177
3.2.2.59	(void) .....	178
3.2.2.60	LCS QoS .....	178
3.2.2.61	LSA Access Control Suppression .....	178
3.2.2.62	LCS Priority .....	178
3.2.2.63	Location Type .....	178
3.2.2.64	Location Estimate .....	179
3.2.2.65	Positioning Data .....	179
3.2.2.66	LCS Cause .....	179
3.2.2.67	LCS Client Type .....	179
3.2.2.68	APDU .....	180
3.2.2.69	Network Element Identity .....	180
3.2.2.70	GPS Assistance Data .....	180
3.2.2.71	Deciphering Keys .....	180
3.2.2.72	Return Error Request .....	181
3.2.2.73	Return Error Cause .....	181
3.2.2.74	Segmentation .....	181
3.2.2.75	Service Handover .....	182
3.2.2.76	Source RNC to target RNC transparent information (UMTS) .....	182
3.2.2.77	Source RNC to target RNC transparent information (cdma2000) .....	182
3.2.2.78	GERAN Classmark .....	183
3.2.2.79	GERAN BSC Container .....	183
3.2.2.80	New BSS to Old BSS Information .....	184

3.2.2.81	Inter-System Information .....	185
3.2.2.82	SNA Access Information .....	185
3.2.2.83	VSTK_RAND Information .....	186
3.2.2.84	VSTK information .....	186
3.2.2.85	Paging Information.....	187
3.2.2.86	IMEI .....	187
3.2.2.87	Velocity Estimate .....	187
3.2.2.88	VGCS Feature Flags .....	188
3.2.2.89	Talker Priority .....	189
3.2.2.90	Emergency Set Indication .....	189
3.2.2.91	Talker Identity .....	189
3.2.2.92	SMS to VGCS .....	190
3.2.2.93	VGCS talker mode .....	190
3.2.2.94	VGCS/VBS Cell Status .....	191
3.2.2.95	GANSS Assistance Data .....	191
3.2.2.96	GANSS Positioning Data .....	191
3.2.2.97	GANSS Location Type .....	192
3.2.2.98	Application Data .....	192
3.2.2.99	Data Identity .....	192
3.2.2.100	Application Data Information .....	192
3.2.2.101	MSISDN .....	193
3.2.2.102	AoIP Transport Layer Address .....	193
3.2.2.103	Speech Codec List.....	193
3.2.2.104	Speech Codec .....	197
3.2.2.105	Call Identifier .....	198
3.2.2.106	Call Identifier List .....	198
3.2.2.107	A-Interface Selector for RESET .....	198
3.2.2.108	(void).....	199
3.2.2.109	Kc <sub>128</sub> .....	199
3.2.2.110	CSG Identifier .....	199
3.2.2.111	Redirect Attempt Flag .....	199
3.2.2.112	Reroute Reject Cause .....	200
3.2.2.113	Send Sequence Number .....	200
3.2.2.114	Reroute complete outcome.....	200
3.2.2.115	Global Call Reference .....	201
3.2.2.116	LCLS-Configuration .....	201
3.2.2.117	LCLS-Connection-Status-Control.....	202
3.2.2.118	LCLS-Correlation-Not-Needed.....	202
3.2.2.119	LCLS-BSS-Status .....	202
3.2.2.120	LCLS-Break-Request.....	203
3.2.2.121	CSFB Indication.....	203
3.2.3	Signalling Field Element Coding .....	203
3.2.3.1	Extra information .....	203
3.2.3.2	Current Channel type 2 .....	204
3.2.3.3	Target cell radio information.....	205
3.2.3.4	GPRS Suspend Information .....	205
3.2.3.5	MultiRate configuration Information .....	206
3.2.3.6	Dual Transfer Mode information .....	206
3.2.3.7	Inter RAT Handover Info.....	206
3.2.3.8	cdma2000 Capability Information .....	207
3.2.3.9	Downlink Cell Load Information.....	207
3.2.3.10	Uplink Cell Load Information.....	207
3.2.3.11	Cell Load Information Group.....	207
3.2.3.12	Cell Load Information.....	208
3.2.3.13	PS Indication .....	208
3.2.3.14	DTM Handover Command Indication .....	209
3.2.3.15	D-RNTI .....	209
3.2.3.16	IRAT Measurement Configuration .....	209
3.2.4	List of Timers in the BSSMAP Procedures .....	211
3.3	SDL Representation Of The Procedures At The BSS .....	211
4	Broadcast Information Control Channel .....	211

5 Definitions .....211

6 List of diagrams.....213

**Annex A (informative): Change History .....224**

History .....225

---

## Foreword

This Technical Specification has been produced by the 3<sup>rd</sup> Generation Partnership Project (3GPP).

The contents of the present document are subject to continuing work within the TSG and may change following formal TSG approval. Should the TSG modify the contents of the present document, it will be re-released by the TSG with an identifying change of release date and an increase in version number as follows:

Version x.y.z

where:

- x the first digit:
  - 1 presented to TSG for information;
  - 2 presented to TSG for approval;
  - 3 or greater indicates TSG approved document under change control.
- y the second digit is incremented for all changes of substance, i.e. technical enhancements, corrections, updates, etc.
- z the third digit is incremented when editorial only changes have been incorporated in the document.

---

# 1 Scope

The present document specifies the layer 3 procedures used on the Base Station System (BSS) to Mobile-services Switching Centre (MSC) interface for control of GSM services.

For the purposes of call control and mobility management, messages are not interpreted at the Base Station System (BSS) which acts as a relay function. These messages and procedures are documented in 3GPP TS 24.008, the only relevant issues covering these messages in the present document are those concerned with error conditions at the interface, and the headers that are required for the correct addressing of the messages. This is specified in more detail in 3GPP TS 48.002.

The functional split between MSC and BSS is defined in 3GPP TS 48.002 and states that the BSS is responsible for local radio resource allocation and in order to support this the required procedures between BSS and MSC are defined in detail in the present document.

3GPP TS 48.002 also states that the BSS is responsible for the scheduling of all CCCH/BCCH messages and therefore some procedures for providing the BSS with the necessary information to be passed on these channels for individual calls (i.e. paging) are defined in the present document, but the scheduling is not discussed.

This interface and consequently these layer 3 procedures are designed to support BSSs providing one or more cells.

## 1.1 References

The following documents contain provisions which, through reference in this text, constitute provisions of the present document.

- References are either specific (identified by date of publication, edition number, version number, etc.) or non-specific.
- For a specific reference, subsequent revisions do not apply.
- For a non-specific reference, the latest version applies. In the case of a reference to a 3GPP document (including a GSM document), a non-specific reference implicitly refers to the latest version of that document *in the same Release as the present document*.

- [1] 3GPP TR 21.905: "Vocabulary for 3GPP Specifications".
- [2] 3GPP TS 23.003: "Numbering, addressing and identification".
- [3] 3GPP TS 23.009: "Handover procedures".
- [3a] 3GPP TS 23.032: "Universal Geographical Area Description (GAD)".
- [4] (void)
- [5] 3GPP TS 43.059: "Functional stage 2 description of Location Services (LCS) in GERAN".
- [6] 3GPP TS 24.008: "Mobile radio interface Layer 3 specification; Core network protocols; Stage 3".
- [7] (void).
- [8] (void).
- [9] (void).
- [10] (void).
- [11] (void).
- [12] (void).
- [13] (void).

- [14] (void).
- [15] (void).
- [16] 3GPP TS 48.002: "Base Station System - Mobile-services Switching Centre (BSS-MSC) interface; Interface principles".
- [17] 3GPP TS 48.006: "Signalling transport mechanism specification for the Base Station System - Mobile-services Switching Centre (BSS-MSC) interface".
- [18] 3GPP TS 48.020: "Rate adaption on the Base Station System - Mobile-services Switching Centre (BSS-MSC) interface".
- [18a] (void).
- [19] 3GPP TS 48.071: "Location Services (LCS); Serving Mobile Location Center - Base Station System (SMLC-BSS) interface; Layer 3 specification".
- [19a] 3GPP TS 49.031: "Location Services (LCS); Base Station System Application Part LCS Extension (BSSAP-LE)".
- [20] (void).
- [21] (void).
- [22] (void).
- [23] (void).
- [24] (void).
- [25] (void).
- [26] (void).
- [27] (void).
- [28] 3GPP TS 52.021: "Network Management (NM) procedures and messages on the A-bis Interface".
- [29] (void).
- [30] (void).
- [31] 3GPP TS 25.413: "UTRAN Iu Interface RANAP signalling".
- [32] 3GPP TS 44.018: "Mobile radio interface layer 3 specification; Radio Resource Control Protocol".
- [33] 3GPP TS 25.331: "Radio Resource Control (RRC) protocol specification".
- [34] (void).
- [35] (void).
- [36] (void).
- [37] ITU-T Recommendation E.164: "The international public telecommunication numbering plan".
- [38] ITU-T Recommendation X.25: "Interface between Data Terminal Equipment (DTE) and Data Circuit-terminating Equipment (DCE) for terminals operating in the packet mode and connected to public data networks by dedicated circuit".
- [39] 3GPP TS 43.020: "Security-related network functions".
- [40] 3GPP TS 43.073: "Support of Localised Service Area (SoLSA); Stage 2".
- [41] 3GPP TS 52.008: "Telecommunication management; GSM subscriber and equipment trace".
- [42] (void).

- [43] 3GPP TS 45.002: "Multiplexing and multiple access on the radio path".
- [44] 3GPP TS 26.103: "Speech codec list for GSM and UMTS".
- [45] 3GPP TS 43.051: "GSM/EDGE Radio Access Network (GERAN) overall description; Stage 2".
- [46] 3GPP TS 23.172: " Technical realization of Circuit Switched (CS) multimedia service UDI/RDI fallback and service modification; Stage 2".
- [47] 3GPP TS 43.068: "Voice Group Call Service (VGCS); Stage 2".
- [48] 3GPP TS 23.236: "Intra-domain connection of Radio Access Network (RAN) nodes to multiple Core Network (CN) nodes".
- [49] 3GPP TS 23.216: "Single Radio Voice Call Continuity (SRVCC); Stage 2".
- [50] 3GPP TS 22.220: "Service Requirements for Home NodeBs and Home eNodeBs".
- [51] 3GPP TS 23.153: 'Out of band transcoder control; Stage 2'.
- [52] 3GPP TS 23.251: "Network sharing - Architecture and functional description".
- [53] 3GPP TS 29.280: "3GPP Sv interface (MME to MSC, and SGSN to MSC) for SRVCC ".
- [54] 3GPP TS 23.284: "Local Call Local Switch; Stage 2".
- [55] 3GPP TS 29.205: "Application of Q.1900 series to bearer independent Circuit Switched (CS) core network architecture; Stage 3".
- [56] 3GPP TS 43.130: "Iur-g interface; Stage 2".
- [57] 3GPP TS 36.413: "S1 Application Protocol (S1AP)".
- [58] 3GPP TS 45.008: "Radio subsystem link control".
- [59] 3GPP TS 36.300: "Evolved Universal Terrestrial Radio Access (E-UTRA) and Evolved Universal Terrestrial Radio Access Network (E-UTRAN); Overall description; Stage 2".

## 1.2 Definitions and Abbreviations

For the purposes of the present document, the definitions and abbreviations given in 3GPP TR 21.905 and the following apply. An abbreviation defined in the present document takes precedence over the definition of the same abbreviation, if any, in TR 21.905.

AoIP	A over IP, using IP as the bearer of the user plane of A interface.
AoTDM	A over TDM, using TDM as the bearer of the user plane of A interface.
CSFB	Circuit Switched Fallback
CSG	Closed Subscriber Group
CSG Cell	A cell for which the reported access mode indicates "Closed access mode" as defined in [50].
EPS	Evolved Packet System
GCR	Global Call Reference
Intra-BSS call	A mobile to mobile voice call involving two mobile stations connected to the same BSS.
LCLS	Local Call Local Switch
Local call	An Intra-BSS call that can be locally switched by the BSS.
Hybrid Cell	A cell for which the reported access mode indicates "Hybrid access Mode" as defined in [50].
MOCN	Multi Operator Core Network as defined in [52].
SRVCC	Single Radio Voice Call Continuity.

---

## 2 Application to interface structures

The underlying transport mechanism defined to carry signalling information between the BSS and the MSC is the Message Transfer Part (MTP), and the Signalling Connection Control Part (SCCP) of Signalling System No.7.

The MTP and SCCP are used to support communication between the MSC and two conceptual entities within the BSS, these are:

- the BSS Operation and Maintenance Application Part (BSSOMAP);
- the BSS Application Part (BSSAP).

The BSS Application Part is split into two sub application parts, these are:

- the BSS Management Application Part (BSSMAP);
- the Direct Transfer Application Part (DTAP).

Distribution of messages between the two sub application parts is described in 3GPP TS 48.002.

Figure 1 is a diagrammatical representation of these conceptual entities. It should be noted that this is not intended to imply a particular implementation and is only for the purposes of specifying the interface.

Differentiation between BSSAP and BSSOMAP is by addressing mechanisms within the SCCP, using the subsystem number (see 3GPP TS 48.002).

## 2.1 The BSS Operation and Maintenance Application Part

If operation and maintenance messages are transferred by means of this interface then they shall use SCCP messages. The application protocol for the Operation and Maintenance Application Part is defined in the 3GPP TS 52 series Technical Specifications. The routing and addressing is provided by the SCCP and allows the MSC and the O&M centre to be addressed directly by the BSS using, for example, two E.164 numbers. The operator may also use an X.25 connection for the transfer of O&M messages between the BSS and the OMC. This option is not further discussed in the present document.

## 2.2 The Direct Transfer Application Part

The Direct Transfer Application Part (DTAP) is used to transfer call control and mobility management messages between the MSC and the MS. The DTAP information in these messages is not interpreted by the BSS. 3GPP TS 48.002 contains more detail relating to the handling of DTAP messages at the BSS, the multiplexing of the messages onto the relevant signalling channels of the radio interface, and the use of the SCCP services.

Messages received from the MS are identified as DTAP by the Protocol Discriminator Information Element as described in 3GPP TS 24.008, except for Initial Layer 3 messages (see sub-clause 3.1.16). The majority of radio interface messages are transferred across the BSS MSC interface by the DTAP, the exceptions being messages belonging to the Radio Resource (RR) management protocol.

## 2.3 The BSS Management Application Part

The BSSMAP supports all of the procedures between the MSC and the BSS that require interpretation and processing of information related to single calls, and resource management.

Some of the BSSMAP procedures result in, or are triggered by, Radio Resource (RR) management messages defined in 3GPP TS 24.008. The BSSMAP procedures are described in sub-clause 3.

## 2.4 Handling of abnormal events related to the BSSAP Header

The BSSAP header is specified in 3GPP TS 48.002. Several abnormal events may be detected by the receiver:

- use of a reserved value in the DLCI or discriminator;
- length octet with value zero;
- length octet with a value inconsistent with that indicated by the SCCP.



In these cases the receiver may send a BSSMAP CONFUSION message as specified in sub-clause 3.2.1. If so, depending on the error in the BSSAP header, the error pointer shall be set to one of the values reserved for the BSSAP header in sub-clause 3.2.2.32.

Spare bits in the BSSAP header shall not be checked by the receiving entity.

## 3 The BSS Management Application Part

### 3.1 BSSMAP Procedures

This sub-clause describes the procedures used in the BSS Management Application Part. There are the following main procedures:

*	Assignment	figure 2
#	Blocking	figures 10 and 25
#	Resource indication	figure 12
#	Reset	figure 11
*	Handover required indication	figure 4
*	Handover resource allocation	figure 5
*	Handover execution	figure 3
#	Handover candidate enquiry	figure 13
*	Release	figures 6 and 7
#	Paging	figure 15
#	Flow control	figure 14
*	Classmark update	figure 9
*	Cipher mode control	figure 17
*	Trace invocation	
*	Initial MS message	
*	Queuing indication	
*	Data link control SAPI not equal to 0	figure 18
#	Reset circuit	
*	PDSS1 flow control	
*	Circuit re-selection	figure 26
*	Location Acquisition	
#	Connectionless Information Transfer	
*	Common ID	
#	Reset IP Resource	

These procedures are documented separately and are intended to be used by the operators/manufacturers to build up complete call sequences, in a flexible manner. Any sequences given where more than one procedure is shown concatenated are only for illustrative purposes.

Each of the above procedures is qualified by either an asterisk (\*) or a hash symbol (#). The hash symbol (#) denotes a global procedure which concerns a complete cell or BSS, or specific terrestrial circuits. The asterisk symbol (\*) denotes a dedicated procedure which concerns a single dedicated radio resource on the radio interface, or in the case of a multislot configuration, all radio resources allocated to one mobile station.

Messages used to support global procedures are sent using the connectionless services of the SCCP.

Messages used to support dedicated procedures are sent using the connection oriented services of the SCCP, on the connection which has been set up to support that call or transaction. The establishment of SCCP connections is detailed in 3GPP TS 48.002.

In the following description of each procedure it is explicitly stated whether the procedure is global or not, and hence the type of SCCP service used to support the procedure is defined.

The handling of unknown terrestrial circuits is defined in sub-clause 3.1.19.6 and the procedures of sub-clause 3.1.19.6 take precedence over those of the rest of sub-clause 3.1. The procedures of the rest of sub-clause 3.1 assume that the terrestrial circuit is known by the entity concerned.

### 3.1.1 Assignment

The purpose of the assignment procedure is to ensure that the correct dedicated radio resource(s) can be allocated or reallocated to a MS that requires it. However, the initial random access by the MS and "Immediate Assignment" to a DCCH is handled autonomously by the BSS without reference to the MSC.

#### 3.1.1.1 Successful Operation

The initial conditions are assumed to be that the MS is in contact with the fixed infrastructure of a PLMN by means of one or more dedicated radio resources (and possibly a terrestrial resource) and that the MSC has analysed any relevant call control information and wishes to allocate or reallocate to the MS one or more radio resources (and possibly a terrestrial resource).

The MSC is the entity that carries out the necessary analysis on the call control information received from the MS or fixed network customer. If an IP based user plane interface is supported, the Codec List (BSS supported) shall be taken into account, considering the Codec capabilities of the core network, aiming for true end-to-end Codec negotiation and for common supported Codec(s).

If an IP based user plane interface is supported, then the MSC shall consider the CSData Codec Type within the Codec List (BSS supported) for data and fax calls. The purpose of the CSData Codec Type negotiation is to determine the A-Interface Type (TDM or IP) and the Redundancy Level (option only for IP). The Redundancy Level affects only the A-Interface IP link and not the air interface. For data and fax call, there is no end-to-end negotiation of this CSData Codec Type. The Codec negotiation just happens between the BSS and the MSC.

On the basis of this analysis a resource request is made to the appropriate BSS by sending it an ASSIGNMENT REQUEST message. This message contains details of the resource(s) required (for instance channel rate, channel type, data adaptation, priority level etc.). If the requested resource(s) is/are for speech or data it also may indicate the terrestrial resource that shall be used between the MSC and BSS. The description of the resource(s) can either be a complete specification, or give the BSS some freedom in the selection (for instance channel rate selection, speech version, Codec Type and Codec Configuration selection, Interface Type selection, Redundancy Level selection, etc.). If an IP based user plane interface is supported, the Codec List (MSC Preferred), see subclause 3.2.2.103, shall be included in the ASSIGNMENT REQUEST message. The ASSIGNMENT REQUEST message may also contain CLASSMARK information in case such information is available in the MSC, but assumed not to be available in the BSS. A full description of the message is given in sub-clause 3.2.1.1.

In this specification a "pool" is a group of circuits supporting the same channel types.

The ASSIGNMENT REQUEST message is sent via the BSSMAP and is analysed within the BSS. Based on this analysis, which is not defined further in the present document, the BSS chooses the appropriate radio resource(s) and allocates the appropriate resources for transcoding, rate adaptation etc. On the terrestrial route connecting the BSS and MSC, certain circuits can be used for different combinations of bearer capabilities. This can be modelled by grouping the circuits into "pools" supporting the same channel types. The MSC holds this information as route data. If the MSC allocates an A interface circuit, it should only ever ask for resources from the BSS that it knows are not totally incompatible with the nominated circuit. The BSS will construct and send the appropriate radio assignment messages, if required (i.e. if the radio resource(s) has/have to be changed), as described in 3GPP TS 44.018 and start timer T10. The ASSIGNMENT REQUEST message includes sufficient information to allow the BSS to construct the necessary layer 3 radio messages. If the BSS allocates the A interface circuits, and such a circuit is needed, the BSS shall allocate a circuit.

In the case where several circuit pools (groups of circuits supporting the same channel types) are available on the BSS MSC interface, the terrestrial circuit allocated by the MSC, if any, is chosen taking into account the circuit pool the circuit belongs to and the required channel type.

The management of priority levels is implementation dependent, under operator control.

If queuing is managed, new requests which cannot be served immediately are put in the queuing file according to the indicated priority levels.

The priority levels and the preemption indicators may (singularly or in combination) be used to determine whether the assignment has to be performed unconditionally and immediately. This would lead to triggering of the preemption procedure which may then cause the forced release or forced handover of a lower priority connection if no free resource is immediately available.

Whilst the process and the extent of the preemption procedure is operator dependent, the preemption indicators (refer to sub-clause 3.2.2.18.), if given in the ASSIGNMENT REQUEST, shall be treated on a per connection basis as follows:

- The last received "Preemption Vulnerability indicator" and priority levels shall prevail.
- If the "Preemption Capability indicator" bit is set to 1, then this allocation request can trigger the running of the preemption procedure.
- If the "Preemption Capability indicator" bit is set to 0, then this allocation request cannot trigger the preemption procedure.
- If the "Preemption Vulnerability" bit is set to 1, then this connection is vulnerable and shall be included in the preemption process or procedure and as such may be subject to forced release or forced handover.
- If the "Preemption Vulnerability" bit is set to 0, then this connection is not vulnerable to preemption and shall not be included in the preemption process and as such may not be subject to forced release or forced handover.
- If no priority Information Element has been received, both "Preemption Capability" and "Preemption Vulnerability" bits shall be regarded as set to 0.

The BSS shall ignore the classmark information included in the ASSIGNMENT REQUEST message if such information has already been received from the MS.

The radio assignment procedure on the radio path is described in 3GPP TS 44.018. When the BSS is satisfied that the radio assignment procedure has been successfully accomplished (e.g. by receipt of a radio interface ASSIGNMENT COMPLETE message) it will stop timer T10 and return an ASSIGNMENT COMPLETE message over the BSS MSC interface. This will implicitly release the old dedicated radio resource(s) at the BSS. If an intra-BSS cell change has occurred during the assignment, the new cell identity is included in the ASSIGNMENT COMPLETE message and a HANDOVER PERFORMED message is not required. If the MSC gave the BSS some freedom in resource type selection, the choices made by the BSS are indicated in the ASSIGNMENT COMPLETE message. If an IP based user plane interface is supported, the "Speech Codec (Chosen)" shall be included in the ASSIGNMENT COMPLETE message. If the BSS has to allocate a circuit or an IP based user plane connection, the ASSIGNMENT COMPLETE message includes the identity of the circuit or the local IP endpoint included in the "AoIP Transport Layer Address" allocated by the BSS.

If an IP based user plane interface is supported, the BSC should preferentially accept the preferred codec proposed by the MSC; the selection of an alternative codec may entail transcoding in the Network.

When several circuit pools are present on the BSS MSC interface, and when the circuit is allocated by the MSC, the "circuit pool" information element shall be included in the ASSIGNMENT COMPLETE. The "circuit pool" field will indicate to the MSC the circuit pool of the CIC given in the ASSIGNMENT REQUEST message.

If the assignment did not require a change of radio resource(s), and consequently no 3GPP TS 44.018 radio assignment procedure had been invoked, then the ASSIGNMENT COMPLETE message shall be returned to the MSC as soon as the requested resources have been allocated within the BSS.

If the assignment requires a change of terrestrial circuit or in the case of assignment for signalling the release of a previously used terrestrial circuit, the change or release shall be performed before the ASSIGNMENT COMPLETE message is sent and the BSS shall consider that the old terrestrial circuit is idle.

After the completion of the assignment procedure, until the connection is released or the MSC performs a new assignment, any dedicated resource assigned to the mobile station, e.g. at internal handover, must be in accordance with the description in the ASSIGNMENT REQUEST message.

If the MS is a talker or listener in a voice group call, the MSC shall inform the BSS to which voice group call the MS belongs to and whether the MS is a talker or a listener. The BSS may then decide to allocate and assign dedicated channel or move the MS to a voice group call channel relating to the group call reference. If the BSS moves the MS to a voice group call channel it will send the ASSIGNMENT COMPLETE message and then immediately afterwards send a CLEAR REQUEST cause "Joined group call channel". If the assignment procedure is used to transfer the talker from a group call channel to a dedicated channel and the ASSIGNMENT REQUEST message contains a Group Call Reference IE with group key number other than 'no ciphering', the MSC shall provide the BSS with the permitted ciphering algorithms and the ciphering key to use in case the BSS assigns a dedicated channel.

In the case where localised service area is supported the MSC may inform the BSS as to which LSA identities that the mobile has preferences by sending the LSA INFORMATION message. The BSS stores this information and uses it when determining the target cell list for handover. The algorithm for determining the target cell list for handover is not defined further in the present document. The reception of another message containing LSA identities for the connection will replace the LSA identities previously received. The BSS, in the case where localised service area is supported, will indicate the LSA identity of the serving cell in the ASSIGNMENT COMPLETE if it corresponds to one of the LSA identities received in the latest LSA INFORMATION or the HANDOVER REQUEST messages.

In the case where Intersystem handover to other RAT's is supported, the MSC may inform the BSS, if preference for other radio access technologies (Service based handover) shall be applied to the MS connection. In such cases the MSC sets the Service Handover Information Element accordingly in the ASSIGNMENT REQUEST message. The Service Handover information is stored in the BSS throughout the connection and is used in the Handover evaluation process.

If the Service Handover information element indicates that "handover to UTRAN or cdma2000 should be performed", the BSS should perform an Intersystem handover via directed retry instead of the assignment. If this is not possible, the BSS shall proceed with the assignment procedure as specified above.

NOTE 1: If, due to limitations of the mobile station or the network it is attached to, the service requested by the subscriber cannot be provided in GSM, but by another RAT, then the MSC may include in the ASSIGNMENT REQUEST message a Service Handover information element indicating that "handover to UTRAN or cdma2000 should be performed" and the required channel type coded according to NOTE 4 in subclause 3.2.2.11. The MSC may under these circumstances omit allocating a terrestrial circuit. In such a case, if the BSC cannot initiate a directed retry, the assignment will fail.

If local switching is requested by the core network, the MSC includes the Global Call Reference IE, LCLS-Configuration IE, and optionally the LCLS-Connection-Status-Control IE and the LCLS-Correlation-Not-Needed IE in the ASSIGNMENT REQUEST message.

If the BSS supports Local Call Local Switch (LCLS) and receives the ASSIGNMENT REQUEST message containing the Global Call Reference IE and the LCLS-Configuration IE, then the BSS shall store the Global Call Reference (GCR) value (or replace the previously stored GCR value) and check if the requested LCLS configuration included in the LCLS-Configuration IE is supported.

- If the requested LCLS configuration is not supported, then the BSS shall indicate this to the MSC in the LCLS-BSS-Status IE included in the ASSIGNMENT COMPLETE message, see sub-clause 3.1.33.2.3.
- If the BSS supports the requested LCLS configuration, then the BSS shall perform call leg correlation as described in sub-clause 3.1.33.2.1 and report the outcome to the MSC in LCLS-BSS-Status IE included in the ASSIGNMENT COMPLETE message.

If BSS determines that the call is an intra-BSS call and therefore can be locally switched it shall not through-connect the two parties unless explicitly indicated to do so in the ASSIGNMENT REQUEST message by receiving the LCLS-Connection-Status-Control IE set to "Connect" on both call legs.

NOTE 2: If not included in the ASSIGNMENT REQUEST message, the LCLS-Connection-Status-Control IE may be received in the LCLS-CONNECT-CONTROL message after completion of the assignment procedure.

The BSS shall inform the MSC of the local switch establishment outcome by including the LCLS-BSS-Status IE with the correct LCLS connection status value according to sub-clause 3.2.2.119 in the ASSIGNMENT COMPLETE message. The BSS shall also notify the MSC serving the other call leg if the LCLS connection status is changed for this call leg, see sub-clause 3.1.33.5.

NOTE 3: If the BSS does not support LCLS then the Global Call Reference IE and the LCLS-Configuration IE in the ASSIGNMENT REQUEST message will be ignored by the BSS and no LCLS-BSS-Status IE will be returned in the ASSIGNMENT COMPLETE message.

### 3.1.1.2 Assignment Failure

The following failure conditions may occur:

The BSS may not be able to use the terrestrial resource that the MSC has indicated in which case an ASSIGNMENT FAILURE message will be returned to the MSC with the cause set to "requested terrestrial resource unavailable".

The BSS may not be able to support any of the permitted ciphering algorithms. In this case a ASSIGNMENT FAILURE message shall be returned to the MSC with the failure cause set to "ciphering algorithm not supported".

If the requested channel type or resource (e.g. channel rate, speech version, Codec Type or Codec Configuration, Redundancy Level, A-Interface Type, etc.) indicated in the ASSIGNMENT REQUEST message is not temporarily available (e.g. due to overload) or not supported in the BSS, then an ASSIGNMENT FAILURE message shall be returned to the MSC. The appropriate failure cause will be included in the message (Cause value: "requested transcoding/rate adaptation unavailable" or "requested speech version unavailable" or "Requested Codec Type or Codec Configuration unavailable" or "Requested Redundancy Level not supported" or "Requested Redundancy Level not available" or "Requested Codec Type or Codec Configuration not supported" or "Requested A-Interface Type unavailable" or "Requested A-Interface Type not supported").

If the MSC requested an IP-bearer for the A-Interface by providing the AoIP Transport Layer Address and not providing a Circuit Identity Code, but the BSS is not able to use an IP-bearer, then the BSS shall not allocate a Circuit Identity Code on its own, even if the Codec List (MSC Preferred) included a Codec Type with the PT bit set to "1", but shall return an ASSIGNMENT FAILURE message to the MSC with the Cause value "Requested A-Interface Type unavailable".

If, on reception by the BSS of an ASSIGNMENT REQUEST message allocating a circuit, the circuit pool implied by the CIC information element is incompatible with the channel type indicated (that is, the pool does not support any of the radio resources indicated by the channel type) an ASSIGNMENT FAILURE shall be returned to the MSC with the failure cause set to "circuit pool mismatch".

If, on reception by the BSS of an ASSIGNMENT REQUEST message modifying an already allocated circuit, the circuit pool implied by the CIC information element is incompatible with the channel type indicated (that is, the pool does not support any of the radio resources indicated by the channel type) the BSS shall return to the MSC either :

- an ASSIGNMENT FAILURE message with the failure cause set to "circuit pool mismatch", or
- an ASSIGNMENT FAILURE message with the failure cause "directed retry" before sending a HANDOVER REQUIRED message with the cause "switch circuit pool" and the "circuit pool list" information element . The "circuit pool list" information element will allow the BSS to indicate to the MSC from which circuit pool or pools the new CIC should be chosen, or
- a HANDOVER REQUIRED message with the cause "switch circuit pool" and the "circuit pool list" information element . The "circuit pool list" information element will allow the BSS to indicate to the MSC from which circuit pool or pools the new CIC should be chosen.

If, on reception by the BSS of an ASSIGNMENT REQUEST message allocating a circuit, the circuit pool implied by the CIC is compatible with the channel type indicated (that is, the pool supports at least one of the radio resource types indicated by the channel type), but the BSS still wishes to change the circuit pool, it sends an ASSIGNMENT FAILURE with the cause "switch circuit pool" and the "circuit pool list" information element.

The "circuit pool" information element, when present in the ASSIGNMENT FAILURE, indicates to the MSC which circuit pool the CIC indicated in the ASSIGNMENT REQUEST belongs to. This can be used by the MSC to correct its tables (CIC/circuit pool). The "circuit pool list" information element, when present in the ASSIGNMENT FAILURE, is used when the BSS wishes to indicate to the MSC its preferred circuit pools. The circuit pools in the "circuit pool list" information element shall be given in order of preference. In the case of an ASSIGNMENT FAILURE with the cause "circuit pool mismatch", the MSC may decide to block the circuit and to send an O & M notification.

The BSS may not receive a radio interface ASSIGNMENT COMPLETE message from the MS in which case the timer T10 will expire. In this case an ASSIGNMENT FAILURE message is returned to the MSC and the assignment procedure is terminated (cause value: radio interface message failure).

If the cell for which the assignment is intended is congested or in case of a Service Handover indication received from the MSC, the BSS may indicate an impending directed retry attempt by sending ASSIGNMENT FAILURE (Cause value: directed retry).

If the radio channel assignment fails for any other reason then an ASSIGNMENT FAILURE message will be returned to the MSC, the procedure will terminate, and the associated references concerning the old dedicated resource(s) should be maintained until explicitly released by the MSC. It should be noted that if the MS fails to assign after receiving a radio interface ASSIGNMENT COMMAND and returns to the old channels as detailed in 3GPP TS 24.008, then the radio interface ASSIGNMENT FAILURE message received from the MS will cause an ASSIGNMENT FAILURE message to be returned to the MSC (cause value: "Radio interface failure, reversion to old channel").

If the BSS has received LSA INFORMATION or HANDOVER REQUEST message indicating LSA only access and all available radio resources are outside the allowed LSAs, assignment may fail and ASSIGNMENT FAILURE message may be sent to the MSC (cause value: "LSA not allowed").

If all available radio resources are defined for exclusive access and the connection is not allowed to access these resources, assignment may fail and ASSIGNMENT FAILURE message may be sent to the MSC (cause value: "LSA not allowed").

Other possible Cause values which may be returned with the ASSIGNMENT FAILURE message are: "equipment failure", "no radio resource available", "O&M intervention". If an unrecognised cause value is received, the Class of the cause value should be used to determine the MSC's action.

In the case where the MSC has attempted to assign a terrestrial circuit and an ASSIGNMENT FAILURE message has been returned then both the MSC and the BSS shall consider that the terrestrial circuit is idle (except as described below in sub-clause 3.1.1.3) and therefore no explicit clearing sequence is needed.

The MSC may not be able to use the terrestrial resource that the BSS has indicated. In this case, the procedure is nevertheless considered terminated successfully, and it is up to the MSC to correct the situation, e.g. by a circuit re-selection procedure (not relevant for an IP based user plane interface).

All messages concerned with an assignment are sent using the connection oriented mode of the SCCP.

### 3.1.1.3 Abnormal Conditions

If the BSS receives an ASSIGNMENT REQUEST message calling up a terrestrial circuit for the user plane interface that is already assigned to another call then an ASSIGNMENT FAILURE message will be returned with a Cause value of: "terrestrial circuit already allocated" and no action will be taken on the radio interface.

If the BSS receives an ASSIGNMENT REQUEST message allocating a terrestrial circuit which has been blocked by a global block message, then an ASSIGNMENT FAILURE message shall be sent (Cause value: "requested terrestrial resource unavailable"). A single global BLOCK message (not repeated and not guarded by timer T1) shall be sent for that concerned terrestrial circuit.

If an external handover becomes necessary during an assignment, for reasons of radio conditions, congestion or following the reception of a Service Handover indication from the MSC, the BSS may initiate the handover (directed retry) whilst the assignment is in progress. In this situation, if a HANDOVER COMMAND is received by the BSS, it must not be ignored.

## 3.1.2 Blocking and Unblocking

The Blocking and Unblocking procedures are not applied for an IP based user plane interface.

As described in sub-clause 3.1.1 the assignment procedure depends upon one side, the MSC or the BSS, choosing the terrestrial resource to be used. If the entity on one side puts out of service any terrestrial circuit, it needs to inform the peer entity on the other side of the interface. This is performed by using a simple blocking/unblocking procedure. The block messages used to support this procedure are sent as global messages (i.e. using the SCCP connectionless mode). Each message refers to one or more terrestrial circuits accessed through the BSS MSC interface. The circuit is identified by its Circuit Identity Code.

The support of blocking/unblocking procedures is dependent on which side allocates the circuits.

A circuit is said to be "locally blocked" on a given side if it has been put out of service for a local reason, and to be "remotely blocked" if a BLOCK message about this circuit has been received from the peer entity.

### 3.1.2.1 Successful Operation

The procedure operates as follows:

Initial conditions are assumed to be that all circuits are remotely unblocked.

An entity may locally block a terrestrial circuit because:

- Operation and Maintenance intervention makes the circuit unavailable for use (Cause value: "O and M intervention").
- An equipment failure makes the circuit unavailable (Cause value: "equipment failure").
- Radio resource is not accessible from the terrestrial circuit (Cause value: "no radio resource available").

When and if the party that does not allocate the circuits (the Circuit Slave) decides to locally block a terrestrial circuit, it shall immediately mark that terrestrial circuit as "blocked" (to stop any future allocation of that terrestrial circuit) and shall then send a block message to the peer entity allocating the circuits (the Circuit Master) and start timer T1 (T20, T21, T22).

The BLOCK message contains the Circuit Identity Code indicating the terrestrial circuit that is to be remotely blocked and a Cause Information Element indicating the reason for blocking. Typical Cause values are: "no radio resources available", "O and M intervention", "equipment failure".

A BLOCK message in the MSC to BSS direction may also contain an indication that the connection using the circuit, if any, must be released; in such a case the circuit master shall check if the circuit is in use and shall release the connection(s) that use it.

NOTE: This allows the MSC to simultaneously block the circuit and to release the connection(s) using the circuit, if any, and then to prevent use of the circuit by the BSS between connection(s) release and blocking.

If the CIRCUIT GROUP BLOCK message is applied by the circuit slave the circuits to be remotely blocked are indicated in the status field of the Circuit Identity Code List (sub-clause 3.2.2.31).

Receipt of a block message (BLOCK or CIRCUIT GROUP BLOCK) at the circuit master from the circuit slave will indicate to the circuit master that the identified circuits are unavailable for reselection. If a call is in progress on any of the identified terrestrial circuits then it will be unaffected by this procedure unless explicitly requested, the circuits will however be "camp on blocked". Such circuits shall be remotely blocked as soon as that call is no longer in progress, or active.

On receipt of a BLOCK message asking for the release of the connection(s) using the circuit if any, and if the BSS detects that there exists a connection using the indicated circuit, the BSS shall attempt to release the connection(s), e.g., by sending a CLEAR REQUEST message on each of the corresponding SCCP connections. As specified in sub-clause 3.1.17, if the SCCP connection has been lost, the BSS will detect it when attempting to release the connection and the whole connection is released as a consequence.

An appropriate blocking acknowledge message (BLOCKING ACKNOWLEDGE or CIRCUIT GROUP BLOCKING ACKNOWLEDGE) will be returned to the circuit slave by the circuit master to acknowledge receipt of the block message and to indicate that any necessary action has been taken.

The CIRCUIT GROUP BLOCKING ACKNOWLEDGEMENT message is accepted as the appropriate acknowledgement only if the indicated Circuit Identity Code and the returned Range field of the Circuit Identity Code List match the corresponding parameter values of the respective initiating message. Otherwise the message is considered as not expected.

On receipt of the blocking acknowledge the circuit slave shall stop timer T1 (T20, T21, T22).

The resource involved will be assumed to be remotely blocked by the circuit master until either an unblock (UNBLOCK or CIRCUIT GROUP UNBLOCK) or RESET message is received relevant to that resource.

If the circuit slave wishes to unblock a blocked circuit and return it to service then it shall immediately mark the circuit as "locally unblocked" and then send an unblock message, and start timer T1 (T20, T21, T22).

If an unblock message (UNBLOCK or CIRCUIT GROUP UNBLOCK) is received at the circuit master for a blocked resource then the resource will be marked as not remotely blocked and an unblocking acknowledge message (UNBLOCKING ACKNOWLEDGE or CIRCUIT GROUP UNBLOCKING ACKNOWLEDGE) will be returned to the circuit slave. The circuit slave shall stop timer T1 (T20, T21, T22) on receipt of this unblocking acknowledge.

The CIRCUIT GROUP UNBLOCKING ACKNOWLEDGEMENT message is accepted as the appropriate acknowledgement only if the indicated Circuit Identity Code and the returned Range field of the Circuit Identity Code List match the corresponding parameter values of the respective initiating message. Otherwise the message is considered as not expected.

Figure 10 shows an overview of the blocking procedure in the case the circuit slave is the BSS.

NOTE: Timer T1 is used to supervise a single circuit block/unblock procedure on the BSS side, whilst T20 is used to supervise the circuit group block/unblock procedure on the BSS side, timer T21 is used to supervise a single circuit block/unblock procedure on the MSC side, and T22 is used to supervise the circuit group block/unblock procedure on the MSC side.

### 3.1.2.2 Abnormal Conditions

If a blocking acknowledge message is not received for a block message within T1 (T20, T21, T22) seconds then the block message will be repeated. If this occurs a second time the circuits will be kept marked as locally blocked, and the situation must then be resolved internally within the circuit slave or by O&M procedures.

If an unblocking acknowledge message is not received for an unblock message before expiry of timer T1 (T20, T21, T22) then the unblock message will be repeated. If this occurs a second time, this situation may be reflected to the O&M, which shall resolve the possible conflict. The unblock message is repeated at most one time. Whatever the outcome of possible repetitions, the concerned circuits remain locally "unblocked".

If the MSC allocates the circuits, and an ASSIGNMENT REQUEST or HANDOVER REQUEST message is received by the BSS allocating a circuit which is marked at the BSS as blocked then an ASSIGNMENT FAILURE message or a HANDOVER FAILURE message (respectively) followed by a BLOCK message shall be sent to the MSC.

If the BSS allocates the circuits, and an ASSIGNMENT COMPLETE, HANDOVER REQUEST ACKNOWLEDGE or CHANGE CIRCUIT ACKNOWLEDGE message is received by the MSC allocating a circuit which is marked at the MSC as blocked, it is up to the MSC how to correct the situation, e.g., by performing a circuit re-selection procedure and sending a BLOCK message.

#### 3.1.2.2.1 Applying to the Single Circuit Block Procedure

- i) If a BLOCK message is received for a circuit already remotely blocked, a BLOCKING ACKNOWLEDGE message will be sent.
- ii) If an UNBLOCK message is received for a remotely unblocked circuit, an UNBLOCKING ACKNOWLEDGE message will be sent.
- iii) If a BLOCKING ACKNOWLEDGE message, which is not expected as an acknowledgement for a BLOCK message, is received:
  - a) Relating to a circuit which is locally blocked, the BLOCKING ACKNOWLEDGE message is discarded.
  - b) Relating to a circuit, which is not locally blocked, then an UNBLOCK message will be sent.
- iv) If an UNBLOCKING ACKNOWLEDGE message, which is not expected as an acknowledgement for an UNBLOCK message, is received:
  - a) Relating to a circuit which is not locally blocked, the received UNBLOCKING ACKNOWLEDGE message is discarded.
  - b) Relating to a circuit, which is locally blocked, then a BLOCK message will be sent.

#### 3.1.2.2.2 Applying to the Circuit Group Block Procedure

- v) If a CIRCUIT GROUP BLOCK message is received relating to remotely blocked circuits then blocking acknowledgement indications for those circuits are given in the status field of the corresponding CIRCUIT GROUP BLOCKING ACKNOWLEDGE message which will be sent in response.
- vi) If a CIRCUIT GROUP UNBLOCK message is received relating to circuits which are not remotely blocked then unblocking acknowledgement indications for those circuits are given in the status field of the corresponding CIRCUIT GROUP UNBLOCKING ACKNOWLEDGE message which will be sent in response.
- vii) When the circuit master upon receipt of a CIRCUIT GROUP BLOCK (UNBLOCK) message is not able to give an appropriate blocking (unblocking) acknowledgement indication for each Circuit Identification Code (e.g. because that/those Circuit Identification Code(s) is (are) not allocated to any circuit at the receiving entity) for which a block (unblock) indication is given in the status field of the received CIRCUIT GROUP BLOCK



(UNBLOCK) message, then no blocking (unblocking) acknowledgement relating to that/those Circuit Identification Code(s) will be given in the status field of the corresponding CIRCUIT GROUP BLOCKING (UNBLOCKING) ACKNOWLEDGE message which will be sent in response.

- viii) If a CIRCUIT GROUP BLOCKING ACKNOWLEDGE message in response to a CIRCUIT GROUP BLOCK message is received by the circuit slave containing in the status field no blocking acknowledgement for circuits which are to be blocked due to the previously sent CIRCUIT GROUP BLOCK message, then the CIRCUIT GROUP BLOCK message will be repeated for the circuit(s) concerned.

If this occurs a second time the concerned circuit(s) will be kept marked as locally blocked, and the situation must then be resolved internally within the circuit slave or by O&M procedures.

- ix) The same rule applies to the Circuit Group Unblocking procedure with the only difference that the involved terrestrial circuits are kept marked as locally "not blocked".
- x) If a CIRCUIT GROUP BLOCKING ACKNOWLEDGE message in response to a CIRCUIT GROUP BLOCK message is received by the circuit slave containing in the status field blocking acknowledgement indications for circuits which are not to be blocked, then an appropriate unblock message will be sent for the circuit(s) concerned.
- xi) If a CIRCUIT GROUP UNBLOCKING ACKNOWLEDGE message in response to a CIRCUIT GROUP UNBLOCK message is received by the circuit slave containing in the status field unblocking acknowledgement indications for circuits which have to remain marked as locally blocked then an appropriate block message will be sent for the circuit(s) concerned.
- xii) If a CIRCUIT GROUP BLOCKING ACKNOWLEDGE message which is not expected and not accepted as an acknowledgement for a CIRCUIT GROUP BLOCK message is received:
- a) relating to circuits which all are in the status locally blocked, then the received CIRCUIT GROUP BLOCKING ACKNOWLEDGE message will be discarded;
  - b) related to circuits part or all of which are not in the status locally blocked then an appropriate unblock message will be sent for the relevant circuit(s).
- xiii) If a CIRCUIT GROUP UNBLOCKING ACKNOWLEDGE message which is not expected and not accepted as an acknowledgement for a CIRCUIT GROUP UNBLOCK message is received:
- a) relating to circuits none of which is in the status locally blocked, then the received CIRCUIT GROUP UNBLOCKING ACKNOWLEDGE message will be discarded;
  - b) related to circuits part or all of which are locally blocked then an appropriate block message will be sent for the relevant circuit(s).

### 3.1.3 Resource Indication

The purpose of the resource indication procedure is:

- To inform the MSC of the amount:
  - of radio resource that is spare at the BSS and available for traffic carrying purposes; and
  - of the total amount of the accessible radio resource (i.e. available for service or currently assigned).

This cannot easily be derived from the traffic that the MSC is carrying. The MSC may take these pieces of information into account for the external handover decision.

### 3.1.3.1 Successful Operation

The procedure relates to a single cell.

The MSC determines the resource information (i.e. the resource available information and optionally the total resource accessible information) and the manner in which the BSS transfers this resource information to the MSC by sending a RESOURCE REQUEST message to the BSS. This message shall contain a Resource Indication Method Information Element which can be set to one of the following values:

- i) (Spontaneous resource information expected): The BSS shall send the first RESOURCE INDICATION message without any resource information to the MSC immediately as an acknowledgement to the RESOURCE REQUEST message and then any further RESOURCE INDICATION messages spontaneously every time conditions, defined by O&M, are met in the BSS for the considered cell (e.g. traffic thresholds, or time interval between two messages). If the O&M conditions for sending RESOURCE INDICATION messages are met, the BSS may use the Periodicity IE received in the RESOURCE REQUEST message to determine the time interval between indications, except that, if the MSC sets the Periodicity IE to zero then the BSS shall ignore the Periodicity IE. The BSS stays in this mode until the receipt of a new RESOURCE REQUEST message for the same cell, or a reset occurs.
  - ii) (One single resource information expected): The BSS shall return a single RESOURCE INDICATION message with some resource information immediately. If the RESOURCE REQUEST message does not contain an Extended Resource indicator IE the BSS shall then cease any resource information transfer related to the cell until the receipt of either a new RESOURCE REQUEST message or a reset. If the RESOURCE REQUEST message contains an Extended Resource Indicator IE the BSS shall obey the 'Subsequent Mode' field.
  - iii) (Periodic resource information expected): The BSS shall return a RESOURCE INDICATION message with some resource information immediately, and then periodically, with a period set by MSC (note), until the receipt of either a new RESOURCE REQUEST message for the same cell or a reset.
- NOTE: (The period shall equal the value of the periodicity parameter times 100 ms. If the value of the periodicity parameter is zero, then the message should be treated as one containing an incorrect value according to sub-clause 3.1.19.4, case 2.)
- iv) (No resource information expected): The BSS shall immediately return a single RESOURCE INDICATION message without any resource information as an acknowledgement to the RESOURCE REQUEST message and then the BSS to MSC transfer of resource information related to the cell is disabled until the receipt of either a new RESOURCE REQUEST message for the same cell or a reset.

The default mode is iv); after a reset, this mode is set for all the cells of a BSS.

The transfer of resource information related to a given cell from the BSS to the MSC occurs when the Resource Indication Method Information Element is set to one of the values i) to iii) in the BSS. The BSS sends RESOURCE INDICATION messages to the MSC, under the conditions explained above. The RESOURCE INDICATION message shall contain the Resource Indication Method Information Element with the same value as it was requested by the MSC, i.e. the BSS is not allowed to select a method different from the one requested by the MSC.

Furthermore, the RESOURCE INDICATION message may contain the Resource Available IE and the Total Resource Accessible IE dependent on the selected method and, in case of the Total Resource Accessible IE, also dependent on the request from the MSC. If the RESOURCE INDICATION message is just taken as a simple acknowledgement as stated in method i) and iv), the Total Resource Accessible IE shall not be returned independent of whether it was requested by the MSC or not.

For each idle channel the level of interference will be averaged over a period of Intave. (Intave is a parameter set by O&M command on a per cell basis). This averaging will be performed immediately before the transmission of the RESOURCE INDICATION message. The result of this averaging will be used to classify the average interference level on the idle channels into five interference bands.

The Resource Available Information Element contains two pieces of information for each of the five interference bands:

- The number of half rate TCHs available in that band.
- The number of full rate TCHs available in that band.

The levels of the five bands are defined by O&M.

## 3.1.4 Reset

### 3.1.4.1 Global Reset Procedure

The purpose of the reset procedure is to initialise the BSS and MSC in the event of a failure. The procedure is a global procedure applying to a whole BSS, and therefore all messages relating to the reset procedure are sent as global messages using the connectionless mode of the SCCP.

If only a limited part of the MSC or BSS has suffered a failure then clearing procedures can be used to clear only those affected calls.

#### 3.1.4.1.1 Reset at the BSS

In the event of a failure at the BSS which has resulted in the loss of transaction reference information, a RESET message is sent to the MSC or, if the network supports "Intra domain connection of RAN nodes to multiple CN nodes" (see 3GPP TS 23.236 [48]) to all the MSCs towards which the BSS has signalling connections established. This message is used by the MSC to release affected calls and erase all affected references, and to put all circuits into the idle state.

After a guard period of T2 seconds a RESET ACKNOWLEDGE message is returned by the MSC(s) to the BSS indicating that all references have been cleared.

After the sending of the RESET to the MSC(s) a BSS that does not allocate the circuits shall initiate blocking procedures (Block or Circuit group block procedures) for all circuits that are locally blocked on the BSS side, the MSC(s) shall respond as specified in sub-clause 3.1.2. The sending of block messages shall be done without waiting for the acknowledgement to the RESET message.

Upon receipt of a RESET message from the BSS an MSC that does not allocate the circuits shall send block messages (BLOCK or CIRCUIT GROUP BLOCK) for all circuits that are locally blocked on the MSC side, the BSS shall respond to these with blocking acknowledge messages as described in sub-clause 3.1.2.

If a RESET message is received with the information element "A-Interface Selector for RESET" indicating both TDM and IP or if the "A-Interface Selector for RESET" is not present in the RESET message, then the RESET message shall have precedence over all other procedures.

#### 3.1.4.1.2 Reset at the MSC

In the event of a failure at the MSC which has resulted in the loss of transaction reference information, a RESET message is sent to the BSS. This message is used by the BSS to release affected calls and erase all affected references and to put all circuits into the idle state.

After the sending of the RESET to the BSS, an MSC that does not allocate the circuits shall initiate blocking procedures (Block or Circuit group block procedures) for all circuits that are locally blocked on the MSC side, the BSS shall respond as specified in sub-clause 3.1.2. The sending of block messages shall be done without waiting for the acknowledgement to the RESET message.

Upon receipt of a RESET message from the MSC a BSS that does not allocate the circuits shall send block messages (BLOCK or CIRCUIT GROUP BLOCK) for all circuits that were previously locally blocked on the BSS side, the MSC shall respond to these with blocking acknowledge messages as described in sub-clause 3.1.2.

After a guard period of T13 seconds a RESET ACKNOWLEDGE message is returned to the MSC, indicating that all MSs which were involved in a call are no longer transmitting and that all references at the BSS have been cleared.

If a RESET message is received with the information element "A-Interface Selector for RESET" indicating both TDM and IP or if the "A-Interface Selector for RESET" is not present in the RESET message, then the RESET message shall have precedence over all other procedures.

### 3.1.4.1.3 Abnormal Conditions

#### 3.1.4.1.3.1 Abnormal Condition at the BSS

If the BSS sends a RESET message to the MSC and receives no RESET ACKNOWLEDGE message within a period T4 then it shall repeat the entire reset procedure. The sending of the RESET message is repeated a maximum of "n" times where n is an operator matter. After the n-th unsuccessful repetition the procedure is stopped and the maintenance system is informed.

#### 3.1.4.1.3.2 Abnormal Condition at the MSC

If the MSC sends a RESET message to the BSS and receives no RESET ACKNOWLEDGE message within a period T16 then it shall repeat the entire reset procedure. The sending of the RESET message is repeated a maximum of "n" times where n is an operator matter. After the n<sup>th</sup> unsuccessful repetition the procedure is stopped and the maintenance system is informed.

### 3.1.4.2 Reset Circuit

The purpose of the reset circuit procedure is to restore the information in MSC/BSS in the case of a failure which has affected only a small part of the equipment (e.g. abnormal SCCP connection release).

#### 3.1.4.2.1 Reset Circuit at the BSS

If a circuit has to be put to idle at the BSS due to either an abnormal release of the SCCP-connection for a resource that is not configured for A-interface circuit sharing, or an abnormal release of an SCCP connection for a terrestrial resource that is configured for A-interface circuit sharing for which there are no remaining SCCP connections on the resource, a RESET CIRCUIT message will be sent to the MSC. When the MSC receives this message, it clears the possible call and puts the circuit, if known, to the idle state. If the circuit is known, a RESET CIRCUIT ACKNOWLEDGE message is returned to the BSS. If circuit allocation is done by the BSS and if the circuit is locally blocked at the MSC a BLOCK message shall be returned to the BSS. The BSS shall then respond with a BLOCKING ACKNOWLEDGE message, as described in sub-clause 3.1.2. If the circuit is unknown in the MSC, an UNEQUIPPED CIRCUIT message is returned to the BSS.

Timer T19 is used at the BSS to supervise the reset circuit procedure. If the timer elapses before a response (RESET, RESET CIRCUIT ACKNOWLEDGE or UNEQUIPPED CIRCUIT) is returned to the BSS, the procedure is repeated.

#### 3.1.4.2.2 Reset Circuit at the MSC

If a circuit has to be put to idle at the MSC due to either an abnormal release of the SCCP-connection for a resource that is not configured as a shared resource, or an abnormal release of an SCCP connection for a terrestrial resource that is configured for A-interface circuit sharing for which there are no remaining SCCP connections for the resource, a RESET CIRCUIT message will be sent to the BSS. When the BSS receives a RESET CIRCUIT message, it shall respond with a RESET CIRCUIT ACKNOWLEDGE message in case the circuit can be put to idle. If circuit allocation is done by the MSC and if the circuit is locally blocked at the BSS a BLOCK message shall be returned to the MSC. The MSC shall then respond with a BLOCKING ACKNOWLEDGE message, as described in sub-clause 3.1.2. If the circuit is unknown at the BSS, the BSS shall return an UNEQUIPPED CIRCUIT message to the MSC.

Timer T12 is used at the MSC to supervise the reset circuit procedure. If the Timer elapses before a response (RESET, RESET CIRCUIT ACKNOWLEDGE, UNEQUIPPED CIRCUIT or BLOCK) the reset circuit procedure is repeated.

#### 3.1.4.2.3 Abnormal conditions

If a RESET message is received with the information element "A-Interface Selector for RESET" indicating TDM or if the "A-Interface Selector for RESET" is not present in the RESET message, after sending of a RESET CIRCUIT message and before receipt of the corresponding response the respective reset circuit procedure is stopped, i.e. reception of the corresponding RESET CIRCUIT ACKNOWLEDGE message is not required and no repetition is necessary.

If a RESET CIRCUIT message is received immediately after a RESET CIRCUIT message has been sent for the same circuit, the corresponding acknowledgement messages are returned.

The sending of the RESET CIRCUIT message is repeated a maximum of "n" times where n is an operator matter. After the n-th unsuccessful repetition the procedure is stopped and the maintenance system is informed.

### 3.1.4.3 Reset IP Resource

This procedure is relevant when a Call Identifier has been previously sent/received for the concerned connection, i.e. when an IP bearer has been selected for this call.

The purpose of the Reset IP Resource procedure is to initialise part of the resources in the BSS in the event of an abnormal failure in the MSC or vice versa (e.g. Signalling Transport processor reset). The procedure uses connectionless signalling.

#### 3.1.4.3.1 Reset IP Resource procedure initiated by the BSS

The BSS initiates the procedure by sending a RESET IP RESOURCE message to the MSC.

The RESET IP RESOURCE message shall include the Call Identifier List and the Cause with the appropriate cause value (e.g. "abnormal SCCP connection release").

On reception of this message the MSC shall release locally the resources and references associated to the Call Identifiers indicated in the received message. The MSC shall always return the RESET IP RESOURCE ACKNOWLEDGE message to the BSS after all Call Identifier related resources and references have been released and the MSC shall include the list of Call Identifiers. The list of Call Identifiers within the RESET IP RESOURCE ACKNOWLEDGE message shall be in the same order as received in the RESET IP RESOURCE message. Unknown Call Identifiers shall be reported as released.

The MSC shall provide means to prevent the immediate re-assignment of released Call Identifiers to minimise the risk that the Reset IP Resource procedure releases the same Call Identifiers re-assigned to new calls.

Timer Trbss is used at the BSS to supervise the Reset IP Resource procedure. If the timer elapses before a response message (RESET, RESET IP RESOURCE ACKNOWLEDGE) is returned to the BSS, then the RESET IP RESOURCE message may be repeated by the BSS.

#### 3.1.4.3.2 Reset IP Resource procedure initiated by the MSC

The MSC initiates the procedure by sending a RESET IP RESOURCE message to the BSS.

The RESET IP RESOURCE message shall include the Call Identifier List and the Cause with the appropriate cause value (e.g. "abnormal SCCP connection release").

On reception of this message the BSS shall release locally the resources and references associated to the specific Call Identifiers indicated in the received message. The BSS shall always return the RESET IP RESOURCE ACKNOWLEDGE message to the MSC after all Call Identifier related resources and references have been released and the BSS shall include the list of Call Identifiers. The list of Call Identifiers within the RESET IP RESOURCE ACKNOWLEDGE message shall be in the same order as received in the RESET IP RESOURCE message. Unknown Call Identifiers shall be reported as released.

The MSC shall provide means to prevent the immediate re-assignment of released Call Identifiers to minimise the risk that the Reset IP Resource procedure releases the same Call Identifiers re-assigned to new calls.

Timer Trmsc is used at the MSC to supervise the Reset IP Resource procedure. If the Timer elapse before a response message (RESET, RESET IP RESOURCE ACKNOWLEDGE) is returned to the MSC, then the RESET IP RESOURCE message may be repeated by the MSC.

#### 3.1.4.3.3 Abnormal conditions

If a RESET message is received with the information element "A-Interface Selector for RESET" indicating IP or if the "A-Interface Selector for RESET" is not present in the RESET message, after sending of a RESET IP RESOURCE message and before receipt of the corresponding RESET IP RESOURCE ACKNOWLEDGE message, then the respective Reset IP Resource procedure is stopped, i.e. the reception of the corresponding RESET IP RESOURCE ACKNOWLEDGE message is not required and no repetition is necessary.

If a RESET IP RESOURCE message is received immediately after a RESET IP RESOURCE message has been sent for the same Call Identifier, then the corresponding RESET IP RESOURCE ACKNOWLEDGE message is returned after the resources has been released.

The sending of the RESET IP RESOURCE message is repeated a maximum of  $n$  times, where  $n$  is an operator defined value. After the  $n$ -th unsuccessful repetition the procedure is stopped and local resources associated to the specified Call Identifiers shall be considered as released.

If a RESET IP RESOURCE ACKNOWLEDGE message does not contain exactly the same Call Identifiers in the Call Identifier List as sent in the related RESET IP RESOURCE message, the RESET IP RESOURCE message may be repeated.

### 3.1.5 External Handover

The details of the radio information as far as handover is concerned are given in 3GPP TS 24.008. The relevant network information is given in 3GPP TS 23.009.

Using this protocol the BSS should support handover transitions to and from any combinations of the following:

- Channel.
- SDCCH.
- Full Rate TCH.
- Half Rate TCH.
- Multiple Full Rate TCHs.

In this specification three procedures are defined which can be used for handover. They are:

- Handover Required Indication.
- Handover Resource Allocation.
- Handover Execution.

(Figure 16 shows an example of a complete handover procedure.)

For any HANOVER REQUIRED message at most one HANOVER COMMAND message may be sent.

In the case of inter-MS handover the term "the MSC" in this sub-clause is taken to mean the relevant MSC in the handover operation.

The handover procedures are specified in the following sub-clauses.

All messages concerned with handover, with the exception of HANOVER CANDIDATE ENQUIRE and HANOVER CANDIDATE RESPONSE messages, are sent using the connection oriented mode of the SCCP.

#### 3.1.5.1 Handover Required Indication

If an IP based user plane interface is supported, this procedure shall not be used when the target BSS and serving BSS are the same.

The handover required indication procedure allows a BSS to request the handover for a particular MS if it is currently allocated one or more dedicated resources or currently allocated one dedicated resource and one or more packet resources (in which case DTM handover is indicated). This is done by generating a HANOVER REQUIRED message and sending it from the BSS to the MSC. If so required by the BSS, the MSC informs the BSS if the handover cannot be carried out. This is done by a HANOVER REQUIRED REJECT message. The HANOVER REQUIRED message is sent using the BSSAP SCCP connection already set up for that transaction. As part of the BSS's functions, the BSS continually monitors all radio information and compares it with parameters such that if the transmission quality of a given parameter (or set of parameters) passes a predetermined threshold (set by O&M) then a HANOVER REQUIRED message is generated and sent to the MSC.

The BSS shall not initiate the handover required indication procedure in the case of an MOCN configuration if the Rerouting procedure is ongoing.

### 3.1.5.1.1 Generation of the HANDOVER REQUIRED message

Generation of the HANDOVER REQUIRED message can be for the following reasons:

- The BSS has detected that a radio reason exists for a handover to occur.
- The MSC has initiated a handover candidate enquiry procedure, and this MS is currently a candidate.
- A cell change is required at call setup due to congestion, e.g. directed retry.
- A cell change is required at call setup if the indication of Service Handover to another RAT has been received from the MSC (directed retry initiation).

The HANDOVER REQUIRED message contains the following information elements:

- Message Type.
- Cause.
- Cell Identifier List (preferred).

It should also contain the information elements: "Current channel type 1", "Old BSS to New BSS information" and, in case the current channel mode is speech, "Speech version (used)". If an IP based user plane interface is supported, the information element "Speech Codec (used)" is included.

The "Old BSS to New BSS information" is used to pass Field Elements from the old BSS to the new BSS. The information in the "Old BSS to New BSS information" is transparent for the MSC. When the "Old BSS to New BSS information" is present in the HANDOVER REQUIRED message the MSC shall pass it unchanged to any BSS associated to "Cell Identifier List (preferred)" when initiating the Handover resource allocation procedure. The old BSS must ensure that the information contained in the "Old BSS to New BSS information" information element is valid for all cells in the "Cell Identifier List (preferred)".

Sub-clause 3.2.1.9 gives coding details of the above message.

The "Cause" field indicates the reason for the HANDOVER REQUIRED message e.g. "uplink quality poor" or "response to MSC invocation" in the case of traffic reasons indicated by the MSC.

The Cause value sent should be an indication which can be taken into account at the target BSS in future handover decision processes, e.g. to reduce oscillations between BSSs due to the fact that some information (on which the old BSS decided to initiate the handover) is not available at the target BSS (e.g. distance, traffic...).

If present the "Response Request" Information Element indicates, that the BSS requires an indication if the HANDOVER REQUIRED message does not result in a HANDOVER COMMAND message.

If the BSS wants to change the CIC due to a channel change, the BSS sends a HANDOVER REQUIRED message with the cause "switch circuit pool" and the "circuit pool list" information element. The "circuit pool list" information element will allow the BSS to indicate to the MSC from which circuit pool or pools the new CIC should be chosen.

Except in the case of DTM Handover, the "Cell Identifier List (preferred)" shall identify "n" preferred cells. The identified cells are given in order of preference. The algorithm by which the BSS produces this list is Operator dependent and is not addressed in the present document. The "n" number of preferred cells is a parameter set by O&M and shall range from 1 to 16. If "n" number of cells cannot be identified, then only as many as are available shall be encoded and sent (as specified in sub-clause 3.2.2.27). If a LSA information element has been received for a mobile subscriber indicating LSA only access, the "Cell Identifier List" shall contain only cells that are allowed for the subscriber. Exclusive access cells are included into the "Cell Identifier List (preferred)" only if they are allowed for the subscriber or if the connection is an emergency call.

It is mandatory for the BSS to be able to produce this "Cell Identifier List (preferred)". The sending of this list is controlled by the O&M parameter "n". It is mandatory for the MSC to be able to receive and interpret this Information Element.

For the case of DTM Handover (i.e. where both dedicated and packet resources are required in the target cell), the "Cell Identifier List (preferred)" shall identify a single cell, which is the same as the cell identified in the corresponding PS-HANDOVER-REQUIRED PDU (see 3GPP TS 48.018).

The BSS may recommend to the MSC to allow queuing or not in the handover resource allocation procedure by indication in the "Queuing indicator" information element within the HANDOVER REQUIRED message.

The old BSS may inform the new BSS of the presently configured channel in the Current Channel Type 1 information element and in the Current Channel type 2 Field Element. The information contained may be used by the new BSS (e.g. when building the radio interface HANDOVER COMMAND message). Where discrepancies occur between the Current Channel Type 1 and the Current Channel Type 2 then the information in the Current Channel Type 2 shall take precedence if understood by the new BSS.

If, for this mobile station, the old BSS has received a Gb interface SUSPEND ACK PDU, then the old BSS shall include the GPRS Suspend information field in the Old BSS to New BSS IE in the HANDOVER REQUIRED message.

If the old BSS received a GPRS Suspend information field in the Old BSS to New BSS IE in any preceding HANDOVER REQUEST message received by the old BSS, then, the old BSS shall include the GPRS Suspend information field in the Old BSS to New BSS IE in the HANDOVER REQUIRED message.

The old BSS may recommend to the new BSS to allow pre-emption or not allow pre-emption by sending the "prec" bit. The new BSS may take this information into account when performing the Handover resource allocation procedure.

The old BSS may inform the new BSS of radio information pertaining to the target cell in the "Target cell radio information" field element. The old BSS shall only send the "Target cell radio information" field element when it sends a single cell in the "Cell Identifier List (preferred)". This field element may be used by the new BSS (e.g. for radio channel selection).

NOTE 1: It is not recommended that this information element is included if more than one cell is sent in the "Cell Identifier List (preferred)".

The old BSS may inform the new BSS of the presently configured channel in the Current Channel Type 1 information element and in the Current Channel type 2 Field Element. The information contained may be used by the new BSS (e.g. when building the radio interface HANDOVER COMMAND message). Where discrepancies occur between the Current Channel Type 1 and the Current Channel Type 2 then the information in the Current Channel Type 2 shall take precedence if understood by the new BSS.

If the present speech codec is a multi-rate speech codec, the old BSS may inform the new BSS of the current multi-rate codec configuration by including the MultiRate configuration information Field Element in the "Old BSS to New BSS information" information element. If the new BSS assigns a multi-rate speech codec this information may be used by the new BSS, to determine whether or not to include a MultiRate Configuration IE when building the radio interface HANDOVER COMMAND message. If an IP based user plane interface is supported in BSS, the "Speech Codec (used)" shall be included in the HANDOVER REQUIRED message. The MSC determines the speech Codec Type and Codec Configuration and informs the target BSS by the "Codec List (MSC Preferred)".

If the old BSS supports dual transfer mode and the mobile station is in dual transfer mode in the old cell, the old BSS may provide information about the current resources by including the *Dual Transfer Mode information* field element in the "Old BSS to New BSS information" Information Element. The new BSS may use this information to determine the resources for the mobile station in the new cell (e.g. half rate traffic channel, adjacent resources available, EGPRS-capable resource).

For the DTM Handover procedure, the old BSS shall include the *PS Indication* information element within the "Old BSS to New BSS Information" Information Element. The contents of the *PS Indication IE* shall uniquely identify, for this MS, the handover attempt, and shall be identical to the contents of the *CS Indication IE* included in the PS-HANDOVER-REQUIRED PDU (see 3GPP TS 48.018).

The old BSS may provide information about the traffic load of the old cell by including the *Downlink Cell Load Information* and/or the *Uplink Cell Load Information* field elements in the "Old BSS to New BSS information" Information Element. This information shall represent the current traffic load in the cell, that is, prior to the handover procedure. The new BSS may use the information:

- prior to a cell load based handover procedure, to determine whether or not to initiate the handover procedure; and



- in any handover procedure, to update in the new BSS the information about the load on the old cell, which may be used in the initiation of future handover procedures.

NOTE 2: The old BSS should not initiate a cell load based handover procedure if it has knowledge of the load in the target cell and, after a successful completion of the handover procedure, this load would be higher than in the old cell.

In case of handover of a VGCS talking subscriber, the BSS may provide information about the current VGCS talker mode (ie dedicated or group transmit) if the group call is ciphered.

The old BSS may recommend the new BSS not to attempt handovers of this mobile station to UMTS by sending the "UE-prob" bit. The new BSS may take this information into account before starting an Inter-System Handover Required Indication procedure towards UMTS.

Except when sent as part of a DTM Handover procedure, the HANOVER REQUIRED message shall be updated and repeated by the BSS with a periodicity of T7 until:

- A HANOVER COMMAND message is received from the MSC; or
- A RESET message is received; or
- The reason for the original HANOVER REQUIRED message disappears e.g. the MS transmission improves; or
- All communication is lost with the MS as defined in 3GPP TS 24.008, and the transaction is abandoned; or
- The transaction ends, e.g. call clearing.

On sending the HANOVER REQUIRED message as part of a DTM Handover procedure, the old BSS shall start timer T23.

The old BSS shall stop timer T23 when it has received responses from both the MSC and the SGSN:

- from the MSC, a response consisting of either a HANOVER REQUIRED REJECT or a BSSMAP HANOVER COMMAND message; and,
- from the SGSN, a response consisting of either a PS-HANOVER-REQUIRED-ACK PDU or a PS-HANOVER-REQUIRED-NACK PDU.

The old BSS shall stop timer T23 if it receives from the MSC a BSSMAP HANOVER COMMAND message containing a (RR) HANOVER COMMAND message and chooses to proceed with the handover of the dedicated resource only or if it receives from the MSC a BSSMAP HANOVER COMMAND message containing an (RLC/MAC) DTM HANOVER COMMAND message and chooses to begin transmission of the radio interface message to the MS without first waiting for the PS-HANOVER-REQUIRED-ACK PDU (see sub-clause 3.1.5.3.1).

### 3.1.5.1.2 Abnormal conditions for DTM Handover

If timer T23 expires, no message shall be sent to the MS. The subsequent action by the old BSS depends on the messages received prior to the expiry of T23 relating to this handover attempt:

- If the old BSS has received a PS-HANOVER-REQUIRED-ACK PDU, it shall initiate a PS Handover Cancel procedure (see 3GPP TS 48.018).
- If the old BSS has received a BSSMAP HANOVER COMMAND message it shall send a HANOVER FAILURE message to the MSC with cause "DTM Handover - Timer Expired".
- If the old BSS has received neither a BSSMAP HANOVER COMMAND message nor a PS-HANOVER-REQUIRED-ACK PDU, then the handover procedure is terminated and no message is sent to either the MSC or the SGSN.
- Any message or PDU relating to this handover attempt which is received from the MSC or the SGSN after the expiry of timer T23 is discarded.

If the old BSS receives a PS-HANOVER-REQUIRED-NACK PDU and a HANOVER REQUIRED REJECT message then the DTM Handover procedure is terminated and no message shall be sent to either the MSC or the SGSN or the MS.

If the old BSS receives a PS-HANDOVER-REQUIRED-NACK PDU (with cause e.g. "Equipment Failure") and a BSSMAP HANDOVER COMMAND message which contains a *DTM Handover Command Indication* field element within the *New BSS to Old BSS Information* IE then the old BSS shall send a HANDOVER FAILURE message to the MSC with cause "DTM Handover - SGSN failure". No message shall be sent to the MS.

If the old BSS receives a PS-HANDOVER-REQUIRED-NACK PDU (with cause e.g. "DTM Handover - PS Allocation Failure") and a BSSMAP HANDOVER COMMAND message which does not contain a *DTM Handover Command Indication* field element within the *New BSS to Old BSS Information* IE and the old BSS has chosen not to proceed with Handover Execution, then the BSS shall send a HANDOVER FAILURE message to the MSC with cause "DTM Handover - PS Allocation Failure". No message shall be sent to the MS.

If the old BSS receives a PS-HANDOVER-REQUIRED-ACK PDU and a HANDOVER REQUIRED REJECT message then the BSS shall initiate a PS Handover Cancel procedure (see 3GPP TS 48.018). No message shall be sent to the MS.

### 3.1.5.2 Handover Resource allocation

This procedure has been defined to allow the MSC to request resources from a BSS in a manner similar to that used for the assignment case. However it does not result in the transmission of any messages over the radio interface, only in the reservation of the resource(s) identified at the BSS, which awaits access of a MS on the reserved channel(s). These reserved resources are then indicated back to the MSC.

In order to support this procedure the MSC sets up a BSSAP SCCP connection to the BSS. This connection is then used to support all BSSAP messages related to the dedicated resource(s).

In case of Voice Group Call, the MSC may reuse the existing Resource Controlling SCCP connection which has been previously set-up with the new BSS.

#### 3.1.5.2.1 Operation of the procedure

The correct operation of the handover resource allocation procedure is as follows:

The MSC sends a HANDOVER REQUEST message to the new BSS (note) from which it requires radio resources. This message contains details of the resource(s) required. If the MSC allocates the A interface circuits, and if the requested resource(s) is/are for speech or data the message also indicates the terrestrial resource that shall be used between the MSC and the BSS. The MSC should only ever ask for resources from the BSS that it knows are not totally incompatible with the nominated circuit. The type of channel(s) required can be different from the type of channel(s) in use, e.g. in the case of directed retry. The description of the resource(s) can either be a complete specification, or give the BSS some freedom in the selection (for instance channel rate selection, speech version selection etc.). The message may also specify the channel(s) in use, and, in case current channel mode is speech, the speech version used. If an IP based user plane interface is supported, the "Codec List (MSC Preferred)" shall be included in the message.

In case of Voice Group Call, the MSC need not allocate a new A interface circuit. In such a case, the terrestrial resource which has been allocated during the VBS/VGCS assignment procedure is used as the new terrestrial resource. The MSC shall not send a HANDOVER REQUEST message to the BSS to handover a VGCS talker to a cell that has been reported as released through the VGCS/VBS ASSIGNMENT STATUS message for that group call.

On receipt of this message the new BSS shall choose suitable idle radio resources and, if the BSS allocates the A interface circuits and if needed, a terrestrial resource.

In case of Voice Group Call, the new BSS need not allocate new radio resources. In such a case, the radio resource which has been allocated during the VBS/VGCS assignment procedure is used as the new radio resource.

The management of priority levels - relating to the Information Element "Priority" within the HANDOVER REQUEST message - is implementation dependent, under operator control.

If queuing is managed, new requests which cannot be served immediately are put in the queuing file according to the indicated priority levels.

(Refer to sub-clause 3.1.17 for Queuing Procedure.)

As a further operator option, the pre-emption indicators may (alone or along with the priority levels) be used to manage the pre-emption process, which may lead to the forced release or forced handover of lower priority connections.

However, the pre-emption indicators (refer to sub-clause 3.2.2.18), if given in the HANDOVER REQUEST, shall be treated on a per connection basis as follows:

- The last received "Pre-emption Vulnerability" indicator and priority levels shall prevail.
- If the "Pre-emption Capability" bit is set to 1, then this allocation request can trigger the running of the pre-emption procedure.
- If the "Pre-emption Recommendation" bit indicates that pre-emption is recommended by the old BSS, then the new BSS may obey the recommendation and act appropriately based on "Pre-emption Capability Indication" bit.
- If the "Pre-emption Recommendation" bit indicates that pre-emption is not recommended by the old BSS, then the new BSS may obey this recommendation and ignore the "Pre-emption Capability" bit if it is set to 1.
- If the "Pre-emption Recommendation" bit is not present then the pre-emption procedure can be run.
- If the "Pre-emption Capability" bit is set to 0, then this allocation request cannot trigger the pre-emption procedure.
- If the "Pre-emption Vulnerability" bit is set to 1, then this connection is vulnerable and shall be included in the pre-emption process or procedure and as such may be subject to forced release or forced handover.
- If the "Pre-emption Vulnerability" bit is set to 0, then this connection is not vulnerable to pre-emption and shall not be included in the pre-emption process and as such may not be subject to forced release or forced handover.
- If no Priority Information Element has been received, both "Pre-emption Capability" and "Pre-emption Vulnerability" bits shall be regarded as set to 0.

In the case where localised service area is supported, the MSC may inform the BSS as to which LSA identities that the mobile has preferences by sending the LSA INFORMATION message. The BSS stores this information and uses it when determining the target cell list for handover. The algorithm for determining the target cell list for handover is not defined further in the present document.

In the case where Intersystem handover to other RATs is supported, the MSC may inform the target BSS, if preference for other radio access technologies (Service based handover) shall be applied to the MS connection. In such cases the MSC sets the Service Handover Information Element accordingly in the HANDOVER REQUEST message. The Service Handover information is stored in the BSS throughout the connection and is used in Handover evaluation process.

Upon reception of a HANDOVER REQUEST message containing a *PS Indication* IE within the *Old BSS to New BSS Information* information element (i.e. a DTM Handover procedure is ongoing), then the new BSS shall proceed as follows:

- If timer T24 is not running, then the new BSS shall start timer T24.
- When a HANDOVER REQUEST message and PS-HANDOVER-REQUEST PDU have been received and the contents of the *PS Indication* and *CS Indication* IEs are identical, the new BSS shall stop timer T24 and attempt to allocate a dedicated resource and, conditional on the allocation of a the dedicated resource, packet resources (see 3GPP TS 48.018) in accordance with the capabilities of the MS.

If a dedicated radio resource is available then this will be reflected back to the MSC in a HANDOVER REQUEST ACKNOWLEDGE message. If the MSC gave the BSS some freedom in resource type selection, the choices made by the BSS are indicated in the HANDOVER REQUEST ACKNOWLEDGE message. If the BSS allocates the A interface circuits and such a circuit is needed, the circuit allocated by the BSS is indicated in the HANDOVER ACKNOWLEDGE message.

If only dedicated resources are allocated, the HANDOVER REQUEST ACKNOWLEDGE message sent by the new BSS shall contain the radio interface message HANDOVER COMMAND within its "Layer 3 Information" Information Element.

If, in the case of DTM Handover, both dedicated and packet resources are allocated, the HANDOVER REQUEST ACKNOWLEDGE message sent by the new BSS shall contain the radio interface message DTM HANDOVER COMMAND within its "Layer 3 Information" Information Element.

The "Layer 3 Information" (which is in fact either a RR-Layer 3 HANDOVER COMMAND or a RLC/MAC-Layer 2 DTM HANDOVER COMMAND) is transferred by the controlling MSC to the old BSS using the BSSMAP message

HANDOVER COMMAND also within the Information Element "Layer 3 Information" of that BSSMAP message. The new BSS shall indicate that the *Layer 3 Information* IE contains an RLC/MAC DTM HANDOVER COMMAND by including the *DTM Handover Command Indication* field element within the *New BSS to Old BSS Information* IE.

Information about the appropriate new channels and a handover reference number chosen by the new BSS are contained in the HANDOVER COMMAND or DTM HANDOVER COMMAND. Knowledge of the channel in use at the old BSS allows the new BSS to minimize the size of the HANDOVER COMMAND or DTM HANDOVER COMMAND message (i.e. to decide whether the mode of the first channel IE need not be included in the HANDOVER COMMAND). Furthermore, in the case of handover of a VGCS talking subscriber, knowledge of the VGCS talker mode at the old BSS also allows the new BSS to optimise the size of the HANDOVER COMMAND message.

NOTE 1: The new BSS and the old BSS may be the same. If an IP based user plane interface is supported, this procedure can not be used when the target BSS and serving BSS are the same.

In the case of external handover the BSS, when localised service area is supported, will indicate the LSA identity of the target cell in the HANDOVER REQUEST ACKNOWLEDGE message if it corresponds to one of the LSA identities received in the HANDOVER REQUEST message.

When several circuit pools are present on the BSS MSC interface, and a circuit has been allocated by the HANDOVER REQUEST message, the "circuit pool" information field shall be included in the HANDOVER REQUEST ACKNOWLEDGE. The "circuit pool" field will indicate to the MSC the circuit pool of the CIC given in the HANDOVER REQUEST message.

In the case of a handover from *A/Gb mode* to *A/Gb mode*, the *New BSS to Old BSS Information* information element is used to pass Field Elements from the new BSS to the old BSS. The information in the *New BSS to Old BSS information* information element is transparent for the MSC. When the *New BSS to Old BSS information* information element is present in the HANDOVER REQUEST ACKNOWLEDGE message, the MSC may pass it to the old BSS when initiating the Handover Execution procedure.

In the case of a handover from *Iu mode* (GERAN or UTRAN) to *A/Gb mode*, the *Inter-System Information* information element is used to pass Field Elements from the new BSS to the old system. The information in the *Inter-System Information* information element is transparent for the MSC. When the *Inter-System Information* information element is present in the HANDOVER REQUEST ACKNOWLEDGE message, the MSC may pass it to the old system.

The new BSS may provide information about the traffic load of the target cell by including the *Downlink Cell Load Information* and/or the *Uplink Cell Load Information* field elements in the *New BSS to Old BSS information* or in the *Inter-System Information* information elements. This information shall represent the traffic load in the cell assuming a successful completion of the handover procedure in progress. The old BSS may use the information to update the information about the load on the new cell, which may be used in the initiation of future cell load based handover procedures.

If local switching is requested by the core network, the MSC includes the Global Call Reference IE, LCLS-Configuration IE and the LCLS-Connection-Status-Control IE in the HANDOVER REQUEST message.

If the BSS supports Local Call Local Switch (LCLS) and receives the HANDOVER REQUEST message containing the Global Call Reference IE, the LCLS-Configuration IE and the LCLS-Connection-Status-Control IE, then the BSS shall store the Global Call Reference (GCR) value and check if the requested LCLS configuration included in the LCLS-Configuration IE is supported.

- If the requested LCLS configuration is not supported, then the BSS shall indicate this to the MSC in the LCLS-BSS-Status IE included in the HANDOVER REQUEST ACKNOWLEDGE message, see sub-clause 3.1.33.2.3.
- If the BSS supports the requested LCLS configuration, then the BSS shall perform call leg correlation as described in sub-clause 3.1.33.2.1 and report the outcome to the MSC in LCLS-BSS-Status IE included in the HANDOVER REQUEST ACKNOWLEDGE message.
- If the call becomes local, then the BSS shall notify the MSC serving the other call leg, see sub-clause 3.1.33.5.

NOTE 2: The BSS shall during the handover procedure indicate the final LCLS connection status value within the HANDOVER COMPLETE message, see sub-clause 3.1.5.3.1.

NOTE 3: If the BSS does not support LCLS then the Global Call Reference IE, the LCLS-Configuration IE and the LCLS-Connection-Status-Control IE in the HANDOVER REQUEST message will be ignored by the BSS and no LCLS-BSS-Status IE will be returned in the HANDOVER REQUEST ACKNOWLEDGE message and in the HANDOVER COMPLETE message.

The sending of the HANOVER REQUEST ACKNOWLEDGE by the new BSS to the MSC ends the Handover Resource Allocation procedure. The Handover Execution procedure can now proceed and this is given in sub-clause 3.1.5.3.

The new BSS shall then take all necessary action to allow the MS to access the radio resource(s) that the new BSS has chosen, this is detailed in the 3GPP TS 45 series of Technical Specifications. If the radio resource(s) is a traffic channel or a group of traffic channels, then the new BSS shall at this point switch it through to the terrestrial resource indicated in the HANOVER REQUEST message, and the necessary transcoding/rate adaptation/encryption equipment enabled as detailed in 3GPP TS 24.008.

The optimum procedure for switching through to the target cell at the MSC is not defined in these Technical Specifications.

If either:

- a CLEAR COMMAND is received from the MSC; or
- a reset is received from the MSC,

then the Handover Resource Allocation procedure shall be cancelled and the possibly already allocated radio resources shall be released and the terrestrial resources marked as idle.

### 3.1.5.2.2 Handover Resource Allocation Failure

The following failure conditions of this procedure may occur:

The BSS may not be able to use the terrestrial resource (that is, a terrestrial circuit or an IP based user plane interface) that the MSC has indicated in which case a HANOVER FAILURE message will be returned with the Cause value set to: "requested terrestrial resource unavailable".

The BSS may not be able to support the requested ciphering algorithm and in this case a HANOVER FAILURE message shall be returned to the MSC with the Cause value "Ciphering algorithm not supported".

If the requested channel type or resource (e.g. channel rate, speech version, Codec Type, Codec Configuration, Interface Type, etc.) indicated in the HANOVER REQUEST message is temporarily not available (e.g. due to overload) or not supported in the BSS, then a HANOVER FAILURE message shall be returned to the MSC. The appropriate failure cause will be included in the message (Cause value: "requested transcoding/rate adaptation unavailable" or "requested speech version unavailable" or "Requested Codec Type or Codec Configuration unavailable" or "Requested Codec Type or Codec Configuration not supported" or "Requested A-Interface Type unavailable" or "Requested A-Interface Type not supported").

If the MSC requested an IP-bearer for the A-Interface by providing the AoIP Transport Layer Address and not providing a Circuit Identity Code, but the BSS is not able to use an IP-bearer, then the BSS shall not allocate a Circuit Identity Code on its own, even if the Codec List (MSC Preferred) included a Codec Type with the PT bit set to "1", but shall return a HANOVER FAILURE message to the MSC with the Cause value "Requested A-Interface Type unavailable".

If, on reception of the HANOVER REQUEST by the BSS, the circuit pool implied by the CIC information element is incompatible with the channel type indicated (that is, the pool does not support any of the radio resources indicated by the channel type) a HANOVER FAILURE shall be returned to the MSC with the failure cause set to "circuit pool mismatch".

If, on reception of the HANOVER REQUEST by the BSS, the circuit pool implied by the CIC is compatible with the channel type indicated (that is, the pool supports at least one of the radio resource types indicated by the channel type), but the BSS still wishes to change the circuit pool, it sends a HANOVER FAILURE with the cause "switch circuit pool" and the "circuit pool list" information element.

The "circuit pool" information element, when present in the HANOVER FAILURE, indicates to the MSC which circuit pool the CIC indicated in the HANOVER REQUEST belongs to. This can be used by the MSC to correct its tables (CIC/circuit pool). The "circuit pool list" information element, when present in the HANOVER FAILURE, is used when the BSS wishes to indicate to the MSC its preferred circuit pools. The circuit pools in the "circuit pool list" information element shall be given in order of preference. In the case of a HANOVER FAILURE with the cause "circuit pool mismatch", the MSC may decide to block the circuit and to send an O & M notification.

Other possible cause values which may be returned with the HANDOVER FAILURE message are: "equipment failure", "no radio resource available", "O&M intervention".

The MSC may not be able to use the terrestrial resource that the BSS has indicated. In this case, the procedure is nevertheless considered terminated successfully, and it is up to the MSC to correct the situation, e.g. by a circuit re-selection procedure.

If a DTM Handover is ongoing and the allocation of the packet resources fails (i.e. the PS Handover Request procedure (see 3GPP TS 48.018) fails at the new BSS), then the new BSS shall send a PS-HANDOVER-REQUEST-NACK PDU with cause "DTM Handover - PS Allocation failure" to the SGSN (see 3GPP TS 48.018) and either terminate the Handover Resource Allocation procedure and send a HANDOVER FAILURE message with cause "DTM Handover - PS Allocation failure" to the MSC, or proceed with the Handover Resource Allocation procedure allocating only a dedicated resource (see sub-clause 3.1.5.2.3).

If a DTM Handover is ongoing, then a failure in the allocation of the dedicated resource for any of the reasons described above shall implicitly cause the allocation of PS resources as part of the corresponding PS Handover Request procedure to fail in the new BSS (see 3GPP TS 48.018). In this case the new BSS shall terminate the Handover Resource Allocation procedure by sending a HANDOVER FAILURE message (with appropriate cause e.g. "No radio resource available") to the MSC and a PS-HANDOVER-REQUEST-NACK PDU with cause "DTM Handover - No CS Resource" to the SGSN (see 3GPP TS 48.018).

The *New BSS to Old BSS information* information element is used to pass Field Elements from the new BSS to the old BSS. The information in the *New BSS to Old BSS information* information element is transparent for the MSC. When the *New BSS to Old BSS information* information element is present in the HANDOVER FAILURE message, the MSC may pass it to the old BSS in the HANDOVER REQUIRED REJECT message.

The new BSS may provide information about the traffic load of the target cell by including the *Downlink Cell Load Information* and/or the *Uplink Cell Load Information* field elements in the *New BSS to Old BSS information* information element. This information shall represent the current traffic load in the cell. The old BSS may use the information to update the information about the load on the new cell, which may be used in the initiation of future cell load based handover procedures.

NOTE: The new BSS may reject the attempt of a cell load based handover procedure if the load in the target cell after a successful completion of the handover procedure would be higher than in the old cell.

The generation of the HANDOVER FAILURE message terminates the procedure and allows all references in the new BSS to be released.

Further actions in the MSC concerning handover depend upon the handover algorithm which is operator dependent. If an unrecognised Handover Failure cause value is received, the Class of the cause value should be used to determine the MSC's action.

### 3.1.5.2.3 Abnormal conditions

If after receipt of a HANDOVER REQUEST message, the new BSS receives another HANDOVER REQUEST message on the same SCCP connection, then the later message will be discarded.

If the BSS receives a HANDOVER REQUEST message allocating a terrestrial circuit which the BSS has marked as blocked by a previous blocking procedure, then a HANDOVER FAILURE message shall be returned to the MSC with the Cause set to "requested terrestrial resource unavailable". A single global BLOCK message (not repeated and not guarded by timer T1) shall be sent for that concerned terrestrial circuit.

If the BSS receives a HANDOVER REQUEST message indicating a target cell which is not controlled by the BSS, then a HANDOVER FAILURE message shall be returned to the MSC with the cause set to "invalid cell".

If timer T24 expires and the new BSS has received a HANDOVER REQUEST message (i.e. no corresponding PS HANDOVER REQUEST PDU has been received), the new BSS may either abort the Handover Resource Allocation procedure by sending a HANDOVER FAILURE message to the MSC with cause "DTM Handover - Timer Expiry", or continue with the Handover Resource Allocation procedure, allocating only a dedicated resource. In the latter case, the new BSS sends a HANDOVER REQUEST ACKNOWLEDGE message to the MSC with the *Layer 3 Information* IE containing an RR HANDOVER COMMAND message, does not include the *DTM Handover Command Indication* field element within the *New BSS to Old BSS Information* IE and no longer considers the DTM Handover procedure to be ongoing. In either case, the new BSS shall store the contents of the *PS Indication* IE and the identity of the MS.

If timer T24 expires and the new BSS has received a PS HANDOVER REQUEST PDU (i.e. no corresponding HANDOVER REQUEST message has been received), the ongoing PS Handover Request procedure implicitly fails and the new BSS shall send a PS-HANDOVER-REQUEST-NACK PDU to the SGSN with cause "DTM Handover - Timer expiry" (see 3GPP TS 48.018). If the new BSS receives a HANDOVER REQUEST containing a *PS Indication* IE which corresponds to a handover procedure which has previously been terminated due to the expiry of timer T24, then it shall send a HANDOVER FAILURE message to the MSC with cause "DTM Handover - Invalid PS Indication". Any ongoing Handover Resource Allocation procedure corresponding to the same mobile station (i.e. one identified by a different PS Indication Contents in the *PS Indication* IE) should continue.

### 3.1.5.3 Handover execution

If a DTM Handover procedure is not ongoing, handover execution in the context of the BSS/MSC interface is the process whereby an MSC instructs an MS to tune to a new dedicated radio resource or to a group of radio resources, which may be on a different cell.

If a DTM Handover procedure is ongoing, then Handover Execution is the process whereby the radio interface DTM HANDOVER COMMAND message is transmitted to the MS by the old BSS.

#### 3.1.5.3.1 Operation of the procedure

The correct operation of the procedure is as follows:

The BSSMAP HANDOVER COMMAND message is generated by the MSC and transmitted over the BSSAP connection to the old BSS which is currently supporting the concerned MS.

Except in the case of DTM Handover, the radio interface HANDOVER COMMAND message is sent by the old BSS, to the concerned MS once the old BSS has received the BSSMAP HANDOVER COMMAND message.

If, in the case of DTM Handover, the old BSS receives from the MSC a BSSMAP HANDOVER COMMAND message and the *DTM Handover Command Indication* field element is included within the *New BSS to Old BSS Information* IE, the old BSS should wait until it receives a PS-HANDOVER-REQUIRED-ACK PDU (if it has not already), then stop timer T23 and transmit the (RLC/MAC) DTM HANDOVER COMMAND radio interface message to the MS (see 3GPP TS 44.060). Alternatively, the old BSS may transmit the (RLC/MAC) DTM HANDOVER COMMAND and stop timer T23 without waiting for a PS-HANDOVER-REQUIRED-ACK PDU. If, in this case, the old BSS subsequently receives a PS-HANDOVER-REQUIRED-NACK PDU before it has completed transmission of the (RLC/MAC) DTM HANDOVER COMMAND message it should abort the transmission of the message and proceed as described in sub-clause 3.1.5.1.2.

If, in the case of DTM Handover, the old BSS receives from the MSC a BSSMAP HANDOVER COMMAND message and the *DTM Handover Command Indication* field element is not included within the *New BSS to Old BSS Information* IE and the old BSS chooses to proceed with the Handover Execution procedure, it shall stop T23 and send the RR HANDOVER COMMAND message to the MS.

NOTE: If the old BSS chooses not to proceed with the Handover Execution in this case, then it shall proceed as specified in sub-clause 3.1.5.1.2.

In the case of DTM Handover, the old BSS shall start timer T8 when it sends the DTM HANDOVER COMMAND (or RR HANDOVER COMMAND message, if it proceeds with the Handover Execution procedure when only a dedicated resource was allocated) to the mobile. Otherwise, the old BSS shall start timer T8 on receipt of the BSSMAP HANDOVER COMMAND message.

The air interface message (either DTM HANDOVER COMMAND or RR HANDOVER COMMAND) contains a handover reference number, previously allocated by the new BSS.

The BSSMAP HANDOVER COMMAND message generated by the MSC may contain a *Cell Identifier* IE which indicates to the old BSS the target cell identity to which the handover is to be performed. In case of failure, this information allows the old BSS to know on which cell the handover failed.

The BSSMAP HANDOVER COMMAND message may contain information about the traffic load of the new cell by including the *Downlink Cell Load Information* and/or the *Uplink Cell Load Information* field elements in the *New BSS to Old BSS information* information element. The old BSS may use the information to update the information about the load on the new cell, which may be used in the initiation of future cell load based handover procedures.

When the MS accesses the radio resource(s) of the new BSS with a HANDOVER ACCESS burst which contains the received handover reference number then:

- The new BSS checks the handover reference number to ensure that it is the same as expected, and hence that there is a high probability that the correct MS has been captured (if the handover reference is not as expected then the new BSS shall wait for an access by the correct MS).
- If the handover reference number is as expected, the new BSS shall send a HANDOVER DETECT message to the MSC.
- When the MS is successfully in communication with the network, i.e. the RR message HANDOVER COMPLETE has been received from the MS, then the new BSS will immediately send a BSSMAP message HANDOVER COMPLETE to the MSC and, in the case of DTM Handover, a PS-HANDOVER-COMplete PDU to the SGSN (see 3GPP TS 48.018), and terminate the procedure.

If LCLS is supported in the BSS and the BSS determines that the call is an intra-BSS call which can be locally switched it shall not through-connect the two parties unless explicitly indicated to do so in the HANDOVER REQUEST message by receiving the LCLS-Connection-Status-Control IE set to "Connect" and the other call leg has previously received LCLS-Connection-Status-Control IE set to "Connect".

If local switching is requested by the core network and LCLS is supported in the BSS, the BSS shall inform the MSC of the local switch establishment outcome by including the LCLS-BSS-Status IE with the correct LCLS connection status value according to sub-clause 3.2.2.119 within the BSSMAP HANDOVER COMPLETE message. The BSS shall also notify the MSC serving the other call leg if the LCLS connection status is changed for this call leg, see sub-clause 3.1.33.5.

In the case where the new BSS hands the MS to a Group call channel, the BSS shall send a CLEAR REQUEST with cause "Joined group call channel" directly after having sent the HANDOVER COMPLETE message.

In the case of point to point calls the MSC shall terminate the procedure with the old BSS by sending a CLEAR COMMAND with cause "Handover successful".

In the case of a handover from a Group call channel the MSC shall terminate the procedure by sending a HANDOVER SUCCEEDED message. On receipt of a HANDOVER SUCCEEDED from the MSC, the old BSS shall stop timer T8.

The old dedicated radio resource(s) and connected terrestrial resource shall remain assigned until either the MSC instructs the old BSS to release the resource(s) by a CLEAR COMMAND or a reset occurs.

After the completion of the handover procedure, until the connection is released or the MSC performs an assignment, any dedicated resource assigned to the mobile station, e.g. at internal handover, must be in accordance with the description in the HANDOVER REQUEST message.

If either:

- a CLEAR COMMAND is received from the MSC; or
- a reset is received from the MSC,

before an MS with the correct handover reference accesses the new BSS then the radio resources shall be released and the terrestrial resources marked as idle

The relevant radio interface layer 3 procedures are described in 3GPP TS 24.008.

The MSC always terminates this procedure by use of a clear sequence as follows:

- The MSC sends a CLEAR COMMAND to the old BSS. On receipt of a CLEAR COMMAND from the MSC the old BSS shall stop timer T8 and release all involved resources that were allocated to the MS that had been handed over and returns a CLEAR COMPLETE message to the MSC.
- On receipt of the CLEAR COMPLETE, the MSC shall initiate the release of the SCCP connection to the old BSS and thereby terminate association with the old BSS for this process.



### 3.1.5.3.2 Handover Failure

If a HANOVER FAILURE message radio interface message is received from the MS on the old (main) channel by the old BSS, the old BSS shall then send to the MSC the BSSMAP HANOVER FAILURE message and, in the case of DTM Handover, the old BSS shall also start the PS Handover Cancel procedure (see 3GPP TS 48.018). If the radio interface HANOVER FAILURE message is the result of the MS returning to the old BSS after failing to establish on the new BSS, then the cause value "radio interface failure, reversion to old channel" shall be included in the BSSMAP HANOVER FAILURE message. Furthermore, it is recommended that the air interface RR cause be included as well in this message.

If the MSC receives the BSSMAP HANOVER FAILURE message from the old BSS (with any cause value) and if the target channel is not a Group Call Channel, the handover procedure at the target new BSS is then terminated by the MSC using a clear sequence as follows:

- The MSC sends a CLEAR COMMAND message with the cause "Radio interface failure, reversion to old channel" to the new BSS. On receipt of a CLEAR COMMAND message from the MSC, the new BSS shall release all involved resources that were allocated during the handover resource allocation procedure and return a CLEAR COMPLETE message to the MSC.
- On receipt of the CLEAR COMPLETE message, the MSC shall initiate the release of the SCCP connection to the new BSS and thereby terminate the association with the new BSS for this process.

The call between the MS and the old BSS and between the old BSS and the MSC shall continue as if there had been no handover attempt.

Further actions in the MSC concerning handover depends on the handover algorithm which is operator dependent.

In the case of a talker on a group call channel the MS may release the uplink whilst the handover is being performed, in this case the old BSS shall cancel the handover internally, the MSC should cancel the handover and initiate the release of the A interface resources allocated in the new BSS.

### 3.1.5.3.3 Abnormal Conditions

Whilst the handover execution procedure is in operation, any other messages received at the old BSS relating to this connection and concerning assignment, handover, or cipher mode control should be discarded.

Whilst the handover execution procedure is in operation the old BSS should not attempt to invoke any other procedure related to this call e.g. handover required indication.

If at the old BSS a CLEAR COMMAND message from the MSC or a HANOVER FAILURE message from the MS is not received before the expiry of timer T8 then the old BSS shall release the dedicated radio resources. A BSSMAP message CLEAR REQUEST is also sent to the MSC with a cause "Radio Interface Message Failure". The terrestrial resource in the old BSS shall remain assigned until a CLEAR COMMAND message is received from the MSC, at which point the old BSS shall mark the terrestrial resources as IDLE and return a CLEAR COMPLETE message to the MSC. The MSC shall subsequently release the SCCP connection to the old BSS and thereby terminate association with the old BSS for this process.

In case DTM Handover is ongoing, if T8 expires, the old BSS shall also release the allocated PS resources and initiate a PS Handover Cancel procedure. The cause value in the PS-HANOVER-CANCEL PDU shall be set to "Radio contact lost with MS" (see 3GPP TS 48.018).

In the case of a handover from a Group call channel, if at the old BSS a CLEAR COMMAND or HANOVER SUCCEEDED message from the MSC or a HANOVER FAILURE message from the MS is not received before the expiry of timer T8 then the old BSS shall release the uplink and send a UPLINK RELEASE INDICATION to the MSC.

The MSC shall also initiate release of the resources allocated by the new BSS during the handover resource allocation procedure by sending a CLEAR COMMAND message to the new BSS. The new BSS shall release all the resources that were assigned for that aborted handover and return a CLEAR COMPLETE message to the MSC. The MSC shall subsequently release the SCCP connection to the new BSS and thereby terminate association with the new BSS for this process.

### 3.1.5a Handover from GSM to another System

Using this protocol the BSS should support handover transitions to other systems from an SDCCH, a Full Rate TCH a Half Rate TCH and Multiple Full Rate TCHs.

There are three procedures which are used for inter-system handover. They are:

- Inter-System Handover Required Indication.
- Inter-System Handover Resource Allocation.
- Inter-System Handover Execution.

The first and part of the third of these procedures are specified in this specification. The second and other part of the third procedures are specified in the relevant specification of the target system.

For any HANOVER REQUIRED message at most one HANOVER COMMAND message may be sent.

If so required by the BSS, the MSC shall inform the BSS if the handover cannot be carried out. This is done by a HANOVER REQUIRED REJECT message.

In the case of inter-MSC handover the term "the MSC" in this sub-clause is taken to mean the relevant MSC in the handover operation.

The inter-system handover procedures are specified in the following sub-clauses. All messages concerned with inter-system handover are sent using the connection oriented mode of the SCCP.

#### 3.1.5a.1 Generation of the HANOVER REQUIRED message for intersystem handover

The HANOVER REQUIRED message contains the following information elements:

- Message Type.
- Cause.
- Cell Identifier List.

In case of Inter System Handover it contains the information element: "Source RNC to target RNC transparent information".

The "Source RNC to target RNC transparent information" is used to pass information from the old BSS to the target RNC. The information in the "Source RNC to target RNC transparent information" is transparent for the MSC. At presence of the "Source RNC to target RNC transparent information" in the HANOVER REQUIRED message the MSC shall pass it unchanged to the Target RNC when initiating the Handover resource allocation procedure. The Target RNC is identified by the Target ID information contained in the Cell Identifier List IE. The Target ID information is structured routing information as required by the core network (see 3GPP TS 25.413). The information contained in the "Source RNC to target RNC transparent information" information element is coded as required by the target system.

Sub-clause 3.2.1.9 gives coding details of the above message.

The "Cause" field indicates the reason for the HANOVER REQUIRED message e.g. "downlink quality".

The Cell Identification Discriminator field within the Cell Identifier List IE in the HANOVER REQUIRED message can be used to deduce that this is an intersystem handover.

If present the "Response Request" Information Element indicates, that the BSS requires an indication if the HANOVER REQUIRED message does not result in a HANOVER COMMAND message.

The Cell Identifier List IE contains the RNC-ID (or the Extended RNC-ID) (and additionally the LAC or LAC and PLMN-ID depending on the configuration of the network) of the target for intersystem handover. In case of DTM Handover to UTRAN, the RNC-ID (or the Extended RNC-ID) shall be as same as the RNC Identifier specified in the corresponding PS HANOVER REQUIRED PDU (see 3GPP TS 48.018).

It is mandatory for BSS to produce the RNC-ID (or the Extended RNC-ID). It is mandatory for the MSC to be able to receive and interpret this Information Element for routing purpose.

The BSS may recommend to the target RNC to allow pre-emption or not allow pre-emption by sending the "prec" bit. The target RNC may take this information into account when performing the Handover resource allocation procedure.

In case of handover to a UTRAN CSG cell or a hybrid cell, the source BSS shall include the *CSG Identifier* information element in the HANOVER REQUIRED message. The source BSS shall set the value of the *Cell Access Mode* field in the *CSG Identifier* information element according to the information received from the MS through measurement reporting as defined in 3GPP TS 44.018.

In case of handover to GERAN *Iu mode* the BSS may include the "GERAN Classmark" Information Element, indicating the supported CS services of the target cell in the HANOVER REQUIRED message (see 3GPP TS 43.051). In case the serving and the target cells provide the same capabilities with regard to CS services the exchange of the "GERAN Classmark" between RAN and CN is not required during the handover procedure. In case the serving and the target cells do not provide the same capabilities with regard to CS services, the exchange of the "GERAN Classmark" between RAN and CN is required during the handover procedure to avoid that the CN has to store cell related information and to be able to reuse the existing handover procedure inside the CN.

In case of DTM Handover to UTRAN, the old BSS shall set the *Number of Iu Instances* IE equal to 2 in the *Source RNC to Target RNC Transparent Container* IE (see 3GPP TS 25.413)

The old BSS may provide information about the traffic load of the old cell by including the *Cell Load Information Group* field elements in the *Source RNC to Target RNC Transparent Information* information element. This information shall represent the current traffic load in the cell, that is, prior to the handover procedure. This information shall also include the source cell identifier to which the included traffic load values corresponds. The target RNC may use the information to update the information about the load on the old cell, which may be used in the initiation of future cell load based handover procedures.

NOTE: The old BSS should not initiate a cell load based handover procedure if it has knowledge of the load in the target cell and, after a successful completion of the handover procedure, this load would be higher than in the old cell.

Except when sent as part of an intersystem DTM Handover procedure, the HANOVER REQUIRED message shall be updated and repeated by the BSS with a periodicity of T7 until:

- A HANOVER COMMAND message is received from the MSC; or
- A RESET message is received; or
- The reason for the original HANOVER REQUIRED message disappears e.g. the MS transmission improves; or
- All communication is lost with the MS as defined in 3GPP TS 44.018, and the transaction is abandoned; or
- The transaction ends, e.g. call clearing.

On sending the HANOVER REQUIRED message as part of a DTM Handover to UTRAN procedure, the old BSS shall start timer T23. The old BSS shall stop timer T23 as described in sub-clauses 3.1.5.1.1. In case of T23 expiry or the failure of resource allocation, the old BSS shall behave as described in sub-clause 3.1.5.1.2.

In case of handover to a UTRAN CSG cell, if the MSC receives in the HANOVER REQUIRED message the *CSG Identifier* IE with the *Cell Access Mode* field set to 'CSG cell', it shall perform access control. If the result indicates that the MS is allowed to access the target cell the MSC shall continue the handover to the target side.

In case of handover to a UTRAN Hybrid cell, if the MSC receives in the HANOVER REQUIRED message the *CSG Identifier* IE with the *Cell Access Mode* field set to 'Hybrid cell', it shall provide the CSG membership status of the MS and the *CSG Id* to the target side.

### 3.1.5a.2 Inter-System Handover Resource Allocation Failure

If the MSC receives a HANOVER REQUIRED message indicating an unknown target RNC then, if so required by the BSS, the MSC shall send a HANOVER REQUIRED REJECT message to the old BSS with a cause value indicating 'invalid cell'.

If the MSC receives a HANOVER REQUIRED message with the *CSG Identifier* information element with the *Cell Access Mode* field set to 'CSG cell', and the access control indicates that the MS is not allowed to access the target cell, the MSC shall send a HANOVER REQUIRED REJECT message to the old BSS with a cause value indicating 'Invalid CSG cell'.

If the MSC or the target system is unable to allocate resources for the handover attempt then, if so required by the BSS, the MSC shall send a HANOVER REQUIRED REJECT message to the old BSS with an appropriate cause value.

If the target system establishes that the mobile station being handed over does not support the inter-system procedure correctly and if so required by the BSC, then the MSC shall send a HANOVER REQUIRED REJECT message to the old BSS with a cause value indicating 'Incoming Relocation Not Supported Due To PUESBINE Feature'. The old BSS should not attempt further inter-system handovers for this mobile station.

The *New BSS to Old BSS information* information element is used to pass Field Elements from the new system to the old BSS. The information in the *New BSS to Old BSS information* information element is transparent for the MSC. When the *New BSS to Old BSS information* information element is present in the message received from target RNC, the MSC may pass it to the old BSS in the HANOVER REQUIRED REJECT message.

The new BSS may provide information about the traffic load of the target cell by including the *Downlink Cell Load Information* and/or the *Uplink Cell Load Information* field elements in the *New BSS to Old BSS information* information element. This information shall represent the current traffic load in the cell. The old BSS may use the information to update the information about the load on the new cell, which may be used in the initiation of future cell load based handover procedures.

### 3.1.5a.3 Intersystem handover Execution

The correct operation of the procedure is as follows:

The BSSMAP HANOVER COMMAND message is generated by the MSC and transmitted over the BSSAP connection to the old BSS which is currently supporting the concerned MS.

If DTM Handover is not ongoing, then the old BSS shall start timer T8 on the receipt of the BSSMAP HANOVER COMMAND message which contains the Layer 3 Information IE including radio interface handover command message. An intersystem handover command radio interface message (e.g. INTER SYSTEM TO UTRAN HANOVER COMMAND) is then sent by the old BSS, to the concerned MS.

In case of DTM Handover to UTRAN, the old BSS shall start timer T8 when it sends the (RLC/MAC) DTM HANOVER COMMAND message containing a (RRC) HANOVER TO UTRAN COMMAND message to the concerned MS.

The BSSMAP HANOVER COMMAND message may contain information about the traffic load of the new cell by including the *Downlink Cell Load Information* and/or the *Uplink Cell Load Information* field elements in the *New BSS to Old BSS information* information element. The old BSS may use the information to update the information about the load on the new cell, which may be used in the initiation of future cell load based handover procedures.

When the MS accesses the radio resource(s) of the new RNC then:

- the new RNC shall cause a Handover Detect indication to be sent to the MSC;
- when the MS is successfully in communication with the network, then the new RNC shall cause a Handover Complete indication to be sent to the MSC and terminate the procedure.

The relevant radio interface layer 3 procedures are described in 3GPP TS 25.331 and 3GPP TS 44.018.

The MSC always terminates this procedure by use of a clear sequence as follows:

- The MSC sends a CLEAR COMMAND to the old BSS. On receipt of a CLEAR COMMAND from the MSC the old BSS shall stop timer T8 and release all involved resources that were allocated to the MS that had been handed over and returns a CLEAR COMPLETE message to the MSC.
- On receipt of the CLEAR COMPLETE, the MSC shall initiate the release of the SCCP connection to the old BSS and thereby terminate association with the old BSS for this process.

### 3.1.5a.4 Inter System Handover Failure

If a HANOVER FAILURE radio interface message is received from the MS on the old (main) channel by the old BSS, the old BSS shall then send to the MSC the BSSMAP HANOVER FAILURE message and in the case of DTM Handover to UTRAN, the old BSS shall also start the PS Handover Cancel procedure (see 3GPP TS 48.018).

If the radio interface HANOVER FAILURE message is the result of the MS returning to the old BSS after failing to establish on the new BSS, then the cause value "radio interface failure, reversion to old channel" shall be included in the BSSMAP message HANOVER FAILURE. Furthermore, it is recommended that the air interface RR cause be included as well in this message.

If the MSC receives the BSSMAP HANOVER FAILURE message from the old BSS (with any cause value, the handover procedure at the target is then terminated by the MSC.

The call between the MS and the old BSS and between the old BSS and the MSC shall continue as if there had been no handover attempt.

### 3.1.5a.5 Abnormal Conditions

Whilst the handover execution procedure is in operation, any other messages received at the old BSS relating to this connection and concerning assignment, handover, or cipher mode control should be discarded.

Whilst the handover execution procedure is in operation the old BSS should not attempt to invoke any other procedure related to this call e.g. handover required indication.

If at the old BSS a CLEAR COMMAND message from the MSC or a HANOVER FAILURE message from the MS is not received before the expiry of timer T8 then the old BSS shall release the dedicated radio resources. A BSSMAP message CLEAR REQUEST is also sent to the MSC with a cause "Radio Interface Message Failure". The terrestrial resource in the old BSS shall remain assigned until a CLEAR COMMAND is received from the MSC, at which point the old BSS shall mark the terrestrial resources as IDLE and return a CLEAR COMPLETE message to the MSC. The MSC shall subsequently release the SCCP connection to the old BSS and thereby terminate association with the old BSS for this process.

In case of DTM Handover to UTRAN is ongoing, if T8 expires, the old BSS shall also release the allocated PS resources and initiate a PS Handover Cancel procedure. The cause value in the PS-HANOVER-CANCEL PDU shall be set to "Radio contact lost with MS" (see 3GPP TS 48.018).

In the case of a handover from a Group call channel, if at the old BSS a CLEAR COMMAND or HANOVER SUCCEEDED message from the MSC or a HANOVER FAILURE message from the MS is not received before the expiry of timer T8 then the old BSS shall release the uplink and send a UPLINK RELEASE INDICATION to the MSC.

The MSC shall also initiate release of the resources allocated by the new BSS during the handover resource allocation procedure by sending a CLEAR COMMAND to the new BSS. The new BSS shall release all the resources that were assigned for that aborted handover and return a CLEAR COMPLETE to the MSC. The MSC shall subsequently release the SCCP connection to the new BSS and thereby terminate association with the new BSS for this process.

## 3.1.5b Handover from another system to GSM

### 3.1.5b.1 General

Using this protocol the BSS should support handover transitions from other systems to an SDCCH, a Full Rate TCH a Half Rate TCH and Multiple Full Rate TCHs.

There are three procedures which are used for handover from another system to GSM. They are:

- Inter-System Handover Required Indication.
- Inter-System Handover Resource Allocation.
- Inter-System Handover Execution.

The second part of these procedures is specified in this specification. The first and third parts procedures are specified in the relevant specification of the source system.

In the case of inter-MSC handover the term "the MSC" in this sub-clause is taken to mean the relevant MSC in the handover operation.

The inter-system handover procedures are specified in the following sub-clause. All messages concerned with inter-system handover are sent using the connection oriented mode of the SCCP.

### 3.1.5b.2 Inter-System Handover Resource Allocation

In the case of a handover from *Iu mode* (GERAN or UTRAN) to *A/Gb mode*, the *Inter-System Information* information element is used to pass Field Elements from the new BSS to the old system. The information in the *Inter-System Information* information element is transparent for the MSC. When the *Inter-System Information* information element is present in the HANDOVER REQUEST ACKNOWLEDGE message or the HANDOVER FAILURE message, the MSC may pass it to the old system.

The new BSS may provide information about the traffic load of the target cell by including the *Downlink Cell Load Information* and/or the *Uplink Cell Load Information* field elements in the *Inter-System Information* information element. The old system may use the information to update the information about the load on the new cell, which may be used in the initiation of future cell load based handover procedures. This information shall represent the traffic load in the cell assuming a successful completion of the handover procedure in progress.

### 3.1.5c BSS Internal Handover with MSC support

This section is relevant only if an IP based user plane interface is supported. The three internal handover procedures (Internal Handover Preparation, Internal Handover Execution and Internal Handover Enquiry), described in the following sections, use the existing SCCP connection.

#### 3.1.5c.1 Internal Handover Preparation

The details of the radio information as far as handover is concerned are given in 3GPP TS 24.008.

When the BSS detects that e.g. a radio reason exists for an internal handover, but a compatible Codec Type or Codec Configuration can not be allocated in the target cell or the A-Interface Type has to be changed, or the Redundancy Level on the A-Interface of an ongoing data or fax call has to be changed, then an Internal Handover Preparation procedure is initiated by BSS.

This Internal Handover Preparation is initiated by generating an INTERNAL HANDOVER REQUIRED message and sending it from the BSS to the MSC.

The INTERNAL HANDOVER REQUIRED message contains the following information elements:

- Message Type.
- Cause.
- Cell Identifier (target cell)
- Codec List (BSS Supported) (in target cell)
- AoIP Transport Layer Address (target cell), if the BSS prefers an IP-based target A-Interface Type

The "Cause" field indicates the reason for the INTERNAL HANDOVER REQUIRED message e.g. "uplink quality poor", "Redundancy Level not adequate" indicated by BSS.

The "Cell Identifier" indicates a target cell controlled by the same BSS. The target cell can be the same as the source cell.

The "Codec List (BSS Supported)" contains the up-to-date codec capabilities in the target cell.

The "AoIP Transport Layer Address" contains the UDP/IP termination at the BSS corresponding to the radio channel in the target cell. It is only included, if the BSS prefers an IP-based target A-Interface Type. The new AoIP Transport Layer Address may be identical to the old AoIP Transport Layer Address.

The Internal Handover Preparation procedure terminates, if one of the following conditions is met:

- An INTERNAL HANDOVER COMMAND message is received from the MSC; or
- A RESET message (or RESET CIRCUIT message or RESET IP RESOURCE message) is received; or
- An INTERNAL HANDOVER REQUIRED REJECT is received; or
- An ASSIGNMENT REQUEST is received; or
- The Timer T25 expires without any answer from the MSC, or
- All communication is lost with the MS as defined in 3GPP TS 44.018, and the transaction is abandoned; or
- The transaction ends, e.g. due to call clearing.

If the Internal Handover Execution procedure cannot be carried out, then the MSC shall inform the BSS by sending an INTERNAL HANDOVER REQUIRED REJECT message.

To continue with the Internal Handover Execution procedure, the MSC generates the INTERNAL HANDOVER COMMAND message as a response to the INTERNAL HANDOVER REQUIRED message.

The Internal Handover Execution procedure can now proceed and this is given in sub-clause 3.1.5c.2.

#### 3.1.5c.1.1 Internal Handover Required Reject

If the requested resource (e.g. Codec Type or Codec Configuration, A-Interface Type, etc.) indicated in the INTERNAL HANDOVER REQUIRED message is not available, then an INTERNAL HANDOVER REQUIRED REJECT message shall be returned to the BSS. The appropriate failure cause will be included in the message (Cause value: "Requested Codec Type or Codec Configuration unavailable", "Requested A-Interface Type unavailable", "Requested Codec Type or Codec Configuration not supported" or "Requested A-Interface Type not supported", "Requested Redundancy Level not supported" or "Requested Redundancy Level not available").

#### 3.1.5c.2 Internal Handover Execution

The Internal Handover Execution procedure in the context of the BSS/MSC interface is the procedure whereby an MSC instructs an MS to tune to a new dedicated radio resource or to a group of radio resources, which may be on a different cell.

The MSC generates the INTERNAL HANDOVER COMMAND message as a response to the INTERNAL HANDOVER REQUIRED message. The INTERNAL HANDOVER COMMAND message generated by the MSC shall contain the "Speech Codec (MSC Chosen)" and if an IP based user plane A-Interface is chosen, also the "AoIP Transport Layer Address (MGW)". The "Speech Codec (MSC Chosen)" shall contain one Codec Type (or, in case of AMR-NB or AMR-WB, possibly more compatible Codec Types) included in the "Speech Codec List (BSS Supported)" received in the INTERNAL HANDOVER REQUIRED message, with one Codec Configuration (or the same or compatible Codec Configuration(s) in case of more compatible Codec Types) and with one A-Interface Type, that exactly correspond to the indication in the "Speech Codec List (BSS Supported)".

If Local Call Local Switch (LCLS) is supported by the core network, the MSC may include the LCLS-Connection-Status-Control IE in the INTERNAL HANDOVER COMMAND message.

Upon reception of the INTERNAL HANDOVER COMMAND message, the BSS shall only through-connect the two parties if either:

- indicated to do so in the INTERNAL HANDOVER COMMAND message by receiving the LCLS-Connection-Status-Control IE set to "Connect" and the other call leg has previously received LCLS-Connection-Status-Control IE set to "Connect".
- or the LCLS-Connection-Status-Control IE is not present in the INTERNAL HANDOVER COMMAND message and the BSS previously in another BSSAP message received the LCLS-Connection-Status-Control IE set to "Connect" for this call leg and the other call leg has previously received LCLS-Connection-Status-Control IE set to "Connect".

The BSS will construct and send the appropriate radio assignment or handover messages, if required (i.e. if the radio resource(s) has/have to be changed), as described in 3GPP TS 44.018. The INTERNAL HANDOVER COMMAND message includes sufficient information to allow the BSS to construct the necessary layer 3 radio messages.

The radio interface HANDOVER COMMAND or ASSIGNMENT COMMAND message is sent by the BSS to the concerned MS, once the BSS has received the INTERNAL HANDOVER COMMAND message and the remaining resources are allocated in the BSS.

When the MS accesses the radio resource(s) of the new channel with a HANDOVER ACCESS burst, or anyway as soon as the main signalling link is established then the BSS may send a HANDOVER DETECT message to the MSC.

When the MS is successfully in communication with the network, i.e. the RR message HANDOVER COMPLETE or ASSIGNMENT COMPLETE has been received from the MS, the BSS shall immediately send a HANDOVER COMPLETE message to the MSC and terminate the procedure. Changes of the chosen encryption algorithm shall be indicated in the HANDOVER COMPLETE message in case of an "Internal Handover Execution" procedure, if the encryption algorithm has been changed by the BSS. The Information Elements "Speech Codec (Chosen)" shall be included in case of an "Internal Handover Execution" procedure. The Information Element "Codec List (BSS Supported)" may be included in case of an "Internal Handover Execution" procedure to indicate up-to-date BSS capabilities after the handover.

If local switching is requested by the MSC, then the BSS shall inform the MSC of the local switch establishment outcome by including the LCLS-BSS-Status IE with the correct LCLS connection status value according to sub-clause 3.2.2.119 within the HANDOVER COMPLETE message. The BSS shall also notify the MSC serving the other call leg if the LCLS connection status is changed for this call leg, see sub-clause 3.1.33.5.

The sending of the HANDOVER COMPLETE message will implicitly release the old dedicated resource(s) at the BSS and old resources in the MSC.

The Internal Handover Execution procedure shall not be interrupted by a Handover Required message.

The relevant radio interface layer 3 procedures are described in 3GPP TS 24.008.

### 3.1.5c.2.1 Internal Handover failure

The BSS may not be able to use the terrestrial resource (that is either a terrestrial circuit or an IP based user plane interface) that the MSC has indicated in the Internal Handover Command. In this case a BSSAP HANDOVER FAILURE message will be returned with the Cause value set to: "requested terrestrial resource unavailable".

If a radio interface HANDOVER FAILURE message is received from the MS on the old channel, the BSS shall then send to the MSC the BSSMAP HANDOVER FAILURE message. If the radio interface HANDOVER FAILURE message is the result of the MS returning to the old channel after failing to establish on the new channel, then the cause value "radio interface failure, reversion to old channel" shall be included in the BSSMAP HANDOVER FAILURE message. Furthermore, it is recommended that the air interface RR cause be included as well in this message.

The BSSMAP HANDOVER FAILURE message from the BSS (with any cause value) terminates the Internal Handover Execution procedure. The call between the MS and the BSS and between the BSS and the MSC shall continue as if there had been no handover attempt.

Further actions in the MSC or in the BSS concerning handover depend on the handover algorithms which is operator dependent.

### 3.1.5c.2.2 Abnormal Conditions

Whilst the Internal Handover Execution procedure is in operation, any other messages received at the BSS relating to this connection and concerning assignment, handover, or cipher mode control should be discarded.

Whilst the Internal Handover execution procedure is in operation the BSS should not attempt to invoke any other procedure related to this call, e.g. not send HANDOVER REQUIRED or INTERNAL HANDOVER REQUIRED.

### 3.1.5c.3 Internal Handover Enquiry

The MSC may trigger the "Internal Handover Execution" procedure to ensure that the best fit of dedicated resource(s) (Codec Type, Codec Configuration, Redundancy Level and A-Interface Type) are allocated to the ongoing call (e.g. to



re-establish TrFO). The decision in the MSC to trigger this procedure is linked to implementation dependent strategies, based on the information received from the MS and from the network.

The Internal Handover Preparation procedure is triggered by the MSC with the transmission of an INTERNAL HANDOVER ENQUIRY message to the BSS.

The INTERNAL HANDOVER ENQUIRY message shall contain in the "Speech Codec (MSC Chosen)" Information Element the details of the resource(s) (Codec Type, Codec Configuration and Interface Type) preferred by the MSC. The BSS shall use the information provided in the "Speech Codec (MSC Chosen)" Information Element to decide a possible target cell that meets such indications.

NOTE: The target cell can be the cell where the voice call is ongoing.

Upon reception of the INTERNAL HANDOVER ENQUIRY message, if the BSS finds an appropriate target cell that meets the needed radio requirements and is compatible with the preferences in the "Speech Codec (MSC Chosen)" Information Element, the BSS shall initiate the Internal Handover Preparation procedure by sending the INTERNAL HANDOVER REQUIRED message as described in sub-clause 3.1.5c.1, with Cause "Response to an INTERNAL HANDOVER ENQUIRY message".

The BSS may respond to an INTERNAL HANDOVER ENQUIRY message with an HANDOVER FAILURE message with cause value "INTERNAL HANDOVER ENQUIRY reject". For example the BSS cannot find an appropriate target cell that meets the needed radio requirements and is compatible with the preferences in the "Speech Codec (MSC Chosen)" Information Element contained in the INTERNAL HANDOVER ENQUIRY message.

### 3.1.6 Internal Intra-Cell Handover Procedure

The definition of internal intra cell handover is given in sub-clause 5.

It is optional that a BSS support internal intra-cell handover. However if it is supported, it should be as follows:

It should be possible to inhibit internal intra-cell handover at an BSS that supports it by operation and maintenance command.

Internal intra-cell handover occurs between channels on the same cell. It is decided and executed autonomously by the BSS, so that no message is generated at the BSS-MSC interface, until the completion of the handover execution, when the BSS sends a HANDOVER PERFORMED message over the SCCP and terrestrial resources that are presently assigned to that call. Changes in type of resources (for instance channel rate change, speech version change, ciphering algorithm change) are indicated in the HANDOVER PERFORMED message.

If an IP based user plane A-interface is supported and compressed speech over IP is in use, then the BSS shall not perform any autonomous "internal intra-cell handover" procedure with a change of Codec Type or Codec Configuration or Redundancy Level to an incompatible one. When the speech transcoder resources are not allocated within the BSS or the Redundancy Level or the A-Interface Type has to be changed, then the BSS shall use the "BSS Internal Handover" Procedure. The decision process in the BSS is based on the internally available radio and resource parameters taking into account the previously received information from the MSC in the ASSIGNMENT REQUEST or HANDOVER REQUEST.

The relevant radio interface layer 3 procedures (dedicated channel assignment) are described in 3GPP TS 24.008.

In the case of group calls the BSS may perform an intra-cell handover for a talker from a dedicated channel to a group call channel, in this case the HANDOVER PERFORMED message is sent by the BSS over the SCCP connection that was previously assigned to the talker, followed by a CLEAR REQUEST with the cause "Joined group call channel", the MSC shall release the dedicated A interface resources.

In the case of group calls the BSS may perform an Intra-cell handover for a talker from a Group call channel to a dedicated channel, in this case the BSS performs external handover.

If local switching was requested by the MSC before the initiation of the internal intra-cell handover procedure, then the BSS shall maintain local switching on the new channel according to the most recently received LCLS-Configuration IE and (if received) LCLS-Connection-Status-Control IE and inform the MSC of the local switch outcome by including the LCLS-BSS-Status IE with the correct LCLS connection status value according to sub-clause 3.2.2.119 within the HANDOVER PERFORMED message. The BSS shall also notify the MSC serving the other call leg if the LCLS connection status is changed for this call leg, see sub-clause 3.1.33.5.

### 3.1.7 Internal Inter-Cell Handover Procedure

The definition of internal inter-cell handover is given in sub-clause 5.

It should be possible to inhibit internal inter-cell handover at a BSS that supports it by operation and maintenance command.

Multi cell BSSs would normally be expected to support internal inter-cell handover, however it is optional that they do so. However if it is supported, it should be as follows:

Internal inter-cell handover occurs between channels pertaining to different cells of the same BSS. It is decided and executed autonomously by the BSS, so that no message is generated at the BSS-MS interface, until the completion of the handover execution, when the BSS sends a HANOVER PERFORMED message over the SCCP and terrestrial resources that are presently assigned to that call. Changes in type of resources (for instance channel rate change, speech version change, ciphering algorithm change) are indicated in the HANOVER PERFORMED message.

If an IP based user plane A-interface is supported and compressed speech over IP is in use, then the BSS shall not perform any autonomous "Internal inter-cell handover" procedure with a change of Codec Type or Codec Configuration or Redundancy Level to an incompatible one. When the speech transcoder resources are not allocated within the BSS or the Interface Type has to be changed, then the BSS shall use the "BSS Internal Handover" procedure.

A special case of internal handover occurs when the handover is triggered by the assignment procedure, e.g. directed retry. In this case the HANOVER PERFORMED message need not be sent as the equivalent response is provided by the ASSIGNMENT COMPLETE message.

The decision process in the BSS is based on the internally available radio and resource parameters taking into account the previously received information from the MSC in the ASSIGNMENT REQUEST or HANOVER REQUEST.

The relevant radio interface layer 3 procedures (for handover) are described in 3GPP TS 24.008.

Internal inter-cell handover for group calls may be performed from either dedicated to dedicated channels, or dedicated to group call channels, or group call to group call channels.

In the case of group calls, the BSS may perform an internal inter-cell handover for a talker from a dedicated channel to a Group call channel, in this case the HANOVER PERFORMED message is sent by the BSS over the SCCP connection that was previously assigned to the talker. The BSS will send a CLEAR REQUEST with the cause "Joined group call channel".

In the case of group calls, the BSS may perform an internal inter-cell handover for a talker from a group call channel to a Group call channel, in this case the HANOVER PERFORMED message is sent by the BSS over the SCCP connection that was previously assigned to the talker.

In the case of internal inter-cell handover the BSS, when localised service area is supported, will indicate the LSA identity of the target cell in the HANOVER PERFORMED message if it corresponds to one of the LSA identities received in the latest LSA INFORMATION or the HANOVER REQUEST messages.

If local switching was requested by the MSC before the initiation of the internal inter-cell handover procedure, then the BSS shall maintain local switching on the new channel according to the most recently received LCLS-Configuration IE and (if received) LCLS-Connection-Status-Control IE and inform the MSC of the local switch outcome by including the LCLS-BSS-Status IE with the correct LCLS connection status value according to sub-clause 3.2.2.119 within the HANOVER PERFORMED message. The BSS shall also notify the MSC serving the other call leg if the LCLS connection status is changed for this call leg, see sub-clause 3.1.33.5.

### 3.1.8 Handover Candidate Enquiry

The purpose of this procedure is to allow the MSC to ascertain if it is possible to handover any MSs that are currently being served by a particular cell to another nominated cell. The procedure uses both global and dedicated resource messages, and is relevant to an individual cell.

The algorithm in which a MSC decides on starting a handover enquiry procedure is operator dependent.

### 3.1.8.1 Successful Operation

The procedure operates as follows:

The MSC sends a HANOVER CANDIDATE ENQUIRE message to a BSS. The message indicates that the MSC wishes the BSS to identify handover candidates in a particular cell, that can be handed over to other nominated cells. The maximum number of candidates is also indicated to the BSS.

For each selected MS candidate the BSS will send to MSC a single, once only, HANOVER REQUIRED message (not guarded by timer T7), over each of the appropriate SCCP connections. If the BSS was already generating HANOVER REQUIRED messages for a selected MS then the BSS will continue to do so. However the Cause IE of the next HANOVER REQUIRED message (at the expiry of timer T7) will be set to "Response to MSC invocation" to indicate that the message is generated in response to a HANOVER CANDIDATE ENQUIRE message. But as this HANOVER REQUIRED was already being generated before the handover enquiry procedure was started, that HANOVER REQUIRED would be guarded by timer T7. So in the instance of next expiry of timer T7, the BSS shall continue sending HANOVER REQUIRED message but the Cause IE value shall revert back to the original Cause IE value.

When the last HANOVER REQUIRED message has been sent for all the selected MS candidates, the BSS returns to the MSC a HANOVER CANDIDATE RESPONSE message giving the number of candidates identified, and terminating the handover enquiry procedure.

Only one handover enquiry procedure may be invoked on any given cell at any one time.

### 3.1.8.2 Abnormal conditions

If at the BSS a HANOVER CANDIDATE ENQUIRE message is received when a handover enquiry procedure has already been invoked then the new HANOVER CANDIDATE ENQUIRE message shall be discarded.

## 3.1.9 Release of Radio Resource And Terrestrial Resource

### 3.1.9.1 Release Due To Transaction Completion

**NOTE:** This sub-clause does not apply to group call channels and their related terrestrial resources. For the release of these resources due to the completion of a VGCS/VBS call, see sub-clause 3.1.9.1a.

For a dedicated connection, the release of assigned radio resources at the end of a transaction will take place as follows:

Release negotiation will take place directly between the MS and MSC using transparent messages via the DTAP in the BSS (see 3GPP TS 24.008). The MSC will then send a BSSMAP CLEAR COMMAND, indicating that the radio resource(s) should be released. After the BSSMAP CLEAR COMMAND has been sent, the MSC shall not send further BSSAP connection oriented messages on this particular connection, except CLEAR COMMAND.

If the BSS allocates the A interface circuits, the MSC shall release the circuit allocated to the connection, if any, before sending the CLEAR COMMAND.

When the BSS receives the CLEAR COMMAND:

- the guard timer defined in 3GPP TS 24.008 is started and clearing on the radio interface initiated.
- the BSS marks any assigned terrestrial resources as idle and returns a CLEAR COMPLETE message to the MSC. (The BSS need not wait for the radio channel release to be completed or for the guard timer to expire before returning the CLEAR COMPLETE message.)
- the BSS marks any assigned terrestrial resources as idle and returns a CLEAR COMPLETE message to the MSC. (The BSS need not wait for the radio channel release to be completed or for the guard timer to expire before returning the CLEAR COMPLETE message.)

During the release of an RR connection the MSC should indicate to the BSS whether the RR connection was established as a result of CS fallback if such knowledge is available in the MSC.

If the MSC allocates A interface circuits, on receipt of CLEAR COMPLETE, the MSC releases any assigned terrestrial resources.

### 3.1.9.1a Release of radio resources and the terrestrial resources for VGCS/VBS calls:

When a VGCS/VBS call is to be released, the MSC shall send a BSSMAP CLEAR COMMAND message via each VGCS/VBS Resource Controlling SCCP connection to the BSS.

When the BSS receives the CLEAR COMMAND on a VGCS/VBS resource controlling SCCP connection, the guard timer defined in 3GPP TS 44.018 is started and clearing on the radio interface initiated. The BSS returns a CLEAR COMPLETE message to the MSC. (The BSS need not wait for the radio channel release to be completed or for the guard timer to expire before returning the CLEAR COMPLETE message.) If A-interface circuit sharing is used, the BSS marks the assigned terrestrial resources as idle only after it has sent a CLEAR COMPLETE message on each resource controlling SCCP connection associated with the call.

When all terrestrial resources associated with the VGCS/VBS resource controlling SCCP connections towards a particular BSS have been released, the MSC shall send the BSSMAP CLEAR COMMAND message via the VGCS/VBS Call Controlling SCCP connection to the BSS to release the associated call controlling resources. When the BSS receives the CLEAR COMMAND it shall release the associated resources, it shall mark them as idle and return a CLEAR COMPLETE message to the MSC.

After sending a BSSMAP CLEAR COMMAND on an SCCP connection, the MSC shall not send further BSSAP connection oriented messages on that connection except CLEAR COMMAND messages.

If the BSS allocates the A interface circuits, the MSC shall release the circuit allocation to the connection, if any, before sending the CLEAR COMMAND.

If the MSC allocates A-interface circuits, the MSC releases the circuit allocation to the connection on receipt of a CLEAR COMPLETE message.

### 3.1.9.2 Release due to BSS generated reason

If a radio channel release for a radio resource that is not related to a voice group or broadcast call is required because of a BSS generated reason (e.g. "O and M intervention", "equipment failure"), then the BSS shall generate a CLEAR REQUEST message towards the MSC. This message shall include a Cause Information Element, indicating the reason for the failure.

If transmission from the non VGCS/VBS MS is lost then a CLEAR REQUEST message shall be sent to the MSC.

On receipt of a CLEAR REQUEST for a dedicated resource the MSC shall initiate the release, as defined above, by sending a CLEAR COMMAND message. On receipt of the CLEAR COMMAND the related radio resources shall be released by the BSS. The procedure is always terminated with a CLEAR COMPLETE to the MSC.

If the release of a radio resource that is associated with a voice group or broadcast call is required due to a BSS generated reason other than due to loss of contact of the VGCS talker or VBS originator, and the network does not support either group call re-establishment by the BSS or A-interface link sharing, then

- if the radio resource to be released is that of the group channel in a cell other than that of the current VGCS talker or that of the VBS originator, the BSS shall send a CLEAR REQUEST message to the MSC indicating the reason for the failure.
- if the radio resource to be released is that of the group channel in the cell of the VGCS talker which is on a dedicated channel or in the cell of the VBS originator, the BSS shall send a CLEAR REQUEST message to the MSC indicating the reason for the failure.
- if the radio resource to be released is that of the current VGCS talker which is on a dedicated channel, BSS shall send an UPLINK RELEASE INDICATION message to the MSC indicating the reason for the failure. On receipt of an UPLINK RELEASE INDICATION message with a cause value other than "Call control" or "Radio interface failure", the MSC shall initiate the release of the radio and terrestrial resources by sending a CLEAR COMMAND message on the dedicated SCCP connection.
- if the radio resource to be released is that of the current VGCS talker which is on a group channel, the BSS shall send an UPLINK RELEASE INDICATION message to the MSC indicating the reason for the failure. On receipt of an UPLINK RELEASE INDICATION message with a cause value other than "Call control" or "Radio interface failure", the MSC shall initiate the release of the radio and terrestrial resources by sending a CLEAR COMMAND message on the VGCS/VBS resource controlling SCCP connection.

- if the radio resource to be released is that of the VBS originator, the BSS shall send a CLEAR REQUEST message to the MSC indicating the reason for the failure. On receipt of a CLEAR REQUEST message the MSC shall initiate clearing of the broadcast call.

If a radio channel release of the radio resource that is associated to a voice group or broadcast call is required due to a BSS generated reason other than due to loss of contact of the VGCS talker or VBS originator, and the network supports group call re-establishment by the BSS or A-interface link sharing, then:

- if the radio resource to be released is that of the group channel in a cell other than that of the current VGCS talker or that of the VBS originator, the BSS shall send a VGCS/VBS ASSIGNMENT STATUS message to the MSC indicating cell released for the group call, and then releases the radio resource. If A-interface link sharing is being used the VGCS/VBS ASSIGNMENT STATUS message is sent after expiry of timer T<sub>ast</sub>.
- if the radio resource to be released is that of the group channel in the cell of the VGCS talker which is on a dedicated channel or in the cell of the VBS originator, the BSS shall send a VGCS/VBS ASSIGNMENT STATUS message to the MSC indicating cell released for the group call, and then releases the radio resource. If A-interface link sharing is being used the VGCS/VBS ASSIGNMENT STATUS message is sent after expiry of timer T<sub>ast</sub>.
- if the radio resource to be released is that of the current VGCS talker which is on a dedicated channel, the BSS shall send an UPLINK RELEASE INDICATION message to the MSC indicating the reason for the failure. On receipt of an UPLINK RELEASE INDICATION message with a cause value other than "Call control" or "Radio interface failure", the MSC shall initiate the release of the radio and terrestrial resources by sending a CLEAR COMMAND message on the dedicated SCCP connection.
- if the radio resource to be released is that of the current VGCS talker which is on a group channel, the BSS shall send an UPLINK RELEASE INDICATION message with an appropriate cause value. The BSS shall also send a VGCS/VBS ASSIGNMENT STATUS message to the MSC indicating cell released for the voice group or broadcast call, and then release the radio resource for the group channel. When A-interface link sharing is being used the VGCS/VBS ASSIGNMENT STATUS message is sent after expiry of timer T<sub>ast</sub>.
- if the radio resource to be released is that of the VBS originator, the BSS shall send a CLEAR REQUEST message to the MSC indicating the reason for the failure. On receipt of a CLEAR REQUEST message the MSC shall initiate clearing of the broadcast call.

On receipt of a CLEAR REQUEST on the VGCS/VBS resource controlling SCCP connection, the MSC shall initiate the release, as defined above, by sending a CLEAR COMMAND message. On receipt of the CLEAR COMMAND the radio resources related to this cell shall be released by the BSS. If the terrestrial resource is not configured for A-interface circuit sharing then the resource shall be released by the MSC or marked as idle by the BSS. For the case that the terrestrial resource is configured for A-interface circuit sharing then it will only be released by the MSC or marked as idle by the BSS if there are no other VGCS/VBS resource controlling SCCP connections that are sharing this resource. The resource controlling SCCP connection for the cell shall be released. The procedure is always terminated with a CLEAR COMPLETE to the MSC.

If transmission from a VGCS talker that was on the group call channel is lost then the BSS shall indicate the uplink being released by sending an UPLINK RELEASE INDICATION message with cause value "Radio interface failure". the MSC shall not start the clearing sequence, and the resources at the BSS are not released.

If transmission from a VGCS talker that was on a dedicated channel is lost, then the BSS shall indicate the uplink being released by sending an UPLINK RELEASE INDICATION message with cause value "Radio interface failure". The MSC shall initiate the release of the resources associated with the talker by sending a CLEAR COMMAND message, as described above.

If transmission from a VBS originator is lost then the BSS shall send a CLEAR REQUEST message with cause value "Radio interface failure". On receipt of a CLEAR REQUEST message the MSC shall initiate clearing of the broadcast call.

In the case of a group call talker the BSS may move the mobile on to a group call channel, in this case the BSS shall initiate a release of A interface resources by sending a CLEAR REQUEST with the cause "Joined group call channel". The MSC in its turn shall release the dedicated resources associated with the talker.

If the BSS sends a CLEAR REQUEST with the cause different than "Joined group call channel" for resources associated with the uplink, then the MSC shall assume uplink indicated as released.

### 3.1.9.3 Release due to successful handover

If a radio channel release is required because of a handover being successfully completed on another BSS, then the resources at the old BSS are released by the MSC using the clearing sequence with cause value "handover successful".

In the case of handover of a group call talker from a group call channel the MSC shall send a HANOVER SUCCEDED message to the old BSS.

### 3.1.9.4 Release due to uplink release

If a talker on dedicated connection releases its uplink the BSS shall inform the MSC by an UPLINK RELEASE INDICATION message with cause value "Call control". Then the resources at the BSS are released by the MSC using the clearing sequence. The BSS is allowed to release the radio resources before the MSC initiates the clearing procedure.

If a talker on group call channel releases its uplink, the BSS shall inform the MSC by an UPLINK RELEASE INDICATION message with cause value "Call control". In this case the MSC shall not start the clearing sequence, and the resources at the BSS are not released. The BSS shall initiate the radio interface uplink free procedure.

## 3.1.10 Paging

PAGING messages for all MSs shall be sent via the BSSMAP as a connectionless message. These will include the IMSI of the MS to allow derivation of the paging population number; they may also include an indication of which combination of channels will be needed for the subsequent transaction related to the paging. This type of PAGING message will then be stored and a corresponding radio interface paging message transmitted over the radio interface at the appropriate time.

It should be noted that each PAGING message on the MSC-BSS interface relates to only one MS and therefore the BSS has to pack the pages into the relevant 3GPP TS 24.008 radio interface paging message.

If a radio interface PAGING RESPONSE message is received then the relevant connection is set up towards the MSC as described in 3GPP TS 48.002 and the radio interface PAGING RESPONSE message is passed to the MSC in a COMPLETE LAYER 3 INFORMATION message.

If an IP based user plane interface is supported the COMPLETE LAYER 3 INFORMATION message shall contain the Information Element "Codec List (BSS Supported)".

A single PAGING message across the MSC to BSS interface contains information on the cells in which the page shall be broadcast.

If the VGCS/VBS flag is set to zero, this indicates that the mobile station to be paged is not a member of any VGCS/VBS group and it is thus not necessary to perform in band paging for this mobile station over the FACCH channel for any VGCS/VBS group.

If the mobile station is a member of at least one VBS/VGCS group, then the MSC shall indicate the paging cause in the Paging Information IE and shall include this IE in the PAGING message.

## 3.1.11 Trace Invocation

The purpose of the trace invocation procedure is to inform the receiving entity that it should begin producing a trace record on this particular transaction.

The trace is invoked either by the MSC sending a MSC INVOKE TRACE message to the BSS or by the BSS sending a BSS INVOKE TRACE message.

The events and parameters to be recorded are indicated in the "Trace type" information element.

A "Forwarding indicator" element may be used in the BSS INVOKE TRACE to indicate if the trace is to be continued after handover to another BSS. If thus indicated, The MSC should forward the BSS INVOKE TRACE to the BSS-B and also store it to send to any subsequent BSS during the lifetime of the call.

The remaining elements, when received, are to be passed transparently to the OMC receiving the trace record.

The element "OMCId", if present, indicates the OMC to which the record is destined.

In sending the BSS INVOKE TRACE message, the BSS may allocate and include a "BSS transaction reference". Similarly in the MSC INVOKE TRACE message, the MSC may allocate and include an "MSC transaction reference" (typically a call reference). The transaction reference is contained in the information element "TransactionId".

The message includes a trace reference which is allocated by the entity which triggered the trace.

The element "TriggerId", if present, indicates the entity which triggered the trace.

The trace reference, triggerId and transactionId Information Elements are used to tag the trace record to allow simpler construction of the total record by the entity which combines trace records.

The messages are not acknowledged and are sent as a connection oriented message on the connection on which a trace is required.

### 3.1.12 Flow Control

These procedures are defined to give some degree of flow control. At the BSS processor overload and CCCH scheduler overload are catered for, and at the MSC processor overload is catered for.

#### 3.1.12.1 Philosophy

The philosophy used is to stem the traffic at source with known effect on the service. The algorithm used is:

- On receipt of the first OVERLOAD message or signalling point congested information, the traffic is reduced by one step. At the same time, timers T5 (T17) and T6 (T18) are started. During T5 (T17) all received overload messages or signalling point congested information are ignored in order not to reduce the traffic too rapidly. Reception of an OVERLOAD message or signalling point congested information after expiry of T5 (T17) but still during T6 (T18) , will decrease the traffic load by one more step, and restart T5 (T17) and T6 (T18).
- This step by step reduction of traffic is continued until maximum reduction is obtained by arriving at the last step. If T6 (T18) expires (i.e. no OVERLOAD message or signalling point congested information is received during T6 (T18)) the traffic will be increased by one step and T6 (T18) will be started, unless full load has been resumed.

NOTE: Timers T5 and T6 are running in the MSC whilst Timers T17 and T18 are running in the BSS.

- The number of steps and the method of reducing the load is considered to be an implementation specific function.

There may be other traffic control mechanisms from O and M activities occurring simultaneously.

#### 3.1.12.2 Processor Overload at the MSC

The MSC can indicate to the BSS that it is in a congested state by sending an OVERLOAD message. This is sent as a connectionless global message.

At the BSS receipt of this message causes the reduction of random access traffic using the method described in sub-clause 3.1.12.1.

For example, the amount of random access traffic could be reduced by using the access control class in the system information message of 3GPP TS 24.008.

#### 3.1.12.3 Processor/CCCH overload at the BSS

If the CCCH scheduler at the BSS is overloaded (queue passed a predefined threshold) then the BSS sends an OVERLOAD message to the MSC (or, if the network supports "Intra domain connection of RAN nodes to multiple CN nodes" (see 3GPP TS 23.236 [48]) to the appropriate MSCs) with the appropriate cause (Cause value: "CCCH overload") and indicating the cell in question.

If the BSS processing is overloaded then the BSS sends an OVERLOAD message with the Cause value: "processor overload".

The MSC originated traffic is reduced in accordance with the method described in sub-clause 3.1.12.1.

#### 3.1.12.4 Message throughput congestion

If the lower layers of the protocol become congested then it is assumed that the MTP congestion indication will take place (see 3GPP TS 48.002) and the source of the traffic will receive primitives from the transport protocols resulting in it reducing the generated load.

A suitable method to achieve this reduction could be based on that given in sub-clause 3.1.12.1.

### 3.1.13 Classmark Handling Procedures

#### 3.1.13.1 Classmark request procedure

The purpose of this procedure is to allow the MSC to trigger a classmark updating procedure. This is done by sending a CLASSMARK REQUEST message to the BSS on the appropriate SCCP connection. When receiving this message the BSS shall initiate the appropriate actions on the radio path.

#### 3.1.13.2 Classmark updating procedure

The purpose of the classmark updating procedure is to inform the receiving entity about classmark information received from the MS.

At any point when an SCCP connection has been established for BSSAP messages, the BSS must be able to send to the MSC a CLASSMARK UPDATE message if a classmark update is received from the MS. This message contains information on several transmission parameters relevant to the MS in communication with the network.

If the MSC has already initiated a handover for the concerned MS by sending a HANDOVER REQUEST message when the CLASSMARK UPDATE message is received, the MSC shall send a CLASSMARK UPDATE message to the target BSS when the MS is successfully in communication with the network on the new (main) channel. If this CLASSMARK UPDATE message is received in the target BSS after a new classmark has been received from the Mobile Station the CLASSMARK UPDATE message from the MSC shall be ignored.

This message is sent as a BSSAP message over the appropriate SCCP connection.

This procedure will be used where the power class of the MS changes or if the network requests the MS to send the classmark information whilst the MS has one or more dedicated resources.

The procedure will also be used to send classmark information to the MSC if the MS immediately after initial L3 message sends additional classmark information. In this case the BSS may as an option suppress or delay the sending of the CLASSMARK UPDATE message to the MSC.

### 3.1.14 Cipher Mode Control

#### 3.1.14.1 Successful Operation

The cipher mode control procedure allows the MSC to pass cipher mode information to the BSS to select and load the user data and signalling encryption device with the appropriate key.

This is achieved by sending the BSS a CIPHER MODE COMMAND message. Receipt of the message at the BSS will cause the generation of a radio interface CIPHERING MODE COMMAND message and, if applicable, invoke the encryption device and start stream ciphering as described in 3GPP TS 24.008 and 3GPP TS 43.020.

If within the CIPHER MODE COMMAND, the signalling element "Cipher response mode" is present and indicates "IMEI must be included by the Mobile Station", then the BSS shall request in the radio interface message CIPHERING MODE COMMAND the Mobile Station to include its IMEI in the radio interface CIPHERING MODE COMPLETE message (see 3GPP TS 24.008).

In the CIPHER MODE COMMAND the MSC specifies which of the ciphering algorithms may be used by the BSS. The BSS then selects an appropriate algorithm, taking into account the MS ciphering capabilities. The CIPHER MODE COMPLETE message returned to the MSC indicates the chosen ciphering algorithm. The set of permitted ciphering



algorithms specified in the CIPHER MODE COMMAND shall remain applicable for subsequent Assignments and Intra-BSS Handovers.

The CIPHER MODE COMMAND and CIPHER MODE COMPLETE messages are sent as connection oriented messages via the appropriate SCCP connection.

Receipt of the radio interface CIPHERING MODE COMPLETE message (or other correctly deciphered layer 2 frame) from the radio interface is used internally within the BSS to achieve radio interface ciphering synchronisation (see 3GPP TS 24.008). When the BSS receives the radio interface CIPHERING MODE COMPLETE from the MS a CIPHER MODE COMPLETE message is returned to the MSC. If the CIPHERING MODE COMPLETE message received on the radio interface contained more than two octets, then the BSS shall include in the BSSMAP CIPHER MODE COMPLETE message a "Layer 3 message contents" signalling element containing octets 3 up to n (where n is the length of that CIPHERING MODE COMPLETE radio interface message) of that radio interface CIPHERING MODE COMPLETE message.

### 3.1.14.2 Abnormal Conditions

If the BSS is unable to support the ciphering algorithm specified in the CIPHER MODE COMMAND message then it shall return a CIPHER MODE REJECT message with Cause value "Ciphering algorithm not supported". A CIPHER MODE REJECT message shall also be returned if the MSC requests a change of ciphering algorithm when ciphering is already active.

### 3.1.15 General SCCP Abnormal Conditions

If a user-out-of-service information or signalling-point-inaccessible information is received by the BSSAP or BSSOMAP no new attempt to establish SCCP connections towards the affected point code will be started until the corresponding user-in-service information or signalling-point-accessible information is received.

When a user-out-of-service information or signalling-point-inaccessible is received by the BSS an optional timer may be started. When the timer expires all the SCCP connections towards the affected point code will be released. When the user-in-service or signalling-point-accessible is received, the timer is stopped.

If for any reason an SCCP connection is released, the optional timer expires or a connection refusal is received while any of the BSSAP procedures are being performed or while a dedicated resource is still allocated the following actions are taken:

#### **At BSS:**

The radio resources associated with the SCCP connection are cleared by an appropriate radio procedure.

Any BSS procedure relating to that connection is abandoned.

The resources allocated to the call associated to the connection are released.

#### **At MSC:**

The call associated with the SCCP connection is cleared as soon as possible.

At the BSS, communication over assigned radio channels shall be assumed to be continuing until either the SCCP connection is lost, a clearing sequence is received, or no signal is received from an MS for longer than the guard time defined in 3GPP TS 24.008. If the BSS recognises that a call has terminated then a CLEAR REQUEST message should be generated.

If a 2Mbit/s system fails and one of the standard alarms is received, no action is taken at the BSS on the calls associated with the traffic channels involved.

At the MSC, calls or VGCS talker dedicated connection and associated uplink or resource controlling connection should be cleared if either subscriber clears, or if the BSS sends a CLEAR REQUEST message. Clearing of affected calls by the MSC may take place after loss of the traffic channels for a period defined by the operator.

For the procedures controlled by the MSC, and in particular procedures where the MSC sends a request for resources at the BSS and waits for an acknowledge, the implementation in the MSC must provide means for avoiding deadlock situations at the BSS as e.g. hanging resources.

### 3.1.16 Initial MS message

When the SCCP connection establishment is performed by the BSS, the radio interface initial L3 message received from the MS (piggybacked on the SABM frame) is processed as follows:

The BSS shall analyse the protocol discriminator of the message.

If the BSS does not support the protocol, reactions of the BSS are specified in 3GPP TS 44.018. If the BSS supports the protocol, it shall analyse the message to a level which allows the extraction by the BSS of the Classmark information and, if the network supports "Intra domain connection of RAN nodes to multiple CN nodes", the Mobile Identity (see 3GPP TS 23.236 [48]). However, except for the NOTIFICATION RESPONSE, the entire radio interface initial L3 message (e.g. CM SERVICE REQUEST, PAGING RESPONSE, CM REESTABLISHMENT REQUEST, LOCATION UPDATING REQUEST, IMSI DETACH, IMMEDIATE SETUP) is also passed to the MSC, using a COMPLETE LAYER 3 INFORMATION message. The BSS does not analyse the contents of the initial layer 3 message, other than the Classmark information and, if the network supports "Intra domain connection of RAN nodes to multiple CN nodes", the Mobile Identity. If an IP based user plane interface is supported, the COMPLETE LAYER 3 INFORMATION message shall include the Information Element "Codec List (BSS Supported)".

If an IP based user plane interface is supported, the BSS shall predict to its best possible knowledge, which Codec Types, Codec Configurations, A-Interface Types and transcoder resources in the BSS could be used at this point in time. The BSS shall only include elements within the Codec List (BSS Supported) that are currently available.

The BSS may also give the MSC a description of the channel on which the initial layer 3 message was received.

Specific handling of LOCATION UPDATING REQUEST initial Layer 3 message, related to MOCN configuration of network sharing, is described in § 3.1.32.

### 3.1.17 Queuing Indication

The purpose of the QUEUING INDICATION message is to inform the MSC about a delay in the allocation of the necessary dedicated radio resources. The procedure is only relevant if the system is using a queuing procedure for traffic channels in the BSS, (sub-clause 3.1.17.1) and/or for handover of traffic channels (sub-clause 3.1.17.2).

#### 3.1.17.1 Operation of the procedure in case of assignment procedure

After the ASSIGNMENT REQUEST message without having the necessary TCH available the ASSIGNMENT REQUEST message shall be put into a queue; the QUEUING INDICATION message shall be returned to the MSC and the timer T11 shall be started. The timer value T11 specifies the maximum queuing delay and is determined by the operator.

The procedure shall be terminated with a successful or unsuccessful assignment of the required traffic channel(s) by sending an ASSIGNMENT COMPLETE or an ASSIGNMENT FAILURE message, respectively, to the MSC.

If the timer T11 expires the ASSIGNMENT REQUEST message shall be removed from the queue and a CLEAR REQUEST message shall be sent to the MSC, with the Cause "no radio resource available".

#### 3.1.17.2 Operation of the procedure in case of hand-over resource allocation procedure

After the HANDOVER REQUEST message without having the necessary TCH available the HANDOVER REQUEST shall be put into a queue; the QUEUING INDICATION message shall be returned to the MSC and the timer Tqho shall be started. The timer value Tqho specifies the maximum queuing delay and is determined by the operator.

The procedure shall be terminated with a successful or unsuccessful reservation of the required traffic channel(s) by sending a HANDOVER REQUEST ACKNOWLEDGE or a HANDOVER FAILURE message, respectively, to the MSC.

If the timer Tqho expires the HANDOVER REQUEST shall be removed from the queue and a HANDOVER FAILURE message shall be sent to the MSC with the Cause value "no radio resource available".

### 3.1.18 Data Link Control SAPI not Equal to "0"

The radio interface can support data links with the SAPI not equal to "0".

#### 3.1.18.1 Data link set up across the radio interface

This sub-clause deals with the impact of data link establishment (SAPI not equal to "0") on the MSC to BSS interface.

##### 3.1.18.1.1 MS to MSC direction

In the MS to MSC direction the receipt of a layer 3 message via a data link where SAPI does not equal "0" at the BSS will be transferred to the MSC as a DTAP message with the DLCI (Data Link Connection Identification) octet set appropriately.

##### 3.1.18.1.2 MSC to MS Direction

Receipt of a layer 3 (DTAP) message from the MSC with the SAPI (indicated in the DLCI) not equal to "0" will cause one of the following actions:

- the triggering of a data link set up to support the message transfer across the radio interface if no suitable link exists;
- the transmission of the message to the MS if a suitable link has already been established;
- the sending of a BSSMAP SAPI "N" REJECT message to the MSC if for any reason the data link cannot be established, A Cause Information Element is included; typical Cause values are: "O&M intervention", "processor overload", "BSS not equipped", "MS not equipped".

#### 3.1.18.2 Choice of the signalling link

When the BSS relays a message of the PDSS1 protocol received on the air interface to the MSC, it shall indicate in the DLCI (see 3GPP TS 48.002) on which control channel and SAPI the message was received.

When the MSC sends a DTAP message to the BSS, it shall:

- if the protocol of the corresponding air interface layer 3 message is PDSS1, specify on which control channel and SAPI of the air interface the L3 message shall be sent;
- otherwise not further specify the control channel on the air interface.

When the BSS relays an air interface L3 message received in a DTAP message on the A interface to the MS, it shall:

- if the DLCI does not further specify the signalling channel of the air interface, send it on the appropriate signalling link;
- if the BSS supports PDSS1 and the DLCI specifies which control channel is to be used for transmission on the air interface, the BSS shall transfer the air interface L3 message on the specified control channel.

NOTE: If the BSS does not support PDSS1, it considers the part of the DLCI possibly indicating the control channel to be used on the air interface as spare bits, see 3GPP TS 48.002.

### 3.1.19 BSSMAP Error Handling

To allow for the introduction of new functions the following rules shall be used to determine the actions of a receiving entity when it receives a message, part or all of which it is unable to understand. As the recipient is unable to tell the difference between a new, previously unspecified coding and an erroneous coding, the recipient also uses the same rules for error handling.

The robustness of a recipient in handling erroneous messages does not relax the requirement that the transmitter shall obey the present document. However, it is intended that functionality can be gradually added to an entity, and no obstacle to intermediate phase equipment is intended.

With the exception of sub-clause 3.1.19.6, the specific 'abnormal case' handling in other sub-clauses of the present document take precedence over this sub-clause.

### 3.1.19.1 Definitions of Types of Information Elements

The following definitions shall be used in sub-clause 3.1.19 and only in this sub-clause.

#### Essential Elements

These are the conditional elements when the condition for their reception is fulfilled, plus the Mandatory elements excluding the Cause value information element (sub-clause 3.2.2.5).

#### Mandatory Elements

These are the Information Elements marked as 'M' in sub-clause 3.2.1.

#### Non-Essential Elements

Non-essential elements are all the information elements that are not defined as essential.

#### Conditional Elements

In the indicated messages the following elements are conditional:

- Circuit identity code in sub-clauses 3.2.1.1 and 3.2.1.8.
- Circuit pool list in sub-clauses 3.2.1.3, 3.2.1.9, 3.2.1.16 and 3.2.1.55.

NOTE: A conditional IE is an IE whose presence or absence in a message can be determined by information contained in the rest of the message.

#### Transparent Elements

The following elements are defined as transparent:

- for the BSS: TMSI;
  - RR cause;
  - Layer 3 information in the BSSMAP HANDOVER COMMAND message; and
  - Layer 3 message contents; and for the MSC: Resource situation.
  - Layer 3 information in the BSSMAP HANDOVER REQUEST ACKNOWLEDGE message; and
- "Old BSS to new BSS information" in the BSSMAP HANDOVER REQUIRED message;
- "Source RNC to target RNC transparent information (UMTS)" in the BSSMAP HANDOVER REQUIRED message;
- "Source RNC to target RNC transparent information (cdma2000)" in the BSSMAP HANDOVER REQUIRED message.

#### Non-Transparent Elements

Non-transparent elements are all the information elements that are not defined as transparent.

### 3.1.19.2 Erroneous Events

The following events shall be regarded as errors by the recipient:

- a message whose type is non-existent, unrecognisable, not consistent with the recipient's state, or, that is sent in the wrong direction. This includes messages that should use the SCCP connectionless service but that are received on an SCCP connection, and vice versa;
- a missing essential information element;
- use of a reserved codepoint in an information element that is both essential and non-transparent; and

- an essential and non-transparent information element which is too short (the contents of any 'Length' octet shall be used to determine the boundary of the element).

When a recipient detects one or more of these events it shall return the appropriate error message with a suitable Cause value and the message shall be discarded.

### 3.1.19.3 Non-erroneous Events

The following events shall not be regarded as errors by the recipient:

- spare bits with an unexpected value in any information element;
- the use of additional octets in any information element with a length octet;
- a missing non-essential information element;
- use of reserved codepoints in any non-essential information element or in any transparent information element; and
- a non-essential information element or a transparent information element whose length is too short.

When the recipient detects one or more of these events the receiving entity shall ignore the information that it is unable to understand and treat the message on the basis of the information that remains.

Additionally:

- all information in a message that is received after the start of an information element with an unrecognisable identifier shall be ignored. The message shall be accepted or rejected solely on the basis of the information received before the start of the unrecognisable element; and
- when more information elements of a particular type are received than are expected, the last one(s) shall be ignored.

### 3.1.19.4 Other Events

The following events should be treated on a case by case basis and the outcome may depend upon the capabilities of the recipient.

- 1 The recipient may accept messages that contain information elements that do not appear to be in the correct sequence. Elements that occur more than once in a message shall be assumed to have been transmitted in the correct order. Recipients that do not accept out of sequence information elements shall regard the message as containing unexpected and/or missing information elements and follow the procedures of sub-clauses 3.1.19.1 and/or 3.1.19.2.
- 2 Where a field in an information element contains a value, which the recipient knows to be incorrect, the recipient shall either reject the message or it shall ignore that field, and treat the information that remains in the message.

(e.g. if the 'Number of MSs' in a Handover Candidate Response message is greater than the number of Handover Required messages received).

### 3.1.19.5 Appropriate Error Message and Cause Value

The choice of error message depends upon the received message type:

Received message type	Error Message
ASSIGNMENT REQUEST HANDOVER REQUEST HANDOVER REQUIRED: - if "Response Request" i.e. is present - if "Response Request" i.e. is not present CIPHER MODE COMMAND VGCS/VBS SETUP VGCS/VBS ASSIGNMENT REQUEST CONFUSION all other message types	ASSIGNMENT FAILURE HANDOVER FAILURE  HANDOVER REQUIRED REJECT CONFUSION CIPHER MODE REJECT VGCS/VBS SETUP REFUSE VGCS/VBS ASSIGNMENT FAILURE an error message shall not be used CONFUSION

When a problem is experienced with a message sent over an SCCP connection, the error message is returned over that connection. When a problem occurs in a message sent using the SCCP connectionless service, the error message is returned using the SCCP connectionless service.

To avoid overload of the A-interface, transmission of error messages may be inhibited. (However, the transmission of Assignment Failure, Handover Failure, Handover Required Reject and Cipher Mode Reject messages in the cases required by sub-clauses 3.1.1, 3.1.5, 3.1.5a and 3.1.14 shall not be inhibited.) When the transmission of error messages is inhibited, they shall be replaced by some kind of notification to O&M. Several settings may be used to allow various subsets of 'error events' to trigger error messages while the remaining events only lead to O&M notification.

The Error pointer in the Diagnostics information element should be used to indicate the position of a detected error in the received message. Typical Causes are:

Cause	Usage
Invalid cell	Indicated cell not controlled by the BSS or not reachable through the MSC. May also be used for handover outside group call area.
Invalid message contents	May be used in any error message.
Protocol error between BSS and MSC	The received message is not consistent with the receiver's state, or the message has been sent in the wrong direction, or the message uses the wrong SCCP service (connection oriented instead of connectionless or vice versa).
Information element or field missing	Data missing from the area indicated by the error pointer.
Incorrect value	A field (that should be indicated by the error pointer) contains an incorrect or incompatible value, or uses a reserved codepoint.
Unknown message type	The received message was of an unknown type.
Unknown information element	An information element identifier (that should be indicated by the error pointer) contains an unknown value.

### 3.1.19.6 Unequipped Circuit Identification Code

If a MSC or BSS receives a message indicating one or more circuit which are unknown the following actions shall be taken:

- If an ASSIGNMENT REQUEST, a VGCS/VBS ASSIGNMENT REQUEST or a HANDOVER REQUEST message is received containing a circuit identity code which is unknown to the BSS the appropriate failure message is returned to the MSC. In addition the UNEQUIPPED CIRCUIT message is sent to the MSC for the circuit concerned.
- If an ASSIGNMENT COMPLETE, a VGCS/VBS ASSIGNMENT RESULT, a HANDOVER REQUEST ACKNOWLEDGE or a CHANGE CIRCUIT ACKNOWLEDGE Message is received containing a circuit identity code which is unknown to the MSC, it is up to the MSC to correct the situation, e.g. by performing a circuit re-selection procedure and sending an UNEQUIPPED CIRCUIT Message to the BSS.
- If a circuit supervision message (BLOCK, UNBLOCK or RESET CIRCUIT) is received containing a circuit identity code which is not known no respective acknowledgement is returned. Instead an UNEQUIPPED CIRCUIT Message is sent to the peer entity for the circuit concerned.
- If a circuit supervision acknowledgement message (BLOCKING ACKNOWLEDGE, UNBLOCKING ACKNOWLEDGE or RESET CIRCUIT ACKNOWLEDGE) is received containing a circuit identity code which is not known, an UNEQUIPPED CIRCUIT message is sent to the peer entity for the circuit concerned.

- If a circuit group supervision message (GROUP BLOCK, GROUP UNBLOCK) is received which affects one or more circuits which are unknown to the own entity the returned acknowledgement message shall not contain any information about these circuit(s), i.e. the respective status bit(s) in the status field shall not be set. Instead an UNEQUIPPED CIRCUIT Message is sent to the peer entity for the circuit(s) concerned.
- If a circuit group supervision acknowledgement message (CIRCUIT GROUP BLOCKING ACKNOWLEDGE or CIRCUIT GROUP UNBLOCKING ACKNOWLEDGE) is received which affects one or more circuits which are unknown to the own entity an UNEQUIPPED CIRCUIT message is sent to the peer entity for the circuit(s) concerned.
- If an UNEQUIPPED CIRCUIT Message is received indicating a circuit which is unknown in the own entity no UNEQUIPPED CIRCUIT Message will be returned.

If an UNEQUIPPED CIRCUIT Message is received indicating a circuit(s) that is known to the recipient, the indicated circuit(s) should be removed from service and the situation should be reported to the maintenance system for further intervention. The UNEQUIPPED CIRCUIT message is not to be acknowledged by the recipient.

### 3.1.19.7 Field Elements

This sub-clause defines the generic error handling to be applied to the field elements found in the *Old BSS to New BSS Information*, *New BSS to Old BSS Information* and *Inter-System Information* information elements.

All field elements shall be treated as non-essential.

The following events shall not be regarded as errors by the recipient:

- spare bits with an unexpected value in any field element;
- the use of additional octets in any field element;
- a missing field element;
- a field element whose length is either too short or too long.

When the recipient detects one or more of these events the receiving entity shall ignore the information that it is unable to understand and treat the message on the basis of the information that remains:

- when an unknown field element identifier is encountered, the unknown field element shall be skipped and the receiver shall continue processing any remaining field elements;
- when more field elements of a particular type are received than are expected, the last one(s) shall be ignored;
- when a sub-field in a field element contains a value, which the recipient knows to be incorrect, the recipient shall either ignore that sub-field or ignore the entire field (treating it as if the field element had not been received); and
- when a sub-field in a field element contains a reserved value, the recipient shall ignore the entire field element (treating it as if the field element had not been received).

### 3.1.20 Load Indication Procedure

The purpose of the load indication procedure is to inform all neighbour BSS's about the traffic situation of a cell.

The philosophy is to control the incoming handover traffic at the source, i.e. the BSS of the concerned cell informs all of its neighbour BSS's about the load situation. This is achieved by sending a LOAD INDICATION message to the neighbour BSS's. On receipt of the LOAD INDICATION message the BSS may analyse the load information and take the traffic load into consideration when deciding a handover.

The algorithm in which the BSS decides on starting a Load Indication procedure is operator dependent.

The implementation of the Load Indication procedure shall be regarded as optional, that means, if this procedure is not used, the Load Indication message may be ignored by these network elements.

### 3.1.20.1 Operation of the procedure

The procedure operates as follows:

The BSS shall send the LOAD INDICATION message to the MSC with the following information:

- Cell Identifier of the cell where the traffic load situation takes place (Cell Identifier information element).
- The Time indication information element contains the time where the traffic load information shall be valid on the receiving side.
- The Cell identifier list information element contains the cell identifier of the affected neighbour cells.
- The information about the total number of channels accessible or in use, and the information about the current number of channels available for each reported channel type on the indicated cell (Resource situation information element).
- The reason for sending this message (Cause information element).

On receipt of the LOAD INDICATION message, the MSC transmits this message to all BSS's as derived from the Cell identifier list Information Element.

NOTE: In the case where more than one indicated cells in the cell identifier list IE belong to the same BSS, the MSC should try to send the LOAD INDICATION message only once to this BSS.

With each reception of a LOAD INDICATION message from the MSC the target BSS shall analyse the resource information and adapt the handover traffic either from all cells of the BSS-area or only from the cells contained in the Cell identifier list Information Element to the cell indicated in the Cell identifier Information Element. The BSS shall ignore all Cell identifiers for cells which do not belong to its area.

In the case where the BSS receives a LOAD INDICATION message without the Resource situation information element, that means the indicated cell is not able to perform incoming handover requests and the receiving BSS may stop the whole handover traffic to this cell.

The traffic load information shall only be valid the time as indicated in the Time indication Information Element. The control timer shall be stopped with the receipt of a new LOAD INDICATION message and restarted with the new value. If the Time field contains the value 0, the load information is no longer valid.

### 3.1.21 Voice group call service and voice broadcast service call set-up and resource assignment

To set-up a VGCS/VBS call the MSC initiates the VGCS/VBS set-up procedure to the BSS. The MSC can then allocate resources to the VGCS/VBS call by initiating the VGCS/VBS Assignment procedure. If a priority IE is included in the VGS/VBS ASSIGNMENT REQUEST message then the priority level in this Priority IE takes precedence over any priority level that may have been included in the VGCS/VBS SETUP message.

The BSS and MSC may indicate the support of some optional features through the VGCS/VBS SETUP and VGCS/VBS SETUP ACK messages. To support an optional feature both the VGCS/VBS SETUP and VGCS/VBS SETUP ACK messages must indicate that the feature is supported. The BSS shall only indicate the support of a given optional feature in the VGCS/VBS SETUP ACK message if the MSC had indicated its support of this feature in the VGCS/VBS SETUP message. Support of the following features may be indicated through these messages:

- A-interface circuit sharing;
- A-interface link sharing;
- Talker priority;
- Group call re-establishment by the BSS;
- Talker channel parameter.



### 3.1.21.1 Successful operation

To initiate a VGCS/VBS call set-up procedures the MSC sends to the BSS a VGCS/VBS SETUP message across VGCS/VBS call controlling SCCP connection. This connection is established for the life time of the VGCS/VBS call.

The BSS allocates resources to the call and returns VGCS/VBS SETUP ACK message to the MSC.

When the MSC supports talker priority it shall indicate its support in each VGCS/VBS SETUP message. If the VGCS/VBS SETUP message indicates support of talker priority and the BSS supports talker priority, then the VGCS/VBS SETUP ACK message shall indicate support of talker priority. The network supports talker priority if both the MSC and BSS indicate their support in the VGCS/VBS SETUP and VGCS/VBS SETUP ACK messages, respectively.

If the BSS supports one of the requested types of A-interface resource sharing (that are indicated by the MSC in the VGCS/VBS SETUP message) it includes the supported type (i.e. either A-interface circuit sharing or A-interface link sharing) in the VGCS/VBS SETUP ACK.

An MSC or BSS supporting A-interface link sharing shall also support the procedures for group call re-establishment by the BSS. The network supports Group call re-establishment by the BSS if both the MSC and BSS indicate their support of this feature in the VGCS/VBS SETUP and VGCS/VBS SETUP ACK messages respectively, or if both the MSC and BSS indicate that they support A-interface link sharing in the VGCS/VBS SETUP or VGCS/VBS SETUP ACK messages, respectively. An MSC or BSS shall explicitly indicate support of the feature "group call re-establishment by the BSS" in the VGCS Feature Flags IE only, if the feature is supported in a configuration without A-interface link sharing.

When the MSC supports talker channel parameter and requires a dedicated channel to be established for any talker in the cell for a specific group call it shall explicitly indicate its configuration in each VGCS/VBS SETUP message. If the VGCS/VBS SETUP message indicates configuration of talker channel parameter and the BSS supports talker channel parameter, then the VGCS/VBS SETUP ACK message shall indicate its support and the BSS shall establish and maintain a dedicated traffic channel for any talker in that group call in the cell.

### 3.1.21.2 VGCS/VBS call set-up abnormal cases

If the BSS detects that the VGCS/VBS call is already set-up it will clear all resources associated with the previous call and proceed with the new call.

If the VGCS Feature Flags IE in the VGCS/VBS SETUP ACK message indicates the support of an optional feature that was not indicated as supported in the VGCS Feature Flags IE in the VGCS/VBS SETUP message, then the MSC shall send a CLEAR COMMAND via the VGCS/VBS call controlling SCCP connection to the BSS and release the call control SCCP connection.

### 3.1.21.3 VGCS/VBS call set-up failure

If the BSS can not set-up the VGCS/VBS call then it will send a VGCS/VBS SETUP REFUSE message to the MSC.

## 3.1.22 Voice group call service and voice broadcast service Assignment procedure

The purpose of the VGCS/VBS Assignment procedure is to ensure that the correct dedicated radio resources are allocated to the VGCS/VBS call on a per cell basis. In case of A-interface link sharing the procedure has to ensure that the correct dedicated resources are allocated to the VGCS/VBS call on a per BSS basis. In order to support this procedure the MSC sets up a VGCS/VBS resource controlling SCCP connection to the BSS. This connection is then used to support all BSSAP messages related to the dedicated resource(s).

The MSC can command that the radio resources are either allocated immediately or delayed.

### 3.1.22.1 Successful operation

The VGCS/VBS call controlling SCCP connection shall be established before the VGCS/VBS Assignment procedure takes place.

The MSC initiates the VGCS/VBS Assignment procedure to the BSS by sending a VGCS/VBS ASSIGNMENT REQUEST on a VGCS/VBS resource controlling SCCP connection. In the case of a ciphered group call the MSC shall provide the BSS with the VSTK and VSTK\_RANDOM. These parameters are used to derive the voice group or broadcast group ciphering key as described in 3GPP TS 43.020.

If the MSC and BSS have indicated the support of a A-interface circuit sharing in the VGCS/VBS SETUP and VGCS/VBS SETUP ACK messages respectively, the MSC shall include the same CIC, Channel type and Downlink DTX flag in all of the VGCS/VBS ASSIGNMENT REQUEST messages that are sent to the BSS for a given group call.

The management of priority levels is implementation dependent and under operator control. Priority rules to handle VBS and VGCS calls are defined in TS 23.067 and 24.067.

If queuing applies and neither A-interface link sharing nor group call re-establishment are being used, new requests which cannot be assigned immediately are put in the queue according to the indicated priority levels (see sub-clause 3.1.22.4).

The priority levels and the preemption indicators may (singularly or in combination) be used to determine whether the assignment has to be performed unconditionally and immediately. This may lead to triggering of the preemption procedure which may then cause the forced release or forced handover of a lower priority connection if no free resource is immediately available.

The process and the extent of the preemption procedure is operator dependent, however, the preemption indicators (refer to sub-clause 3.2.2.18.), if given in the VGCS/VBS ASSIGNMENT REQUEST shall be treated on a per connection basis as follows:

- if the "Preemption Capability indicator" bit is set to 1, then this allocation request can trigger the running of the preemption procedure.
- if the "Preemption Capability indicator" bit is set to 0, then this allocation request cannot trigger the preemption procedure.
- if the "Preemption Vulnerability" bit is set to 1, then this connection is vulnerable and shall be included in the preemption process or procedure and as such may be subject to forced release or forced handover of a talker in group transmit mode.
- if the "Preemption Vulnerability" bit is set to 0, then this connection is not vulnerable to preemption and shall not be included in the preemption process and as such may not be subject to forced release or forced handover of a talker in group transmit mode.
- if no Priority Information Element has been received, both "Preemption Capability" and "Preemption Vulnerability" bits shall be regarded as set to 0.

The MSC shall control VGCS/VBS radio resource allocation on demand to be enabled or disabled by including "Assignment Requirement" IE in VGCS/VBS ASSIGNMENT REQUEST and optionally in VGCS/VBS AREA CELL INFO. The MSC uses the "Assignment Requirement" IE to control whether the BSS is allowed to de-allocate the VGCS/VBS radio resources before the end of the call. If the *Assignment Requirement* IE is not included in the VGCS/VBS AREA CELL INFO message, the method of radio resource allocation for the cells in the *Cell Identifier List Segment* IE shall be the same as the one last indicated in VGCS/VBS ASSIGNMENT REQUEST or VGCS/VBS AREA CELL INFO.

When the MSC and BSS have indicated the support of a A-interface circuit sharing, the BSS shall select one channel rate and one speech version for use in all cells for the group call that are using the same shared circuit, based on the first accepted VGCS/VBS ASSIGNMENT REQUEST message that is using this circuit.

The BSS will return VGCS/VBS ASSIGNMENT RESULT to the MSC to inform the MSC of the resources allocated by the BSS for the concerned cell. The BSS shall include a Circuit Identity Code information element in the VGCS/VBS ASSIGNMENT RESULT message indicating the terrestrial circuit which is used for the VGCS/VBS call, if the BSS allocates the circuit. If the circuit was allocated by the MSC, the BSS may include the Circuit Identity Code information element (containing the same value as sent by the MSC) in the VGCS/VBS ASSIGNMENT RESULT message.

If the MSC and BSS have indicated the support of a A-interface circuit sharing, the BSS shall return a VGCS/VBS ASSIGNMENT RESULT message for each received VGCS/VBS ASSIGNMENT REQUEST message that indicates the use of the same CIC, Channel Type and Downlink DTX flag. The SCCP connections shall be handled in the same manner irrespective of whether A-interface circuit sharing is used.

In case of A-interface link sharing a list of the cells belonging to the group call area is included in the VGCS/VBS ASSIGNMENT REQUEST. If the list does not completely fit into the VGCS/VBS ASSIGNMENT REQUEST message or if different methods of radio resource allocation are to be used for different cells controlled by the BSS or the list is segmented because the cell identities could not be contained in one message for the chosen cell discriminator, the remaining part of the list is sent in VGCS/VBS AREA CELL INFO messages. The VGCS/VBS ASSIGNMENT REQUEST message is sent first followed by one or more VGCS/VBS AREA CELL INFO messages until the complete list of cells has been transferred to the BSS. The Cell Identifier IE of the VGCS/VBS ASSIGNMENT REQUEST message shall indicate the cell of origin, if controlled by that BSS. In the other case no further information shall be included in this IE. The Cell identification discriminator shall be set to indicate that no cell is associated with the transaction. See subclause 3.2.2.17. The *Cell Identifier List Segment* IE shall be included in the VGCS/VBS ASSIGNMENT REQUEST message if one or more cells have to be identified by this IE or one or more VGCS/VBS AREA CELL INFO messages is to follow. The BSS is responsible for the establishment and re-establishment of the radio resources for the different cells.

In case of A-interface link sharing, if the originating cell is served by the BSS, the VGCS/VBS ASSIGNMENT RESULT message shall be returned once the resource for this cell is established.

In the case of A-interface link sharing, if the originating cell is not served by the BSS the, the BSS shall return the VGCS/VBS ASSIGNMENT RESULT message even if no resource can be established. If resources could not be established in any cell, the Channel field in the *Chosen Channel* IE shall be set to "none" and a VGCS/VBS ASSIGNMENT STATUS message shall be sent to the MSC as soon as the first cell is established.

Timer Tast is (re-)started after sending either a VGCS/VBS ASSIGNMENT RESULT or a VGCS/VBS ASSIGNMENT STATUS message to the MSC. The timer is stopped when the associated A-interface link is released. The A-interface link established by this procedure is not pre-emptable and will only be released if the call is released. This A-interface link is shared by the control and user plane of all group call channels involved in the VGCS/VBS call at the given BSS.

In case of A-interface link sharing and when the network supports uplink access option (i) as defined in 3GPP TS 43.068 (i.e. an indication in the uplink busy instructs the MS to use the group call channel to send the uplink access message if the talker on the group call channel is not in the same cell as the MS) the BSS and MSC shall include talker priority information in A-interface messages on the resource controlling SCCP connection as specified in subclause 3.2.1. The Talker Priority information may be used to distinguish between messages related to the current talker and messages related to another subscriber requesting the uplink.

The BSS shall initiate the radio interface notification procedure on the NCH of the cell in which the call is to take place, this may continue at regular intervals until the call is released or the cell has been reported as released for the voice group or broadcast call. The BSS may on SACCH indicate that a change of notification has occurred and/or initiate notification on FACCH.

In the case where the BSS deallocates/allocates resources to the cell and neither A-interface link sharing or group call re-establishment by the network are supported, the BSS sends an VGCS/VBS ASSIGNMENT RESULT message on the VGCS/VBS resource controlling SCCP connection associated to the cell.

In the case where the BSS deallocates resources to the cell and group call re-establishment by the BSS is supported by the network and A-interface link sharing is not being used, then the BSS sends an VGCS/VBS ASSIGNMENT STATUS message on the VGCS/VBS resource controlling SCCP connection associated to the cell indicating the reason for the release.

In case of A-interface link sharing the BSS waits for timer Tast to expire before it sends to the MSC a report of the cells whose status has changed since the most recently sent VGCS/VBS ASSIGNMENT STATUS message (or group of VGCS/VBS ASSIGNMENT STATUS messages) or VGCS/VBS ASSIGNMENT RESULT message was generated. This report is sent using one or, if needed, more VGCS/VBS ASSIGNMENT STATUS messages. If no change occurred the message shall not be sent. Timer Tast shall be re-started each time it expires. A report (comprising one or, if needed, more VGCS/VBS ASSIGNMENT STATUS messages) shall be sent immediately and timer Tast shall be re-started when the group call is established in all cells served by this A-Interface link for the first time.

The VGCS/VBS ASSIGNMENT STATUS message shall indicate to the MSC cells where

- the call is established; or
- the BSS will attempt to establish the call; or
- the call is released because there is no user present in that cell; or

- the BSS will not attempt to establish the call.

NOTE: These lists may not be applicable in all cases. The usage of the lists varies according to the features supported by the network.

A cell shall appear in at most one list within a given VGCS/VBS ASSIGNMENT STATUS message and shall appear at most once within a report comprising a group of VGCS/VBS ASSIGNMENT STATUS messages.

In the case of voice group calls, if the MSC has informed the BSS to which voice group call the originator MS belongs to, the BSS may decide to modify the originator dedicated channel into a voice group call channel relating to the group call reference. If the BSS modifies the channel it will send the VGCS/VBS ASSIGNMENT RESULT message on the resource controlling SCCP connection and then immediately afterwards send a CLEAR REQUEST cause "Joined group call channel" on the originator dedicated connection.

### 3.1.22.2 VGCS/VBS Assignment abnormal cases

In the abnormal case, where a BSS detects that a voice broadcast or voice group call already exists with the same group call reference in a cell (this may occur due to SCCP problems), the BSS shall release the radio resources associated with the cell for the present existing voice broadcast or voice group call and shall allocate resources to the new call.

If the requested channel type indicated in the VGCS/VBS ASSIGNMENT REQUEST message is not available in the BSS, then an VGCS/VBS ASSIGNMENT FAILURE message shall be returned to the MSC. The appropriate failure cause will be included in the message (Cause value: "requested transcoding/rate adaptation unavailable" or "requested speech version unavailable").

If the BSS receives a VGCS/VBS ASSIGNMENT REQUEST message calling up a terrestrial circuit that is already assigned to another call then a VGCS/VBS ASSIGNMENT FAILURE message will be returned with a Cause value of: "terrestrial circuit already allocated" and no action will be taken on the radio interface.

If the BSS receives a VGCS/VBS ASSIGNMENT REQUEST message allocating a terrestrial circuit which has been blocked by a previous blocking procedure, then an VGCS/VBS ASSIGNMENT FAILURE message shall be sent (Cause value: "requested terrestrial resource unavailable"). A BLOCK message (not repeated and not guarded by timer T1) shall be sent for that concerned terrestrial circuit.

If the BSS receives a VGCS/VBS ASSIGNMENT REQUEST message that contains an Encryption Information IE that indicates that the radio resource is to be ciphered, but the message does not contain both the VSTK\_RAND and VSTK information elements, then a VGCS/VBS ASSIGNMENT FAILURE message shall be sent (Cause value of: "invalid message contents").

When the voice group call has been configured to use A-interface circuit sharing and either the VGCS/VBS ASSIGNMENT REQUEST message does not contain a CIC, or the VGCS/VBS ASSIGNMENT REQUEST messages contains a different CIC, Channel Type or Downlink DTX flag from that sent in a previous VGCS/VBS ASSIGNMENT REQUEST message for a given group call within a given BSS, then the BSS shall reply with VGCS ASSIGNMENT FAILURE message (Cause value: "invalid message contents"). Also, if the cell identified in the VGCS/VBS ASSIGNMENT message does not support the selected channel rate and speech version, then the BSS shall reply with VGCS ASSIGNMENT FAILURE message (Cause value: "requested transcoding/rate adaptation unavailable" or "requested speech version unavailable").

If the BSS receives, in the case of A-interface link sharing, more than one VGCS/VBS ASSIGNMENT REQUEST message with the same group call reference, the BSS shall release the radio resources and terrestrial resources associated with the present existing voice broadcast or voice group call and shall allocate resources to the new call and the BSS shall stop timer T<sub>ast</sub>. (The timer will be started again after the VGCS/VBS ASSIGNMENT RESULT message is sent.)

If, in the case of A-interface link sharing, the BSS receives in the Cell Identifier List Segment IEs (contained within VGCS/VBS ASSIGNMENT REQUEST or VGCS/VBS AREA CELL INFO messages) multiple references to the same cell (either within a single IE or within multiple IEs), the BSS shall send either a CLEAR REQUEST (if a VGCS/VBS ASSIGNMENT RESULT message has already been sent) or a VGCS/VBS ASSIGNMENT FAILURE message (if no VGCS/VBS ASSIGNMENT RESULT message has been sent) with cause value "Invalid Message Contents" to the MSC.

If, in the case of A-interface link sharing, the BSS receives a VGCS/VBS AREA CELL INFO message with a sequence number higher than the sequence length (as indicated in the VGCS/VBS ASSIGNMENT REQUEST message), the BSS shall send either a CLEAR REQUEST (if a VGCS/VBS ASSIGNMENT RESULT message has already been sent) or a

VGCS/VBS ASSIGNMENT FAILURE message (if no VGCS/VBS ASSIGNMENT RESULT message has been sent) with cause value "Invalid Message Contents" to the MSC.

### 3.1.22.3 VGCS/VBS Assignment failure

In the case where the VGCS/VBS call is unknown by the BSS, the BSS shall return the VGCS/VBS ASSIGNMENT FAILURE message (cause "VGCS/VBS call non existent").

In the case where no radio resource can be allocated to the VGCS/VBS call, the BSS shall return the VGCS/VBS ASSIGNMENT FAILURE message (cause "No radio resource available").

In case of A-interface link sharing, the BSS shall return the VGCS/VBS ASSIGNMENT FAILURE message (cause "No radio resource available") if the originating service subscriber is served by the BSS and resources for the cell of origin cannot be allocated.

In the case where no radio resource can be allocated to the VGCS/VBS call for channel establishment on demand and A-interface link sharing is not being used, the BSS shall return the CLEAR REQUEST message (cause "No radio resource available").

NOTE: In the case of A-interface link sharing, the BSS is responsible for the re-establishment and does not send the CLEAR REQUEST message.

In the case where the MSC has attempted to assign a terrestrial circuit and an VGCS/VBS ASSIGNMENT FAILURE message has been returned then both the MSC and the BSS shall consider that the terrestrial circuit is idle (except already allocated to another call or to another connection in the same VGCS/VBS call if A-interface circuit sharing has been configured or blocked terrestrial circuit) and therefore no explicit clearing sequence is needed.

If the BSS is unable to allocate any resources for a cell not serving the originating subscriber when it receives a VGCS/VBS ASSIGNMENT REQUEST message and group call re-establishment by the BSS is supported by the network but A-interface link sharing is not being used, then the BSS shall send a VGCS/VBS ASSIGNMENT RESULT message with a *Chosen Channel* IE in which the channel field is set to "none". Additionally the BSS shall send a VGCS/VBS ASSIGNMENT STATUS message to the MSC.

NOTE: In case of A-interface link sharing the procedure in case the call cannot be established in any cell and the cell serving the originating subscriber is not parented by the BSS is described in sub-clause 3.1.22.1.

In the case that group call re-establishment by the BSS is supported by the network but A-interface link sharing is not being used and the BSS receives a VGCS/VBS ASSIGNMENT REQUEST message for the cell serving the originating subscriber that requires resources that use failed equipment or resources that cannot be allocated because of congestion, then the BSS shall send to the MSC a VGCS/VBS ASSIGNMENT FAILURE message.

### 3.1.22.4 VGCS/VBS Queuing Indication

This subclause is not applicable if A-Interface link sharing or group call re-establishment by BSS is used.

In a BSS supporting the VGCS/VBS message queuing, the purpose of the VGCS/VBS QUEUING INDICATION message is to inform the MSC about a delay in the allocation of the necessary dedicated radio resources.

When a VGCS/VBS ASSIGNMENT REQUEST message is received which cannot be served immediately due to lack of available resources and if the "Queuing Allowed" bit in the Priority Information Element indicates that queuing is allowed, then the request shall be put into a queue and timer T14 shall be started. The timer value T14 specifies the maximum queuing delay and is determined by the operator. The VGCS/VBS QUEUING INDICATION message shall be returned to the MSC.

The queuing procedure shall be terminated with a successful or unsuccessful assignment of the required traffic channel(s) by sending a VGCS/VBS ASSIGNMENT RESULT or a VGCS/VBS ASSIGNMENT FAILURE message, respectively, to the MSC.

If the timer T14 expires the VGCS/VBS ASSIGNMENT REQUEST message shall be removed from the queue and a VGCS/VBS ASSIGNMENT FAILURE message shall be sent to the MSC, with the Cause "no radio resource available" (refer to sub-clause 3.1.22.3).

If a resource in a queue could be successfully established, the timer T14 is stopped.

### 3.1.23 (void)

### 3.1.24 Voice group call uplink control procedure - talker priority not supported by the network

In the case of voice group calls the uplink resource allocated to the call is controlled by the uplink control procedure. The uplink control procedure uses messages sent on the VGCS/VBS controlling SCCP connection set-up by the VGCS/VBS call set-up procedure.

The procedure is split into three procedures: uplink allocation; uplink release; & uplink seize.

The uplink allocation is controlled by the BSSs and group call anchor MSC. The BSS controls the uplink access for the cells in the group call area which are under its control. The group call anchor MSC controls the uplink access for the complete service area. Any allocation of the uplink access by a BSS may be refused later by the group call anchor MSC (due to the allocation of the uplink by other BSSs involved in the same voice group call).

The uplink release & uplink seize procedure is controlled and initiated by the MSC, the BSS obeys the MSC's requests.

When the voice group call is initially set-up the state of the uplink in each BSS is such that the uplink is seized. The MSC will control the state of the uplink in each BSS by use of the uplink release and uplink seize procedures. Before an uplink may be allocated by the BSS, the MSC must have released the uplink by initiating the uplink release procedure.

#### 3.1.24.1 Uplink allocation procedure

The uplink allocation procedure allows a listening user in a voice group call to talk on the uplink of the TCH dedicated to the voice group call in the cell.

The uplink allocation procedure can only occur once the group call anchor MSC has released the uplink (by use of the uplink release procedure).

When a mobile relinquishes the uplink or the BSS detects that the MS is no longer connected, the BSS sends to the MSC an UPLINK RELEASE INDICATION message with cause value "Call control" or "Radio interface failure" respectively. Then the BSS shall initiate the radio interface uplink free procedure.

##### 3.1.24.1.1 Successful uplink allocation operation

On reception of a request to talk, the BSS sends an UPLINK REQUEST message to the MSC. The MSC sends the UPLINK REQUEST ACKNOWLEDGE message to confirm to the BSS that the uplink is granted to the requesting MS. The MSC also sends to all the other BSSs in the voice group call an UPLINK SEIZED COMMAND message.

The BSS sends UPLINK REQUEST CONFIRMATION message with the complete layer information, once the radio link has been established. The layer information may include the ciphering key sequence number.

##### 3.1.24.1.2 Unsuccessful uplink allocation operation

In the case that the radio link could not be established the BS sends the Uplink release indication with the cause "Radiolink interface message failure".

In the case the MSC does not want to grant the uplink, the MSC will send an UPLINK REJECT COMMAND message to the appropriate BSS. On reception of this the BSS will release the uplink for the requesting MS.

#### 3.1.24.2 Uplink release procedure

This procedure shall be used in one of the following cases:

- the group call anchor MSC detects that none of the parties involved in a voice group call are talking . The Uplink release procedure is then used to allow the listening subscribers to talk;
- the group call anchor or relay MSC detects that the talker has left the Group Call Area.

To initiate this procedure the group call anchor MSC sends the UPLINK RELEASE COMMAND message to each BSS involved in the voice group call. When the BSS receives the Uplink release request command, the BSS shall initiate the radio interface uplink release procedure.

### 3.1.24.3 Uplink seize procedure

This procedure shall be used by the MSC to inform a given BSS that the uplink has been successfully granted to a talking subscriber in another BSS area. To initiate the procedure the MSC sends UPLINK SEIZED COMMAND message to that given BSS. On reception of the UPLINK SEIZED COMMAND message the BSS will initiate the radio interface uplink busy procedure.

## 3.1.24a Voice group call uplink control procedure - talker priority supported by the network

### 3.1.24.a.1 General

Each network node that is involved in the group call shall maintain a record of the current call talker priority setting. The priority setting may be one of the following:

- normal subscriber request;
- privileged subscriber request;
- emergency subscriber request.

In the case of voice group calls the uplink resource allocated to the call is controlled by the uplink control procedure. The uplink control procedure uses messages sent on the VGCS/VBS controlling SCCP connection set-up by the VGCS/VBS call set-up procedure.

The procedure is split into five procedures: uplink allocation; uplink release; uplink seize, emergency reset and talker information.

The uplink allocation is controlled by the BSSs and group call anchor MSC. The BSS controls the uplink access for the cells in the group call area which are under its control. The group call anchor MSC controls the uplink access for the complete service area. Any allocation of the uplink by a BSS may be refused later by the group call anchor or relay MSC (due to the allocation of the uplink by other BSSs involved in the same voice group call or because the mobile station was not permitted to use the talker priority in the uplink request).

The uplink release, uplink seize and emergency reset procedure is controlled and initiated by the MSC. The BSS obeys the MSC's requests.

When the voice group call is initially set-up the state of the uplink in each BSS is such that the uplink is seized. The MSC will control the state of the uplink in each BSS by use of the uplink release and uplink seize procedures.

### 3.1.24a.2 Uplink allocation procedure

The uplink allocation procedure allows a listening user in a voice group call to talk on the uplink of the TCH dedicated to the voice group call in the cell.

The uplink allocation procedure can occur in the following situations:

- once the group call anchor MSC has released the uplink (by use of the uplink release procedure);
- or when there is a talker request with a higher priority than that of the current talker.

When a mobile relinquishes the uplink or the BSS detects that the MS is no longer connected, the BSS sends to the MSC an UPLINK RELEASE INDICATION message with cause value "Call control" or "Radio interface failure" respectively. Then the BSS shall initiate the radio interface uplink free procedure if there is no current talker.

### 3.1.24a.2.1 Successful uplink allocation operation

#### 3.1.24a.2.1.1 Normal Priority Request

Behaviour is as defined in sub-clause 3.1.24.1.

#### 3.1.24a.2.1.2 Privileged or Emergency Priority Request via Uplink Access procedure

On reception of a request to talk with privileged or emergency priority, the BSS sends an UPLINK REQUEST message to the MSC. The BSS sends UPLINK REQUEST message with the Layer 3 information once the link has been established on the radio interface. The Layer 3 information shall include the MS identity and may include the ciphering key sequence number.

The MSC sends the UPLINK REQUEST ACKNOWLEDGE message to confirm to the BSS that the uplink is granted to the requesting MS. This message shall contain the talker priority so that the BSS is able to determine which uplink request is being acknowledged. It shall also contain the status of the emergency mode. The BSS shall update the current talker priority when the priority in the UPLINK REQUEST ACKNOWLEDGE message is greater than the current talker priority, and releases the uplink for an MS being pre-empted if it is served by this BSS.

The MSC also sends to all the other BSSs in the voice group call an UPLINK SEIZED COMMAND message, containing the talker priority. Additionally, if the uplink priority was "Emergency", then the UPLINK SEIZED COMMAND message shall also contain the Emergency set indication IE.

The BSS shall compare the talker priority received in an UPLINK SEIZED COMMAND message with the current talker priority. The BSS shall update the current talker priority when the priority in the UPLINK SEIZED COMMAND message is greater than the current talker priority, and releases the uplink for an MS being pre-empted if it is served by this BSS. The BSS shall discard an UPLINK SEIZED COMMAND message that contains a talker priority that is less than or equal to the current talker priority.

When the uplink request pre-empts the current talker, the MSC shall send a CLEAR COMMAND to the talker that is being pre-empted, if the current talker is on a dedicated channel. The cause field shall be set to "Call Control".

#### 3.1.24a.2.1.3 Privileged or Emergency Priority Request via Priority Uplink Request procedure

On reception of a request to talk with privileged or emergency priority, the BSS sends an UPLINK REQUEST message to the MSC. The UPLINK REQUEST message shall include the MS identity.

The MSC sends the UPLINK REQUEST ACKNOWLEDGE message to confirm to the BSS that the uplink is granted to the requesting MS. This message shall contain the talker priority so that the BSS is able to determine which uplink request is being acknowledged. It shall also contain the status of the emergency mode. The BSS shall update the current talker priority when the priority in the UPLINK REQUEST ACKNOWLEDGE message is greater than the current talker priority, and release the uplink for an MS being pre-empted if it is served by this BSS.

The MSC also sends to all the other BSSs in the voice group call an UPLINK SEIZED COMMAND message, containing the talker priority. Additionally, if the uplink priority was "Emergency", then the UPLINK SEIZED COMMAND message shall also contain the Emergency Set Indication IE.

The BSS shall compare the talker priority received in an UPLINK SEIZED COMMAND message with the current talker priority. The BSS shall update the current talker priority when the priority in the UPLINK SEIZED COMMAND message is greater than the current talker priority, and release the uplink for an MS being pre-empted if it is served by this BSS. The BSS shall discard an UPLINK SEIZED COMMAND message that contains a talker priority that is less than or equal to the current talker priority.

The BSS sends the UPLINK CONFIRM message with the Layer 3 information once the link to the requesting MS has been established on the radio interface. The Layer 3 information shall include the MS identity and may include the ciphering key sequence number.

### 3.1.24a.2.2 Unsuccessful uplink allocation operation

#### 3.1.24a.2.2.1 Normal Priority Uplink Request

Behaviour is as defined in 3.1.24.1.2.



Additionally, in the case the UPLINK REQUEST message contained a talker priority that was less than or equal to the current talker priority that is stored in the MSC, the MSC sends an UPLINK REJECT COMMAND message to the appropriate BSS, containing the priority that was in the UPLINK REQUEST message that was being rejected and the current talker priority. The cause field shall be set to "Call Control". On reception of this message the BSS will release the uplink for the requesting MS that is being rejected, if not already released. The BSS shall set its current talker priority to the current talker priority that was received in the UPLINK REJECT COMMAND message.

The BSC shall compare the talker priority received in an UPLINK SEIZED COMMAND message with the current talker priority. If the priority is less than the current priority, then the BSC shall discard the command.

#### 3.1.24a.2.2.2 Privileged or Emergency Uplink Request via Uplink Access procedure

In the case that the radio link could not be established the BSS sends the Uplink release indication with the cause "Radiolink interface message failure".

In the case the MSC does not want to grant the uplink, the MSC will send an UPLINK REJECT COMMAND message to the appropriate BSS. The UPLINK REJECT COMMAND message shall contain the talker priority of the request that is being rejected together with the current talker priority so that the BSS is able to determine which uplink request is rejected. On reception of this the BSS will release the uplink for the requesting MS, if not already released, and set the current talker priority to the value of the priority in the Current Talker Priority IE received in the UPLINK REJECT COMMAND message.

In the case the UPLINK REQUEST message contained a talker priority that was less than or equal to the current talker priority that is stored in the MSC, the MSC sends an UPLINK REJECT COMMAND message to the appropriate BSS, containing the priority that was in the UPLINK REQUEST that was being rejected and the current talker priority. The cause field shall be set to "Call Control". On reception of this the BSS will release the uplink for the requesting MS and set the current talker priority to the value of the priority in the Current Talker Priority IE received in the UPLINK REJECT COMMAND message.

If an MSC receives an UPLINK REQUEST message, but either no mobile station identity is provided in the Layer 3 information or the mobile station is not permitted to send the requested priority, then the MSC shall send an UPLINK REJECT COMMAND message to the appropriate BSS, containing the requested priority and the current talker priority. The cause field shall be set to "Requested option not authorised". On reception of this the BSS will release the uplink for the requesting MS and set the current talker priority to the value of the priority in the Current Talker Priority IE received in the UPLINK REJECT COMMAND message.

#### 3.1.24a.2.2.3 Privileged or Emergency Uplink Request via Priority Uplink Request procedure

All other cases are as per sub-clause 3.1.24a.2.2.2, with the exception that there is no uplink for the BSS to release.

### 3.1.24a.3 Uplink release procedure

Behaviour is as defined in 3.1.24.2.

### 3.1.24a.4 Uplink seize procedure

This procedure shall be used by the MSC to inform a given BSS that the uplink has been successfully granted to a talking subscriber in another BSS area. To initiate the procedure the MSC sends UPLINK SEIZED COMMAND message to that given BSS. The UPLINK SEIZED COMMAND message shall contain the current talker priority and the status of the emergency mode. On reception of the UPLINK SEIZED COMMAND message the BSS will initiate the radio interface uplink busy procedure.

### 3.1.24a.5 Emergency Reset procedure via UPLINK ACCESS message

#### 3.1.24a.5.0 Successful

On reception a request to reset the emergency mode, the BSS sends an EMERGENCY RESET INDICATION message to the MSC. The BSS sends the EMERGENCY RESET INDICATION message with the Layer 3 information once the link has been established on the radio interface. The Layer 3 information shall include the MS identity and may include the ciphering key sequence number.

When the MSC receives a EMERGENCY RESET INDICATION message and the emergency mode is set, the MSC shall check that the mobile is allowed to issue the command. If the emergency mode is set and the mobile is allowed to issue the command, then the MSC shall send an EMERGENCY RESET COMMAND message to each BSS involved in the group call.

The BSS on receipt of the EMERGENCY RESET COMMAND message shall reset the emergency mode.

### 3.1.24a.5.1 Unsuccessful

The MSC shall discard the EMERGENCY RESET INDICATION message if the emergency mode is not set or the mobile station is not allowed to issue the command.

## 3.1.24a.6 Emergency Reset procedure via PRIORITY UPLINK REQUEST message

### 3.1.24a.6.0 Successful

On reception of a request to reset the emergency mode, the BSS sends an EMERGENCY RESET INDICATION message to the MSC. The EMERGENCY RESET INDICATION message shall include the MS identity.

When the MSC receives an EMERGENCY RESET INDICATION message and the emergency mode is set, the MSC shall check that the mobile is allowed to issue the command. If the emergency mode is set and the mobile is allowed to issue the command, then the MSC shall send an EMERGENCY RESET COMMAND message to each BSS involved in the group call.

The BSS on receipt of the EMERGENCY RESET COMMAND message shall reset the emergency mode.

### 3.1.24a.6.1 Unsuccessful

As per subclause 3.1.24a.5.1

## 3.1.24b Talker Information

The MSC may send a VGCS ADDITIONAL INFORMATION message containing information regarding the identity of the current talker to each BSS in the group call area. Each of these VGCS ADDITIONAL INFORMATION messages is sent on the group call's call controlling SCCP connection. In the case that the VGCS talker that is being pre-empted is on a dedicated channel, the MSC sends a VGCS ADDITIONAL INFORMATION message on the VGCS talker's dedicated SCCP connection.

On reception of the VGCS ADDITIONAL INFORMATION message on the group call's call controlling SCCP connection, the BSS will initiate the transmission of the additional information on the radio interface in each cell in which the group call is active.

On reception of the VGCS ADDITIONAL INFORMATION message on the VGCS talker's dedicated SCCP connection, the BSS will initiate the transmission of the additional information on the VGCS talker's dedicated channel.

The MSC may also send the talker information (talker identity IE) in the UPLINK SEIZED COMMAND, UPLINK REQUEST ACKNOWLEDGE or UPLINK REJECT COMMAND messages. On reception of an UPLINK SEIZED COMMAND, UPLINK REQUEST ACKNOWLEDGE or UPLINK REJECT COMMAND message containing the talker identity IE, the BSC will initiate the transmission of the additional information on the radio interface in each cell in which the group call is active.

## 3.1.24c SMS to ongoing VGCS call all

The MSC may send a short message to the members that are participating in the voice group call by sending one or more VGCS SMS messages to each BSS that is in the group call area. Each VGCS SMS message transports a RP-Data message (see 3GPP TS 24.011) containing all or part of the short message. The VGCS SMS message is sent on the group call's call controlling SCCP connection.

On reception of the VGCS SMS message on the group call's call controlling SCCP connection, the BSS will initiate the transmission of the RP-Data message on the VGCS group channel in each cell in which the group call is active. In the

case that the VGCS talker is on a dedicated channel the BSC will also initiate the transmission of the RP-Data message on the VGCS talker's dedicated channel.

### 3.1.24d Distributing application-specific data to ongoing VGCS call

On reception of a Data Indication message or Data Indication 2 message (see 3GPP TS 44.018) an UPLINK APPLICATION DATA message may be sent from the BSS to the MSC on the group call's call controlling SCCP connection.

On reception of an UPLINK APPLICATION DATA message from a BSS, the MSC may send a NOTIFICATION DATA message containing application-specific data and optionally the sender's mobile identity to each BSS in the group call area. Each of these NOTIFICATION DATA messages is sent on the group call's call controlling SCCP connection.

On reception of a NOTIFICATION DATA message on the group call's call controlling SCCP connection, the BSS shall broadcast the notification data to all listeners and the talker by initiating the transmission of the data on the radio interface to each cell in which the group call is active (see 3GPP TS 44.018).

Optionally the BSS may distribute the application-specific data immediately, upon receiving the application data from the MS. The application data will then be distributed to the cells within the BSS area belonging to the group call area the BSS shall indicate this in the Application Data Information IE to the MSC. In this case, the MSC shall not send the NOTIFICATION DATA message to that BSS.

### 3.1.25 PDSS1 flow control

The purpose of the PDSS1 flow control procedure is to inform the MSC that it should stop or resume transmission of PDSS1 data on this particular transaction.

The BSS may on the relevant SCCP connection associated with an MS transaction send a SUSPEND message to the MSC to ask the MSC not to transmit DTAP messages carrying air interface layer 3 messages of the PDSS1 protocol. A typical reason is that too many messages are scheduled for transmission on the air interface.

The BSS may on the relevant SCCP connection associated with an MS transaction send a RESUME message to the MSC to indicate to the MSC that DTAP messages carrying air interface layer 3 messages of the PDSS1 protocol may be transmitted (the typical reason is that congestion on the air interface signalling channel does no more exist).

### 3.1.26 Circuit re-selection procedure

This procedure has to be supported by a BSS if and only if it allocates the A interface circuits.

The MSC can request the BSS to change the circuit allocated to a connection by sending a CHANGE CIRCUIT message to the BSS on the corresponding SCCP connection. The MSC releases the allocated circuit at the sending of the CHANGE CIRCUIT message.

The MSC shall not start the circuit re-selection procedure if another procedure is on-going that may result in the change of the circuit (e.g. circuit re-selection, handover or clearing).

At the reception of a CHANGE CIRCUIT message, and if the BSS is not already engaged in a procedure that normally results in the release of the allocated circuit (e.g. handover or clearing), the BSS allocates a new circuit and indicates it in CHANGE CIRCUIT ACKNOWLEDGE message sent back to the MSC. The BSS releases the previously allocated circuit after the sending of the CHANGE CIRCUIT ACKNOWLEDGE message.

If the MSC receives a message from the BSS indicating the start of a procedure that may result in the change of the circuit (e.g. reception of HANDOVER REQUIRED or CLEAR REQUEST), the MSC shall abort the circuit re-selection procedure.

The MSC may not be able to use the terrestrial resource that the BSS has indicated. In this case, the procedure is nevertheless considered terminated successfully, and it is up to the MSC to correct the situation, e.g., by a new circuit re-selection procedure.

### 3.1.27 LSA handling

The MSC may send the LSA INFORMATION message at any time during the lifetime of the relevant SCCP connection. The message is not acknowledged.

The BSS shall store the LSA identity list internally for the connection and use it for the control of internal and external handover.

In the case of overlapping LSAs, the LSA identity signalled in messages by the BSS towards the MSC shall be the LSA identity with the highest priority.

Upon reception of a new lists of LSA identities the BSS will discard the previous LSA identity list and use the new LSA identity list. The BSS shall always accept the LSA identity list, but shall ignore LSA identities, which are not known.

If the subscriber has LSA only access this has to be taken into account in the "Cell Identifier List (preferred)" in the HANDOVER REQUIRED message (see sub-clause "Generation of the HANDOVER REQUIRED message"). If the subscriber has LSA only access the LSA only access indicator is set to zero at an emergency call.

Exclusive access cells may be included into "Cell Identifier List (preferred)" in the HANDOVER REQUIRED message (see sub-clause "Generation of the HANDOVER REQUIRED message") if at least one LSA identity defined in the exclusive access cell corresponds to any LSA identity received in the HANDOVER REQUEST or the latest LSA INFORMATION message. Exclusive access cells may also be included if the connection is an emergency call.

### 3.1.28 Location Acquisition

This procedure is utilized to support Location Services (see 3GPP TS 43.071). It is used to pass information transparently between the SMLC and BSS and request location of the target MS from the BSS.

#### 3.1.28.1 (void)

#### 3.1.28.2 Location request

##### 3.1.28.2.1 Successful Operation

PERFORM LOCATION REQUEST message may be sent in order to perform location procedure for the target MS. This message may be sent from the MSC to the BSS. This message may contain the following information:

- Location type;
- GANSS Location type
- Cell Identifier;
- Classmark Information Type 3;
- LCS Client Type;
- Chosen Channel;
- LCS Priority;
- Quality of service;
- GPS Assistance Data;
- GANSS Assistance Data;
- APDU, variable length octet string of which content is defined in 3GPP TS 49.031 and 3GPP TS 48.071;
- IMSI;
- IMEI.

On receipt of the PERFORM LOCATION REQUEST message for positioning of the target MS, the BSS transfers the positioning request to the SMLC according to the procedures defined in 3GPP TS 43.059 and 3GPP TS 49.031 and awaits the result. The BSS then returns the result of positioning to the MSC in the PERFORM LOCATION RESPONSE message. This message contains following information:

- Location estimate;
- Velocity estimate;
- Positioning data;
- GANSS positioning data.

If assistance data was instead requested by the MSC for an MS, the BSS transfers the request to the SMLC according to the procedures defined in 3GPP TS 43.059 and 3GPP TS 49.031 and awaits the result. If the SMLC was able successfully to transfer this to the MS, the BSS shall return a PERFORM LOCATION RESPONSE message to the MSC. This message shall contain no parameters. The absence of an LCS Cause parameter in this case implies that the transfer was successful.

Otherwise, if a deciphering keys were requested for LCS broadcast assistance data, the BSS transfers the request to the SMLC according to the procedures defined in 3GPP TS 43.059 and 3GPP TS 49.031 and awaits the result. If the SMLC has access to the appropriate keys, the BSS shall return a PERFORM LOCATION RESPONSE message to MSC. This message contains following information:

- Deciphering Keys.

### 3.1.28.2.2 Unsuccessful Operation

If the BSS fails to respond to the PERFORM LOCATION REQUEST message it returns a PERFORM LOCATION RESPONSE message with a LCS cause value indicating the failure cause. Possible failure causes are listed in 3GPP TS 49.031.

### 3.1.28.2.3 Abnormal cases

The following condition may occur:

If the MSC needs to abort previously initiated location request, it shall send the PERFORM LOCATION ABORT message to the BSS. As a result of reception of this message the BSS shall abort activities related to positioning of the target MS or assistance data delivery. The BSS shall return a PERFORM LOCATION RESPONSE with a cause value indicating the abortion of location request.

### 3.1.28.2.4 Overload

For location requests initiated by the MSC, the BSC may employ the same procedures defined for an SMLC in 3GPP TS 49.031 to alleviate an overload condition in the BSS.

## 3.1.29 Connectionless Information Transfer procedure

The SMLC may send information to another SMLC transparently via the BSS, or via BSS and MSC.

The CONNECTIONLESS INFORMATION message shall be sent via the BSSMAP as a connectionless message.

The BSS shall send the CONNECTIONLESS INFORMATION message to the MSC with the following information:

- Network Element Identity (source), which define the source SMLC for the message;
- Network Element Identity (target), which define the target SMLC for the message;
- Variable length octet string (APDU IE), of which content is defined in 3GPP TS 49.031;
- Segmentation IE containing segmentation and message identification: included only with a segmented APDU;
- The Return Error Request may be included to request notification in the event of unsuccessful transfer.

On receipt of the CONNECTIONLESS INFORMATION message, the MSC transmits this message to another MSC or BSS on a direct path to the target SMLC, as derived from the Network Element Identity (target) IE. The contents of APDU IE is transparent to the MSC.

If the source SMLC and the target SMLC are associated with different MSCs, then the CONNECTIONLESS INFORMATION message shall be forwarded between MSCs via the BSSMAP-LE as a connectionless message (see 3GPP TS 49.031).

### 3.1.29.1 Unsuccessful Operation

Unsuccessful operation is specified within Connectionless Information Transfer procedure in 3GPP TS 49.031.

### 3.1.29.2 Abnormal cases

Abnormal cases are specified within Connectionless Information Transfer procedure in 3GPP TS 49.031.

### 3.1.29.3 Segmentation

The Segmentation parameter shall not be included if the APDU is not segmented.

If the size of an embedded SMLCPP message is too large to fit into one CONNECTIONLESS INFORMATION message, the sending entity divides the SMLCPP message to a necessary number of CONNECTIONLESS INFORMATION messages each containing an APDU IE and a Segmentation IE. In the APDU IE it includes as many octets as possible.

The segmentation IE contains a segment number, an indication of the final segment and the message ID. The order number of a segment in the Segment Number field in the SEGMENTATION IE is incremented by one starting from zero, i.e. the value is 0 for the first segment, 1 for the next and so on. The receiving entity recognizes that a segment is missing or duplicated, when:

- There is more than one segment with the same segment number and same Message ID;
- The segment number does not increase by steps of one starting from zero.

If the recipient recognizes a missing or duplicated element, it shall discard the entire message (i.e. all received segment with the message ID).

The message identity in the Message ID field in the SEGMENTATION IE is used to recognize a particular message to which the segment belongs. The sending entity can select any of the available values (0 - 65535) that is not currently used between it and the receiving entity.

If an APDU segment is received with Return Error cause IE (due to invocation of the return error option), reassembly does not apply and the APDU segment and error cause may be returned to the original source application.

## 3.1.30 Common ID

The purpose of the Common ID procedure is to inform the BSC about the IMSI of a user. This may be used by the BSC to e.g. create a reference between the user and the RR and SCCP connections of that user for paging co-ordination. The procedure uses connection oriented signalling.

An MSC may send a COMMON ID message as soon as the SCCP connection has been established.

If the MS, the BSS and the MSC support DTM and as soon as the IMSI is available at the MSC, the MSC shall send the COMMON ID message to the BSS.

The BSC associates the permanent identity to the RR and SCCP connections of that user for the duration of the RR connection.

## 3.1.31 VGCS/VBS Cell Re-established - no A-interface link sharing

If the condition is removed, that caused the sending of the VGCS/VBS ASSIGNMENT STATUS message indicating that the cell is released for the voice group or broadcast call, the BSS shall inform the MSC of the recovery by sending

it a VGCS/VBS ASSIGNMENT STATUS message, indicating that the voice group or broadcast call has been established in the cell.

The BSS shall reallocate a radio resource for the group channel and initiate the radio interface notification procedure on the NCH of the cell in which the call is to take place. The notification procedure may continue at regular intervals until the call is released or the cell has been released for the voice group or broadcast call.

When the MSC receives a VGCS/VBS ASSIGNMENT STATUS message it shall update its record of the status of the cell.

### 3.1.32 Rerouting procedure in case of MOCN configuration for network sharing

#### 3.1.32.1 General

This procedure shall be supported by a BSS if and only if it supports the MOCN configuration (see [52]).

In the MOCN configuration the radio access part of the network is shared. There may be more than one A-Interface towards the CS domain of different CN operators from the BSS.

Rerouting procedure is a mechanism used as part of the assignment of CN operator in shared networks with MOCN configuration when they perform initial attach/registration. In this case BSS may not know towards which MSC to route the initial MS request message and the latter may be rerouted to another MSC by BSS.

More precisely, in case of MOCN configuration, the selection of MSC in BSS is based on the NRI (valid or invalid) or by random selection. In case where the MSC cannot be deduced from the NRI and a LOCATION UPDATING REQUEST initial layer 3 message shall be transferred in COMPLETE LAYER 3 INFORMATION message towards an MSC, BSS shall choose an MSC and initiate a rerouting procedure.

To trigger a rerouting procedure in MOCN configuration, the BSS adds the Redirect Attempt Flag to the COMPLETE LAYER 3 INFORMATION, in order to indicate that the MSC shall respond with a REROUTE COMMAND message or a REROUTE COMPLETE message.

#### 3.1.32.2 Reroute command

If the MSC cannot serve the request and reroute is possible (error causes are related to subscription options - defined in [6]), the reject Layer 3 Information (e.g. Location Updating Reject) shall be included in the REROUTE COMMAND message for the downlink direction.

When the IMSI is not included in the COMPLETE LAYER 3 INFORMATION message and CS/PS domain registration coordination is required (see [52]), the Initial Layer 3 Information shall be included in the REROUTE COMMAND message for the downlink direction and Reroute Reject Cause shall be set to "CS/PS domain registration coordination required". CS/PS domain registration coordination may not be performed for the operator's own subscribers by the MSC.

In addition the REROUTE COMMAND shall contain:

- The Initial Layer 3 Information received from the MS;
- The Reroute Reject Cause;
- The Send Sequence Number, if available;
- The IMSI, if available.

In MOCN configuration, if the BSS receives the REROUTE COMMAND message from an MSC which is not the last attempted, it shall initiate the Initial MS Message procedure towards another CN operator when possible (or possibly to the same CN in case when CS/PS domain registration coordination is required), with the following additional information in the COMPLETE LAYER 3 INFORMATION message:

- Redirect Attempt Flag
- The Send Sequence Number, if received from previously attempted CN operator;

- IMSI, if received from one of previously attempted CN operators.

Upon reception of the downlink REROUTE COMMAND message, the BSC shall store as part of the Rerouting Function the associated Reroute Reject Cause and Layer 3 Information related to this MSC. In case the Reroute Reject Cause is set to "CS/PS domain registration coordination required", then the BSC shall perform CS/PS domain registration coordination based on the received IMSI. In this case the Reroute Reject Cause value and the associated Layer 3 Information shall not be stored.

In case all attempted CN operators have replied with REROUTE COMMAND message, the BSC shall select the most appropriate Layer 3 Information received from the attempted CN nodes based on the stored information as part of the Rerouting procedure and send it back to the MS (see [6]).

### 3.1.32.3 Reroute complete

If the MSC can serve the request, the Layer 3 Information (e.g. Location Updating Accept) shall be sent to the mobile station as a DTAP message and the REROUTE COMPLETE message with the reroute complete outcome IE set to "MS is accepted" or "MS is already registered" shall be sent to the BSS to complete the Rerouting procedure.

Upon reception of the downlink REROUTE COMPLETE message, the BSC shall terminate the Rerouting procedure.

### 3.1.32.4 Abnormal Conditions

If the MSC cannot serve the request and rerouting is not possible, the MSC shall send to the mobile station the DTAP layer 3 information (e.g. Location Updating Reject) message and the MSC shall send to the BSS the REROUTE COMPLETE message with the reroute complete outcome IE set to "MS is not accepted".

## 3.1.33 Local Call Local Switch

### 3.1.33.1 General

Local Call Local Switch (LCLS) provides the capability for the user plane to be locally switched within the BSS for calls that are generated and terminated by users served by the same BSS (see 3GPP TS 23.284).

### 3.1.33.2 Local switch establishment

#### 3.1.33.2.1 Call Leg Correlation

Call Leg Correlation is the process of determining if another call leg exists in the BSS with the same Global Call Reference (GCR) value. The BSS may perform call leg correlation in a number of steps as described in 3GPP TS 23.284.

If the BSS receives the LCLS-Correlation-Not-Needed IE in the ASSIGNMENT REQUEST message during the assignment procedure (see sub-clause 3.1.1), it may act upon this and just store the GCR value, or it may ignore the LCLS-Correlation-Not-Needed IE and perform a full call leg correlation.

If the BSS successfully correlates two call legs it shall indicate this to the core network by setting the LCLS-BSS-Status IE to "Call not yet locally switched". If the call leg correlation is not successful the BSS shall return the LCLS-BSS-Status IE with "Call not possible to be locally switched".

#### 3.1.33.2.2 Successful Operation

The BSS may only establish local switching when following conditions are met:

- the BSS has successfully correlated two call legs, see sub-clause 3.1.33.2.1.
- the BSS has received LCLS-Configuration IE on both call legs of the local call, and the requested LCLS configuration is supported in the BSS.
- the BSS has received LCLS-Connection-Status-Control IE with value "Connect" on both call legs of the local call.

The LCLS-Configuration IE defines the user data connectivity for the given call leg as follows:



- if the LCLS configuration requested by the MSC indicates "Connect both-way", then the BSS shall pass user data between the locally switched call legs without sending any user data to the core network or expecting to receive any user data from the core network.
- if the LCLS configuration requested by the MSC indicates "Connect both-way and bi-cast UL to the core network", then the BSS shall pass user data between the locally switched call legs and send UL user data to the core network but not expect to receive any user data from the core network.
- if the LCLS configuration requested by the MSC indicates "Connect both-way and send access DL from the core network", then the BSS shall pass user data between the locally switched call legs, detect incoming user data from the core network and insert the user data into the user data stream towards the served user. Any local DL user data received may be pre-empted while delivering DL user data from the core network. How this is performed is implementation dependent. The BSS shall not send UL user data to the core network.
- if the LCLS configuration requested by the MSC indicates "Connect both-way and send access DL from the core network, block local DL user data", then the BSS shall send user data to the locally switched call leg and pass incoming user data from the core network towards the served user while blocking local DL user data. The BSS shall not send UL user data to the core network.
- if the LCLS configuration requested by the MSC indicates "Connect both-way and bi-cast UL to the core network with send access DL from the core network", then the BSS shall pass user data between the locally switched call legs, detect incoming user data from the core network and insert the user data into the user data stream towards the served user and send UL user data to the core network. Any local DL user data received may be pre-empted while delivering DL user data from the core network. How this is performed is implementation dependent.
- if the LCLS configuration requested by the MSC indicates "Connect both-way and bi-cast UL to the core network with send access DL from the core network, block local DL user data", then the BSS shall send user data UL both to the core network and to the locally switched call leg and pass incoming user data from the core network towards the served user while blocking local DL user data.

The BSS shall inform the MSC of a successful local switch connection by setting the LCLS-BSS-Status IE to "Call is locally switched with requested LCLS configuration" in the LCLS-CONNECT-CONTROL-ACK message or in the appropriate BSSAP message (see sub-clause 3.1.1, 3.1.5, 3.1.6 and 3.1.7). The BSS shall also inform the MSC serving the other call leg of the locally switched call using the LCLS-NOTIFICATION message, see sub-clause 3.1.33.5.

If at any time the LCLS connection status for a call leg is changed in the BSS, the new LCLS connection status value shall be reported to the MSC according to sub-clause 3.1.33.5.

### 3.1.33.2.3 Unsuccessful Operation

If a message which includes LCLS-Configuration IE is received in the BSS, the BSS shall check whether it can support the requested LCLS configuration. If the BSS does not support the requested LCLS configuration, then the BSS shall indicate this to the MSC by setting the LCLS-BSS-Status IE to "Requested LCLS configuration is not supported" in the LCLS-CONNECT-CONTROL-ACK message or in the appropriate BSSAP response message (see sub-clause 3.1.1 and 3.1.5).

However, even if the BSS does not support the requested LCLS configuration the BSS shall store the received GCR value (or replace the previously stored GCR value) included in the Global Call Reference IE since the MSC may renegotiate the LCLS configuration without re-sending the Global Call Reference IE.

If the MSC has granted the permission to apply local switching, the BSS makes the final decision whether or not to establish local switching. If the BSS is not able to establish local switching it shall indicate this to the MSC by setting the LCLS-BSS-Status IE to value "Call not yet locally switched" in the LCLS-CONNECT-CONTROL-ACK message or in the appropriate BSSAP message (see sub-clause 3.1.1, 3.1.5, 3.1.6 and 3.1.7).

### 3.1.33.3 Local switch break

#### 3.1.33.3.1 Local switching break request from MSC

If the MSC initiates break of local switching, the MSC sends the LCLS-CONNECT-CONTROL message with the LCLS-Connection-Status-Control IE set to "Release LCLS" on both call legs of the locally switched call.

On receipt of the LCLS-CONNECT-CONTROL message with the LCLS-Connection-Status-Control IE set to "Release LCLS" the BSS shall only break local switching if the message is received on both call legs of the locally switched call. At reception of the LCLS break request for the first call leg (i.e. before the LCLS break request is received for the second call leg) the BSS shall report to the MSC by sending the LCLS-CONNECT-CONTROL-ACK message with the present LCLS connection status value included in the message. At reception of the LCLS break request for the second call leg (and a corresponding LCLS break request is already received for the first call leg associated to the locally switched call), the BSS shall break local switching and report the LCLS disconnection to the MSC by sending the LCLS-CONNECT-CONTROL-ACK message on this call leg, and the LCLS-NOTIFICATION message on the other call leg (see sub-clause 3.1.33.5), with the LCLS-BSS-Status IE set to "Call is no longer locally switched" included in both messages.

### 3.1.33.3.2 Local switching break initiated by BSS

If the BSS determines that local switching should be disconnected, the BSS may:

- immediately break local switching and then inform the MSC on both call legs by sending the LCLS-NOTIFICATION message (see sub-clause 3.1.33.5) with the LCLS-BSS-Status IE set to "Call is no longer locally switched" included in the message, or
- first request the MSC to prepare for LCLS break (see sub-clause 3.1.33.5) and on the reception of LCLS break request on both call legs the BSS breaks local switching, see sub-clause 3.1.33.3.1.

### 3.1.33.3.3 Local Switching break at Handover

If a call is locally switched and an inter-BSS handover or an inter-system handover is performed for one of the call legs then local switching is broken and normal core network switched user plane is resumed. The locally switched call may also be broken as a result of an internal handover within the BSS.

If during the handover procedure the BSS receives the LCLS-CONNECT-CONTROL message with the LCLS-Connection-Status-Control IE set to "Bi-cast at Handover", then the BSS shall initiate UL user data transmission to this call leg in addition to sending user data to the other locally switched call leg. The BSS shall continue to send user data to the other locally switched call leg until local switching is released. From this point in time the BSS shall also be prepared to receive user data DL from the core network.

When the locally switched call is released, the BSS shall for the call leg not being part in the handover procedure revert to the previously defined LCLS connection status value requested by the MSC (i.e. which was valid before receiving the LCLS-CONNECT-CONTROL message with the LCLS-Connection-Status-Control IE set to "Bi-cast at Handover") and maintain the LCLS configuration setting to be able to resume local switching if e.g. the distant call leg (in case of an inter-BSS or an inter-system handover) performs a subsequent handover back to the same BSS.

If the BSS has not received an explicit indication to start bi-casting of user data UL to the core network in the LCLS-CONNECT-CONTROL message, the BSS shall at reception of the BSSMAP HANDOVER COMMAND message or INTERNAL HANDOVER COMMAND message start UL transmission of user data to the core network on the other call leg (i.e. the call leg not being handed over) of the locally switched call.

### 3.1.33.4 Local switch prevention

The MSC may at any time prevent the BSS from establishing local switching by setting the LCLS-Connection-Status-Control IE to "Do not connect".

### 3.1.33.5 LCLS Notification

When the LCLS connection status is changed in the BSS for a call leg for which the BSS has reported that it supports the LCLS configuration requested from the MSC, the new LCLS connection status value shall be explicitly reported to the MSC in the LCLS-NOTIFICATION message (unless the changed LCLS connection status can be returned in another BSSAP response message). Valid LCLS connection status values are defined in sub-clause 3.2.2.119.

In the event of disconnecting local switching in the BSS, a request for LCLS break may be sent to the MSC. The BSS sends the LCLS-NOTIFICATION message to the MSC on both call legs with the LCLS-Break-Request IE present in the message.

## 3.2 Message Formats and Coding

This sub-clause defines the coding and format of the messages required for the BSSMAP.

For each message there is, in sub-clause 3.2.1, a table listing the signalling elements in their order of appearance in the transmitted message.

There is no general rule for the order of signalling elements: it happens that the same elements appear in various orders depending on the message.

All the BSSMAP messages are listed in the following table.

Message name	Reference
ASSIGNMENT REQUEST	3.2.1.1
ASSIGNMENT COMPLETE	3.2.1.2
ASSIGNMENT FAILURE	3.2.1.3
CHANNEL MODIFY REQUEST	3.2.1.75
BLOCK	3.2.1.4
BLOCKING ACKNOWLEDGE	3.2.1.5
CIRCUIT GROUP BLOCK	3.2.1.41
CIRCUIT GROUP BLOCKING ACKNOWLEDGE	3.2.1.42
CIRCUIT GROUP UNBLOCK	3.2.1.43
CIRCUIT GROUP UNBLOCKING ACKNOWLEDGE	3.2.1.44
CLEAR COMMAND	3.2.1.21
CLEAR COMPLETE	3.2.1.22
CLEAR REQUEST	3.2.1.20
UNBLOCK	3.2.1.6
UNBLOCKING ACK	3.2.1.7
HANDOVER CANDIDATE ENQUIRE	3.2.1.14
HANDOVER CANDIDATE RESPONSE	3.2.1.15
HANDOVER REQUEST	3.2.1.8
HANDOVER REQUIRED	3.2.1.9
HANDOVER REQUIRED REJECT	3.2.1.37
HANDOVER REQUEST ACKNOWLEDGE	3.2.1.10
HANDOVER COMMAND	3.2.1.11
HANDOVER COMPLETE	3.2.1.12
HANDOVER SUCCEEDED	3.2.1.13
HANDOVER FAILURE	3.2.1.16
HANDOVER PERFORMED	3.2.1.25
HANDOVER DETECT	3.2.1.40
RESOURCE REQUEST	3.2.1.17
RESET	3.2.1.23
RESET ACK	3.2.1.24
RESOURCE INDICATION	3.2.1.18
PAGING	3.2.1.19
OVERLOAD	3.2.1.26
MSC INVOKE TRACE	3.2.1.27
BSS INVOKE TRACE	3.2.1.28
CLASSMARK UPDATE	3.2.1.29
CLASSMARK REQUEST	3.2.1.46
CIPHER MODE COMMAND	3.2.1.30
CIPHER MODE COMPLETE	3.2.1.31
CIPHER MODE REJECT	3.2.1.48
COMPLETE LAYER 3 INFORMATION	3.2.1.32
QUEUING INDICATION	3.2.1.33
SAPI "N" REJECT	3.2.1.34
RESET CIRCUIT	3.2.1.38
RESET CIRCUIT ACKNOWLEDGE	3.2.1.39
CONFUSION	3.2.1.45
UNEQUIPPED CIRCUIT	3.2.1.47
LOAD INDICATION	3.2.1.49
VGCS/VBS SETUP	3.2.1.50
VGCS/VBS SETUP ACK	3.2.1.51
VGCS/VBS SETUP REFUSE	3.2.1.52
VGCS/VBS ASSIGNMENT REQUEST	3.2.1.53
VGCS/VBS ASSIGNMENT RESULT	3.2.1.54
VGCS/VBS ASSIGNMENT FAILURE	3.2.1.55
VGCS/VBS QUEUING INDICATION	3.2.1.56
UPLINK REQUEST	3.2.1.57
UPLINK REQUEST ACKNOWLEDGE	3.2.1.58
UPLINK REQUEST CONFIRMATION	3.2.1.59
UPLINK RELEASE INDICATION	3.2.1.60
UPLINK REJECT COMMAND	3.2.1.61
UPLINK RELEASE COMMAND	3.2.1.62
UPLINK SEIZED COMMAND	3.2.1.63

Message name	Reference
SUSPEND	3.2.1.64
RESUME	3.2.1.65
CHANGE CIRCUIT	3.2.1.66
CHANGE CIRCUIT ACKNOWLEDGE	3.2.1.67
COMMON ID	3.2.1.68
LSA INFORMATION	3.2.1.69
CONNECTION ORIENTED INFORMATION	3.2.1.70
PERFORM LOCATION REQUEST	3.2.1.71
PERFORM LOCATION RESPONSE	3.2.1.72
PERFORM LOCATION ABORT	3.2.1.73
CONNECTIONLESS INFORMATION	3.2.1.74
EMERGENCY RESET INDICATION	3.2.1.76
EMERGENCY RESET COMMAND	3.2.1.77
VGCS ADDITIONAL INFORMATION	3.2.1.78
VGCS/VBS AREA CELL INFO	3.2.1.79
VGCS/VBS ASSIGNMENT STATUS	3.2.1.80
VGCS SMS	3.2.1.81
NOTIFICATION DATA	3.2.1.82
INTERNAL HANDOVER REQUIRED	3.2.1.83
INTERNAL HANDOVER REQUIRED REJECT	3.2.1.84
INTERNAL HANDOVER COMMAND	3.2.1.85
INTERNAL HANDOVER ENQUIRY	3.2.1.86
RESET IP RESOURCE	3.2.1.87
RESET IP RESOURCE ACKNOWLEDGE	3.2.1.88
REROUTE COMMAND	3.2.1.89
REROUTE COMPLETE	3.2.1.90
LCLS-CONNECT-CONTROL	3.2.1.91
LCLS-CONNECT-CONTROL-ACK	3.2.1.92
LCLS-NOTIFICATION	3.2.1.93

## 3.2.1 Message Contents

### 3.2.1.1 ASSIGNMENT REQUEST

This message is sent from the MSC to the BSS via the relevant SCCP connection in order to request the BSS to assign radio resource(s), the attributes of which are defined within the message.

The message may also include the terrestrial circuit to be used.

INFORMATION ELEMENT	REFERENCE	DIRECTION	TYPE	LEN
Message Type	3.2.2.1	MSC-BSS	M	1
Channel Type	3.2.2.11	MSC-BSS	M	5-13
Layer 3 Header Information	3.2.2.9	MSC-BSS	O (note 3)	4
Priority	3.2.2.18	MSC-BSS	O	3
Circuit Identity Code	3.2.2.2	MSC-BSS	O (note 1, 12)	3
Downlink DTX Flag	3.2.2.26	MSC-BSS	O (note 2)	2
Interference Band To Be Used	3.2.2.21	MSC-BSS	O	2
Classmark Information 2	3.2.2.19	MSC-BSS	O (note 4)	4-5
Group Call Reference	3.2.2.55	MSC-BSS	O (note 5)	7
Talker Flag	3.2.2.54	MSC-BSS	O (note 6)	1
Configuration Evolution Indication	3.2.2.57	MSC-BSS	O (note 7)	2
LSA Access Control Suppression	3.2.2.61	MSC-BSS	O (note 8)	2
Service Handover	3.2.2.75	MSC-BSS	O (note 9)	3
Encryption Information	3.2.2.10	MSC-BSS	O (note 10)	3-n
Talker Priority	3.2.2.89	MSC-BSS	O (note 11)	2
AoIP Transport Layer Address (MGW)	3.2.2.102	MSC-BSS	O (note 12)	8-20
Codec List (MSC Preferred)	3.2.2.103	MSC-BSS	O (note 13)	3-n
Call Identifier	3.2.2.105	MSC-BSS	O (note 12)	5
Kc <sub>128</sub>	3.2.2.109	MSC-BSS	C (note 15)	17
Global Call Reference	3.2.2.115	MSC-BSS	O (note 16)	3-n
LCLS-Configuration	3.2.2.116	MSC-BSS	O (note 16)	2
LCLS-Connection-Status-Control	3.2.2.117	MSC-BSS	O (note 17)	2
LCLS-Correlation-Not-Needed	3.2.2.118	MSC-BSS	O (note 18)	1

NOTE 1:	This element (Circuit Identity Code) is included, if the MSC allocates the A interface TDM-circuits and the channel type Information Element indicates speech or data, and only in those cases.
NOTE 2:	This element may be included in the case of a speech TCH, and only in this case. If not included, this has no impact on the DTX function in the BSS. This element shall be neglected by the BSS, if an IP A-Interface type is finally selected and speech transcoder resources are not allocated within the BSS.
NOTE 3:	This information element doesn't serve any useful purpose. MSCs should not send the information element unless it is required by the recipients (due to the need to interwork with older versions of the protocol). It is expected that in future versions of the present document, this information element will be deleted from this message.
NOTE 4:	These elements may be included if the information is known by the MSC.
NOTE 5:	This information element is included by the MSC if the subscriber is a talker or a listener in a group call.
NOTE 6:	This information element is included by the MSC if the subscriber is a talker in a group call.
NOTE 7:	The information is indicated by the MSC if known.
NOTE 8:	This information element is included if LSA access control function shall be suppressed in the BSS.
NOTE 9:	This information element is included if a preference for other radio access technologies shall be applied to the MS connection.
NOTE 10:	This information is only included for ciphered VGCS/VBS calls. It is only included if the assignment procedure is used to transfer the talker from a group call channel to a dedicated channel, the Group Call Reference is present, and the Group Key Number within this field is set to a value other than 'no ciphering'.
NOTE 11:	This information element is included if the network supports talker priority and uplink access option (i) (as defined in 3GPP TS 43.068) and A-interface link sharing and the Assignment Request is used to transfer the talker from a group call channel to a dedicated channel.
NOTE 12:	These IEs are not included, if the Channel Type IE indicates "signalling". The Circuit Identity Code may be included, if at least one alternative for a TDM connection is included in Codec List (MSC Preferred). The AoIP Transport Layer Address (MGW) and Call Identifier may be included, if at least one alternative for an IP connection is included in Codec List (MSC Preferred). The ASSIGNMENT REQUEST message may include both, a Circuit Identity Code and an AoIP Transport Layer Address (MGW) simultaneously. At least one of the two IEs shall be included (except if the Channel Type IE indicates "signalling"). If the Codec List (MSC Preferred) is included in Assignment Request, then the BSS shall not allocate a Circuit Identity Code on its own.
NOTE 13:	This IE is not included, if the Channel Type IE indicates "signalling". Codec List (MSC Preferred) shall be included if the core network supports an IP based user plane interface. The information in Codec List (MSC Preferred) shall be consistent with the information in Channel Type IE.
NOTE 14:	Void
NOTE 15:	This IE is included if the encryption algorithm A5/4 is indicated as permitted in the Encryption Information IE.
NOTE 16:	This IE is included if local switching is requested by the MSC.
NOTE 17:	This IE may be included if local switching is requested by the MSC to explicitly indicate the LCLS connection status requested. If this IE is not included then through-connection of the two call legs is not permitted.
NOTE 18:	This IE may be included if local switching is requested by the MSC and one of the options "intra-Network Call Detection" or "intra-BSS Call Detection" are supported by the MSC (see 3GPP TS 23.284). This IE is optional for the BSS to support.

### 3.2.1.2 ASSIGNMENT COMPLETE

The ASSIGNMENT COMPLETE message is sent from the BSS to the MSC and indicates that the requested assignment has been completed correctly.

The message is sent via the BSSAP SCCP connection associated with the dedicated resource(s).

INFORMATION ELEMENT	REFERENCE	DIRECTION	TYPE	LEN
Message Type	3.2.2.1	BSS-MSC	M	1
RR Cause	3.2.2.22	BSS-MSC	O	2
Circuit Identity Code	3.2.2.2	BSS-MSC	O (note 4)	3
Cell Identifier	3.2.2.17	BSS-MSC	O (note 1)	3-10
Chosen Channel	3.2.2.33	BSS-MSC	O (note 3)	2
Chosen Encryption Algorithm	3.2.2.44	BSS-MSC	O (note 5)	2
Circuit Pool	3.2.2.45	BSS-MSC	O (note 2)	2
Speech Version (Chosen)	3.2.2.51	BSS-MSC	O (note 6)	2
LSA Identifier	3.2.2.15	BSS-MSC	O (note 7)	5
Talker Priority	3.2.2.89	BSS-MSC	O (note 8)	2
AoIP Transport Layer Address (BSS)	3.2.2.102	BSS-MSC	O (note 9)	8-20
Speech Codec (Chosen)	3.2.2.104	BSS-MSC	O (note 10)	3-5
Codec List (BSS Supported)	3.2.2.103	BSS-MSC	O (note 11)	3-n
LCLS-BSS-Status	3.2.2.119	BSS-MSC	O (note 12)	2
<p>NOTE 1: The cell identifier is used to indicate a new cell, if during the assignment the serving cell has changed. When sent from 3G_MSC-B over MAP/E interface this information element contains indication of Cell Identifier (e.g. CGI) if the new serving cell is GSM or indication of either RNC-ID (or Extended RNC-ID) or SAI (if known) if the new serving cell is UMTS. Note: RNC-ID (or Extended RNC-ID) or SAI are only provided in the ASSIGNMENT COMPLETE message over the MAP-E interface.</p> <p>NOTE 2: Shall be included when several circuit pools are present on the BSS MSC interface and a circuit was allocated by the ASSIGNMENT REQUEST message.</p> <p>NOTE 3: Included at least when the channel rate/type choice was done by the BSS.</p> <p>NOTE 4: The Circuit Identity Code information element is included mandatorily by the BSS if the BSS allocates the A interface circuits and a circuit is needed. If the Codec List (MSC Preferred) was included in Assignment Request, then the BSS shall not allocate a Circuit Identity Code on its own.</p> <p>NOTE 5: Included at least when the encryption algorithm has been changed by the BSS.</p> <p>NOTE 6: Included at least when the speech version choice was done by the BSS.</p> <p>NOTE 7: Shall be included if current LSA in the serving cell has been identified (see 3GPP TS 43.073). Not included means that there is no current LSA in the serving cell.</p> <p>NOTE 8: This information element is included if the network supports talker priority and uplink access option (i) (as defined in 3GPP TS 43.068) and A-interface link sharing and the BSS has completed the transfer of the talker from a group call channel to a dedicated channel.</p> <p>NOTE 9: AoIP Transport Layer Address (BSS) shall be included if and only if the BSS has chosen an IP connection for the user plane interface. AoIP Transport Layer Address (BSS) shall not be modified if the ASSIGNMENT COMPLETE message is a response to a sub-sequent ASSIGNMENT REQUEST MESSAGE which modifies the radio interface data rate.</p> <p>NOTE 10: Speech Codec (Chosen) shall be included if the radio access network supports an IP user plane interface. This information element shall be consistent with the information in Chosen Channel, if included, and with the information in Speech Version (Chosen), if included.</p> <p>NOTE 11: Codec List (BSS Supported) may be included, if an intra-BSS cell change has occurred during the assignment.</p> <p>NOTE 12: This IE shall be included if LCLS is supported by BSS and both Global Call Reference IE and LCLS-Configuration IE were included in the ASSIGNMENT REQUEST message.</p>				



### 3.2.1.3 ASSIGNMENT FAILURE

The ASSIGNMENT FAILURE message is sent from the BSS to the MSC via the relevant SCCP connection. It indicates that there has been a failure in the assignment process at the BSS and that the assignment procedure has been aborted.

INFORMATION ELEMENT	REFERENCE	DIRECTION	TYPE	LEN
Message Type	3.2.2.1	BSS-MSC	M	1
Cause	3.2.2.5	BSS-MSC	M	3-4
RR Cause	3.2.2.22	BSS-MSC	O	2
Circuit Pool	3.2.2.45	BSS-MSC	O (note 1)	2
Circuit Pool List	3.2.2.46	BSS-MSC	O (note 2)	V
Talker Priority	3.2.2.89	BSS-MSC	O (note 3)	2
Codec List (BSS Supported)	3.2.2.103	BSS-MSC	O (note 4)	3-n
NOTE 1: Shall be included when several circuit pools are present on the BSS MSC interface.				
NOTE 2: May be included when cause is "circuit pool mismatch" or "switch circuit pool" to indicate circuit pool preferences.				
NOTE 3: This information element is included if the network supports talker priority and uplink access option (i) (as defined in 3GPP TS 43.068) and A-interface link sharing and the BSS has failed to transfer the talker from a group call channel to a dedicated channel.				
NOTE 4: Codec List (BSS Supported) should be included, if the radio access network supports an IP based user plane interface.				

Typical Cause values are:

- radio interface message failure;
- O and M intervention;
- equipment failure;
- no radio resource available;
- requested terrestrial resource unavailable;
- requested transcoding/rate adaption unavailable;
- Requested Redundancy Level not supported;
- Requested Redundancy Level not available;
- terrestrial resource already allocated;
- Call Identifier already allocated;
- invalid message contents;
- radio interface failure - reversion to old channel;
- ciphering algorithm not supported;
- directed retry;
- circuit pool mismatch;
- switch circuit pool;
- requested speech version unavailable;

Requested A-Interface Type not supported;

Requested Codec Type or Codec Configuration not supported;

Requested A-Interface Type unavailable;

Requested Codec Type or Codec Configuration unavailable;

- relocation triggered (NOTE).

NOTE: This cause value is only sent by 3G\_MSC-B over the MAP/E interface (see 3GPP TS 29.010).

### 3.2.1.4 BLOCK

This message is sent from the BSS to the MSC or from the MSC to the BSS to indicate that a particular terrestrial resource (i.e. a particular timeslot within a 2Mbit system) must be remotely blocked at the circuit master, and cannot therefore be used for traffic. This message is not relevant for an IP based user plane interface.

This message is sent as a connectionless SCCP message.

INFORMATION ELEMENT	REFERENCE	DIRECTION	TYPE	LEN
Message Type	3.2.2.1	both	M	1
Circuit Identity Code	3.2.2.2	both	M	3
Cause	3.2.2.5	both	M	3-4
Connection Release Requested	3.2.2.3	MSC-BSS	O	1

Typical Cause values are:

- no radio resource available;
- O and M intervention;
- equipment failure.

### 3.2.1.5 BLOCKING ACKNOWLEDGE

This message is sent from the MSC to the BSS or from the BSS to the MSC to acknowledge the receipt of an earlier BLOCK message, and to indicate that the circuit concerned has been removed from service. This message is not relevant for an IP based user plane interface.

This message is sent as a connectionless SCCP message.

INFORMATION ELEMENT	REFERENCE	DIRECTION	TYPE	LEN
Message Type	3.2.2.1	both	M	1
Circuit Identity Code	3.2.2.2	both	M	3

### 3.2.1.6 UNBLOCK

This message is sent from the BSS to the MSC or from the MSC to the BSS to indicate that a particular terrestrial resource (ie a particular timeslot within a 2 Mbit system) should not be remotely blocked any more on the receiver side. This message is not relevant for an IP based user plane interface.

This message is sent as a connectionless SCCP message.

INFORMATION ELEMENT	REFERENCE	DIRECTION	TYPE	LEN
Message Type	3.2.2.1	both	M	1
Circuit Identity Code	3.2.2.2	both	M	3

### 3.2.1.7 UNBLOCKING ACKNOWLEDGE

This message is sent from the MSC to the BSS or from the BSS to the MSC to acknowledge the receipt of an earlier UNBLOCK message. This message is not relevant for an IP based user plane interface.

This message is sent as a connectionless SCCP message.

INFORMATION ELEMENT	REFERENCE	DIRECTION	TYPE	LEN
Message Type	3.2.2.1	both	M	1
Circuit Identity Code	3.2.2.2	both	M	3

### 3.2.1.8 HANDOVER REQUEST

This message is sent from the MSC to the BSS via the relevant SCCP connection to indicate that the MS is to be handed over to that BSS.

INFORMATION ELEMENT	REFERENCE	DIRECTION	TYPE	LEN
Message Type	3.2.2.1	MSC-BSS	M	1
Channel Type	3.2.2.11	MSC-BSS	M	5-13
Encryption Information	3.2.2.10	MSC-BSS	M (note 1)	3-n
Classmark Information 1 or Classmark Information 2	3.2.2.30 3.2.2.19	MSC-BSS	M# M (note 6)	2 4-5
Cell Identifier (Serving)	3.2.2.17	MSC-BSS	M (note 20)	5-10
Priority	3.2.2.18	MSC-BSS	O	3
Circuit Identity Code	3.2.2.2	MSC-BSS	O (note 7, 24)	3
Downlink DTX Flag	3.2.2.26	MSC-BSS	O (note 3)	2
Cell Identifier (Target)	3.2.2.17	MSC-BSS	M (note 17)	3-10
Interference Band To Be Used	3.2.2.21	MSC-BSS	O	2
Cause	3.2.2.5	MSC-BSS	O (note 9)	3-4
Classmark Information 3	3.2.2.20	MSC-BSS	O (note 4)	3-34
Current Channel type 1	3.2.2.49	MSC-BSS	O (note 8)	2
Speech Version (Used)	3.2.2.51	MSC-BSS	O (note 10)	2
Group Call Reference	3.2.2.55	MSC-BSS	O (note 5)	7
Talker Flag	3.2.2.54	MSC-BSS	O (note 11)	1
Configuration Evolution Indication	3.2.2.57	MSC-BSS	O (note 12)	2
Chosen Encryption Algorithm (Serving)	3.2.2.44	MSC-BSS	O (note 2)	2
Old BSS to New BSS Information	3.2.2.58	MSC-BSS	O (note 13)	2-n
LSA Information	3.2.2.23	MSC-BSS	O (note 14)	3+4n
LSA Access Control Suppression	3.2.2.61	MSC-BSS	O (note 15)	2
Service Handover	3.2.2.75	MSC-BSS	O (note 21)	3
IMSI	3.2.2.6	MSC-BSS	O (note 16)	3-10
Source RNC to target RNC transparent information (UMTS)	3.2.2.76	MSC-BSS	O (note 18)	n-m
Source RNC to target RNC transparent information (cdma2000)	3.2.2.77	MSC-BSS	O (note 19)	n-m
SNA Access Information	3.2.2.82	MSC-BSS	O (note 22)	2+n
Talker Priority	3.2.2.89	MSC-BSS	O (note 23)	2
AoIP Transport Layer Address (MGW)	3.2.2.102	MSC-BSS	O (note 24)	8-20
Codec List (MSC Preferred)	3.2.2.103	MSC-BSS	O (note 25)	3-n
Call Identifier	3.2.2.105	MSC-BSS	O (note 24)	5
Kc <sub>128</sub>	3.2.2.109	MSC-BSS	C (note 27)	17
Global Call Reference	3.2.2.115	MSC-BSS	O (note 28)	3-n
LCLS-Configuration	3.2.2.116	MSC-BSS	O (note 28)	2
LCLS-Connection-Status-Control	3.2.2.117	MSC-BSS	O (note 28)	2
NOTE 1:	Except in the case of a VGCS talker, if neither a CIPHER MODE COMMAND has been sent (to a BSS) nor a SECURITY MODE COMMAND has been sent (to an RNC) for this RR/RRC connection (or if all such CIPHER MODE COMMAND messages (resp. SECURITY MODE COMMAND messages) have been rejected with CIPHER MODE REJECT messages (resp. SECURITY MODE REJECT messages)) then the MSC shall indicate that the only "permitted algorithm" is "no encryption". In the case of a VGCS talker, if the Group Key Number within the Group Call Reference is set to a value other than 'no ciphering', the MSC shall indicate the permitted algorithms and the ciphering key to use on a dedicated channel, irrespective of whether a CIPHER MODE COMMAND has been previously sent on the RR connection.			
NOTE 2:	If this information element is included, it shall be equal to the last received "Chosen Encryption Algorithm" information element. The information should be indicated by the MSC if known.			
NOTE 3:	This element may be included in the case of a speech TCH, and only in this case. If not included, this has no impact on the DTX function in the BSS. This element shall be neglected by the BSS, if an IP A-Interface type is finally selected and speech transcoder resources are not allocated within the BSS.			

NOTE 4:	This element is included if the MSC has received such information.
NOTE 5:	This element is included if the MS is in a voice broadcast or voice group call.
NOTE 6:	One of these two elements is sent.
NOTE 7:	This element (Circuit Identity Code) is included, if the MSC allocates the A interface TDM-circuits and the channel type Information Element indicates speech or data, and only in those cases. In case of Voice Group Call talker handover, this element may contain the Circuit Identity Code already allocated during the VBS/VGCS assignment procedure, meaning that the already allocated terrestrial resource of the new cell is used.
NOTE 8:	This element is included at least when the message is sent as a reaction to reception of a HANDOVER REQUIRED message containing a "Current channel type 1" information element. In this case it shall be equal to the received element.
NOTE 9:	This information element should always be included. Its cause value should be the same as indicated in the corresponding Handover Required message.
NOTE 10:	This element is included at least when the message is sent as a reaction to reception of a HANDOVER REQUIRED message containing a "Speech version (used)" information element. In this case it shall be equal to the received element.
NOTE 11:	This information element is included for voice group call, when this is included it indicates that the mobile is a talker in the call else the mobile is a listener.
NOTE 12:	The information is indicated by the MSC if known
NOTE 13:	This element is included if and only if the message is sent as a reaction to the reception of a HANDOVER REQUIRED message or a RELOCATION REQUIRED message (see 3GPP TS 25.413) or an SRVCC PS to CS REQUEST message (see 3GPP TS 29.280) containing an "old BSS to new BSS information" information element. Its contents shall be equal to the received element.
NOTE 14:	This information element is included when the subscriber has localised service area support.
NOTE 15:	This information element is included if LSA access control function shall be suppressed in the BSS.
NOTE 16:	This information element is included at least when the MS is dual transfer mode capable and the IMSI is available at the MSC.
NOTE 17:	If intersystem handover from GSM to UMTS or to cdma 2000 is performed, this information element indicates the target RNC-ID (or Extended RNC-ID).
NOTE 18:	This information element shall be included when intersystem handover (UMTS) is performed. This element is included if and only if the message is sent as a reaction to the reception of a HANDOVER REQUIRED message containing an "Source RNC to Target RNC transparent information (UMTS)" IE. Its contents shall be equal to the received element. Only provided in the HANDOVER REQUEST message on the MAP-E interface.
NOTE 19:	This information element shall be included when intersystem handover (cdma2000) is performed. This element is included if and only if the message is sent as a reaction to the reception of a HANDOVER REQUIRED message containing a "Source RNC to Target RNC transparent information (cdma2000)" IE. Its contents shall be equal to the received element. Only provided in the HANDOVER REQUEST message on the MAP-E interface.
NOTE 20:	In intersystem handover from UMTS (or cdma2000) to GSM this IE indicates the serving area of the UE. In case of intersystem handover from EPS to GSM (SRVCC), this IE indicates that the source is E-UTRAN (see 3GPP TS 23.216).
NOTE 21:	This information element is included if a preference for other radio access technologies shall be applied to the MS connection.
NOTE 22:	This information element may be included to provide UE's SNA Access Information. This IE is provided in the HANDOVER REQUEST message only on the MAP-E interface. SNA Access Information is included in HANDOVER REQUEST message if HANDOVER REQUEST message including SNA Access Information does not exceed the maximum length defined for BSSMAP message.
NOTE 23:	This information element is included for a talker in a voice group call, if the network supports talker priority and uplink access option (i) (as defined in 3GPP TS 43.068) and A-interface link sharing.
NOTE 24:	These IEs are not included, if the Channel Type IE indicates "signalling". The Circuit Identity Code may be included, if at least one alternative for a TDM connection is included in Codec List (MSC Preferred). The AoIP Transport Layer Address (MGW) and Call Identifier may be included, if at least one alternative for an IP connection is included in Codec List (MSC Preferred). The HANDOVER REQUEST message may include both, a Circuit Identity Code and an AoIP Transport Layer Address (MGW) simultaneously. If the Codec List (MSC Preferred) is included in Handover Request, then the BSS shall not allocate a Circuit Identity Code on its own. For HANDOVER REQUEST messages sent on the A-Interface, at least one of Circuit Identity Code or AoIP Transport Layer Address (MGW) plus Call Identifier shall be included (except if the Channel Type IE indicates "signalling")(the same requirement does not apply for HANDOVER REQUEST messages sent on the MAP/E interface)
NOTE 25:	This IE is not included, if the Channel Type IE indicates "signalling". Codec List (MSC Preferred) shall be included if the core network supports an IP based user plane interface. The information in Codec List (MSC Preferred) shall be consistent with the information in Channel

	Type and with the information in Speech Version (Used), if included.
NOTE 26:	Void
NOTE 27:	This IE is included if the encryption algorithm A5/4 is indicated as permitted in the Encryption Information IE.
NOTE 28:	This IE is included if local switching is requested by the MSC.

Typical Cause values are:

- uplink quality;
- uplink strength;
- downlink quality;
- downlink strength;
- distance;
- better cell;
- response to MSC invocation;
- O and M intervention;
- directed retry;
- switch circuit pool;
- traffic;
- preemption;
- reduce load in serving cell.

### 3.2.1.9 HANDOVER REQUIRED

This message is sent from the BSS to the MSC to indicate that for a given MS which already has dedicated radio resource(s) assigned, a handover is required for the reason given by the cause element.

The message is sent via the BSSAP SCCP connection associated with the dedicated resource(s).

INFORMATION ELEMENT	REFERENCE	DIRECTION	TYPE	LEN
Message Type	3.2.2.1	BSS-MSC	M	1
Cause	3.2.2.5	BSS-MSC	M	3-4
Response Request	3.2.2.28	BSS-MSC	O (note 8)	1
Cell Identifier List (Preferred)	3.2.2.27	BSS-MSC	M (note 4)	2n+3 to 7n+3
Circuit Pool List	3.2.2.46	BSS-MSC	O (note 1)	V
Current Channel Type 1	3.2.2.49	BSS-MSC	O (note 2)	2
Speech Version (Used)	3.2.2.51	BSS-MSC	O (note 3)	2
Queueing Indicator	3.2.2.50	BSS-MSC	O	2
Old BSS to New BSS Information	3.2.2.58	BSS-MSC	O	2-n
Source RNC to target RNC transparent information (UMTS)	3.2.2.76	BSS-MSC	O (note 5)	3-m
Source RNC to target RNC transparent information (cdma2000)	3.2.2.77	BSS-MSC	O (note 6)	n-m
GERAN Classmark	3.2.2.78	BSS-MSC	O (note 7)	V
Talker Priority	3.2.2.89	BSS-MSC	O (note 9)	2
Speech Codec (Used)	3.2.2.104	BSS-MSC	O (note 10)	3-5
CSG Identifier	3.2.2.110	BSS-MSC	O (note 11)	7
NOTE 1: Shall be included when the cause is "switch circuit pool" and the MSC allocates the A interface circuit.				
NOTE 2: This information element should always be included.				
NOTE 3: This information element should always be included when the channel mode is speech, and only in this case.				
NOTE 4: If intersystem handover from GSM to UMTS or to cdma2000 is performed, this information element indicates the target. Only one RNC identity is included for Intersystem Handover to UTRAN or to cdma2000.				
NOTE 5: This information element shall be included when intersystem handover (UMTS) is performed. Source RNC to target RNC transparent information is a general container to carry Inter RAT Handover Info (UTRAN specific information) and Inter RAT UE radio access capability (Classmark Information Type 2 and Classmark Information Type 3) from BSS to RNC. The Inter RAT Handover Info and the Inter RAT UE radio access capability is conveyed in the RRC container INTER RAT HANDOVER INFO WITH INTER RAT CAPABILITIES as defined in 3GPP TS 25.331.				
NOTE 6: This information element shall be included when intersystem handover (cdma2000) is performed. Source RNC to target RNC transparent information is a general container to carry cdma2000 specific information from BSS to RNC.				
NOTE 7: This information element may be included when handover of CS services from GERAN A/Gb mode to GERAN Iu mode is performed (see sub-clause 3.1.5a.1).				
NOTE 8: This information element shall be included in the case of DTM Handover.				
NOTE 9: This information element is included for a talker or a new subscriber requesting the uplink in a voice group call, if the network supports talker priority and uplink access option (i) (as defined in 3GPP TS 43.068) and A-interface link sharing.				
NOTE 10: Speech Codec (Used) shall be included if the radio access network supports an IP based user plane interface. This information element shall be consistent with the information in "Current Channel Type 1", if included, and with the information in Speech Version (Used), if included.				
NOTE 11: This information element shall be included when the target cell is a CSG cell or a Hybrid cell.				

Typical Cause values are:

- uplink quality;
- uplink strength;

- downlink quality;
- downlink strength;
- distance;
- better cell;
- response to MSC invocation;
- O&M intervention;
- directed retry;
- switch circuit pool;
- traffic;
- preemption;
- reduce load in serving cell.

#### 3.2.1.10 HANDOVER REQUEST ACKNOWLEDGE

This message is sent from the BSS to the MSC and indicates that the request to support a handover at the target BSS can be supported by the BSS, and also to which radio channel(s) the MS should be directed.

The message is sent via the BSSAP SCCP connection associated with the dedicated resource.

INFORMATION ELEMENT	REFERENCE	DIRECTION	TYPE	LEN
Message Type	3.2.2.1	BSS-MSC	M	1
Layer 3 Information	3.2.2.24	BSS-MSC	M (note 1)	11-n
Chosen Channel	3.2.2.33	BSS-MSC	O (note 4)	2
Chosen Encryption Algorithm	3.2.2.44	BSS-MSC	O (note 5)	2
Circuit Pool	3.2.2.45	BSS-MSC	O (note 2)	2
Speech Version (Chosen)	3.2.2.51	BSS-MSC	O (note 6)	2
Circuit Identity Code	3.2.2.2	BSS-MSC	O (note 3)	3
LSA Identifier	3.2.2.15	BSS-MSC	O (note 7)	5
New BSS to Old BSS Information	3.2.2.80	BSS-MSC	O (note 8)	2-n
Inter-System Information	3.2.2.81	BSS-MSC	O (note 9)	2-n
Talker Priority	3.2.2.89	BSS-MSC	O (note 10)	2
AoIP Transport Layer Address (BSS)	3.2.2.102	BSS-MSC	O (note 11)	8-20
Codec List (BSS Supported)	3.2.2.103	BSS-MSC	O (note 12)	3-n
Speech Codec (Chosen)	3.2.2.104	BSS-MSC	O (note 12)	3-5
LCLS-BSS-Status	3.2.2.119	BSS-MSC	O (note 13)	2

NOTE 1: This information element carries a radio interface message. In the case of an Intersystem handover to UMTS this information element contains (on MAP-E interface) a HANOVER TO UTRAN COMMAND message as defined in 3GPP TS 25.331. In the case of an Inter BSC handover or in the case of an Intersystem Handover from UTRAN to GSM or in the case of an Intersystem Handover from EPS to GSM (SRVCC), it contains a HANOVER COMMAND message as defined in 3GPP TS 44.018. In the case of an Intersystem Handover from cdma2000, it contains a HANOVER COMMAND message as defined in 3GPP TS 44.018. In the case of an Intersystem handover to cdma2000, this information element contains (on MAP-E interface) the HANOVER TO CDMA2000 COMMAND message, as defined in 3GPP TS 44.018.

NOTE 2: Shall be included when several circuit pools are present on the BSS MSC interface and a circuit was allocated by the HANOVER REQUEST message.

NOTE 3: The Circuit identity code information element is included mandatorily by the BSS if the BSS allocates the A interface circuits and a circuit is needed. If the Codec List (MSC Preferred) was included in Handover Request, then the BSS shall not allocate a Circuit Identity Code on its own.

NOTE 4: Included at least when the channel rate/type choice was done by the BSS.

NOTE 5: Included at least when the encryption algorithm has been selected by the BSS.

NOTE 6: Included at least when the speech version choice was done by the BSS.

NOTE 7: Shall be included if a potential current LSA in the target cell has been identified (see 3GPP TS 43.073). Not included means that there is no potential current LSA in the target cell.

NOTE 8: In the case of an external handover, this information element may be included by the target BSS when traffic load information of the target cell is to be sent to the source BSS.

NOTE 9: In the case of an inter-system handover from UTRAN or from cdma2000 to GSM, this information element may be included by the target BSS when traffic load information of the target cell is to be sent to the source system.

NOTE 10: This information element is included for a talker in a voice group call, if the network supports talker priority and uplink access option (i) (as defined in 3GPP TS 43.068) and A-interface link sharing.

NOTE 11: AoIP Transport Layer Address (BSS) shall be included if and only if the BSS has chosen an IP connection for the user plane interface. Included is the IP Transport Layer information of the BSS.

NOTE 12: Codec List (BSS Supported) and Speech Codec (Chosen) shall be included if the radio access network supports an IP based user plane interface. The information in Codec List (BSS Supported) and the information in Speech Codec (Chosen) shall be consistent with the information in Chosen Channel, if included, and with the information in Speech Version (Chosen), if included.

NOTE 13: This IE shall be included if LCLS is supported by BSS and Global Call Reference IE, LCLS-Configuration IE and LCLS-Connection-Status-Control IE were included in the HANOVER REQUEST message.



### 3.2.1.11 HANDOVER COMMAND

This message is sent from the MSC to the BSS via the relevant SCCP connection and contains the target channel to which the MS should retune.

INFORMATION ELEMENT	REFERENCE	DIRECTION	TYPE	LEN
Message Type	3.2.2.1	MSC-BSS	M	1
Layer 3 Information	3.2.2.24	MSC-BSS	M (note 1)	11-n
Cell Identifier	3.2.2.17	MSC-BSS	O	3-10
New BSS to Old BSS Information	3.2.2.80	MSC-BSS	O (note 2)	2-n
Talker Priority	3.2.2.89	MSC-BSS	O (note 3)	2
<p>NOTE 1: This information element carries a radio interface message. In the case of an Intersystem handover to UMTS, this information element contains a HANDOVER TO UTRAN COMMAND message as defined in 3GPP TS 25.331. In the case of an Inter BSC handover, it contains an RR HANDOVER COMMAND message as defined in 3GPP TS 44.018. In the case of an Intersystem handover to cdma2000, this information element contains the HANDOVER TO CDMA2000 COMMAND message, as defined in 3GPP TS 44.018.</p> <p>NOTE 2: This information element may be included if received from the target BSS or the target system. Its contents shall be equal to the received element.</p> <p>NOTE 3: This information element is included for a talker or a new subscriber requesting the uplink in a voice group call, if the network supports talker priority and uplink access option (i) (as defined in 3GPP TS 43.068) and A-interface link sharing.</p>				

### 3.2.1.12 HANDOVER COMPLETE

This message is sent from the BSS to the MSC via the relevant SCCP connection. It is used in the Inter-BSS Handover Execution procedure and the Internal Handover Execution procedure with different contents in these two cases.

It indicates that the correct MS has successfully accessed the target cell.

INFORMATION ELEMENT	REFERENCE	DIRECTION	TYPE	LEN
Message Type	3.2.2.1	BSS-MSC	M	1
RR Cause	3.2.2.22	BSS-MSC	O	2
Talker Priority	3.2.2.89	BSS-MSC	O (note 1)	2
Speech Codec (Chosen)	3.2.2.104	BSS-MSC	O (note 2)	3-5
Codec List (BSS Supported)	3.2.2.103	BSS-MSC	O (note 3)	3-n
Chosen Encryption Algorithm	3.2.2.44	BSS-MSC	O (note 4)	2
Chosen Channel	3.2.2.33	BSS-MSC	O (note 5)	2
LCLS-BSS-Status	3.2.2.119	BSS-MSC	O (note 6)	2
<p>NOTE 1: "Talker Priority" is included for a talker in a voice group call, if the network supports talker priority and uplink access option (i) (as defined in 3GPP TS 43.068) and A-interface link sharing in case of the Inter-BSS Handover procedure.</p> <p>NOTE 2: "Speech Codec (Chosen)" shall be included in case of the Internal Handover Execution procedure.</p> <p>NOTE 3: "Codec List (BSS Supported)" may be included in case of the Internal Handover Execution procedure.</p> <p>NOTE 4: "Chosen Encryption Algorithm" shall be included in case of the Internal Handover Execution procedure, if the encryption algorithm has been changed by the BSS.</p> <p>NOTE 5: "Chosen Channel" shall be included in case of the Internal Handover Execution procedure, if the channel count or the bit rate has changed for a CS data call.</p> <p>NOTE 6: This IE shall be included if LCLS is supported by BSS and if local switching was previously requested for this call leg by the MSC.</p>				

### 3.2.1.13 HANDOVER SUCCEEDED

This message is sent from the MSC to the old BSS via the relevant SCCP connection.

It indicates that the correct MS has successfully accessed the target cell.

INFORMATION ELEMENT	REFERENCE	DIRECTION	TYPE	LEN
Message Type	3.2.2.1	MSC-BSS	M	1
Talker Priority	3.2.2.89	MSC-BSS	O (note 1)	2
NOTE 1: This information element is included for a talker in a voice group call, if the network supports talker priority and uplink access option (i) (as defined in 3GPP TS 43.068) and A-interface link sharing.				

### 3.2.1.14 HANDOVER CANDIDATE ENQUIRE

This message is sent from the MSC to the BSS, using the connectionless services of the SCCP.

INFORMATION ELEMENT	REFERENCE	DIRECTION	TYPE	LEN
Message Type	3.2.2.1	MSC-BSS	M	1
Number Of Mss	3.2.2.8	MSC-BSS	M	2
Cell Identifier List	3.2.2.27	MSC-BSS	M	2n+3 to 7n+3
Cell Identifier	3.2.2.17	MSC-BSS	M	3-10

### 3.2.1.15 HANDOVER CANDIDATE RESPONSE

This message is sent from the BSS to the MSC in response to receipt of a HANDOVER CANDIDATE ENQUIRE message. It contains the number of MSs for which HANDOVER REQUIRED messages have been sent.

This message is sent as a connectionless SCCP message.

INFORMATION ELEMENT	REFERENCE	DIRECTION	TYPE	LEN
Message Type	3.2.2.1	BSS-MSC	M	1
Number Of Mss	3.2.2.8	BSS-MSC	M	2
Cell Identifier	3.2.2.17	BSS-MSC	M	3-10

### 3.2.1.16 HANDOVER FAILURE

This message is sent from the BSS to the MSC via the relevant SCCP connection. It indicates to the MSC that there has been a failure in the resource allocation process on handover, and that the handover has been aborted.

INFORMATION ELEMENT	REFERENCE	DIRECTION	TYPE	LEN
Message Type	3.2.2.1	BSS-MSC	M	1
Cause	3.2.2.5	BSS-MSC	M	3-4
RR Cause	3.2.2.22	BSS-MSC	O	2
Circuit Pool	3.2.2.45	BSS-MSC	O (note 1)	2
Circuit Pool List	3.2.2.46	BSS-MSC	O (note 2)	V
GERAN Classmark	3.2.2.78	BSS-MSC	O (note 3)	V
New BSS to Old BSS Information	3.2.2.80	BSS-MSC	O (note 4)	2-n
Inter-System Information	3.2.2.81	BSS-MSC	O (note 5)	2-n
Talker Priority	3.2.2.89	BSS-MSC	O (note 6)	2
Codec List (BSS Supported)	3.2.2.103	BSS-MSC	O (note 7)	3-n
<p>NOTE 1: Shall be included when several circuit pools are present on the BSS MSC interface.</p> <p>NOTE 2: May be included when cause is "circuit pool mismatch" or "switch circuit pool" to indicate circuit pool preferences.</p> <p>NOTE 3: May be included in case of inter-system handover to GERAN lu-mode via the E interface, if the "GERAN Classmark" IE was provided by the target BSC (see 3GPP TS 43.051).</p> <p>NOTE 4: In the case of an external handover, this information element may be included by the target BSS when traffic load information of the target cell is to be sent to the source BSS.</p> <p>NOTE 5: In the case of an inter-system handover from UTRAN or cdma2000 to GSM, this information element may be included by the target BSS when traffic load information of the target cell is to be sent to the source system.</p> <p>NOTE 6: This information element is included for a talker in a voice group call, if the network supports talker priority and uplink access option (i) (as defined in 3GPP TS 43.068) and A-interface link sharing.</p> <p>NOTE 7: This information element may be included if the radio access network supports an IP based user plane interface.</p>				

Typical Cause values are:

- radio interface message failure;
- O and M intervention;
- Equipment failure;
- no radio resource available;
- requested terrestrial resource unavailable;
- requested transcoding/rate adaption unavailable;
- terrestrial resource already allocated;
- Call Identifier already allocated;
- invalid message contents;
- radio interface failure - reversion to old channel;
- ciphering algorithm not supported;
- circuit pool mismatch;
- switch circuit pool;
- requested speech version unavailable;
- traffic load in the target cell higher than in the source cell;
- incoming relocation not supported due to PUESBINE feature (This cause value is only sent by 3G\_MSC-B over the MAP/E interface);

Requested A-Interface Type not supported;

Requested Codec Type or Codec Configuration not supported;

- Requested Codec Type or Codec Configuration unavailable;
- Requested A-Interface Type unavailable;
- Requested Redundancy Level not supported;
- Requested Redundancy Level not available;
- INTERNAL HANDOVER ENQUIRY reject.

### 3.2.1.17 RESOURCE REQUEST

This message is sent from the MSC to the BSS and requests the current spare and optionally the total accessible resource on a particular cell.

This message is sent as a connectionless SCCP message.

INFORMATION ELEMENT	REFERENCE	DIRECTION	TYPE	LEN
Message Type	3.2.2.1	MSC-BSS	M	1
Periodicity	3.2.2.12	MSC-BSS	M	2
Resource Indication Method	3.2.2.29	MSC-BSS	M	2
Cell Identifier	3.2.2.17	MSC-BSS	M	3-10
Extended Resource Indicator	3.2.2.13	MSC-BSS	O	2

### 3.2.1.18 RESOURCE INDICATION

This message is sent from the BSS to the MSC in response to a resource request message, the message includes an explicit indication of the cell concerned.

This message is sent as a connectionless SCCP message.

INFORMATION ELEMENT	REFERENCE	DIRECTION	TYPE	LEN
Message Type	3.2.2.1	BSS-MSC	M	1
Resource Indication Method	3.2.2.29	BSS-MSC	M	2
Resource Available	3.2.2.4	BSS-MSC	O (note 1)	21
Cell Identifier	3.2.2.17	BSS-MSC	M	3-10
Total Resource Accessible	3.2.2.14	BSS-MSC	O (note 2)	5
NOTE 1: This element is not included if the message is sent only as an acknowledgement to the reception of a RESOURCE REQUEST message.				
NOTE 2: This element has to be included if requested by the Extended Resource Indicator, except when the message is sent only as an acknowledgement to the reception of the RESOURCE REQUEST message.				

### 3.2.1.19 PAGING

This message is sent from the MSC to the BSS and contains sufficient information to allow the paging message to be transmitted by the correct cells at the correct time.

This message is sent as a connectionless SCCP message.

INFORMATION ELEMENT	REFERENCE	DIRECTION	TYPE	LEN
Message Type	3.2.2.1	MSC-BSS	M	1
IMSI	3.2.2.6	MSC-BSS	M	3-10
TMSI	3.2.2.7	MSC-BSS	O (note 1)	6
Cell Identifier List	3.2.2.27	MSC-BSS	M	3 to 3+7n
Channel Needed	3.2.2.36	MSC-BSS	O (note 2)	2
eMLPP Priority	3.2.2.56	MSC-BSS	O (note 3)	2
Paging Information	3.2.2.85	MSC-BSS	O	2
NOTE 1: This element is omitted in the exceptional case where the IMSI is used instead of the TMSI as a paging address at the radio interface.				
NOTE 2: If the channel needed element is not present, the default value is assumed to be 00 (any channel).				
NOTE 3: If the BSS implements the eMLPP feature it should use this information element to build the radio interface Paging request messages, otherwise the information may be considered as an unrecognisable information element.				

### 3.2.1.20 CLEAR REQUEST

This message is sent from the BSS to the MSC to indicate to the MSC that the BSS wishes to release the associated dedicated resource(s).

The message is sent via the BSSAP SCCP connection associated with the dedicated resource(s).

INFORMATION ELEMENT	REFERENCE	DIRECTION	TYPE	LEN
Message Type	3.2.2.1	BSS-MSC	M	1
Cause	3.2.2.5	BSS-MSC	M	3-4

Typical Cause values are:

- radio interface message failure;
- O and M intervention;
- equipment failure;
- Joined group call channel;
- protocol error between BSS and MSC;
- preemption;
- access restricted due to shared networks.

### 3.2.1.21 CLEAR COMMAND

This message is sent from the MSC to the BSS to instruct the BSS to release the associated dedicated resource(s).

The message is sent via the BSSAP SCCP connection associated with the dedicated resource(s).

This message is also sent from the MSC to the BSS to instruct the BSS to release the VGCS/VBS call controlling resources. In this case the message is sent via the VGCS/VBS call controlling SCCP connection.

INFORMATION ELEMENT	REFERENCE	DIRECTION	TYPE	LEN
Message Type	3.2.2.1	MSC-BSS	M	1
Layer 3 Header Information	3.2.2.9	MSC-BSS	O (note)	4
Cause	3.2.2.5	MSC-BSS	M	3-4
CSFB Indication	3.2.2.121	MSC-BSS	O	1
NOTE:	This information element doesn't serve any useful purpose. MSCs should not send the information element unless it is required by the recipients (due to the need to interwork with older versions of the protocol). It is expected that in future versions of the present document, this information element will be deleted from this message.			

Typical Cause values are:

- call control;
- O and M intervention;
- equipment failure;
- requested terrestrial resource unavailable;
- handover successful;
- protocol error between BSS and MSC.

### 3.2.1.22 CLEAR COMPLETE

This message is sent from the BSS to the MSC to inform the MSC that the associated dedicated resource(s) has been successfully cleared.

The message is sent via the BSSAP SCCP connection associated with the dedicated resource(s).

This message is also sent from the BSS to the MSC to inform the MSC that the VGCS/VBS call controlling resources have been successfully cleared. In this case the message is sent via the VGCS/VBS call controlling SCCP connection.

INFORMATION ELEMENT	REFERENCE	DIRECTION	TYPE	LEN
Message Type	3.2.2.1	BSS-MSC	M	1

### 3.2.1.23 RESET

This message can be sent either from the BSS to the MSC or from the MSC to the BSS. It indicates to the receiving entity that the transmitting entity has suffered a failure and has lost memory of the calls in progress, calls set up, and associated references.

This message is sent as a connectionless SCCP message.

INFORMATION ELEMENT	REFERENCE	DIRECTION	TYPE	LEN
Message Type	3.2.2.1	Both	M	1
Cause	3.2.2.5	Both	M	3-4
A-Interface Selector for RESET	3.2.2.107	Both	O	2

The optional A-Interface Selector for RESET IE allows selecting all calls associated to TDM circuits and/or all calls associated to IP links. If the A-Interface Selector for RESET IE is not present in the RESET message, then all calls shall be cleared (TDM and IP).

Typical Cause values are:

- O and M intervention;
- equipment failure.

### 3.2.1.24 RESET ACKNOWLEDGE

This message can be sent either from the BSS to the MSC or from the MSC to the BSS. It indicates to the receiving entity that the transmitting entity has cleared all calls and reset all references, and is ready to resume service.

This message is sent as a connectionless SCCP message.

INFORMATION ELEMENT	REFERENCE	DIRECTION	TYPE	LEN
Message Type	3.2.2.1	Both	M	1
A-Interface Selector for RESET	3.2.2.107	Both	O	2

The optional A-Interface Selector for RESET IE shall be included in RESET ACKNOWLEDGE as received in RESET.

### 3.2.1.25 HANDOVER PERFORMED

This message is sent from the BSS to the MSC in order to indicate that the BSS has performed an internal handover.

The cell identifier and (if required for O and M reasons) optionally the new channel identity is included.

The message is sent via the BSSAP SCCP connection associated with the dedicated resource(s).

INFORMATION ELEMENT	REFERENCE	DIRECTION	TYPE	LEN
Message Type	3.2.2.1	BSS-MSC	M	1
Cause	3.2.2.5	BSS-MSC	M	3-4
Cell Identifier	3.2.2.17	BSS-MSC	M (note 5)	3-10
Chosen Channel	3.2.2.33	BSS-MSC	O (note 1)	2
Chosen Encryption Algorithm	3.2.2.44	BSS-MSC	O (note 2)	2
Speech Version (Chosen)	3.2.2.51	BSS-MSC	O (note 3)	2
LSA Identifier	3.2.2.15	BSS-MSC	O (note 4)	5
Talker Priority	3.2.2.89	BSS-MSC	O (note 6)	2
Codec List (BSS Supported) (serving cell)	3.2.2.103	BSS-MSC	O (note 7)	3-n
Speech Codec (Chosen)	3.2.2.104	BSS-MSC	O (note 8)	3-5
LCLS-BSS-Status	3.2.2.119	BSS-MSC	O (note 9)	2
NOTE 1: Included at least when the channel rate/type has changed during the handover.				
NOTE 2: Included at least when the encryption algorithm has been changed by the BSS.				
NOTE 3: Included at least when the speech version has been changed by the BSS.				
NOTE 4: Shall be included if current LSA in the new serving cell has been identified (see 3GPP TS 43.073). Not included means that there is no current LSA in the new serving cell.				
NOTE 5: When sent from MSC-B over MAP/E interface this information element contains indication of Cell Identifier (e.g. CGI). When sent from 3G_MSC-B over MAP/E interface this information element contains indication of Cell Identifier (e.g. CGI) if the handover target is GSM or indication of either RNC-ID (or Extended RNC-ID) or SAI (if known) if the handover target is UMTS (when indication of relocation complete is received from RNC) or indication of SAI when an indication of location report is received (intra UMTS relocation). Note: RNC-ID (or Extended RNC-ID) or SAI are only provided in the HANDOVER PERFORMED message over the MAP-E interface.				
NOTE 6: This information element is included for a talker or a new subscriber requesting the uplink in a voice group call, if the network supports talker priority and uplink access option (i) (as defined in 3GPP TS 43.068) and A-interface link sharing.				
NOTE 7: Codec List (BSS Supported) (serving cell) may be included, if the radio access network supports an IP based user plane interface. The information in Codec List (BSS Supported) shall be consistent with the information in Chosen Channel, if included, and with the information in Speech Version (Chosen), if included.				
NOTE 8: Speech Codec (Chosen) shall be included, if the radio access network supports an IP based user plane interface and if the speech Codec has been changed by the BSS. The information in Speech Codec (Chosen) shall be consistent with the information in Chosen Channel, if included, and with the information in Speech Version (Chosen), if included.				
NOTE 9: This IE shall be included if LCLS is supported by BSS and if local switching was previously requested for this call leg by the MSC.				

Typical Cause values:

- as for the handover required message, except response to MSC invocation.



### 3.2.1.26 OVERLOAD

This message is sent from the BSS to the MSC or from the MSC to the BSS. When sent from the BSS to the MSC it indicates either processor overload of the whole BSS (cell identifier field not present) or overload of a CCCH downlink in which case the relevant cell is identified.

This message is sent as a connectionless SCCP message.

INFORMATION ELEMENT	REFERENCE	DIRECTION	TYPE	LEN
Message Type	3.2.2.1	Both	M	1
Cause	3.2.2.5	Both	M	3-4
Cell Identifier	3.2.2.17	BSS-MSC	O	3-10

Typical Cause values are:

- Processor overload;
- CCCH overload;
- O&M intervention.

### 3.2.1.27 MSC INVOKE TRACE

This message is sent from the MSC to the BSS in order to start production of a trace record at the BSS.

The message is sent via the BSSAP SCCP connection associated with the dedicated resource(s).

INFORMATION ELEMENT	REFERENCE	DIRECTION	TYPE	LEN
Message Type	3.2.2.1	MSC-BSS	M	1
Trace Type	3.2.2.37	MSC-BSS	M	2
Triggerid	3.2.2.38	MSC-BSS	O	3-22
Trace Reference	3.2.2.39	MSC-BSS	M	3
Transactionid	3.2.2.40	MSC-BSS	O	4
Mobile Identity	3.2.2.41	MSC-BSS	O	3-10
OMCId	3.2.2.42	MSC-BSS	O	3-22

### 3.2.1.28 BSS INVOKE TRACE

This message is sent from the BSS to the MSC in order to start production of a trace record at the MSC and/or from the MSC to BSS to target BSSs after a handover.

The message is sent via the BSSAP SCCP connection associated with the dedicated resource(s).

INFORMATION ELEMENT	REFERENCE	DIRECTION	TYPE	LEN
Message Type	3.2.2.1	Both	M	1
Trace Type	3.2.2.37	Both	M	2
Forward Indicator	3.2.2.43	Both	O	2
Triggerid	3.2.2.38	Both	O	3-22
Trace Reference	3.2.2.39	Both	M	3
TransactionId	3.2.2.40	Both	O	4
OMCId	3.2.2.42	Both	O	3-22

### 3.2.1.29 CLASSMARK UPDATE

This message is sent from the BSS to the MSC or from the MSC to the BSS via the relevant SCCP connection associated with that MS transaction. It updates the classmark parameters for the concerned MS.

INFORMATION ELEMENT	REFERENCE	DIRECTION	TYPE	LEN
Message Type	3.2.2.1	Both	M	1
Classmark Information Type 2	3.2.2.19	Both	M	4-5
Classmark Information Type 3	3.2.2.20	Both	O (note 1)	3-34
Talker Priority	3.2.2.89	Both	O (note 2)	2
NOTE 1: This element shall be included by the BSS if it was received from the MS. It shall be included by the MSC if this information element has previously been received by the MSC.				
NOTE 2: This information element is included for a talker or a new subscriber requesting the uplink in a voice group call, if the network supports talker priority and uplink access option (i) (as defined in 3GPP TS 43.068) and A-interface link sharing.				

### 3.2.1.30 CIPHER MODE COMMAND

This message is sent from the MSC to the BSS via the relevant SCCP connection associated with that MS transaction. It updates the encryption parameters for the concerned MS.

INFORMATION ELEMENT	REFERENCE	DIRECTION	TYPE	LEN
Message Type	3.2.2.1	MSC-BSS	M	1
Layer 3 Header Information	3.2.2.9	MSC-BSS	O (note 1)	4
Encryption Information	3.2.2.10	MSC-BSS	M	3-n
Cipher Response Mode	3.2.2.34	MSC-BSS	O	2
Kc <sub>128</sub>	3.2.2.109	MSC-BSS	C (note 2)	17
NOTE 1: This information element doesn't serve any useful purpose. MSCs should not send the information element unless it is required by the recipients (due to the need to interwork with older versions of the protocol). It is expected that in future versions of the present document, this information element will be deleted from this message.				
NOTE 2: This IE is included if the encryption algorithm A5/4 is indicated as permitted in the Encryption Information IE.				

### 3.2.1.31 CIPHER MODE COMPLETE

This message is sent from the BSS to the MSC via the relevant SCCP connection. It indicates that a successful cipher synchronisation has been achieved across the radio interface.

INFORMATION ELEMENT	REFERENCE	DIRECTION	TYPE	LEN
Message Type	3.2.2.1	BSS-MSC	M	1
Layer 3 Message Contents	3.2.2.35	BSS-MSC	O	2-n
Chosen Encryption Algorithm	3.2.2.44	BSS-MSC	O (note)	2
NOTE: Included at least when the encryption algorithm has been selected by the BSS.				

### 3.2.1.32 COMPLETE LAYER 3 INFORMATION

The message is sent from the BSS to the MSC as described in sub-clause 3.1.16 (on receipt of the initial layer 3 message on a dedicated channel, e.g. PAGING RESPONSE, LOCATION UPDATING REQUEST, CM REESTABLISHMENT REQUEST, CM SERVICE REQUEST, IMSI DETACH, IMMEDIATE SETUP).

The message is sent via the BSSAP SCCP connection established for the associated dedicated resource(s).

INFORMATION ELEMENT	REFERENCE	DIRECTION	TYPE	LEN
Message Type	3.2.2.1	BSS-MSC	M	1
Cell Identifier	3.2.2.17	BSS-MSC	M	3-10
Layer 3 Information	3.2.2.24	BSS-MSC	M	3-n
Chosen Channel	3.2.2.33	BSS-MSC	O (note 1)	2
LSA Identifier List	3.2.2.16	BSS-MSC	O (note 2)	3+3n
PADU	3.2.2.68	BSS-MSC	O (note 3)	3-n
Codec List (BSS Supported)	3.2.2.103	BSS-MSC	O (note 4)	3-n
Redirect Attempt Flag	3.2.2.111	BSS-MSC	O (note 5)	1
Send Sequence Number	3.2.2.113	BSS-MSC	O (note 6)	2
IMSI	3.2.2.6	BSS-MSC	O (note 7)	3-10
NOTE 1: This element is optionally used by the BSS to give the MSC a description of the channel rate/type on which the initial layer 3 message was received.				
NOTE 2: This element shall be included at least when the current cell belongs to one or more LSAs.				
NOTE 3: This element is optionally used by the BSS to provide Location Services related information to MSC.				
NOTE 4: Codec List (BSS Supported) shall be included, if the radio access network supports an IP based user plane interface.				
NOTE 5: This element indicates that the core network should respond with a REROUTE COMMAND or REROUTE COMPLETE message.				
NOTE 6: Send Sequence Number shall be included if received in REROUTE COMMAND				
NOTE 7: IMSI shall be included if received in REROUTE COMMAND				

### 3.2.1.33 QUEUEING INDICATION

This message is sent from the BSS to the MSC in order to indicate a delay in the assignment of the required TCH.

The message is sent via the BSSAP SCCP connection associated with the dedicated resource(s).

INFORMATION ELEMENT	REFERENCE	DIRECTION	TYPE	LEN
Message Type	3.2.2.1	MSC-BSS	M	1

### 3.2.1.34 SAPI "n" REJECT

This message is sent from the BSS to the MSC in order to indicate that a message with a SAPI value other than "0" has been rejected.

The message is sent via the BSSAP SCCP connection associated with the dedicated resource(s).

INFORMATION ELEMENT	REFERENCE	DIRECTION	TYPE	LEN
Message Type	3.2.2.1	BSS-MSC	M	1
DLCI	3.2.2.25	BSS-MSC	M	2
Cause	3.2.2.5	BSS-MSC	M	3-4

Typical Cause values are:

- O&M intervention;
- processor overload;
- BSS not equipped;
- MS not equipped.

3.2.1.35 (void)

3.2.1.36 (void)

### 3.2.1.37 HANDOVER REQUIRED REJECT

This message is sent from the MSC to the BSS via the relevant SCCP connection. It indicates to the BSS that the HANDOVER REQUIRED message has not resulted in handover.

INFORMATION ELEMENT	REFERENCE	DIRECTION	TYPE	LEN
Message Type	3.2.2.1	MSC-BSS	M	1
Cause	3.2.2.5	MSC-BSS	M	3-4
New BSS to Old BSS Information	3.2.2.78	MSC-BSS	O (note 1)	2-n
Talker Priority	3.2.2.89	MSC-BSS	O (note 2)	2
NOTE 1: This information element may be included if received from the target BSS or target system. Its contents shall be equal to the received element.				
NOTE 2: This information element is included for a talker in a voice group call, if the network supports talker priority and uplink access option (i) (as defined in 3GPP TS 43.068) and A-interface link sharing.				

Typical Cause values are:

- equipment failure;
- no radio resource available;
- requested terrestrial resource unavailable;
- invalid message contents;
- requested transcoding/rate adaptation unavailable;
- O and M intervention;
- traffic load in target cell higher than in source cell;
- incoming relocation not supported due to PUESBINE feature.

### 3.2.1.38 RESET CIRCUIT

This message is sent either from the BSS to the MSC or from the MSC to the BSS. It indicates to the receiving entity that the state of the circuit indicated in the message is unknown, due to a failure. This message is not relevant for an IP based user plane interface.

This message is sent as a SCCP connectionless message.

INFORMATION ELEMENT	REFERENCE	DIRECTION	TYPE	LEN
Message Type	3.2.2.1	Both	M	1
Circuit Identity Code	3.2.2.2	Both	M	3
Cause	3.2.2.5	Both	M	3-4

Typical Cause values are:

- for the RESET message.

### 3.2.1.39 RESET CIRCUIT ACKNOWLEDGE

This message is sent either from the BSS to the MSC or from the MSC to the BSS. It indicates to the receiving entity that the transmitting entity has cleared a possible call using the circuit, and is ready to resume service. This message is not relevant for an IP based user plane interface.

This message is sent as a connectionless SCCP message.

INFORMATION ELEMENT	REFERENCE	DIRECTION	TYPE	LEN
Message Type	3.2.2.1	Both	M	1
Circuit Identity	3.2.2.2	Both	M	3

### 3.2.1.40 HANDOVER DETECT

This message is sent from the BSS to the MSC via the relevant SCCP connection. It indicates that the correct MS has successfully accessed the target cell.

INFORMATION ELEMENT	REFERENCE	DIRECTION	TYPE	LEN
Message Type	3.2.2.1	BSS-MSC	M	1
Talker Priority	3.2.2.89	BSS-MSC	O (note 1)	2
NOTE 1: This information element is included for a talker in a voice group call, if the network supports talker priority and uplink access option (i) (as defined in 3GPP TS 43.068) and A-interface link sharing.				

### 3.2.1.41 CIRCUIT GROUP BLOCK

This message is sent from the BSS to the MSC or from the MSC to the BSS to indicate that a set of terrestrial resources (ie some timeslots within a system of 2Mbit PCM multiplex) must be remotely blocked at the circuit master, and cannot therefore be used for traffic. This message is not relevant for an IP based user plane interface.

This message is sent as a connectionless SCCP message.

INFORMATION ELEMENT	REFERENCE	DIRECTION	TYPE	LEN
Message Type	3.2.2.1	Both	M	1
Cause	3.2.2.5	Both	M	3-4
Circuit Identity Code	3.2.2.2	Both	M	3
Circuit Identity Code List	3.2.2.31	Both	M	4-35

Typical Cause values:

- O & M intervention;
- equipment failure.

### 3.2.1.42 CIRCUIT GROUP BLOCKING ACKNOWLEDGE

This message is sent from the MSC to the BSS or from the BSS to the MSC to acknowledge the receipt of an earlier CIRCUIT GROUP BLOCK message, and to indicate that the circuits indicated in the status subfield of the Circuit Identity Code List have been remotely blocked. This message is not relevant for an IP based user plane interface.

This message is sent as a connectionless SCCP message.

INFORMATION ELEMENT	REFERENCE	DIRECTION	TYPE	LEN
Message Type	3.2.2.1	Both	M	1
Circuit Identity Code	3.2.2.2	Both	M	3
Circuit Identity Code List	3.2.2.31	Both	M	4-35

### 3.2.1.43 CIRCUIT GROUP UNBLOCK

This message is sent from the BSS to the MSC or from the MSC to the BSS to indicate that a set of terrestrial resources (ie some timeslots within a system of 2Mbit PCM multiplex) may be returned to service at the circuit master. This message is not relevant for an IP based user plane interface.

This message is sent as a connectionless SCCP message.

INFORMATION ELEMENT	REFERENCE	DIRECTION	TYPE	LEN
Message Type	3.2.2.1	Both	M	1
Circuit Identity Code	3.2.2.2	Both	M	3
Circuit Identity Code List	3.2.2.31	Both	M	4-35

### 3.2.1.44 CIRCUIT GROUP UNBLOCKING ACKNOWLEDGE

This message is sent from the MSC to the BSS or from the BSS to the MSC to acknowledge the receipt of an earlier CIRCUIT GROUP UNBLOCK message, and to indicate that the circuits indicated in the status subfield of the Circuit Identity Code List are remotely unblocked. This message is not relevant for an IP based user plane interface.

This message is sent as a connectionless SCCP message.

INFORMATION ELEMENT	REFERENCE	DIRECTION	TYPE	LEN
Message Type	3.2.2.1	Both	M	1
Circuit Identity Code	3.2.2.2	Both	M	3
Circuit Identity Code List	3.2.2.31	Both	M	4-35

### 3.2.1.45 CONFUSION

This message is sent in either direction in response to a message which cannot be treated correctly for some reason, and for which another failure message cannot substitute. The use of this message may be under operator control.

INFORMATION ELEMENT	REFERENCE	DIRECTION	TYPE	LEN
Message Type	3.2.2.1	Both	M	1
Cause	3.2.2.5	Both	M	3-4
Diagnostics	3.2.2.32	Both	M	4-n

Typical Cause values are:

- invalid message contents;
- information element or field missing;
- incorrect value;
- unknown message type;
- unknown information element;
- protocol error between BSS and MSC; and
- invalid cell.

### 3.2.1.46 CLASSMARK REQUEST

This message is sent from the MSC to the BSS via the relevant SCCP connection associated with that MS transaction. It requests an update of the classmark parameters for the concerned MS.

INFORMATION ELEMENT	REFERENCE	DIRECTION	TYPE	LEN
Message Type	3.2.2.1	MSC-BSS	M	1
Talker Priority	3.2.2.89	MSC-BSS	O (note 1)	2
NOTE 1: This information element is included for a talker or a new subscriber requesting the uplink in a voice group call, if the network supports talker priority and uplink access option (i) (as defined in 3GPP TS 43.068) and A-interface link sharing.				

### 3.2.1.47 UNEQUIPPED CIRCUIT

This message is sent from the BSS to the MSC or vice versa to indicate to the partner entity that it is utilising one or several circuit identity codes which are unknown and which therefore should be locally blocked immediately and taken out of service. This message is not relevant for an IP based user plane interface.

This message is sent as a connectionless SCCP message.

INFORMATION ELEMENT	REFERENCE	DIRECTION	TYPE	LEN
Message Type	3.2.2.1	Both	M	1
Circuit Identity Code	3.2.2.2	Both	M	3
Circuit Identity Code List	3.2.2.31	Both	O	4-35

### 3.2.1.48 CIPHER MODE REJECT

This message is sent from the BSS to the MSC via the relevant SCCP connection associated with that MS transaction. It indicates that the BSS is unable to perform the requested ciphering.

INFORMATION ELEMENT	REFERENCE	DIRECTION	TYPE	LEN
Message Type	3.2.2.1	BSS-MSC	M	1
Cause	3.2.2.5	BSS-MSC	M	3-4

Typical Cause values are:

- Ciphering algorithm not supported;
- Invalid message contents;- relocation triggered (NOTE).

NOTE: This cause value is only sent by 3G\_MSC-B over the MAP/E interface (see 3GPP TS 29.010).

### 3.2.1.49 LOAD INDICATION

The LOAD INDICATION message is sent from the BSS to the MSC and from the MSC to the BSS. It indicates to the receiving entity that the transmitting BSS has detected a load situation in the concerned cell.

This message is sent as a connectionless SCCP message.

INFORMATION ELEMENT	REFERENCE	DIRECTION	TYPE	LEN
Message Type	3.2.2.1	Both	M	1
Time Indication	3.2.2.47	Both	M	2
Cell Identifier	3.2.2.17	Both	M	3-10
Cell Identifier List (Target)	3.2.2.27	Both	M	3 to 3+7n
Resource Situation	3.2.2.48	Both	O (note 1)	4-N
Cause	3.2.2.5	Both	O (note 2)	4-5
NOTE 1: This information element can only be omitted, if the sending BSS wants to stop the whole incoming handover traffic to the indicated cell.				
NOTE 2: Included at least when the reason for sending this message is other than traffic load.				

Typical Cause values:

- O & M intervention;
- Equipment failure;
- No radio resource available;
- Processor overload;
- Traffic load.

### 3.2.1.50 VGCS/VBS SETUP

This message is sent from the MSC to the BSS via the newly created SCCP connection in order to request the BSS to support a VGCS/VBS call.

INFORMATION ELEMENT	REFERENCE	DIRECTION	TYPE	LEN
Message Type	3.2.2.1	MSC-BSS	M	1
Group Call Reference	3.2.2.55	MSC-BSS	M	7
Priority	3.2.2.18	MSC-BSS	O	3
VGCS Feature Flags	3.2.2.88	<b>MSC-BSS</b>	<b>O</b>	<b>3</b>

### 3.2.1.51 VGCS/VBS SETUP ACK

This message is sent from the BSS to the MSC via the newly created SCCP connection in order to confirm that the BSS will support the VGCS/VBS call.

INFORMATION ELEMENT	REFERENCE	DIRECTION	TYPE	LEN
Message Type	3.2.2.1	BSS-MSC	M	1
VGCS Feature Flags	3.2.2.88	BSS-MSC	<b>O(note 1)</b>	<b>3</b>
NOTE 1: This information shall only be included if the VGCS Feature Flags IE was present in the VGCS/VBS SETUP and the BSS supports the IE				

### 3.2.1.52 VGCS/VBS SETUP REFUSE

This message is sent from the BSS to the MSC via the newly created SCCP connection in order to reject the SETUP of the VGCS/VBS call.

INFORMATION ELEMENT	REFERENCE	DIRECTION	TYPE	LEN
Message Type	3.2.2.1	BSS-MSC	M	1
Cause	3.2.2.5	BSS-MSC	M	3-4



### 3.2.1.53 VGCS/VBS ASSIGNMENT REQUEST

This message is sent from the MSC to the BSS via the newly created VGCS/VBS resource controlling SCCP connection in order to request the BSS to assign radio resources in a cell to support a VGCS/VBS call.

INFORMATION ELEMENT	REFERENCE	DIRECTION	TYPE	LEN
Message Type	3.2.2.1	MSC-BSS	M	1
Channel Type	3.2.2.11	MSC-BSS	M (note 2)	5-13
Assignment Requirement	3.2.2.52	MSC-BSS	M	2
Cell Identifier	3.2.2.17	MSC-BSS	M	3-10
Group Call Reference	3.2.2.55	MSC-BSS	M	7
Priority	3.2.2.18	MSC-BSS	O	3
Circuit Identity Code	3.2.2.2	MSC-BSS	O (note 4, 5)	3
Downlink DTX Flag	3.2.2.26	MSC-BSS	O (note 2, 4)	2
Encryption Information	3.2.2.10	MSC-BSS	O	3-n
VSTK_RAND	3.2.2.83	MSC-BSS	O (note 1)	7
VSTK	3.2.2.84	MSC-BSS	O (note 1)	18
Cell Identifier List Segment	3.2.2.27a	MSC-BSS	O (note 3)	4-?
KC <sub>128</sub>	3.2.2.109	MSC-BSS	C (note 6)	17
<p>NOTE 1: This information element is included for ciphered VGCS/VBS calls.</p> <p>NOTE 2: If A-interface circuit sharing is used for a given VGCS/VBS call, the MSC shall include the same value for this information element in each VGCS/VBS ASSIGNMENT REQUEST message sent for this VGCS/VBS call to a specific BSS.</p> <p>NOTE 3: This information element shall be included when A-interface link sharing is used if one or more cells have to be identified by this IE or one or more VGCS/VBS AREA CELL INFO messages is to follow.</p> <p>NOTE 4: This information element shall be included when the MSC allocates the A-interface circuits.</p> <p>NOTE 5: If A-interface circuit sharing is used and the MSC is responsible for allocating A-interface circuits the MSC shall include the same value for this information element in each VGCS/VBS ASSIGNMENT REQUEST sent to a given BSS relating to a given VGCS/VBS call.</p> <p>NOTE 6: This IE is included if the encryption algorithm A5/4 is indicated as permitted in the Encryption Information IE.</p>				

### 3.2.1.54 VGCS/VBS ASSIGNMENT RESULT

The VGCS/VBS ASSIGNMENT RESULT message when received indicates the assignment/deassignment of radio resource for the indicated cell.

The message is sent by the BSS via the BSSAP VGCS/VBS resource controlling SCCP connection associated with the dedicated resource.

INFORMATION ELEMENT	REFERENCE	DIRECTION	TYPE	LEN
Message Type	3.2.2.1	BSS-MSC	M	1
Channel Type	3.2.2.11	BSS-MSC	M (note 3, 4)	5
Cell Identifier	3.2.2.17	BSS-MSC	M	3-10
Chosen Channel	3.2.2.33	BSS-MSC	O (note 2)	2
Circuit Identity Code	3.2.2.2	BSS-MSC	O (note 5)	3
Circuit Pool	3.2.2.45	BSS-MSC	O (note 1)	2
<p>NOTE 1: Shall be included when several circuit pools are present on the BSS-MSC interface and a circuit was allocated by the VGCS/VBS ASSIGNMENT REQUEST message.</p> <p>NOTE 2: Included at least when the channel choice was done by the BSS.</p> <p>NOTE 3: Included even if BSS does not allocate radio resource immediately or de-allocate radio resource following VBS/VGCS uplink reply procedure.</p> <p>NOTE 4: If A-interface circuit sharing is used for a given VGCS/VBS call, the BSS shall include the same Channel Type in each VGCS/VBS ASSIGNMENT RESULT message sent for this VGCS/VBS call.</p> <p>NOTE 5: This information element shall be included by the BSS if the BSS allocates the A-interface circuits. If the BSS is responsible for allocating A-interface circuits and A-interface circuit sharing is used for a given VGCS/VBS call, this information element shall be set to the same value in each VGCS/VBS ASSIGNMENT RESULT message sent for this VGCS/VBS call.</p>				

### 3.2.1.55 VGCS/VBS ASSIGNMENT FAILURE

The VGCS/VBS ASSIGNMENT FAILURE message is sent from the BSS to the MSC via the relevant VGCS/VBS resource controlling SCCP connection. It indicates that there has been a failure in an assignment process at the BSS and that the VGCS/VBS Assignment procedure has been aborted for the concerned cell.

In case of A-interface link sharing this message is only send when the resource for the cell of origin could not be established, if the originating service subscriber is served by the BSC, or if no resource could be established.

INFORMATION ELEMENT	REFERENCE	DIRECTION	TYPE	LEN
Message Type	3.2.2.1	BSS-MSC	M	1
Cause	3.2.2.5	BSS-MSC	M	3-4
Circuit Pool	3.2.2.45	BSS-MSC	O (note 1)	2
Circuit Pool List	3.2.2.46	BSS-MSC	O (note 2)	V
NOTE 1: Shall be included when several circuit pools are present on the BSS-MSC interface.				
NOTE 2: May be included when cause is "circuit pool mismatch" or "switch circuit pool" to indicate circuit pool preferences.				

Typical Cause values are:

- VGCS/VBS call non existent;
- O and M intervention;
- equipment failure;
- no radio resource available;
- requested terrestrial resource unavailable;
- requested transcoding/rate adaptation unavailable;
- terrestrial resource already allocated;
- invalid message contents;
- circuit pool mismatch;
- switch circuit pool;
- ciphering algorithm not supported.

### 3.2.1.56 VGCS/VBS QUEUING INDICATION

The VGCS/VBS QUEUING INDICATION message is sent from the BSS to the MSC via the relevant VGCS/VBS resource controlling SCCP connection. It indicates that there is a delay in the assignment of radio resources for the cell.

INFORMATION ELEMENT	REFERENCE	DIRECTION	TYPE	LEN
Message Type	3.2.2.1	BSS-MSC	M	1

### 3.2.1.57 UPLINK REQUEST

This message is sent from the BSS to the MSC in order to indicate that a mobile has requested to access the uplink of a voice group call channel.

INFORMATION ELEMENT	REFERENCE	DIRECTION	TYPE	LEN
Message Type	3.2.2.1	BSS-MSC	M	1
Talker Priority	3.2.2.89	BSS-MSC	O (note 1)	2
Cell Identifier	3.2.2.17	BSS-MSC	O (note 1)	3-10
Layer 3 Information	3.2.2.24	BSS-MSC	O (note 1,3)	3-n
Mobile Identity	3.2.2.41	BSS-MSC	O (note 1,2)	3-n
NOTE 1: This information is only included if the network supports talker priority.				
NOTE 2: This element is only included when the talker priority request was made on the RACH				
NOTE 3: This element is only included when the talker priority request was made on the group call channel				

### 3.2.1.58 UPLINK REQUEST ACKNOWLEDGE

This message is sent from the MSC to the BSS in order to indicate to the BSS that the uplink allocation of the voice group call channel has been granted by the MSC. The message may also indicate the identity of the current talker

INFORMATION ELEMENT	REFERENCE	DIRECTION	TYPE	LEN
Message Type	3.2.2.1	MSC-BSS	M	1
Talker Priority	3.2.2.89	MSC-BSS	O (note 1)	2
Emergency set indication	3.2.2.90	MSC-BSS	O (note 1)	1
Talker Identity	3.2.2.91	MSC-BSS	O	3-20
NOTE 1: This information is only included if the network supports talker priority.				

### 3.2.1.59 UPLINK REQUEST CONFIRMATION

This message is sent from the BSS to the MSC in order to indicate to the MSC that the uplink of the voice group call channel has been successfully established. The message may also indicate the identity of the current talker.

INFORMATION ELEMENT	REFERENCE	DIRECTION	TYPE	LEN
Message Type	3.2.2.1	BSS-MSC	M	1
Cell Identifier	3.2.2.17	BSS-MSC	M	3-10
Talker Identity	3.2.2.91	BSS-MSC	O	3-20
Layer 3 Information	3.2.2.24	BSS-MSC	M	3-n

### 3.2.1.59a UPLINK APPLICATION DATA

This message is sent from the BSS to the MSC in order to pass to the MSC the layer 3 information which has been transmitted by a talker or listener of a group call.

INFORMATION ELEMENT	REFERENCE	DIRECTION	TYPE	LEN
Message Type	3.2.2.1	BSS-MSC	M	1
Cell Identifier	3.2.2.17	BSS-MSC	M	3-10
Layer 3 Information	3.2.2.24	BSS-MSC	M	3-n
Application Data information	3.2.2.100	BSS-MSC	M	3

### 3.2.1.60 UPLINK RELEASE INDICATION

This message is sent from the BSS to the MSC in order to indicate to the MSC that the uplink of the voice group call has been released.

INFORMATION ELEMENT	REFERENCE	DIRECTION	TYPE	LEN
Message Type	3.2.2.1	BSS-MSC	M	1
Cause	3.2.2.5	BSS-MSC	M	3-4
Talker Priority	3.2.2.89	BSS-MSC	O (note 1)	2
NOTE 1: This information is only included if the network supports talker priority.				

Typical cause values:

- radio interface failure;
- Call control;
- O and M intervention.

### 3.2.1.61 UPLINK REJECT COMMAND

This message is sent from the MSC to the BSS in order to indicate to the BSS that the uplink of the voice group call channel is not available for allocation to mobiles that have requested the use of the uplink. The message may also indicate the identity of the current talker.

INFORMATION ELEMENT	REFERENCE	DIRECTION	TYPE	LEN
Message Type	3.2.2.1	MSC-BSS	M	1
Cause	3.2.2.5	MSC-BSS	M	3-4
Current Talker Priority	3.2.2.89	MSC-BSS	O (note 1)	2
Rejected Talker Priority	3.2.2.89	MSC-BSS	O (note 1)	2
Talker Identity	3.2.2.91	MSC-BSS	O	3-20
NOTE 1: This information is only included if the network supports talker priority. If talker priority is supported then both Current Talker Priority and Rejected Talker Priority shall be included.				

Typical cause values:

- radio interface message failure;
- Call control;
- O and M intervention;
- Requested option not authorised.

### 3.2.1.62 UPLINK RELEASE COMMAND

This message is sent from the MSC to the BSS in order to indicate to the BSS that the uplink of the voice group call channel is available for allocation.

INFORMATION ELEMENT	REFERENCE	DIRECTION	TYPE	LEN
Message Type	3.2.2.1	MSC-BSS	M	1
Cause	3.2.2.5	MSC-BSS	M	3-4

Typical cause values:

- Call control;
- Invalid cell (in case the talker has left the Group Call Area).

### 3.2.1.63 UPLINK SEIZED COMMAND

This message is sent from the MSC to the BSS in order to indicate to the BSS that the uplink of the voice group call channel is no longer available for allocation. The message may also indicate the identity of the current talker.

INFORMATION ELEMENT	REFERENCE	DIRECTION	TYPE	LEN
Message Type	3.2.2.1	MSC-BSS	M	1
Cause	3.2.2.5	MSC-BSS	M	3-4
Talker Priority	3.2.2.89	MSC-BSS	O (note 1)	2
Emergency set indication	3.2.2.90	MSC-BSS	O (note 1)	1
Talker Identity	3.2.2.91	MSC-BSS	O	3-20

NOTE 1: This information is only included if the network supports talker priority.

Typical cause values:

- Call control.

### 3.2.1.64 SUSPEND

The SUSPEND message is sent from the BSS to the MSC on the SCCP connection associated to an MS transaction. It indicates to the receiving entity that the transmitting BSS has detected an overload situation in the corresponding connection.

INFORMATION ELEMENT	REFERENCE	DIRECTION	TYPE	LEN
Message Type	3.2.2.1	BSS-MSC	M	1
DLCI	3.2.2.25	BSS-MSC	M	2

NOTE: The SUSPEND message may be only useful for PDSS1.

### 3.2.1.65 RESUME

The RESUME message is sent from the BSS to the MSC on the SCCP connection associated to an MS transaction. It indicates to the receiving entity that the overload situation in the corresponding connection does no more exist.

INFORMATION ELEMENT	REFERENCE	DIRECTION	TYPE	LEN
Message Type	3.2.2.1	BSS-MSC	M	1
DLCI	3.2.2.25	BSS-MSC	M	2

NOTE: The RESUME message may be only useful for PDSS1.

### 3.2.1.66 CHANGE CIRCUIT

This message is sent from the MSC to the BSS. It requests a change of the circuit allocated to a connection. This message is not relevant for an IP based user plane interface.

This message is sent on the relevant SCCP connection.

INFORMATION ELEMENT	REFERENCE	DIRECTION	TYPE	LEN
Message Type	3.2.2.1	MSC-BSS	M	1
Cause	3.2.2.5	MSC-BSS	M	3-4

Typical Cause values are:

- Requested terrestrial resource unavailable;
- Terrestrial circuit already allocated.

### 3.2.1.67 CHANGE CIRCUIT ACKNOWLEDGE

This message is sent from the BSS to the MSC .It allocates a new circuit. This message is not relevant for an IP based user plane interface.

This message is sent on the relevant SCCP connection.

INFORMATION ELEMENT	REFERENCE	DIRECTION	TYPE	LEN
Message Type	3.2.2.1	BSS-MSC	M	1
Circuit identity	3.2.2.2	BSS-MSC	M	3

### 3.2.1.68 Common ID

This message is sent from the MSC to the BSS in order to inform the BSS of the IMSI associated with this SCCP connection.

This message is sent over the relevant SCCP connection, or, in the SCCP Connection Confirm message.

INFORMATION ELEMENT	REFERENCE	DIRECTION	TYPE	LEN
Message Type	3.2.2.1	MSC-BSS	M	1
IMSI	3.2.2.6	MSC-BSS	M	3-10
SNA Access Information	3.2.2.82	MSC-BSC	O (note)	2+n
NOTE 1: This information element may be included to provide UE's SNA Access Information. This IE is provided in the COMMON ID message only on the MAP-E interface. In association with inter MSC handover, SNA Access Information may be included in COMMON ID message if the SNA Access Information exceeded the remaining octets available in the HANDOVER REQUEST message.				
NOTE 2: Void				

### 3.2.1.69 LSA INFORMATION

This message is sent from the MSC to the BSS via the relevant SCCP connection in order to inform the BSS as to which LSA identities the mobile subscriber has subscription.

INFORMATION ELEMENT	REFERENCE	DIRECTION	TYPE	LEN
Message Type	3.2.2.1	MSC-BSS	M	1
LSA Information	3.2.2.23	MSC-BSS	M	3+4n

## 3.2.1.70 (void)

## 3.2.1.71 PERFORM LOCATION REQUEST

This message is sent from the serving MSC to BSS via the relevant SCCP connection. It indicates to the receiving entity that actions related to Location Services needs to be performed.

INFORMATION ELEMENT	REFERENCE	TYPE	LEN
Message Type	3.2.2.1	M	1
Location Type	3.2.2.63	M	3-n
Cell Identifier	3.2.2.17	O	5-10
Classmark Information Type 3	3.2.2.20	O	3-34
LCS Client Type	3.2.2.67	C (note 3)	3-n
Chosen Channel	3.2.2.33	O	2
LCS Priority	3.2.2.62	O	3-n
LCS QoS	3.2.2.60	C (note 1)	3-n
GPS Assistance Data	3.2.2.70	C (note 2)	3-n
APDU	3.2.2.68	O	3-n
IMSI	3.2.2.6	O (note 4)	5-10
IMEI	3.2.2.86	O (note 4)	10
GANSS Location Type	3.2.2.97	C	3
GANSS Assistance Data	3.2.2.95	C (note 5)	3-n
NOTE 1: The IE is present if location of the target MS is requested.			
NOTE 2: The IE is present if the GPS assistance data is requested.			
NOTE 3: The IE is present if the location type indicates a request for a location estimate and is optional otherwise.			
NOTE 4: The IMSI should be sent preferably if known. The IMEI could be sent if the IMSI is not known, or in addition to the IMSI for the purpose of allowing correlation between the two identities.			
NOTE 5: The IE is present if the GANSS assistance data is requested.			

## 3.2.1.72 PERFORM LOCATION RESPONSE

This message is sent from the serving BSS to the MSC via the relevant SCCP connection in response to the PERFORM LOCATION REQUEST. It contains information related to result of positioning of the target MS.

INFORMATION ELEMENT	REFERENCE	TYPE	LEN
Message Type	3.2.2.1	M	1
Location Estimate	3.2.2.64	C (note 1)	3-n
Positioning Data	3.2.2.65	O	3-n
Deciphering Keys	3.2.2.71	C (note 2)	3-n
LCS Cause	3.2.2.66	C (note 3)	3-n
Velocity Estimate	3.2.2.87	O	3-n
GANSS Positioning Data	3.2.2.96	O	3-n
NOTE 1: The IE is present if location of the target MS was requested and the procedure succeeded.			
NOTE 2: These IEs are present if deciphering key was requested and the procedure succeeded			
NOTE 3: The IE is present if the procedure failed.			

## 3.2.1.73 PERFORM LOCATION ABORT

This message is sent from the serving MSC to BSS via the relevant SCCP connection. It indicates to the receiving entity that actions related to Location Services needs to be aborted.

INFORMATION ELEMENT	REFERENCE	TYPE	LEN
Message Type	3.2.2.1	M	1
LCS Cause	3.2.2.66	M	3-n

### 3.2.1.74 CONNECTIONLESS INFORMATION

This message is sent from the BSS to the MSC or from the MSC to the BSS. The MSC forwards the CONNECTIONLESS INFORMATION message to the BSS as to which cell is indicated in the message. The message is sent as a connectionless SCCP message.

INFORMATION ELEMENT	REFERENCE	DIRECTION	TYPE	LEN
Message Type	3.2.2.1	Both	M	1
Network Element Identity (source)	3.2.2.69	Both	M	3-n
Network Element Identity (target)	3.2.2.69	Both	M	3-n
APDU	3.2.2.68	Both	M	3-n
Segmentation	3.2,2,74	Both	C (note 1)	5
Return Error Request	3.2.2.72	Both	C (note 2)	3-n
Return Error Cause	3.2.2.73	Both	C (note 3)	3-n
NOTE 1: This IE is present if and only if the APDU contains a message segment.				
NOTE 2: The IE is present when the source of a message requests for an error response if the message cannot be delivered to its final destination. If this IE is present, then Return Error Cause shall not be present.				
NOTE 3: The IE is present when an error is indicated that the message was not delivered to its final destination. If this IE is present, then Return Error Request shall not be present. Refer to 3GPP TS 49.031 for cause values				

### 3.2.1.75 CHANNEL MODIFY REQUEST

This message is sent from the BSS to the MSC via the relevant SCCP connection in order to request the MSC to start the assignment procedure for changing the channel configuration according to assignment procedure defined in 3GPP TS 23.172 and 3GPP TS 25.413.

INFORMATION ELEMENT	REFERENCE	DIRECTION	TYPE	LEN
Message Type	3.2.2.1	BSS-MSC	M	1
Cause	3.2.2.5	BSS-MSC	M	3-4

The following cause value is applicable to this message:

- Alternative channel configuration requested.

NOTE: In this version of the protocol this message is supported only on the MAP E-interface in case of network-initiated SCUDIF 3GPP TS 23.172. With all other cause values the anchor MSC may ignore this message.

### 3.2.1.76 EMERGENCY RESET INDICATION

This message is sent from the BSS to the MSC to indicate that the BSS has received a request to reset the Emergency mode.

INFORMATION ELEMENT	REFERENCE	DIRECTION	TYPE	LEN
Message Type	3.2.2.1	BSS-MSC	M	1
Cell Identifier	3.2.2.17	BSS-MSC	O	3-10
Layer 3 Information	3.2.2.24	BSS-MSC	O (note 2)	3-n
Mobile Identity	3.2.2.41	BSS-MSC	O (note 1)	3-n
NOTE 1: This element is only included when the talker priority request was made on the RACH				
NOTE 2: This element is only included when the talker priority request was made on the group call channel				

### 3.2.1.77 EMERGENCY RESET COMMAND

This message is sent from the MSC to the BSS in order to clear the Emergency mode in the BSS.

INFORMATION ELEMENT	REFERENCE	DIRECTION	TYPE	LEN
Message Type	3.2.2.1	MSC-BSS	M	1



### 3.2.1.78 VGCS ADDITIONAL INFORMATION

This message is sent from the MSC to the BSS in order to transfer additional information regarding the identity of the current talker.

INFORMATION ELEMENT	REFERENCE	DIRECTION	TYPE	LEN
Message Type	3.2.2.1	MSC-BSS	M	1
Talker Identity	3.2.2.91	MSC-BSS	M	3-20

### 3.2.1.79 VGCS/VBS AREA CELL INFO

This message is sent from the MSC to the BSS via the VGCS/VBS resource controlling SCCP connection in order to transfer information about additional cells for a given group call that could not be sent in the VGCS/VBS ASSIGNMENT REQUEST or previous VGCS/VBS AREA CELL INFO messages. The VGCS/VBS ASSIGNMENT REQUEST and VGCS/VBS AREA CELL INFO messages are sent one after the other until the complete set of cells of that group call area is transferred to the BSS.

This message is only sent in case of A-interface link sharing.

INFORMATION ELEMENT	REFERENCE	DIRECTION	TYPE	LEN
Message Type	3.2.2.1	MSC-BSS	M	1
Cell Identifier List Segment	3.2.2.27a	MSC-BSS	M	4-?
Assignment Requirement	3.2.2.52	MSC-BSS	O	2

### 3.2.1.80 VGCS/VBS ASSIGNMENT STATUS

The VGCS/VBS ASSIGNMENT STATUS message is sent from the BSS to the MSC via the VGCS/VBS resource controlling SCCP connection in order to indicate to the MSC for each cell belonging to a group call area that is controlled by this SCCP connection, whether the radio resources for the indicated cells have been assigned, not assigned/released or optionally waiting to be established.

In the case of A-interface link sharing, one or more instances of the message are sent after expiry of timer T<sub>ast</sub> if there is a change in the channel allocation for this group call. Timer T<sub>ast</sub> shall be re-started each time it expires until the A-interface link is released. The message shall be sent immediately when the group call is established in all cells for the first time.

In the case of group call re-establishment by the BSS and no A-interface link sharing, the message is sent if there is a change in the channel allocation.

INFORMATION ELEMENT	REFERENCE	DIRECTION	TYPE	LEN
Message Type	3.2.2.1	BSS-MSC	M	1
Cell Identifier List Segment for established cells	3.2.2.27b	BSS-MSC	O (note 1)	3-?
Cell Identifier List Segment for cells to be established	3.2.2.27c	BSS-MSC	O (note 1)	3-?
Cell Identifier List Segment for released cells - no user present	3.2.2.27e	BSS-MSC	O (note 1)	3-?
Cell Identifier List Segment for not established cells - no establishment possible	3.2.2.27f	BSS-MSC	O (note 1)	3-?
VGCS/VBS Cell Status	3.2.2.94	BSS-MSC	O (note 2)	3
NOTE 1: .These elements are only included in case of A-interface link sharing.				
NOTE 2: .This element is only included in case of no A-interface link sharing.				

The different Cell Identifier List IEs shall contain only those cells whose status has changed since the last VGCS/VBS ASSIGNMENT STATUS message (or group of VGCS/VBS ASSIGNMENT STATUS messages) was sent.

The *Cell Identifier List Segment for established cells* IE contains the established cells.

The *Cell Identifier List Segment for cells to be established* IE contains the cells where the call has not been established or has been released. Re-establishment by the BSS is being attempted.

The *Cell Identifier List Segment for released cells - no user present* IE contains the cells in which the call was released because no user responded to the latest uplink access request.

The *Cell Identifier List Segment for not established cells - no establishment possible* IE contains the cells in which the call has not been established or where the call was released and (in either case) no establishment by the BSS is possible.

### 3.2.1.81 VGCS SMS

This message is sent from the MSC to the BSS in order to transfer a short message to the VGCS group call.

INFORMATION ELEMENT	REFERENCE	DIRECTION	TYPE	LEN
Message Type	3.2.2.1	MSC-BSS	M	1
SMS to VGCS	3.2.2.92	MSC-BSS	M	2-250

### 3.2.1.82 NOTIFICATION DATA

This message is sent from the MSC to the BSS in order to transfer Application data to the listeners and the talker of an on-going group call.

INFORMATION ELEMENT	REFERENCE	DIRECTION	TYPE	LEN
Message Type	3.2.2.1	MSC-BSS	M	1
Application Data	3.2.2.98	MSC-BSS	M	11
Data Identity	3.2.2.99	MSC-BSS	M	3
MSISDN	3.2.2.101	MSC-BSS	O	2-12

### 3.2.1.83 INTERNAL HANDOVER REQUIRED

This message may be sent if and only if both the BSS and the MSC support an IP based user plane A-interface.

This message is sent from the BSS to the MSC to indicate that for a given MS, which already has dedicated radio resource(s) assigned, a handover is required to a cell in the same BSS, for the reason given by the cause element.

This message is used when the intra-BSS handover implies a Codec Type or a Codec Configuration or an A-interface Type in the target cell, which is incompatible with the one used in the source cell. The source cell and target cell can be the same cell.

The message is sent via the BSSAP SCCP connection associated with the dedicated resource(s).

INFORMATION ELEMENT	REFERENCE	DIRECTION	TYPE	LEN
Message Type	3.2.2.1	BSS-MSC	M	1
Cause	3.2.2.5	BSS-MSC	M	3-4
Cell Identifier	3.2.2.17	BSS-MSC	M	4-10
AoIP Transport Layer Address (BSS)	3.2.2.102	BSS-MSC	C (Note 1)	8-20
Codec List (BSS Supported)	3.2.2.103	BSS-MSC	M	3-n
NOTE 1: This information elements shall be included only if the support of an IP based user plane interface is indicated in the Codec List (BSS Supported) IE.				

Typical Cause values are:

- uplink quality;
- uplink strength;
- downlink quality;
- downlink strength;
- distance;
- better cell;
- O&M intervention;

- traffic;
- preemption;
- reduce load in serving cell;
- response to an INTERNAL HANDOVER ENQUIRY message;
- Redundancy Level not adequate.

### 3.2.1.84 INTERNAL HANDOVER REQUIRED REJECT

This message may be sent if and only if both the BSS and the MSC support an IP based user plane interface.

This message is sent from the MSC to the BSS via the relevant SCCP connection. It indicates to the BSS that the handover required by the previous INTERNAL HANDOVER REQUIRED message can not be supported, because none of the options indicated in the Codec List (BSS supported) can be fulfilled by the MSC.

The message is sent via the BSSAP SCCP connection associated with the dedicated resource(s).

INFORMATION ELEMENT	REFERENCE	DIRECTION	TYPE	LEN
Message Type	3.2.2.1	MSC-BSS	M	1
Cause	3.2.2.5	MSC-BSS	M	3-4
Codec List (MSC Preferred)	3.2.2.103	MSC-BSS	O	3-n

Typical Cause values are:

- Requested A-Interface Type not supported;
- Requested Codec Type or Codec Configuration not supported;
- Requested A-Interface Type unavailable;
- Requested Codec Type or Codec Configuration unavailable;
- Requested terrestrial resource unavailable;
- Requested Redundancy Level not supported.
- Requested Redundancy Level not available;

### 3.2.1.85 INTERNAL HANDOVER COMMAND

This message may be sent if and only if both the BSS and the MSC support an IP based user plane interface.

This message is sent from the MSC to the BSS.

The message is sent via the BSSAP SCCP connection associated with the dedicated resource(s).

INFORMATION ELEMENT	REFERENCE	DIRECTION	TYPE	LEN
Message Type	3.2.2.1	MSC-BSS	M	1
Speech Codec (MSC Chosen)	3.2.2.104	MSC-BSS	M (note 1)	3-n
Circuit Identity Code	3.2.2.2	MSC-BSS	C (note 2)	3
AoIP Transport Layer Address (MGW)	3.2.2.102	MSC-BSS	C (note 3)	8-20
Call Identifier	3.2.2.105	MSC-BSS	C (note 4)	5
Downlink DTX Flag	3.2.2.26	MSC-BSS	O (note 5)	2
LCLS-Connection-Status-Control	3.2.2.117	MSC-BSS	O (note 6)	2
<p>NOTE 1: "Speech Codec (MSC Chosen)" contains in general only one Codec Type, one Codec Configuration and always only one A-Interface Type (TDM or IP). The exception is for compatible Codecs Types, when more than one compatible Codec Type(s) can be included, with the same or compatible Codec Configuration(s).</p> <p>NOTE 2: Circuit Identity Code shall be included, if and only if the A-Interface Type in Speech Codec (MSC Chosen) is TDM.</p> <p>NOTE 3: AoIP Transport Layer Address (MGW) shall be included, if and only if the A-Interface Type in Speech Codec (MSC Chosen) is IP.</p> <p>NOTE 4: Call Identifier shall be included, if and only if the (new) A-Interface Type in Speech Codec (MSC Chosen) is IP and the old A-Interface Type was not IP.</p> <p>NOTE 5: Downlink DTX Flag may be included in the case of a speech TCH, and only in this case. If not included, this has no impact on the DTX function in the BSS. This element shall be neglected by the BSS, if an IP A-Interface type is finally selected and speech transcoder resources are not allocated within the BSS.</p> <p>NOTE 6: This IE is included if local switching is requested by the MSC and if the MSC has not previously (in another BSSAP message) included this IE with indication to "Connect" this particular call leg.</p>				

### 3.2.1.86 INTERNAL HANDOVER ENQUIRY

This message may be sent if and only if both the BSS and the MSC support an IP based user plane A-interface.

This message is sent from the MSC to the BSS via the relevant SCCP connection to trigger a "BSS Internal Handover" procedure to ensure that the best fit of dedicated resource(s) (Codec Type, Codec Configuration and A-Interface Type indicated in the Speech Codec (MSC Chosen)) are allocated to the ongoing call.

INFORMATION ELEMENT	REFERENCE	DIRECTION	TYPE	LEN
Message Type	3.2.2.1	MSC-BSS	M	1
Speech Codec (MSC Chosen)	3.2.2.104	MSC-BSS	M	3-n

### 3.2.1.87 RESET IP RESOURCE

This message is sent either from the BSS to the MSC or from the MSC to the BSS. It indicates to the receiving entity that the sending entity requests the receiving entity to release resources and references associated to the Call Identifiers included in the Call Identifier List. This message shall only be used for connections using an IP based user plane interface.

This message is sent as a SCCP connectionless message.

INFORMATION ELEMENT	REFERENCE	DIRECTION	TYPE	LEN
Message Type	3.2.2.1	Both	M	1
Cause	3.2.2.5	Both	M	3-4
Call Identifier List	3.2.2.106	Both	M	6-n

Typical Cause values are:

- O & M intervention;
- equipment failure.

### 3.2.1.88 RESET IP RESOURCE ACKNOWLEDGE

This message is sent either from the BSS to the MSC or from the MSC to the BSS. It indicates to the receiving entity that the transmitting entity has released resources and references associated to the Call Identifiers included in the Call Identifier List. This message shall only be used for connections using an IP based user plane interface.

This message is sent as a connectionless SCCP message.

INFORMATION ELEMENT	REFERENCE	DIRECTION	TYPE	LEN
Message Type	3.2.2.1	Both	M	1
Call Identifier List	3.2.2.106	Both	M	6-n

### 3.2.1.89 REROUTE COMMAND

This message is sent from the MSC to the BSS via the relevant SCCP connection in order to request rerouting by the BSC to another CN operator. It is only used in MOCN configuration for network sharing.

INFORMATION ELEMENT	REFERENCE	DIRECTION	TYPE	LEN
Message Type	3.2.2.1	MSC-BSS	M	1
Initial Layer 3 Information	3.2.2.24	MSC-BSS	M (note 1)	3-n
Reroute Reject Cause	3.2.2.112	MSC-BSS	M (note 2)	2
Layer 3 Information	3.2.2.24	MSC-BSS	O (note3)	3-n
Send Sequence Number	3.2.2.113	MSC-BSS	O (note 4)	2
IMSI	3.2.2.6	MSC-BSS	O (note 5)	3-10
NOTE 1: The initial Layer 3 Information received from MS.				
NOTE 2: This IE lists cause values which meaning is defined in [6] with the exception of 'CS/PS domain registration coordination required' that will never be forwarded to the MS.				
NOTE 3: This information element contains a mobility management message (e.g. Location Updating Reject). This information element is not needed when CS/PS coordination is indicated but shall be included in all other cases.				
NOTE 4: Contains the value of the N(SD) as defined in [6].				
NOTE 5: This IE shall be included if available in the MSC.				

### 3.2.1.90 REROUTE COMPLETE

This message is sent from the MSC to the BSS via the relevant SCCP connection in order to indicate that the redirection is completed. It is only used in MOCN configuration for network sharing.

INFORMATION ELEMENT	REFERENCE	DIRECTION	TYPE	LEN
Message Type	3.2.2.1	MSC-BSS	M	1
Reroute complete outcome	3.2.2.114	MSC-BSS	M	2

### 3.2.1.91 LCLS-CONNECT-CONTROL

This message may be sent if and only if both the BSS and the MSC support LCLS.

This message is sent from the MSC to the BSS to request a change of the LCLS connection preference and/or the LCLS connection status for a call leg in the BSS. It is sent for each call leg, associated to the relevant SCCP connection.

INFORMATION ELEMENT	REFERENCE	DIRECTION	TYPE	LEN
Message Type	3.2.2.1	MSC-BSS	M	1
LCLS-Configuration	3.2.2.116	MSC-BSS	O (note1)	2
LCLS-Connection-Status-Control	3.2.2.117	MSC-BSS	O (note1)	2
NOTE 1: At least one of these IE"s shall be present in the message.				

### 3.2.1.92 LCLS-CONNECT-CONTROL-ACK

This message may be sent if and only if both the BSS and the MSC support LCLS.

This message is sent from the BSS to the MSC via the relevant SCCP connection to acknowledge the LCLS-CONNECT-CONTROL message.

INFORMATION ELEMENT	REFERENCE	DIRECTION	TYPE	LEN
Message Type	3.2.2.1	BSS-MSC	M	1
LCLS-BSS-Status	3.2.2.119	BSS-MSC	M	2

### 3.2.1.93 LCLS-NOTIFICATION

This message may be sent if and only if both the BSS and the MSC support LCLS.

This message is sent from the BSS to the MSC via the relevant SCCP connection to inform the MSC about a change in the LCLS connection status for the associated call leg. This message may also be sent as a request to release the locally switched call.

INFORMATION ELEMENT	REFERENCE	DIRECTION	TYPE	LEN
Message Type	3.2.2.1	BSS-MSC	M	1
LCLS-BSS-Status	3.2.2.119	BSS-MSC	O (note 1)	2
LCLS-Break-Request	3.2.2.120	BSS-MSC	O (note 1)	1
NOTE 1: Only one of these IE"s shall be present in the message.				

## 3.2.2 Signalling element coding

### 3.2.2.0 General

This sub-clause contains the coding of the signalling elements used.

The following conventions are assumed for the sequence of transmission of bits and bytes:

- Each bit position is marked as 1 to 8. Bit 1 is the least significant bit and is transmitted first;
- In an element octets are identified by number, octet 1 is transmitted first, then octet 2, etc.

When a field extends over more than one octet, the order of bit values progressively decreases as the octet number increases. The least significant bit of the field is represented by the lowest numbered bit of the highest numbered octet of the field.

- For variable length elements a length indicator is included, this indicates the number of octets following in the element;
- All fields within Information Elements are mandatory unless otherwise specified. The Information Element Identifier shall always be included.

All spare bits are set to 0.

Table 3.2.2.1: Signalling elements used and their coding

Element Identifier Coding	Element name	Reference
0000 0001	Circuit Identity Code	3.2.2.2
0000 0010	Reserved (see note 2)	*
0000 0011	Resource Available	3.2.2.4
0000 0100	Cause	3.2.2.5
0000 0101	Cell Identifier	3.2.2.17
0000 0110	Priority	3.2.2.18
0000 0111	Layer 3 Header Information	3.2.2.9
0000 1000	IMSI	3.2.2.6
0000 1001	TMSI	3.2.2.7
0000 1010	Encryption Information	3.2.2.10
0000 1011	Channel Type	3.2.2.11
0000 1100	Periodicity	3.2.2.12
0000 1101	Extended Resource Indicator	3.2.2.13
0000 1110	Number Of MSs	3.2.2.8
0000 1111	Reserved (see note 2)	*
0001 0000	Reserved (see note 2)	*
0001 0001	Reserved (see note 2)	*
0001 0010	Classmark Information Type 2	3.2.2.19
0001 0011	Classmark Information Type 3	3.2.2.20
0001 0100	Interference Band To Be Used	3.2.2.21
0001 0101	RR Cause	3.2.2.22
0001 0110	Reserved (see note 2)	*
0001 0111	Layer 3 Information	3.2.2.24
0001 1000	DLCI	3.2.2.25
0001 1001	Downlink DTX Flag	3.2.2.26
0001 1010	Cell Identifier List	3.2.2.27
0001 1011	Response Request	3.2.2.28
0001 1100	Resource Indication Method	3.2.2.29
0001 1101	Classmark Information Type 1	3.2.2.30
0001 1110	Circuit Identity Code List	3.2.2.31
0001 1111	Diagnostic	3.2.2.32
0010 0000	Layer 3 Message Contents	3.2.2.35
0010 0001	Chosen Channel	3.2.2.33
0010 0010	Total Resource Accessible	3.2.2.14
0010 0011	Cipher Response Mode	3.2.2.34
0010 0100	Channel Needed	3.2.2.36
0010 0101	Trace Type	3.2.2.37
0010 0110	Triggerid	3.2.2.38
0010 0111	Trace Reference	3.2.2.39
0010 1000	Transactionid	3.2.2.40
0010 1001	Mobile Identity	3.2.2.41
0010 1010	OMCId	3.2.2.42
0010 1011	Forward Indicator	3.2.2.43
0010 1100	Chosen Encryption Algorithm	3.2.2.44
0010 1101	Circuit Pool	3.2.2.45
0010 1110	Circuit Pool List	3.2.2.46
0010 1111	Time Indication	3.2.2.47
0011 0000	Resource Situation	3.2.2.48
0011 0001	Current Channel type 1	3.2.2.49
0011 0010	Queueing Indicator	3.2.2.50
0100 0000	Speech Version	3.2.2.51
0011 0011	Assignment Requirement	3.2.2.52
0011 0101	Talker Flag	3.2.2.54
0011 0110	Connection Release Requested	3.2.2.3
0011 0111	Group Call Reference	3.2.2.55
0011 1000	eMLPP Priority	3.2.2.56
0011 1001	Configuration Evolution Indication	3.2.2.57
0011 1010	Old BSS to New BSS Information	3.2.2.58
0011 1011	LSA Identifier	3.2.2.15
0011 1100	LSA Identifier List	3.2.2.16
0011 1101	LSA Information	3.2.2.23
0011 1110	LCS QoS	3.2.2.60

Element Identifier Coding	Element name	Reference
0011 1111	LSA access control suppression	3.2.2.61
0100 0011	LCS Priority	3.2.2.62
0100 0100	Location Type	3.2.2.63
0100 0101	Location Estimate	3.2.2.64
0100 0110	Positioning Data	3.2.2.65
0100 0111	LCS Cause	3.2.2.66
0100 1000	LCS Client Type	3.2.2.67
0100 1001	APDU	3.2.2.68
0100 1010	Network Element Identity	3.2.2.69
0100 1011	GPS Assistance Data	3.2.2.70
0100 1100	Deciphering Keys	3.2.2.71
0100 1101	Return Error Request	3.2.2.72
0100 1110	Return Error Cause	3.2.2.73
0100 1111	Segmentation	3.2.2.74
0101 0000	Service Handover	3.2.2.75
0101 0001	Source RNC to target RNC transparent information (UMTS)	3.2.2.76
0101 0010	Source RNC to target RNC transparent information (cdma2000)	3.2.2.77
0101 0011	GERAN Classmark	3.2.2.78
0101 0100	GERAN BSC Container	3.2.2.79
0110 0001	New BSS to Old BSS Information	3.2.2.80
0110 0011	Inter-System Information	3.2.2.81
0110 0100	SNA Access Information	3.2.2.82
0110 0101	VSTK_RANDOM Information	3.2.2.83
0110 0110	VSTK Information	3.2.2.84
0110 0111	Paging Information	3.2.2.85
0110 1000	IMEI	3.2.2.86
0101 0101	Velocity Estimate	3.2.2.87
0110 1001	VGCS Feature Flags	3.2.2.88
0110 1010	Talker Priority	3.2.2.89
0110 1011	Emergency Set Indication	3.2.2.90
0110 1100	Talker Identity	3.2.2.91
0110 1101	Cell Identifier List Segment	3.2.2.27a
0110 1110	SMS to VGCS	3.2.2.92
0110 1111	VGCS Talker Mode	3.2.2.93
0111 0000	VGCS/VBS Cell Status	3.2.2.94
0111 0001	Cell Identifier List Segment for established cells	3.2.2.27b
0111 0010	Cell Identifier List Segment for cells to be established	3.2.2.27c
0111 0011	Cell Identifier List Segment for released cells - no user present	3.2.2.27e
0111 0100	Cell Identifier List Segment for not established cells - no establishment possible	3.2.2.27f
0111 0101	GANSS Assistance Data	3.2.2.95
0111 0110	GANSS Positioning Data	3.2.2.96
0111 0111	GANSS Location Type	3.2.2.97
0111 1000	Application Data	3.2.2.98
0111 1001	Data Identity	3.2.2.99
0111 1010	Application Data Information	3.2.2.100
0111 1011	MSISDN	3.2.2.101
0111 1100	AoIP Transport Layer Address	3.2.2.102
0111 1101	Speech Codec List	3.2.2.103
0111 1110	Speech Codec	3.2.2.104
0111 1111	Call Identifier	3.2.2.105
1000 0000	Call Identifier List	3.2.2.106
1000 0001	A-Interface Selector for RESET	3.2.2.107
1000 0010	Reserved	#
1000 0011	KC <sub>128</sub>	3.2.2.109
1000 0100	CSG Identifier	3.2.2.110
1000 0101	Redirect Attempt Flag	3.2.2.111
1000 0110	Reroute Reject Cause	3.2.2.112
1000 0111	Send Sequence Number	3.2.2.113
1000 1000	Reroute complete outcome	3.2.2.114
1000 1001	Global Call Reference	3.2.2.115



Element Identifier Coding	Element name	Reference
1000 1010	LCLS-Configuration	3.2.2.116
1000 1011	LCLS-Connection-Status-Control	3.2.2.117
1000 1100	LCLS-Correlation-Not-Needed	3.2.2.118
1000 1101	LCLS-BSS-Status	3.2.2.119
1000 1110	LCLS-Break-Request	3.2.2.120
1000 1111	CSFB Indication	3.2.2.121
0100 0001	Reserved (see note 3)	#
0100 0010	Reserved (see note 3)	#
NOTE 1: (void)		
NOTE 2: Information Element codes marked as "reserved" are reserved for use by previous versions of this interface specification.		
NOTE 3: Information Element codes marked as "reserved" are reserved for use by ANSI version of this interface specification.		

### 3.2.2.1 Message Type

Message Type uniquely identifies the message being sent. It is a single octet element, mandatory in all messages.

Bit 8 is reserved for future extension of the code set. All unassigned codes are spare.

	<b>8 7 6 5 4 3 2 1</b>	
	0 0 0 0 0 0 0 0	Reserved.
ASSIGNMENT MESSAGES	0 0 0 0 0 0 0 1 0 0 0 0 0 0 1 0 0 0 0 0 0 0 1 1 0 0 0 0 1 0 0 0	ASSIGNMENT REQUEST ASSIGNMENT COMPLETE ASSIGNMENT FAILURE CHANNEL MODIFY REQUEST
HANDOVER MESSAGES	0 0 0 1 0 0 0 0 0 0 0 1 0 0 0 1 0 0 0 1 0 0 1 0 0 0 0 1 0 0 1 1 0 0 0 1 0 1 0 0 0 0 0 1 0 1 0 1 0 0 0 1 0 1 1 0 0 0 0 1 0 1 1 1 0 0 0 1 1 0 0 0 0 0 0 1 1 0 0 1 0 0 0 1 1 0 1 0 0 0 0 1 1 0 1 1 0 1 1 1 0 0 0 0 0 1 1 1 0 0 0 1 0 1 1 1 0 0 1 0 0 1 1 1 0 0 1 1	HANDOVER REQUEST HANDOVER REQUIRED HANDOVER REQUEST ACKNOWLEDGE HANDOVER COMMAND HANDOVER COMPLETE HANDOVER SUCCEEDED HANDOVER FAILURE HANDOVER PERFORMED HANDOVER CANDIDATE ENQUIRE HANDOVER CANDIDATE RESPONSE HANDOVER REQUIRED REJECT HANDOVER DETECT INTERNAL HANDOVER REQUIRED INTERNAL HANDOVER REQUIRED REJECT INTERNAL HANDOVER COMMAND INTERNAL HANDOVER ENQUIRY
RELEASE MESSAGES	0 0 1 0 0 0 0 0 0 0 1 0 0 0 0 1 0 0 1 0 0 0 1 0 0 0 1 0 0 0 1 1 0 0 1 0 0 1 0 0 0 0 1 0 0 1 0 1 0 0 1 0 0 1 1 0 0 0 1 0 0 1 1 1	CLEAR COMMAND CLEAR COMPLETE CLEAR REQUEST RESERVED RESERVED SAPI "N" REJECT CONFUSION
OTHER CONNECTION RELATED MESSAGES	0 0 1 0 1 0 0 0 0 0 1 0 1 0 0 1 0 0 1 0 1 0 1 0 0 0 1 0 1 0 1 1 0 0 1 0 1 1 0 0 0 0 1 0 1 1 0 1 0 0 1 0 1 1 1 0 0 0 1 0 1 1 1 1 0 1 1 1 1 0 0 0 0 1 1 1 1 0 0 1	SUSPEND RESUME Reserved (See note) PERFORM LOCATION REQUEST LSA INFORMATION PERFORM LOCATION RESPONSE PERFORM LOCATION ABORT COMMON ID REROUTE COMMAND REROUTE COMPLETE
GENERAL MESSAGES	0 0 1 1 0 0 0 0 0 0 1 1 0 0 0 1 0 0 1 1 0 0 1 0 0 0 1 1 0 0 1 1 0 0 1 1 0 1 0 0 0 0 1 1 0 1 0 1 0 0 1 1 0 1 1 0 0 0 1 1 0 1 1 1 0 0 1 1 1 0 1 0 0 0 1 1 1 1 0 1 0 0 1 1 1 1 1 0	RESET RESET ACKNOWLEDGE OVERLOAD RESERVED RESET CIRCUIT RESET CIRCUIT ACKNOWLEDGE MSC INVOKE TRACE BSS INVOKE TRACE CONNECTIONLESS INFORMATION RESET IP RESOURCE RESET IP RESOURCE ACKNOWLEDGE
TERRESTRIAL RESOURCE MESSAGES	0 1 0 0 0 0 0 0 0 1 0 0 0 0 0 1 0 1 0 0 0 0 1 0 0 1 0 0 0 0 1 1	BLOCK BLOCKING ACKNOWLEDGE UNBLOCK UNBLOCKING ACKNOWLEDGE

	8 7 6 5 4 3 2 1	
	0 1 0 0 0 1 0 0 0 1 0 0 0 1 0 1 0 1 0 0 0 1 1 0 0 1 0 0 0 1 1 1  0 1 0 0 1 0 0 0 0 1 0 0 1 1 1 0 0 1 0 0 1 1 1 1	CIRCUIT GROUP BLOCK CIRCUIT GROUP BLOCKING ACKNOWLEDGE CIRCUIT GROUP UNBLOCK CIRCUIT GROUP UNBLOCKING ACKNOWLEDGE UNEQUIPPED CIRCUIT CHANGE CIRCUIT CHANGE CIRCUIT ACKNOWLEDGE
RADIO RESOURCE MESSAGES	0 1 0 1 0 0 0 0 0 1 0 1 0 0 0 1 0 1 0 1 0 0 1 0 0 1 0 1 0 0 1 1 0 1 0 1 0 1 0 0 0 1 0 1 0 1 0 1 0 1 0 1 0 1 1 0 0 1 0 1 0 1 1 1 0 1 0 1 1 0 0 0 0 1 0 1 1 0 0 1 0 1 0 1 1 0 1 0	RESOURCE REQUEST RESOURCE INDICATION PAGING CIPHER MODE COMMAND CLASSMARK UPDATE CIPHER MODE COMPLETE QUEUING INDICATION COMPLETE LAYER 3 INFORMATION CLASSMARK REQUEST CIPHER MODE REJECT LOAD INDICATION
VGCS/VBS	0 0 0 0 0 1 0 0 0 0 0 0 0 1 0 1 0 0 0 0 0 1 1 0 0 0 0 0 0 1 1 1 0 0 0 1 1 1 0 0 0 0 0 1 1 1 0 1 0 0 0 1 1 1 1 0 0 0 1 1 1 0 1 1 0 0 1 1 1 1 0 0 0 0 0 1 1 1 1 1 0 0 1 0 0 1 1 1 0 1 0 0 1 0 0 1 0 1 0 0 1 0 1 0 0 1 0 0 1 0 1 1 0 1 0 0 1 1 0 0 0 1 0 0 1 1 0 1 0 1 1 0 0 0 0 0 0 1 1 0 0 0 0 1	VGCS/VBS SETUP VGCS/VBS SETUP ACK VGCS/VBS SETUP REFUSE VGCS/VBS ASSIGNMENT REQUEST VGCS/VBS ASSIGNMENT RESULT VGCS/VBS ASSIGNMENT FAILURE VGCS/VBS QUEUING INDICATION VGCS/VBS ASSIGNMENT STATUS VGCS/VBS AREA CELL INFO UPLINK REQUEST UPLINK REQUEST ACKNOWLEDGE UPLINK REQUEST CONFIRMATION UPLINK RELEASE INDICATION UPLINK REJECT COMMAND UPLINK RELEASE COMMAND UPLINK SEIZED COMMAND VGCS ADDITIONAL INFORMATION VGCS SMS
	0 1 1 0 0 0 1 0 0 1 1 0 0 0 1 1	NOTIFICATION DATA UPLINK APPLICATION DATA
LOCAL SWITCHING	0 1 1 1 0 1 0 0 0 1 1 1 0 1 0 1 0 1 1 1 0 1 1 0	LCLS-CONNECT-CONTROL LCLS-CONNECT-CONTROL-ACK LCLS-NOTIFICATION
NOTE: This value was allocated in an earlier phase of the protocol and shall not be used in the future.		

### 3.2.2.2 Circuit Identity Code

This element defines the terrestrial channel over which the call will pass.

If a 2 048 kbits/s digital path is used then the circuit identification code contains in the five least significant bits a binary representation of the actual number of the timeslot which is assigned to the circuit. The remaining bits in the CIC are used where necessary to identify one among several systems interconnecting an originating and destination point.

The element is 2 octets in length:

8	7	6	5	4	3	2	1	
Element identifier								octet 1
a	b	c	d	e	f	g	h	octet 2
i	j	k	X	X	X	X	X	octet 3

a-k defines the PCM multiplex in use.

XXXXXX define the actual timeslot in use.

The circuit identity code defines the PCM multiplex and timeslot in use at the MSC. In cases where remultiplexing takes place between the MSC and BSS a translation may be necessary at the BSS.

If a 1544 kbit/s digital path is used, then the format of the circuit identity code (CIC) shall be as shown below:

The element is 2 octets in length:

8	7	6	5	4	3	2	1
Element identifier							
CIC (least significant bits)							
CIC (most significant bits)							

octet 1  
octet 2  
octet 3

### 3.2.2.3 Connection Release Requested

The element has a fixed length of one octet.

8	7	6	5	4	3	2	1
Element identifier							

octet 1

### 3.2.2.4 Resource Available

This element gives the number of full and half rate channels available on any given cell at the time of construction of the message.

It defines these parameters in terms of the number of channels available in five interference bands, the boundaries of these bands being set by O and M as follows:

Interference level: 0 -----

Band 1

X1 -----

Band 2

X2 -----

Band 3

X3 -----

Band 4

X4 -----

Band 5

X5 -----

The element is coded as follows:

8	7	6	5	4	3	2	1
Element identifier							
Number of full rate channels available in band 1							
Number of half rate channels available in band 1							
Number of full rate channels available in band 5							
Number of half rate channels available in band 5							

octet 1  
octet 2  
octet 3  
octet 4  
octet 5  
octet 18  
octet 19  
octet 20  
octet 21

Octets (2, 3, 4, 5) are then repeated for each of the other interference bands giving a total message length of 21 octets.

Octets 2 and 3 give a 16 bit binary representation of the number of full rate channels available for service but not currently assigned.

Octets 4 and 5 give a 16 bit binary representation of the number of half rate channels available for service but not currently assigned. This will include half rate channels already counted in octets 2 and 3, if these correspond to full rate channels that can be used as half rate channels.

(e.g. If there is a spare half rate channel and a spare full rate channel that can be used as two half rate channels, then the full rate count will be 1 and the half rate count will be 3).

Octets 3 and 5 are the least significant octets, and bit 1 is the least significant bit.

### 3.2.2.5 Cause

The cause element is used to indicate the reason for a particular event to have occurred and is coded as shown below.

The cause value is a single octet element if the extension bit (bit 8) is set to 0. If it is set to 1 then the cause value is a 2 octet field. If the value of the first octet of the cause field is 1XXX 0000 then the second octet is reserved for national applications (XXX will still indicate the class).

8	7	6	5	4	3	2	1	
Element identifier								octet 1
Length								octet 2
0/1 ext	Cause Value							octet 3
								(octet 4)

The length indicator is a binary representation of the length of the following element.

Cause Value:

Class (000):	Normal event
Class (001):	Normal event
Class (010):	Resource unavailable
Class (011):	Service or option not available, but implemented
Class (100):	Service or option not implemented or currently disabled, i.e. not supported
Class (101):	invalid message (eg parameter out of range)
Class (110):	protocol error
Class (111):	interworking

In the following table, "reserved for international use" means that this codepoint should not be used until a meaning has been assigned to it following the process of international standardisation. "Reserved for national use" indicates codepoints that may be used by operators without the need for international standardization.

Cause value							Cause Number	
Class		Value						
7	6	5	4	3	2	1		
0	0	0	0	0	0	0		Radio interface message failure
0	0	0	0	0	0	1		Radio interface failure
0	0	0	0	0	1	0		Uplink quality
0	0	0	0	0	1	1		Uplink strength
0	0	0	0	1	0	0		Downlink quality
0	0	0	0	1	0	1		Downlink strength
0	0	0	0	1	1	0		Distance
0	0	0	0	1	1	1		O and M intervention
0	0	0	1	0	0	0		Response to MSC invocation
0	0	0	1	0	0	1		Call control
0	0	0	1	0	1	0		Radio interface failure, reversion to old channel
0	0	0	1	0	1	1		Handover successful
0	0	0	1	1	0	0		Better Cell
0	0	0	1	1	0	1		Directed Retry
0	0	0	1	1	1	0		Joined group call channel
0	0	0	1	1	1	1		Traffic
0	0	1	0	0	0	0		Reduce load in serving cell
0	0	1	0	0	0	1		Traffic load in target cell higher than in source cell
0	0	1	0	0	1	0		Relocation triggered
0	0	1	0	1	0	0		NOTE Requested option not authorised
0	0	1	0	1	0	1		Alternative channel configuration requested (NOTE)
0	0	1	0	1	1	0		Response to an INTERNAL HANDOVER ENQUIRY message
0	0	1	0	1	1	1		INTERNAL HANDOVER ENQUIRY reject
0	0	1	1	0	0	0		Redundancy Level not adequate
0	0	1	1	0	0	1		} } Reserved for national use
0	0	1	1	1	1	1		}
0	1	0	0	0	0	0		Equipment failure
0	1	0	0	0	0	1		No radio resource available
0	1	0	0	0	1	0		Requested terrestrial resource unavailable
0	1	0	0	0	1	1		CCCH overload
0	1	0	0	1	0	0		Processor overload
0	1	0	0	1	0	1		BSS not equipped
0	1	0	0	1	1	0		MS not equipped
0	1	0	0	1	1	1		Invalid cell
0	1	0	1	0	0	0		Traffic Load
0	1	0	1	0	0	1		Preemption
0	1	0	1	0	1	0		DTM Handover - SGSN Failure
0	1	0	1	0	1	1		DTM Handover - PS Allocation failure
0	1	0	1	1	0	0		} } Reserved for national use
0	1	0	1	1	1	1		}
0	1	1	0	0	0	0		Requested transcoding/rate adaption unavailable
0	1	1	0	0	0	1		Circuit pool mismatch
0	1	1	0	0	1	0		Switch circuit pool
0	1	1	0	0	1	1		Requested speech version unavailable
0	1	1	0	1	0	0		LSA not allowed
0	1	1	0	1	0	1		Requested Codec Type or Codec Configuration unavailable
0	1	1	0	1	1	0		Requested A-Interface Type unavailable
0	1	1	0	1	1	1		Invalid CSG cell
0	1	1	1	0	0	0		} } Reserved for international use
								}

Cause value							Cause	
Class		Value					Number	
0	1	1	1	1	1	0		}
0	1	1	1	1	1	1		Requested Redundancy Level not available
1	0	0	0	0	0	0		Ciphering algorithm not supported
1	0	0	0	0	0	1		GERAN lu-mode failure
1	0	0	0	0	1	0		Incoming Relocation Not Supported Due To PUESBINE Feature
1	0	0	0	0	1	1		Access Restricted Due to Shared Networks (NOTE)
1	0	0	0	1	0	0		Requested Codec Type or Codec Configuration not supported
1	0	0	0	1	0	1		Requested A-Interface Type not supported
1	0	0	0	1	1	0		Requested Redundancy Level not supported
1	0	0	0	1	1	1		} Reserved for international use
1	0	0	1	0	0	0		} to } Reserved for national use
1	0	0	1	1	1	1		}
1	0	1	0	0	0	0		Terrestrial circuit already allocated
1	0	1	0	0	0	1		Invalid message contents
1	0	1	0	0	1	0		Information element or field missing
1	0	1	0	0	1	1		Incorrect value
1	0	1	0	1	0	0		Unknown Message type
1	0	1	0	1	0	1		Unknown Information Element
1	0	1	0	1	1	0		DTM Handover - Invalid PS Indication
1	0	1	0	1	1	1		Call Identifier already allocated
1	0	1	1	0	0	0		} to } Reserved for national use
1	0	1	1	1	1	1		}
1	1	0	0	0	0	0		Protocol Error between BSS and MSC
1	1	0	0	0	0	1		VGCS/VBS call non existent
1	1	0	0	0	1	0		DTM Handover - Timer Expiry
1	1	0	0	0	1	1		} to } Reserved for international use
1	1	0	0	1	1	1		}
1	1	0	1	0	0	0		} to } Reserved for national use
1	1	0	1	1	1	1		}
1	1	1	0	0	0	0		} to } Reserved for international use
1	1	1	0	1	1	1		}
1	1	1	1	0	0	0		} to } Reserved for national use
1	1	1	1	1	1	1		}

NOTE: This cause value is only sent by 3G\_MSC-B over the MAP/E interface.

### 3.2.2.6 IMSI

This information element identifies the International Mobile Subscriber Identity (see 3GPP TS 23.003). The IMSI is coded as a sequence of BCD digits, compressed two into each octet. This is a variable length element, and includes a length indicator.

The element coding is:

8	7	6	5	4	3	2	1	
Element identifier								octet 1
Length								octet 2
IMSI coded as the value part of the <i>Mobile Identity</i> IE defined in 3GPP TS 24.008 (NOTE 1)								octet 3-n
NOTE 1: The <i>Type of identity</i> field in the <i>Mobile Identity</i> IE shall be ignored by the receiver.								

### 3.2.2.7 TMSI

The TMSI is a fixed length element. The TMSI is an unstructured number of 4 octets in length.

The coding is:

8	7	6	5	4	3	2	1	
Element identifier								octet 1
Length								octet 2
TMSI								octet 3-6

The TMSI field is unstructured.

### 3.2.2.8 Number Of MSs

This is a fixed length element which indicates the number of handover candidates that have been sent to the MSC.

The coding is:

8	7	6	5	4	3	2	1	
Element identifier								octet 1
Number of handover candidates								octet 2

Octet 2 is a binary indication of the number of handover candidates. Bit 1 is the least significant bit.

### 3.2.2.9 Layer 3 Header Information

This element is used to supply the BSS with information that needs to be included in the header of layer 3 messages over the radio interface.

8	7	6	5	4	3	2	1	
Element identifier								octet 1
Length								octet 2
Protocol discriminator								octet 3
Transaction identifier								octet 4

The length indicator is a binary indication of the number of octets following in the element.

The transaction identifier and protocol discriminator fields are coded as defined in 3GPP TS 24.008. The protocol discriminator occupies bit 1 to 4 in octet 3 of Layer 3 header information, the Transaction identifier occupies bit 1 to 4 in octet 4 of the Layer 3 header information.



### 3.2.2.10 Encryption Information

This element contains the user data encryption information used to control any encryption equipment at the BSS.

It is a variable length element.

It is coded as follows:

8	7	6	5	4	3	2	1	
Element identifier								octet 1
Length								octet 2
Permitted algorithms								octet 3
Key								octet 4-n

The length indicator (octet 2) is a binary number indicating the absolute length of the contents after the length indicator octet.

The permitted algorithms octet is a bit map indicating the A5 encryption algorithms and no encryption. From this bit map the BSS may select an A5 algorithm or no encryption to be used.

Bit No	meaning
1	No encryption
2	GSM A5/1
3	GSM A5/2
4	GSM A5/3
5	GSM A5/4
6	GSM A5/5
7	GSM A5/6
8	GSM A5/7

A bit position encoded as 1 indicates that the BSS may use the option represented by that bit position. A bit position encoded as 0 indicates that the BSS shall not use the option represented by that bit position. A permitted algorithms octet containing all bits encoded as 0 shall not be used.

The key shall be present if at least one of the A5/1 or A5/3 encryption algorithms is permitted. Over MAP/E interface to 3G\_MSC-B the key shall be present if available. For VGCS/VBS calls, the key shall not be present unless the Encryption Information is being provided for when a VGCS talker communicates on a dedicated channel . When present, the key shall be 8 octets long.

### 3.2.2.11 Channel Type

This element contains all of the information that the BSS requires to determine the required radio resource(s).

The channel type information element has a minimum length of 5 octets and a maximum length of 13 octets. It is coded as follows:

8	7	6	5	4	3	2	1	
Element identifier								octet 1
Length								octet 2
Spare				Speech / data indicator				octet 3
Channel rate and type								octet 4
Permitted speech version indication / data rate + transparency indicator								octet 5 or octet 5 with extension (note)
NOTE: If the speech / data indicator (octet 3) indicates "speech" or "data" or "CTM Text Telephony", octet 5 may optionally be extended. Otherwise octet 5 shall not be extended.								

The "speech / data indicator" field is coded as follows:

code	meaning
------	---------

0001	Speech
0010	Data
0011	Signalling
0100	Speech + CTM Text Telephony

All other values are reserved.

For values 0001 and 0010 a dedicated terrestrial resource is also required. For value 0100 a CTM Text Telephony capable terrestrial resource is required.

The "channel rate and type" is coded as follows:

If octet 3 indicates data then octet 4 shall be coded as:

<b>code</b>	<b>meaning</b>
0000 1000	Full rate TCH channel Bm.
0000 1001	Half rate TCH channel Lm.
0000 1010	Full or Half rate TCH channel, Full rate preferred, changes allowed also after first channel allocation as a result of the request.
0000 1011	Full or Half rate TCH channel, Half rate preferred, changes allowed also after first channel allocation as a result of the request.
0001 1010	Full or Half rate TCH channel, Full rate preferred, changes not allowed after first channel allocation as a result of the request.
0001 1011	Full or Half rate TCH channel. Half rate preferred, changes not allowed after first channel allocation as a result of the request.
0010 0xxx	Full rate TCH channels in a multislot configuration, changes by the BSS of the the number of TCHs and if applicable the used radio interface rate per channel allowed after first channel allocation as a result of the request.
0011 0xxx	Full rate TCH channels in a multislot configuration, changes by the BSS of the number of TCHs or the used radio interface rate per channel not allowed after first channel allocation as a result of the request.

**xxx** (bits 3-1) indicates maximum number of traffic channels;

bits

<b>321</b>	<b>meaning</b>
000	1 TCHs
001	2 TCHs
010	3 TCHs
011	4 TCHs
100	5 TCHs
101	6 TCHs
110	7 TCHs
111	8 TCHs

All other values are reserved.

If octet 3 indicates speech or speech + CTM Text Telephony then octet 4 shall be coded as:

<b>code</b>	<b>meaning</b>
0000 1000	Full rate TCH channel Bm. Preference between the permitted speech versions for full rate TCH as indicated in octet 5, 5a etc.
0000 1001	Half rate TCH channel Lm. Preference between the permitted speech versions for half rate TCH as indicated in octet 5, 5a etc.
0000 1010	Full or Half rate TCH channel, Full rate preferred, changes between full rate and half rate allowed also after first channel allocation as a result of the request. Preference between the permitted speech versions for the respective channel rates as indicated in octet 5, 5a etc.
0000 1011	Full or Half rate TCH channel, Half rate preferred, changes between full rate and half rate allowed also after first channel allocation as a result of the request. Preference between the permitted speech versions for the respective channel rates as indicated in octet 5, 5a etc.
0001 1010	Full or Half rate TCH channel, Full rate preferred, changes between full rate and half rate not allowed after first channel allocation as a result of the request. Preference between the permitted speech versions for the respective channel rates as indicated in octet 5, 5a etc.

0001 1011	Full or Half rate TCH channel. Half rate preferred, changes between full rate and half rate not allowed after first channel allocation as a result of the request. Preference between the permitted speech versions for the respective channel rates as indicated in octet 5, 5a etc.
0000 1111	Full or Half rate TCH channel. Preference between the permitted speech versions as indicated in octet 5, 5a etc., changes between full and half rate allowed also after first channel allocation as a result of the request.
0001 1111	Full or Half rate TCH channel. Preference between the permitted speech versions as indicated in octet 5, 5a etc., changes between full and half rate not allowed after first channel allocation as a result of the request.

All other values are reserved.

If octet 3 indicates signalling then octet 4 shall be coded as:

<b>code</b>	<b>meaning</b>
0000 0000	SDCCH or Full rate TCH channel Bm or Half rate TCH channel Lm 0000 0001SDCCH.
0000 0010	SDCCH or Full rate TCH channel Bm.
0000 0011	SDCCH or Half rate TCH channel Lm.
0000 1000	Full rate TCH channel Bm.
0000 1001	Half rate TCH channel Lm.
0000 1010	Full or Half rate TCH channel, Full rate preferred, changes allowed also after first channel allocation as a result of the request.
0000 1011	Full or Half rate TCH channel, Half rate preferred, changes allowed also after first channel allocation as a result of the request.
0001 1010	Full or Half rate TCH channel, Full rate preferred, changes not allowed after first channel allocation as a result of the request.
0001 1011	Full or Half rate TCH channel. Half rate preferred, changes not allowed after first channel allocation as a result of the request.

All other values are reserved.

The "permitted speech version indication / data rate + transparency indicator" octet is coded as follows:

- If octet 3 indicates speech or speech + CTM Text Telephony then octet 5 shall be coded as follows:

8	7	6	5	4	3	2	1	
ext	permitted speech version identifier							Octet 5
ext	permitted speech version identifier							Octet 5a
ext	permitted speech version identifier							Octet 5b
ext	permitted speech version identifier							Octet 5c
ext	permitted speech version identifier							Octet 5d
ext	permitted speech version identifier							Octet 5e
ext	Permitted speech version identifier							Octet 5f
ext	Permitted speech version identifier							Octet 5g
0	Permitted speech version identifier							Octet 5h

Bit 8 indicates extension of octet 5.

- |   |   |
|---|---|
| 0 | no extension, i.e. value "0" indicates that this octet is the last octet.           |
| 1 | extension, i.e. value "1" indicates that at least one additional octet is included. |

- If more than one permitted speech version is indicated by octet 5 (with extension), then the speech version choice is left to the BSS.

Bits 7-1 indicate the permitted speech version identifier;

bits	<b>765 4321</b>	<b>meaning</b>
000 0001		GSM speech full rate version 1.
001 0001		GSM speech full rate version 2.
010 0001		GSM speech full rate version 3.
100 0001		GSM speech full rate version 4.
100 0010		GSM speech full rate version 5.
000 0101		GSM speech half rate version 1.

001 0101	GSM speech half rate version 2.
010 0101	GSM speech half rate version 3.
100 0110	GSM speech half rate version 4.
100 0101	GSM speech half rate version 6.

The GSM speech versions are also referred as follows (see 3GPP TS 26.103):

GSM speech full rate version 1:	GSM FR.
GSM speech full rate version 2:	GSM EFR.
GSM speech full rate version 3:	FR AMR.
GSM speech full rate version 4:	OFR AMR-WB.
GSM speech full rate version 5:	FR AMR-WB.
GSM speech half rate version 1:	GSM HR.
GSM speech half rate version 2:	not defined in this version of the protocol.
GSM speech half rate version 3:	HR AMR.
GSM speech half rate version 4:	OHR AMR-WB.
GSM speech half rate version 6:	OHR AMR.

All other values of permitted speech version identifiers are for future use. If an unknown value is received and more than one octet 5 is received the sender expects the receiver to behave as if it has made a choice of speech version.

The rules for coding preferences in octet 5, 5a - 5h are the following:

- In those cases when one specific channel rate is indicated in octet 4, the non-empty set of permitted speech versions is included. Within this set the permitted speech versions are included in order of speech version preferences.
- In those cases when a preference for a channel rate is indicated in octet 4, the non-empty sets of permitted speech versions for the respective channel rate are included in order of the channel rate preferences indicated in octet 4. Within a set of permitted speech versions for a channel rate, the permitted speech versions are included in order of speech version preferences.
- In those cases when no preference or specific channel rate is indicated in octet 4, the permitted speech versions are included in order of speech version preferences.

Always octet 5 has the highest preference followed by octet 5a and so on. For each channel rate allowed by octet 4 at least one speech version shall be present.

If octet 5 indicates no extension and bits 7-1 is coded "000 0001", then the preference is interpreted based upon the octet 4 value as follows:

- in those cases when octet 4 indicates one specific channel rate, then "speech version 1" for the indicated channel rate is permitted;
- in those cases when octet 4 indicates a preference for a channel rate, then "speech version 1" for any of the allowed channel rates is permitted;
- in those cases when octet 4 does neither indicate a preference for a channel rate nor a specific channel rate, then "speech version 1" for any of the allowed channel rates is permitted and speech full rate version 1 is preferred.

If octet 3 indicates data, and octet 4 does not indicate multislot configuration, then octet 5 shall be coded as follows:

8	7	6	5	4	3	2	1	
ext	T/NT	Rate						octet 5
ext	allowed r i/f rates						octet 5a	
ext	asymmetry indication		spare					octet 5b

Bit 8 indicates extension of octet 5.

- |   |   |
|---|---|
| 0 | no extension, i.e. value "0" indicates that this octet is the last octet.           |
| 1 | extension, i.e. value "1" indicates that at least one additional octet is included. |

Bit 7:

0	Transparent service
1	Non-transparent service.

For non-transparent service bits 6-1 indicate the radio interface data rate;

<b>65 4321</b>	<b>meaning</b>
00 0000	12 kbit/s if the channel is a full rate TCH; or 6 kbit/s if the channel is a half rate TCH
11 0100	43,5 kbit/s
11 0001	29 kbit/s
01 1000	14,5 kbit/s
01 0000	12 kbits/s
01 0001	6 kbits/s

If bit 7 in octet 5 indicates non-transparent service and octet 5a is included the 'rate' in octet 5 indicates the wanted air interface data rate and the 'allowed r i/f rates' indicates all possible data rates allowed.

All other values are reserved.

For transparent service bits 6-1 indicate the data rate;

<b>65 4321</b>	<b>meaning</b>
11 1010	32,0 kbit/s
11 1001	28,8 kbit/s
01 1000	14,4 kbit/s
01 0000	9,6 kbit/s
01 0001	4,8 kbit/s
01 0010	2,4 kbit/s
01 0011	1,2 kbit/s
01 0100	600 bit/s
01 0101	1 200/75 bit/s (1 200 network-to-MS / 75 MS-to-network)

If bit 7 in octet 5 indicates transparent service octet 5 shall not be extended.

All other values are reserved.

Octet 5a shall be coded as follows;

Bit 8	reserved for extension. A coding of 0 indicates no extension
-------	---

Bits 7 to 1 indicate allowed radio interface data rate, per channel;

Bit 7:	0 43,5 kbit/s (TCH/F43.2) not allowed 1 43,5 kbit/s (TCH/F43.2) allowed
Bit 6:	0 32,0 kbit/s (TCH/F32.0) not allowed 1 32,0 kbit/s (TCH/F32.0) allowed
Bit 5:	0 29,0 kbit/s (TCH/F28.8) not allowed 1 29,0 kbit/s (TCH/F28.8) allowed
Bit 4:	0 14,5 kbit/s (TCH/F14.4) not allowed 1 14,5 kbit/s (TCH/F14.4) allowed
Bit 3:	Spare
Bit 2:	0 12,0 kbit/s (TCH/F9.6) not allowed 1 12,0 kbit/s (TCH/F9.6) allowed
Bit 1:	0 6,0 kbit/s (TCH/F4.8) not allowed 1 6,0 kbit/s (TCH/F4.8) allowed

Octet 5b shall be coded as follows:

Bit 8	reserved for extension.
-------	-------------------------

A coding of 0 indicates no extension

Bits 7 and 6 indicate the asymmetry preference:

Bit 76	
00	Not applicable
10	Downlink biased asymmetry is preferred
01	Uplink biased asymmetry is preferred
11	Spare

Bits 5 to 1 are spare

NOTE 1: "Not applicable" means that a symmetric service is preferred.

If octet 5b is not included, symmetry shall be presumed.

If octet 3 indicates data and octet 4 indicates Full rate TCH channels in a multislot configuration, octet 5 and 5a shall be coded as follows:

8	7	6	5	4	3	2	1	
ext	T/NT	Rate						octet 5
ext	allowed r i/f rates						octet 5a	
ext	asymmetry indication	spare						octet 5b

Octet 5 shall be coded as follows;

Bit 8:	extension bit
	0 indicates no extension
	1 indicates that at least one additional octet is included
Bit 7:	0 Transparent service
	1 Non-transparent service.

For non-transparent service bits 6-1 indicates wanted total radio interface data rate:

<b>65 4321</b>	<b>meaning</b>
01 0110	58 / 58 kbit/s (4 x 14,5 kbit/s or 2 x 29,0 kbit/s)
01 0100	48,0 / 43,5 / 43,5 kbit/s (4 x 12 kbit/s or 3 x 14,5 kbit/s or 1 x 43,5 kbit/s)
01 0011	36,0 / 29,0 / 29,0 kbit/s (3 x 12 kbit/s or 2 x 14,5 kbit/s or 1 x 29,0 kbit/s)
01 0010	24,0 / 24,0 (4 x 6 kbit/s or 2 x 12 kbit/s)
01 0001	18,0 / 14,5 kbit/s (3 x 6 kbit/s or 1 x 14,5 kbit/s)
01 0000	12,0 / 12,0 kbit/s (2 x 6 kbit/s or 1 x 12 kbit/s)

All other values are reserved.

For transparent service bits 6-1 indicates requested air interface user rate:

<b>65 4321</b>	<b>meaning</b>
01 1111	64 kbit/s, bit transparent
01 1110	56 kbit/s, bit transparent
01 1101	56 kbit/s
01 1100	48 kbit/s
01 1011	38,4 kbit/s
01 0001	32 kbit/s
01 1010	28,8 kbit/s
01 1001	19,2 kbit/s
01 1000	14,4 kbit/s
01 0000	9,6 kbit/s

All other values are reserved.

Octet 5a shall be coded as follows:

Bit 8	reserved for extension.
-------	-------------------------

A coding of 0 indicates no extension

Bits 7 to 1: indicates allowed radio interface data rate, per channel:

Bit 7:	0	43,5 kbit/s (TCH/F43.2) not allowed
	1	43,5 kbit/s (TCH/F43.2) allowed
Bit 6:	0	32,0 kbit/s (TCH/F32.0) not allowed
	1	32,0 kbit/s (TCH/F32.0) allowed
Bit 5:	0	29,0 kbit/s (TCH/F28.8) not allowed
	1	29,0 kbit/s (TCH/F28.8) allowed
Bit 4:	0	14,5/14,4 kbit/s (TCH/F14.4) not allowed
	1	14,5/14,4 kbit/s (TCH/F14.4) allowed
Bit 3:	Spare	
Bit 2:	0	12,0/9,6 kbit/s (TCH F/9.6) not allowed
	1	12,0/9,6 kbit/s (TCH F/9.6) allowed
Bit 1:	0	6,0/4,8 kbit/s (TCH F/4.8) not allowed
	1	6,0/4,8 kbit/s (TCH F/4.8) allowed

If octet 5a is not included, allowance of radio interface data rates of 12.0 and 6.0 shall be presumed.

NOTE 2: For data services, the information in the channel type Information Element is used to set the "E-bits" and map the "D-bits" (as described in 3GPP TS 44.002 and 3GPP TS 48.020) and to select the correct channel coding.

NOTE 3: 43,5 kbit/s is used only for nontransparent services.

NOTE 4: If octet 5 bits 6-1 indicates requested air interface user rate but octet 5a indicates no allowed radio interface data rate in multislot configuration, then the service requested by the subscriber cannot, due to limitations of the mobile station or the network it is attached to, be provided in GSM, but by another RAT.

Octet 5b is coded as follows:

Bit 8	reserved for extension.
	A coding of 0 indicates no extension

Bits 7 and 6 indicate the asymmetry preference:

Bit	<b>meaning</b>
00	Not applicable
10	Downlink biased asymmetry is preferred
01	Uplink biased asymmetry is preferred
11	Spare

Bits 5 to 1 are spare

NOTE 5: "Not applicable" means that a symmetric service is preferred.

If octet 5b is not included, symmetry shall be presumed.

If octet 3 indicates signalling then octet 5 is spare.

### 3.2.2.12 Periodicity

This element defines the periodicity of a particular procedure. It is fixed length, 2 octets.

The coding is as follows:

8	7	6	5	4	3	2	1	
Element identifier								octet 1
Periodicity								octet 2

When the Resource Indication Method IE is set to either "method i) of sub-clause 3.1.3.1" or "method iii) of sub-clause 3.1.3.1" and the periodicity parameter is not 0000 0000 then the coding of the periodicity parameter is:

```
0000 0001    Period
1111 1111    -
```

where the period is the binary value of octet 2 x 100 ms (ie 100 ms to 25,500 ms).

When the Resource Indication Method IE is set to "method i) of sub-clause 3.1.3.1" and the periodicity parameter is 0000 0000 then the BSS shall ignore this IE.

When the Resource Indication Method IE is set to "method iii) of sub-clause 3.1.3.1" and the periodicity parameter is 0000 0000 then the BSS shall treat the message according to sub-clause 3.1.19.4, case 2.

When the Resource Indication Method IE is set to either "method ii) of sub-clause 3.1.3.1" or "method iv) of sub-clause 3.1.3.1" then the Periodicity IE shall be ignored.

### 3.2.2.13 Extended Resource Indicator

This element defines which additional resource information related to a given cell the BSS shall transfer to the MSC. It may also indicate the subsequent reporting mode for that cell.

The coding is as follows:

8	7	6	5	4	3	2	1	
Element identifier								octet 1
spare					SM	TARR		octet 2
SM: Subsequent mode.								
TARR: Total Accessible Resource Requested.								

The coding of the Total Accessible Resource Requested field is as follows:

- 0 No extra Resource Information is requested.
- 1 The total number of accessible channels is requested.

If the Resource Indication Method is not set to "method ii) of sub-clause 3.1.3.1" then the Subsequent Mode field is ignored.

If the Resource Indication Method is set to "method ii) of sub-clause 3.1.3.1" then the Subsequent Mode field is decoded as follows:

- 0 method iv) of sub-clause 3.1.3.1.
- 1 if the reporting mode prior to receipt of this IE was i) or iii) of sub-clause 3.1.3.1 then the subsequent mode shall be respectively i) or iii); otherwise the subsequent mode shall be method iv) of sub-clause 3.1.3.1.

### 3.2.2.14 Total Resource Accessible

This element gives the total number of full and half rate channels accessible on any given cell at the time of construction of the message.

It defines these parameters in terms of the number of channels which are accessible or in use. No separation between the defined interference bands is made.

The element is coded as follows:



8	7	6	5	4	3	2	1	
Element identifier								octet 1
Total number of accessible full rate channels								octet 2 octet 3
Total number of accessible half rate channels								octet 4 octet 5

Octets 2 and 3 give a 16 bit binary representation of the total number of full rate channels accessible (i.e. available for service or currently assigned).

Octets 4 and 5 give a 16 bit binary representation of the number of half rate channels accessible (i.e. available for service or currently assigned). This will include half rate channels already counted in octets 2 and 3, if these correspond to full rate channels that can be used as half rate channels.

(eg. If there is an accessible half rate channel and an accessible full rate channel that can be used as two half rate channels, then the full rate count will be 1 and the half rate count will be 3).

Octets 3 and 5 are the least significant octets, and bit 1 is the least significant bit.

### 3.2.2.15 LSA Identifier

This element uniquely identifies a LSA and is of fixed length containing the following fields:

8	7	6	5	4	3	2	1	
Element identifier								octet 1
Length								octet 2
LSA ID								octet 3
LSA ID cont.								octet 4
LSA ID cont.								octet 5

The octets 3-5 are coded as specified in 3GPP TS 23.003, 'Identification of Localised Service Area'. Bit 8 of octet 3 is the MSB.

### 3.2.2.16 LSA Identifier List

This element uniquely identifies LSAs and is of variable length containing the following fields:

8	7	6	5	4	3	2	1	
Element identifier								octet 1
Length								octet 2
Spare							EP	octet 3
LSA identification 1								octet 4-6
⋮								⋮
LSA identification n								.. to 3+3n

The coding of octet 2 is a binary number indicating the length of the remaining element. The length depends on the number of LSAs to be identified. If the escape PLMN (see 3GPP TS 43.073) is broadcast the EP bit (bit 1 of octet 3) is set to 1, otherwise it is set to 0.

8	7	6	5	4	3	2	1	
LSA ID								octet x+1
LSA ID cont.								octet x+2
LSA ID cont.								octet x+3

Where  $x = 3 + 3(i-1)$

The octets (x+1)-(x+3) are coded as shown in 3GPP TS 23.003, 'Identification of Localised Service Area'. Bit 8 of octet (x+1) is the MSB.

### 3.2.2.17 Cell Identifier

This element uniquely identifies a cell within a BSS and is of variable length containing the following fields:

8	7	6	5	4	3	2	1	
Element identifier								octet 1
Length								octet 2
Spare				Cell identification discriminator				octet 3
Cell identification								octet 4-n

The coding of octet 2 is a binary number indicating the length of the remaining element. The length depends on the Cell identification discriminator (octet 3).

The coding of "Cell identification discriminator" (bits 1 to 4 of octet 3) is a binary number indicating if the whole or a part of Cell Global Identification, CGI, according to 3GPP TS 23.003 is used for cell identification in octet 4-n. The "Cell identification discriminator" is coded as follows:

0000	The whole Cell Global Identification, CGI, is used to identify the cell.
0001	Location Area Code, LAC, and Cell Identity, CI, is used to identify the cell.
0010	Cell Identity, CI, is used to identify the cell.
0011	No cell is associated with the transaction.
1000	Intersystem Handover to UTRAN or cdma2000. PLMN-ID, LAC and RNC-ID (or Extended RNC-ID), is used to identify the target RNC.
1001	Intersystem Handover to UTRAN or cdma2000. The RNC-ID (or Extended RNC-ID) is used to identify the target RNC.
1010	Intersystem Handover to UTRAN or cdma2000. LAC and RNC-ID (or Extended RNC-ID) are used to identify the target RNC.
1011	Serving Area Identity, SAI, is used to identify the Serving Area of UE within UTRAN or cdma2000 or to indicate an E-UTRAN source.
1100	LAC, RNC-ID (or Extended RNC-ID) and Cell Identity, CI, is used to identify a UTRAN cell for cell load information.

All other values are reserved.

The coding of octet 4-n depends on the Cell identification discriminator (octet 3). Below the coding is shown for each Cell identification discriminator:

NOTE: no coding is specified for a Cell identification discriminator value of "0011" as no additional information is required.

#### Coding of Cell Identification for Cell identification discriminator = 0000

8	7	6	5	4	3	2	1	
MCC dig 2				MCC dig 1				octet 4
MNC dig 3				MCC dig 3				octet 5
MNC dig 2				MNC dig 1				octet 6
LAC								octet 7
LAC cont.								octet 8
CI value								octet 9
CI value cont								octet 10

The octets 4-8 are coded as shown in 3GPP TS 24.008, Table 'Location Area Identification information element'.

The octet 5 bits 5-8 are filled by '1111' if 2 digit MNC is used.

The octets 9-10 are coded as shown in 3GPP TS 24.008, Table 'Cell Identity information element'.

#### Coding of Cell Identification for Cell identification discriminator = 0001

8	7	6	5	4	3	2	1	
LAC								octet 4
LAC cont.								octet 5
CI value								octet 6
CI value cont								octet 7

#### Coding of Cell Identification for Cell identification discriminator = 0010

8	7	6	5	4	3	2	1	
CI value								octet 4
CI value cont								octet 5

The octets 4-5 are coded as shown in 3GPP TS 24.008, Table 'Cell Identity information element'

#### Coding of Cell Identification for Cell identification discriminator = 1000

For intersystem handover from GSM to UMTS or cdma2000:

8	7	6	5	4	3	2	1	
MCC dig 2				MCC dig 1				octet 4
MNC dig 3				MCC dig 3				octet 5
MNC dig 2				MNC dig 1				octet 6
LAC								octet 7
LAC cont.								octet 8
RNC-ID (or Extended RNC-ID)								octet 9
RNC-ID (or Extended RNC-ID) cont.								octet 10

The octets 4-8 are coded as shown in 3GPP TS 24.008, Table 'Location Area Identification information element'.

The octet 5 bits 5-8 are filled by '1111' if 2 digit MNC is used.

The octets 9-10 are coded as the RNC-ID (0..4095) or the Extended RNC-ID (4096..65535) specified in 3GPP TS 25.413 [31]:

- The least significant bit of RNC-ID is octet 10 bit 1 and most significant bit is octet 9 bit 4. In the octet 9 bits 5-8 are filled by '0000'.
- The least significant bit of Extended RNC-ID is octet 10 bit 1 and most significant bit is octet 9 bit 8.

#### Coding of Cell Identification for Cell identification discriminator = 1001

For intersystem handover from GSM to UMTS or cdma2000:

8	7	6	5	4	3	2	1	
RNC-ID (or Extended RNC-ID)								octet 4
RNC-ID (or Extended RNC-ID) cont.								octet 5

The octets 4-5 are coded as the RNC-ID (0..4095) or the Extended RNC-ID (4096..65535) specified in 3GPP TS 25.413 [31]:

- The least significant bit of RNC-ID is octet 5 bit 1 and most significant bit is octet 4 bit 4. In the octet 4 bits 5-8 are filled by '0000'.
- The least significant bit of Extended RNC-ID is octet 5 bit 1 and most significant bit is octet 4 bit 8.

#### Coding of Cell Identification for Cell identification discriminator = 1010

For intersystem handover from GSM to UMTS or cdma2000:

8	7	6	5	4	3	2	1	
LAC								octet 4
LAC cont.								octet 5
RNC-ID (or Extended RNC-ID)								octet 6
RNC-ID (or Extended RNC-ID) cont.								octet 7

The octets 4-5 are coded as shown in 3GPP TS 24.008, Table 'Location Area Identification information element'.

The octets 6-7 are coded as the RNC-ID (0..4095) or the Extended RNC-ID (4096..65535) specified in 3GPP TS 25.413 [31]:

- The least significant bit of RNC-ID is octet 7 bit 1 and most significant bit is octet 6 bit 4. In the octet 6 bits 5-8 are filled by '0000'.
- The least significant bit of Extended RNC-ID is octet 7 bit 1 and most significant bit is octet 6 bit 8.

### Coding of Cell Identification for Cell identification discriminator = 1011

The coding of SAI is defined in 3GPP TS 25.413, without the protocol extension container.

NOTE: A default value of SAI can be defined in the MSC Server enhanced for SRVCC to be used as identifier of an E-UTRAN source in case of SRVCC.

### Coding of Cell Identification for Cell identification discriminator = 1100

For identification of a UTRAN cell for cell load information:

8	7	6	5	4	3	2	1	
MCC dig 2				MCC dig 1				octet 4
MNC dig 3				MCC dig 3				octet 5
MNC dig 2				MNC dig 1				octet 6
LAC								octet 7
LAC cont.								octet 8
RNC-ID (or Extended RNC-ID)								octet 9
RNC-ID (or Extended RNC-ID) cont.								octet 10
CI value								octet 11
CI value cont								octet 12

The octets 4-8 are coded as shown in 3GPP TS 24.008, Table 'Location Area Identification information element'.

The octet 5 bits 5-8 are filled by '1111' if 2 digit MNC is used.

The octets 9-10 are coded as the RNC-ID (0..4095) or the Extended RNC-ID (4096..65535) specified in 3GPP TS 25.413 [31]:

- The least significant bit of RNC-ID is octet 10 bit 1 and most significant bit is octet 9 bit 4. In the octet 9 bits 5-8 are filled by '0000'.
- The least significant bit of Extended RNC-ID is octet 10 bit 1 and most significant bit is octet 9 bit 8.

The octets 11-12 are coded as shown in 3GPP TS 24.008, Table 'Cell Identity information element'.

### 3.2.2.18 Priority

This element indicates the priority of the request. It is coded as follows:

8	7	6	5	4	3	2	1	
Element identifier								octet 1
Length								octet 2
Priority								octet 3

Octet 2 is a binary indication of the length of the rest of the element.

Octet 3 is coded as follows:

8	7	6	5	4	3	2	1	
spare	pci	priority level			qa	pvi	octet 3	

Bit 8 is spare, set to 0

pci = Preemption Capability indicator (see note)

- 0 this allocation request shall not preempt an existing connection.
- 1 this allocation request may preempt an existing connection.

priority level:

- 6 5 4 3
- 0 0 0 0 spare
- 0 0 0 1 priority level 1 = highest priority
- 0 0 1 0 priority level 2 = second highest priority
- :: ::
- 1 1 1 0 priority level 14 = lowest priority
- 1 1 1 1 priority not used

qa = queuing allowed indicator

- 0 queuing not allowed
- 1 queuing allowed

pvi = Preemption Vulnerability indicator (see note)

- 0 this connection shall not be preempted by another allocation request
- 1 this connection might be preempted by another allocation request

NOTE: Preemption Capability indicator applies to the allocation of resources for an event and as such it provides the trigger to the preemption procedures/processes of the BSS. Preemption Vulnerability indicator applies for the entire duration of a connection and as such indicates whether the connection is a target of the preemption procedures/processes of the BSS.

### 3.2.2.19 Classmark Information Type 2

The classmark information type 2 defines certain attributes of the mobile station equipment in use on a particular transaction.

It is coded as follows:

8	7	6	5	4	3	2	1	
Element identifier								octet 1
Length								octet 2
Classmark								octet 3-5

Octet 2 is a binary indication of the length of the remainder of the element in octets. The length shall be determined by the length of the Mobile Station Classmark 2 element of 3GPP TS 24.008.

The classmark octets 3, 4 and 5 are coded in the same way as the equivalent octets in the Mobile station classmark 2 element of 3GPP TS 24.008.

### 3.2.2.20 Classmark Information Type 3

The classmark information type 3 defines certain attributes of the mobile station equipment in use on a particular transaction.

It is coded as follows:

8	7	6	5	4	3	2	1	
Element identifier								octet 1
Length								octet 2
Classmark								octet 3-34

Octet 2 is a binary indication of the length of the remainder of the element in octets. The length octet has a minimum value of 1 and a maximum of 32. The length shall be determined by the length of the Mobile Station Classmark 3 element of 3GPP TS 24.008.

The classmark octets 3 to 34 are coded in the same way as the equivalent octets in the Mobile station classmark 3 element of 3GPP TS 24.008.

### 3.2.2.21 Interference Band To Be Used

This fixed length element is coded as follows:

8	7	6	5	4	3	2	1	
Element identifier								octet 1
Band to be used								octet 2

Octet 2 is coded as:

- Bits 876 Spare
- Bits 54321 A bit map indicating which interference bands are acceptable, the LSB represents the least level of interference.

### 3.2.2.22 RR Cause

This fixed length element is passed from the radio interface to the MSC transparently, when received in a 3GPP TS 24.008 message.

8	7	6	5	4	3	2	1	
Element identifier								octet 1
RR cause								octet 2

Octet 2 is coded as the equivalent field from 3GPP TS 24.008.

### 3.2.2.23 LSA Information

This element uniquely identifies LSAs, the priority, the preferential access indicator and the active mode support indicator of each LSA. The access right outside these LSAs is also defined. The element is of variable length containing the following fields:

8	7	6	5	4	3	2	1	
Element identifier								octet 1
Length								octet 2
Spare							LSA only	octet 3
LSA identification and attributes 1								octet 4-7
⋮								
LSA identification and attributes n								.. to 3+4n

The coding of octet 2 is a binary number indicating the length of the remaining element. The length depends on the number of LSAs to be identified.

If the LSA only access indicator (bit 1 of octet 3) is set to 1 the subscriber has only access to the LSAs that are defined by the LSA Information element. The LSA only access indicator is set to 0 for allowing an emergency call.

Coding of the i-th LSA identification with attributes:

8	7	6	5	4	3	2	1	
spare		act	pref	priority				
LSA ID								octet x+1
LSA ID cont.								octet x+2
LSA ID cont.								octet x+3
LSA ID cont.								octet x+4

Where  $x = 3 + 4(i-1)$

Bits 1 to 4 of octet (x+1) define the priority of the LSA identification.

Bit 4321

0000	priority 1 = lowest priority
0001	priority 2 = second lowest priority
::::	
1111	priority 16= highest priority

If the preferential access indicator (bit 5 of octet (x+1)) is set to 1 the subscriber has preferential access in the LSA. If the active mode support indicator (bit 6 of octet (x+1)) is set to 1 the subscriber has active mode support in the LSA.

The octets (x+2)-(x+4) are coded as specified in 3GPP TS 23.003, 'Identification of Localised Service Area'. Bit 8 of octet (x+2) is the MSB.

### 3.2.2.24 Layer 3 Information

This is a variable length element used to pass radio interface messages from one network entity to another.

8	7	6	5	4	3	2	1	
Element identifier								octet 1
Length								octet 2
Layer 3 information								octet 3-n

Octet 1 identifies the element. Octet 2 gives the length of the following layer 3 information.

Octet j (j = 3, 4, ..., n) is the unchanged octet j-2 of either:

- a radio interface layer 3 message as defined in 3GPP TS 44.018; or
- Handover To UTRAN Command as defined in UMTS 25.331, where n-2 is equal to the length of that radio interface layer 3 message.

### 3.2.2.25 DLCI

This is a fixed length element indicating the radio interface SAPI.

8	7	6	5	4	3	2	1	
Element identifier								octet 1
DLCI								octet 2

Octet 2 is coded as the DLCI octet described in 3GPP TS 48.006.

### 3.2.2.26 Downlink DTX Flag

A fixed length element indicating whether the DTX function in the BSS is to be disabled on a particular radio channel.

8	7	6	5	4	3	2	1	
Element identifier								octet 1
Downlink DTX flag								octet 2

The Downlink DTX Flag is coded as follows:

- bits 8 to 2 are spare;

- bit 1 is set to one if the MSC forbids the BSS to activate DTX in the downlink direction; it is set to 0 otherwise.

In case of compressed speech over RTP/UDP/IP or TFO on the A-Interface the Downlink DTX flag shall be neglected by the BSS. Independent of the Downlink DTX flag the speech payload stream may contain SID frames, indicating the start of a silence period and (not contain) missing RTP frames during the silence period, i.e. DTX may be active in downlink. The BSS shall be able to cope with that. The BSS may treat these calls as if DTX in downlink is activated.

### 3.2.2.27 Cell Identifier List

This element uniquely identifies cells and is of variable length containing the following fields:

8	7	6	5	4	3	2	1	
Element identifier								octet 1
Length								octet 2
Spare				Cell identification discriminator				octet 3
Cell identification 1								octet 4-3+m
...								
Cell identification n								.. to 3+nm

The coding of octet 2 is a binary number indicating the Length of the remaining element. The Length depends on the Cell identification discriminator (bits 1 to 4 of octet 3) as well as the number of cells to be identified.

The coding of the Cell identification discriminator is a binary number indicating if the whole or a part of Cell Global identification, CGI, according to 3GPP TS 23.003 is used for cell identification of the cells in the list. The Cell identification discriminator is coded as follows:

0000	The whole Cell Global Identification, CGI, is used to identify the cells.
0001	Location Area Code, LAC, and Cell Identify, CI, is used to identify the cells.
0010	Cell Identity, CI, is used to identify the cells.
0011	No cell is associated with the transaction.
0100	Location Area Identification, LAI, is used to identify all cells within a Location Area.
0101	Location Area Code, LAC, is used to identify all cells within a location area.
0110	All cells on the BSS are identified.
1000	Intersystem Handover to UTRAN or cdma2000. PLMN-ID, LAC, and RNC-ID (or Extended RNC-ID), are encoded to identify the target RNC.
1001	Intersystem Handover to UTRAN or cdma2000. The RNC-ID (or Extended RNC-ID) is coded to identify the target RNC.
1010	Intersystem Handover to UTRAN or cdma2000. LAC and RNC-ID (or Extended RNC-ID) are encoded to identify the target RNC.

All other values are reserved.

Values 0100, 0101 and 0110 are only applicable for page message.

The coding of the Cell Identifications 1 to n (octets 4 to 4+nm) depends on the Cell identification discriminator (octet 3). Below the coding of the i-th Cell Identification is shown for each Cell identification discriminator (with "i" in the range 1 to n):

NOTE: No coding is specified for Cell identification discriminator values of "0011" and "0110" as no additional information is required.

#### Coding of the i-th Cell Identification for Cell identification discriminator = 0000

8	7	6	5	4	3	2	1	
MCC dig 2				MCC dig 1				octet x+1
MNC dig 3				MCC dig 3				octet x+2
MNC dig 2				MNC dig 1				octet x+3
LAC								octet x+4
LAC cont.								octet x+5
CI value								octet x+6
CI value cont								octet x+7



Where  $x = 3 + 7(i-1)$ .

The octets (x+1)-(x+5) are coded as shown in 3GPP TS 24.008, Table 'Location Area Identification information element'.

The octets (x+6)-(x+7) are coded as shown in 3GPP TS 24.008, Table 'Cell Identity information element'.

*MNC dig 3* digit shall be set to '1111' if 2-digit MNC is used.

#### Coding of i-th Cell Identification for Cell identification discriminator = 0001

8	7	6	5	4	3	2	1	
LAC								octet x+1
LAC cont.								octet x+2
CI value								octet x+3
CI value cont								octet x+4

Where  $x = 3 + 4(i-1)$

The octets (x+1)-(x+2) are coded as shown in 3GPP TS 24.008, Table 'Location Area Identification information element'.

The octets (x+3)-(x+4) are coded as shown in 3GPP TS 24.008, Table 'Cell Identity information element'.

#### Coding of i-th Cell Identification for Cell identification discriminator = 0010

8	7	6	5	4	3	2	1	
CI value								octet x+1
CI value cont								octet x+2

Where  $x = 3 + 2(i-1)$

The octets (x+1)-(x+2) are coded as shown in 3GPP TS 24.008, Table 'Cell Identity information element'.

#### Coding of i-th Cell Identification for Cell identification discriminator = 0100

8	7	6	5	4	3	2	1	
MCC dig 2				MCC dig 1				octet x+1
MNC dig 3				MCC dig 3				octet x+2
MNC dig 2				MNC dig 1				octet x+3
LAC								octet x+4
LAC cont.								octet x+5

Where  $x = 3 + 5(i-1)$

The octets (x+1)-(x+5) are coded as shown in 3GPP TS 24.008, Table 'Location Area Identification information element'.

*MNC dig 3* digit shall be set to '1111' if 2-digit MNC is used.

#### Coding of i-th Cell Identification for Cell identification discriminator = 0101

8	7	6	5	4	3	2	1	
LAC								octet x+1
LAC cont.								octet x+2

Where  $x = 3 + 2(i-1)$

The octets (x+1)-(x+2) are coded as shown in 3GPP TS 24.008, Table 'Location Area Identification information element'.

The appropriate coding for not identified cells is "0" for all bits of LAC and CI for all possible Cell Identification Discriminator values.

**Coding of the Target ID for Cell identification discriminator = 1000**

For intersystem handover from GSM to UMTS or cdma2000:

8	7	6	5	4	3	2	1	
MCC dig 2				MCC dig 1				octet 4
MNC dig 3				MCC dig 3				octet 5
MNC dig 2				MNC dig 1				octet 6
LAC								octet 7
LAC cont.								octet 8
RNC-ID (or Extended RNC-ID)								octet 9
RNC-ID (or Extended RNC-ID) cont.								octet 10

The octets 4-8 are coded as shown in 3GPP TS 24.008, Table 'Location Area Identification information element'.

The octet 5 bits 5-8 are filled by '1111' if 2 digit MNC is used.

The octets 9-10 are coded as the RNC-ID (0..4095) or the Extended RNC-ID (4096..65535) specified in 3GPP TS 25.413 [31]:

- The least significant bit of RNC-ID is octet 10 bit 1 and most significant bit is octet 9 bit 4. In the octet 9 bits 5-8 are filled by '0000'.
- The least significant bit of Extended RNC-ID is octet 10 bit 1 and most significant bit is octet 9 bit 8.

**Coding of the Target ID for Cell identification discriminator = 1001**

For intersystem handover from GSM to UMTS or cdma2000:

8	7	6	5	4	3	2	1	
RNC-ID (or Extended RNC-ID)								octet 4
RNC-ID (or Extended RNC-ID) cont.								octet 5

The octets 4-5 are coded as the RNC-ID (0..4095) or the Extended RNC-ID (4096..65535) specified in 3GPP TS 25.413 [31]:

- The least significant bit of RNC-ID is octet 5 bit 1 and most significant bit is octet 4 bit 4. In the octet 4 bits 5-8 are filled by '0000'.
- The least significant bit of Extended RNC-ID is octet 5 bit 1 and most significant bit is octet 4 bit 8.

**Coding of the Target ID for Cell identification discriminator = 1010**

For intersystem handover from GSM to UMTS or cdma2000:

8	7	6	5	4	3	2	1	
LAC								octet 4
LAC cont.								octet 5
RNC-ID (or Extended RNC-ID)								octet 6
RNC-ID (or Extended RNC-ID) cont.								octet 7

The octets 4-5 are coded as shown in 3GPP TS 24.008, Table 'Location Area Identification information element'.

The octets 6-7 are coded as the RNC-ID (0..4095) or the Extended RNC-ID (4096..65535) specified in 3GPP TS 25.413 [31]:

- The least significant bit of RNC-ID is octet 7 bit 1 and most significant bit is octet 6 bit 4. In the octet 6 bits 5-8 are filled by '0000'.
- The least significant bit of Extended RNC-ID is octet 7 bit 1 and most significant bit is octet 6 bit 8.

### 3.2.2.27a Cell Identifier List Segment

In the VGCS/VBS Assignment procedure, the entire list of cells in the group call area is communicated to the BSS in one VGCS/VBS ASSIGNMENT REQUEST message and a sequence of (N) VGCS/VBS AREA CELL INFO messages (each message containing one CELL Identifier List Segment IE). The CELL Identifier List Segment IE is coded as follows:

8	7	6	5	4	3	2	1		
Element identifier								octet 1	
Length								octet 2	
Sequence Length				Sequence Number				octet 3	
Spare				Cell identification discriminator				octet 4	
Cell identification 1								octet 5	
...								to	
Cell identification n								octet 4+nm	

Octet 2 is a binary indication of the length of the remainder of the element in octets.

Octet 3 bits 1-4 represent the sequence number (i), 0 being the sequence number of the segment carried in the VGCS/VBS ASSIGNMENT REQUEST message, 1 to N the sequence numbers of the segments carried in the following VGCS/VBS AREA CELL INFO messages.

Octet 3 bits 5-8 represent the Sequence Number (N) of the last segment to be sent.

Octet 4 bits 1-4, contains the Cell Identification Discriminator that is used for the cell identifiers in this Cell Identifier List Segment. The coding of the Cell identification discriminator is a binary number indicating if the whole or a part of Cell Global identification, CGI, according to 3GPP TS 23.003 is used for cell identification of the cells in the list. The Cell identification discriminator is coded as follows:

0000	The whole Cell Global Identification, CGI, is used to identify the cells
0001	Location Area Code, LAC, and Cell Identify, CI, is used to identify the cells within a given MCC and MNC
0010	Cell Identity, CI, is used to identify the cells within a given MCC and MNC and LAC
0011	No cell is associated with the transaction
0100	Location Area Identification, LAI, is used to identify all cells within a Location Area
0101	Location Area Code, LAC, is used to identify all cells within a location area
0110	All cells on the BSS are identified
0111	MCC and MNC, is used to identify all cells within the given MCC and MNC

All other values are reserved.

Octet 5-4+nm contains the Cell Identification List. The coding of the Cell Identification List depends on the Cell identification discriminator (octet 4). Below is the coding of the Cell Identification List and the i-th Cell Identification is shown for each Cell identification discriminator (with "i" in the range 1 to n):

NOTE: No coding is specified for Cell identification discriminator values of "0011" and "0110" as no additional information is required.

Coding of the Cell Identification List for Cell identification discriminator = 0000

8	7	6	5	4	3	2	1		
Cell identification 1								octet 5	
...								to	
Cell identification n								octet 4+7n	

Coding of the i-th Cell Identification for Cell identification discriminator = 0000

8	7	6	5	4	3	2	1	
MCC dig 2				MCC dig 1				octet x+1
MNC dig 3				MCC dig 3				octet x+2
MNC dig 2				MNC dig 1				octet x+3
LAC								octet x+4
LAC cont.								octet x+5
CI value								octet x+6
CI value cont								octet x+7

Where  $x = 4 + 7(i-1)$ .

The octets (x+1)-(x+5) are coded as shown in 3GPP TS 24.008, Table 'Location Area Identification information element'.

The octets (x+6)-(x+7) are coded as shown in 3GPP TS 24.008, Table 'Cell Identity information element'.

MNC dig 3 digit shall be set to '1111' if 2-digit MNC is used.

Coding of the Cell Identification List for Cell identification discriminator = 0001

8	7	6	5	4	3	2	1	
MCC dig 2				MCC dig 1				octet 5
MNC dig 3				MCC dig 3				octet 6
MNC dig 2				MNC dig 1				octet 7
Cell identification 1								octet 8
...								to
Cell identification n								octet 7+4n

Coding of i-th Cell Identification for Cell identification discriminator = 0001

8	7	6	5	4	3	2	1	
LAC								octet x+1
LAC cont.								octet x+2
CI value								octet x+3
CI value cont								octet x+4

Where  $x = 7 + 4(i-1)$

The octets (x+1)-(x+2) are coded as shown in 3GPP TS 24.008, Table 'Location Area Identification information element'.

The octets (x+3)-(x+4) are coded as shown in 3GPP TS 24.008, Table 'Cell Identity information element'.

Coding of the Cell Identification List for Cell identification discriminator = 0010

8	7	6	5	4	3	2	1	
MCC dig 2				MCC dig 1				octet 5
MNC dig 3				MCC dig 3				octet 6
MNC dig 2				MNC dig 1				octet 7
LAC								octet 8
LAC cont.								octet 9
Cell identification 1								octet 10
...								to
Cell identification n								octet 9+2n

Coding of i-th Cell Identification for Cell identification discriminator = 0010:

8	7	6	5	4	3	2	1	
CI value								octet x+1
CI value cont								octet x+2

Where  $x = 9 + 2(i-1)$

The octets (x+1)-(x+2) are coded as shown in 3GPP TS 24.008, Table 'Cell Identity information element'.

Coding of the Cell Identification List for Cell identification discriminator = 0100

8	7	6	5	4	3	2	1
Cell identification 1							
...							
Cell identification n							

octet 5  
to  
octet 4+5n

Coding of i-th Cell Identification for Cell identification discriminator = 0100

8	7	6	5	4	3	2	1
MCC dig 2				MCC dig 1			
MNC dig 3				MCC dig 3			
MNC dig 2				MNC dig 1			
LAC							
LAC cont.							

octet x+1  
octet x+2  
octet x+3  
octet x+4  
octet x+5

Where  $x = 4 + 5(i-1)$

The octets (x+1)-(x+5) are coded as shown in 3GPP TS 24.008, Table 'Location Area Identification information element'.

MNC dig 3 digit shall be set to '1111' if 2-digit MNC is used.

Coding of the Cell Identification List for Cell identification discriminator = 0101

8	7	6	5	4	3	2	1
Cell identification 1							
...							
Cell identification n							

octet 5  
to  
octet 4+2n

Coding of i-th Cell Identification for Cell identification discriminator = 0101

8	7	6	5	4	3	2	1
LAC							
LAC cont.							

octet x+1  
octet x+2

Where  $x = 4 + 2(i-1)$

The octets (x+1)-(x+2) are coded as shown in 3GPP TS 24.008, Table 'Location Area Identification information element'.

Coding of the Cell Identification List for Cell identification discriminator = 0111

8	7	6	5	4	3	2	1
Cell identification 1							
...							
Cell identification n							

octet 5  
to  
octet 4+3n

Coding of i-th Cell Identification for Cell identification discriminator = 0111

8	7	6	5	4	3	2	1
MCC dig 2				MCC dig 1			
MNC dig 3				MCC dig 3			
MNC dig 2				MNC dig 1			

octet x+1  
octet x+2  
octet x+3

Where  $x = 4 + 3(i-1)$

The octets (x+1)-(x+3) are coded as shown in 3GPP TS 24.008, Table 'Location Area Identification information element'.

*MNC dig 3* digit shall be set to '1111' if 2-digit MNC is used.

The list of cells shall contain only those cells in the group call area that can be accessed through this BSS.

### 3.2.2.27b Cell Identifier List Segment for established cells

This information element contains a list of cells that have been established or re-established.

The *Cell Identifier List Segment for established cells* IE is coded as follows:

8	7	6	5	4	3	2	1	
Element identifier								octet 1
Length								octet 2
Spare				Cell identification Discriminator				octet 3
Cell identification List								octet 4 to octet 3+nm

Octet 2 is a binary indication of the length of the remainder of the element in octets.

Octet 3 bits 1-4 contain the Cell Identification Discriminator that is used for the cell identifiers in this Cell Identifier List Segment. The coding of the Cell identification discriminator is a binary number indicating if the whole or a part of Cell Global identification, CGI, according to 3GPP TS 23.003 is used for cell identification of the cells in the list. The Cell identification discriminator is coded as follows:

0000	The whole Cell Global Identification, CGI, is used to identify the cells.
0001	Location Area Code, LAC, and Cell Identify, CI, is used to identify the cells within a given MCC and MNC
0010	Cell Identity, CI, is used to identify the cells within a given MCC and MNC and LAC.
0100	Location Area Identification, LAI, is used to identify all cells within a Location Area
0101	Location Area Code, LAC, is used to identify all cells within a location area
0110	All cells on the BSS are identified
0111	MCC and MNC, is used to identify all cells within the given MCC and MNC

All other values are reserved.

Octets 4-3+nm contain the Cell Identification List. The coding of the Cell Identification List depends on the Cell identification discriminator (octet 3). Below is the coding of the Cell Identification List and the *i*-th Cell Identification is shown for each Cell identification discriminator (with "*i*" in the range 1 to *n*):

NOTE: No coding is specified for Cell identification discriminator value "0110" as no additional information is required.

Coding of the Cell Identification List for Cell identification discriminator = 0000

8	7	6	5	4	3	2	1	
Cell identification 1								octet 4
...								to
Cell identification n								octet 3+7n

Coding of the *i*-th Cell Identification for Cell identification discriminator = 0000

8	7	6	5	4	3	2	1	
MCC dig 2				MCC dig 1				octet x+1
MNC dig 3				MCC dig 3				octet x+2
MNC dig 2				MNC dig 1				octet x+3
LAC								octet x+4
LAC cont.								octet x+5
CI value								octet x+6
CI value cont								octet x+7

Where  $x = 3 + 7(i-1)$ .

The octets (x+1)-(x+5) are coded as shown in 3GPP TS 24.008, Table 'Location Area Identification information element'.

The octets (x+6)-(x+7) are coded as shown in 3GPP TS 24.008, Table 'Cell Identity information element'.

MNC dig 3 digit shall be set to '1111' if 2-digit MNC is used.

Coding of the Cell Identification List for Cell identification discriminator = 0001

8	7	6	5	4	3	2	1	
MCC dig 2				MCC dig 1				octet 4
MNC dig 3				MCC dig 3				octet 5
MNC dig 2				MNC dig 1				octet 6
Cell identification 1								octet 7
...								to
Cell identification n								octet 6+4n

Coding of i-th Cell Identification for Cell identification discriminator = 0001

8	7	6	5	4	3	2	1	
LAC								octet x+1
LAC cont.								octet x+2
CI value								octet x+3
CI value cont								octet x+4

Where  $x = 6 + 4(i-1)$

The octets (x+1)-(x+2) are coded as shown in 3GPP TS 24.008, Table 'Location Area Identification information element'.

The octets (x+3)-(x+4) are coded as shown in 3GPP TS 24.008, Table 'Cell Identity information element'.

Coding of the Cell Identification List for Cell identification discriminator = 0010

8	7	6	5	4	3	2	1	
MCC dig 2				MCC dig 1				octet 4
MNC dig 3				MCC dig 3				octet 5
MNC dig 2				MNC dig 1				octet 6
LAC								octet 7
LAC cont								octet 8
Cell identification 1								octet 9
...								to
Cell identification n								octet 8+2n

Coding of i-th Cell Identification for Cell identification discriminator = 0010:

8	7	6	5	4	3	2	1	
CI value								octet x+1
CI value cont								octet x+2

Where  $x = 8 + 2(i-1)$

The octets (x+1)-(x+2) are coded as shown in 3GPP TS 24.008, Table 'Cell Identity information element'.

Coding of the Cell Identification List for Cell identification discriminator = 0100

8	7	6	5	4	3	2	1	
Cell identification 1								octet 4
...								to
Cell identification n								octet 3+5n

Coding of i-th Cell Identification for Cell identification discriminator = 0100

08	7	6	5	4	3	2	1	
MCC dig 2				MCC dig 1				octet x+1
MNC dig 3				MCC dig 3				octet x+2
MNC dig 2				MNC dig 1				octet x+3
LAC								octet x+4
LAC cont.								octet x+5

Where  $x = 3 + 5(i-1)$

The octets (x+1)-(x+5) are coded as shown in 3GPP TS 24.008, Table 'Location Area Identification information element'.

Coding of the Cell Identification List for Cell identification discriminator = 0101

8	7	6	5	4	3	2	1	
Cell identification 1								octet 4
...								to
Cell identification n								octet 3+2n

Coding of i-th Cell Identification for Cell identification discriminator = 0101

8	7	6	5	4	3	2	1	
LAC								octet x+1
LAC cont.								octet x+2

Where  $x = 3 + 2(i-1)$

The octets (x+1)-(x+2) are coded as shown in 3GPP TS 24.008, Table 'Location Area Identification information element'.

Coding of the Cell Identification List for Cell identification discriminator = 0111

8	7	6	5	4	3	2	1	
Cell identification 1								octet 4
...								to
Cell identification n								octet 3+3n

Coding of i-th Cell Identification for Cell identification discriminator = 0111

8	7	6	5	4	3	2	1	
MCC dig 2				MCC dig 1				octet x+1
MNC dig 3				MCC dig 3				octet x+2
MNC dig 2				MNC dig 1				octet x+3

Where  $x = 3 + 3(i-1)$

The octets (x+1)-(x+3) are coded as shown in 3GPP TS 24.008, Table 'Location Area Identification information element'.

MNC dig 3 digit shall be set to '1111' if 2-digit MNC is used.

The list of cells shall contain only those cells in the group call area that can be accessed through this BSS.

### 3.2.2.27c Cell Identifier List Segment for cells to be established

This information element contains a list of cells that have been released or have not yet been established and (in either case) are to be established by the BSS.



The *Cell Identifier List Segment for cells to be established* IE is coded as follows:

8	7	6	5	4	3	2	1	
Element identifier								octet 1
Length								octet 2
Spare				Cell identification Discriminator				octet 3
Cell identification List								octet 4 to octet 3+nm

The Cell Identification Discriminator and Cell Identification List fields are coded as in the *Cell Identifier List Segment for established cells* IE (see sub-clause 3.2.2.27b).

3.2.2.27d (void)

3.2.2.27e Cell Identifier List Segment for released cells - no user present

This information element contains a list of cells in which the call was released because no user responded to the latest uplink access request.

The *Cell Identifier List Segment for released cells - no users present* IE is coded as follows:

8	7	6	5	4	3	2	1	
Element identifier								octet 1
Length								octet 2
Spare				Cell identification Discriminator				octet 3
Cell identification List								octet 4 to octet 3+nm

The Cell Identification Discriminator and Cell Identification List fields are coded as in the *Cell Identifier List Segment for established cells* IE (see sub-clause 3.2.2.27b).

3.2.2.27f Cell Identifier List Segment for not established cells - no establishment possible

This information element contains a list of cells in which the call has not been established or where the call was released and (in either case) establishment by the BSS is not possible.

The *Cell Identifier List Segment for not established cells - no establishment possible* IE is coded as follows:

8	7	6	5	4	3	2	1	
Element identifier								octet 1
Length								octet 2
Spare				Cell identification Discriminator				octet 3
Cell identification List								octet 4 to octet 3+nm

The Cell Identification Discriminator and Cell Identification List fields are coded as in the *Cell Identifier List Segment for established cells* IE (see sub-clause 3.2.2.27b).

3.2.2.28 Response Request

The presence of this element indicates that a Handover Required Reject message is required by the BSS, if the Handover Required message does not result in a handover.

The element has a fixed length of one octet:

8	7	6	5	4	3	2	1
Element identifier							

octet 1

### 3.2.2.29 Resource Indication Method

This element defines the way the BSS shall transfer the resource information related to a cell to the MSC. The coding is as follows:

8	7	6	5	4	3	2	1
Element identifier							
Spare				Resource indication method			

octet 1  
octet 2

The coding of the Resource Indication parameter is:

- 0000 the method i) of sub-clause 3.1.3.1 is selected;
  - 0001 the method ii) of sub-clause 3.1.3.1 is selected;
  - 0010 the method iii) of sub-clause 3.1.3.1 is selected;
  - 0011 the method iv) of sub-clause 3.1.3.1 is selected.
- All other values are reserved.

### 3.2.2.30 Classmark Information Type 1

The classmark information type 1 defines certain attributes of the mobile station equipment in use on a particular transaction.

It is coded as follows:

8	7	6	5	4	3	2	1
Element identifier							
Classmark							

octet 1  
octet 2

The classmark octet 2 is coded in the same way as the equivalent octet in the classmark 1 element of 3GPP TS 24.008.

### 3.2.2.31 Circuit Identity Code List

This element defines in conjunction with a Circuit Identity Code (sub-clause 3.2.2.2) a list of terrestrial channels.

8	7	6	5	4	3	2	1
Element identifier							
Length							
Range							
Status							

octet 1  
octet 2  
octet 3  
octet 4-35

The following codes are used in the range and status fields:

#### Range:

A number in pure binary representation ranging from 0 to 255. The number represented by the range code +1 indicates the range of circuits affected by the message.

#### Status:

The Status subfield contains up to 256 Status bits numbered from 0 up to 255. Status bit 0 is located in bit position 1 of the first Status subfield octet and refers to the circuit indicated in the CIC subfield{should be "associated Circuit Identity Code Information Element" not "CIC subfield"} itself. Other Status bits follow in numerical order.

Each Status bit is associated with a circuit identification code such that Status bit  $n$  is associated with CIC  $m+n$ , where  $m$  is the CIC contained in the message. {"where  $m$  is the CIC identified in the associated Circuit Identity Code Information Element in the message"}.

Status bit  $n$  is located in bit position  $nb$  of the  $no$ -th octet of the Status subfield with:

- $nb = (n \bmod 8) + 1$ ; and
- $no = (n \div 8) + 1$ .

The number of relevant Status bits in a given Status subfield is equal to the range value +1.

The Status bits are coded as follows:

- in the CIRCUIT GROUP BLOCK message:
  - 0 no indication.
  - 1 block.
- in the CIRCUIT GROUP BLOCKING ACKNOWLEDGE message:
  - 0 no indication.
  - 1 blocking acknowledgement.
- in the CIRCUIT GROUP UNBLOCK message:
  - 0 no indication.
  - 1 unblock.
- in the CIRCUIT GROUP UNBLOCKING ACKNOWLEDGE message:
  - 0 no indication.
  - 1 unblocking acknowledgement.
- in the UNEQUIPPED CIRCUIT message:
  - 0 no indication.
  - 1 unequipped.

### 3.2.2.32 Diagnostics

8	7	6	5	4	3	2	1	
Element identifier								octet 1
Length								octet 2
Error pointer								octet 3-4
Message received								octet 5-n

The coding of the error pointer field is as follows:

Octet 3 gives the number of octets between octet 4 (not included) and the first octet (included) of the part of the message received which provoked the error. Thus:

0000 0000	Error location not determined
0000 0001	The first octet of the message received (i.e. the message type) was found erroneous (unknown)
0000 0010	The second octet of the message received was found erroneous
0000 0011	The third octet of the message received was found erroneous
etc.	

The last three values are reserved for the BSSAP header:

1111 1101	The first octet of the BSSAP header (Discrimination) was found erroneous
-----------	--

1111 1110 (DTAP only) The DLCI (second) octet of the BSSAP header was found erroneous  
 1111 1111 The last octet of the BSSAP header (length indicator) was found erroneous

Octet 4 is coded as follows:

bit	8	7	6	5	4	3	2	1
	0	0	0	0	bit pointer			
	spare							

The bit pointer field is coded as follows:

bits

**4321**

0000 No particular part of the octet is indicated  
 0001 An error was provoked by the field whose most significant bit is in bit position 1  
 0010 An error was provided by the field whose most significant bit is in bit position 2  
 0011 An error was provided by the field whose most significant bit is in bit position 3  
 0100 An error was provided by the field whose most significant bit is in bit position 4  
 0101 An error was provided by the field whose most significant bit is in bit position 5  
 0110 An error was provided by the field whose most significant bit is in bit position 6  
 0111 An error was provided by the field whose most significant bit is in bit position 7  
 1000 An error was provided by the field whose most significant bit is in bit position 8

All other values are reserved.

The "message received" field should be the contents, as far as can be determined, of the received message which provoked the error.

### 3.2.2.33 Chosen Channel

This Information Element contains a description of the channel allocated to the MS.

For VGCS/VBS calls this Information Element contains a description of the channel allocated for the call in the cell.

It is coded as follows:

8	7	6	5	4	3	2	1	
Element identifier								octet 1
Channel mode				Channel				octet 2

The channel mode field is coded as follows:

Bit

**8765**

**meaning**  
 0000 no channel mode indication  
 1001 speech (full rate or half rate)  
 1110 data, 14.5 kbit/s radio interface rate  
 1011 data, 12.0 kbit/s radio interface rate  
 1100 data, 6.0 kbit/s radio interface rate  
 1101 data, 3.6 kbit/s radio interface rate  
 1000 signalling only  
 0001 data, 29.0 kbit/s radio interface rate  
 0010 data, 32.0 kbit/s radio interface rate  
 0011 data, 43.5 kbit/s radio interface rate  
 0100 data, 43.5 kbit/s downlink and 14.5 kbit/s uplink  
 0101 data, 29.0 kbit/s downlink and 14.5 kbit/s uplink  
 0110 data, 43.5 kbit/s downlink and 29.0 kbit/s uplink  
 0111 data, 14.5 kbit/s downlink and 43.5 kbit/s uplink  
 1010 data, 14.5 kbit/s downlink and 29.0 kbit/s uplink  
 1111 data, 29.0 kbit/s downlink and 43.5 kbit/s uplink

All other values are reserved.

The channel field is coded as follows:

Bit	4321	meaning
0000		None (see note)
0001		SDCCH
1000		1 Full rate TCH
1001		1 Half rate TCH
1010		2 Full Rate TCHs
1011		3 Full Rate TCHs
1100		4 Full Rate TCHs
1101		5 Full Rate TCHs
1110		6 Full Rate TCHs
1111		7 Full Rate TCHs
0100		8 Full Rate TCHs

NOTE: This value may be returned in the chosen channel information for VGCS/VBS calls in the case where the BSS has decided to de-allocate resources or allocate no resources for the call.

All other values are reserved.

### 3.2.2.34 Cipher Response Mode

This information element is used by the MSC to indicate whether the IMEI is to be included in the CIPHERING MODE COMPLETE message to be sent by the Mobile Station.

8	7	6	5	4	3	2	1	
Element identifier								octet 1
Cipher response mode								octet 2

Octet 2 is coded as:

Bits 8, 7, 6, 5, 4, 3, 2 - Spare;

Bit 1 = 0 - IMEISV must not be included by the Mobile Station;

Bit 1 = 1 - IMEISV must be included by the Mobile Station.

### 3.2.2.35 Layer 3 Message Contents

This is a variable length element used to pass the contents (from octet 3 up to the last octet) of radio interface messages from one network entity to another.

8	7	6	5	4	3	2	1	
Element identifier								octet 1
Length								octet 2
Layer 3 message contents								octet 3-n

The length indicator (octet 2) is a binary number indicating the absolute length of the contents after the length indicator octet.

Octet j (j = 3, 4, ..., n) is the unchanged octet j of a radio interface layer 3 message as defined in 3GPP TS 24.008, n is equal to the length of that radio interface layer 3 message.

### 3.2.2.36 Channel Needed

This information element contains an indication for the mobile station of which channel is needed for the transaction linked to the paging procedure.

It is coded as follows:

8	7	6	5	4	3	2	1
Element identifier							
Spare						Channel	

octet 1  
octet 2

The Channel field is coded as follows:

Bit	<b>2 1</b>	
	0 0	Any channel
	0 1	SDCCH
	1 0	TCH/F (Full rate)
	1 1	TCH/H or TCH/F (Dual rate)

### 3.2.2.37 Trace Type

A fixed length element indicating the type of trace information to be recorded.

8	7	6	5	4	3	2	1
Element identifier							
Trace type							

octet 1  
octet 2

Octet 2 contains the trace type.

Octet 2 is coded as the MSC/BSS Trace Type specified in 3GPP TS 52.008.

### 3.2.2.38 TriggerID

A variable length element indicating the identity of the entity which initiated the trace.

8	7	6	5	4	3	2	1
Element identifier							
Length							
Entity identity							

octet 1  
octet 2  
octets 3-22

Octets 3-22 may be typically an OMC identity.

### 3.2.2.39 Trace Reference

A fixed length element providing a trace reference number allocated by the triggering entity.

8	7	6	5	4	3	2	1
Element identifier							
TraceReference							

octet 1  
octet 2-3

### 3.2.2.40 TransactionID

A potentially variable length element indicating a particular transaction within a trace.

8	7	6	5	4	3	2	1
Element identifier							
Length							
Transaction number							

octet 1  
octet 2  
octet 3-4

### 3.2.2.41 Mobile Identity

A variable length element.

8	7	6	5	4	3	2	1	
Element identifier								octet 1
Length								octet 2
Mobile identity								octet 3-n

Octet 3-n contain either the IMSI, IMEISV or IMEI as coded in 3GPP TS 24.008, not including 3GPP TS 24.008 element identifier or 3GPP TS 24.008 octet length value.

### 3.2.2.42 OMCID

A variable length element indicating the destination OMC to which trace information is to be sent.

8	7	6	5	4	3	2	1	
Element identifier								octet 1
Length								octet 2
OMC identity								octets 3-22
NOTE: For the OMC identity, see 3GPP TS 52.021.								

### 3.2.2.43 Forward Indicator

A fixed length element indicating whether the trace is to be continued in a BSS to which the call has been handed over.

8	7	6	5	4	3	2	1	
Element identifier								octet 1
spare				Forward indicator				octet 2

Octet 2 is coded as follows:

bit	<b>4 3 2 1</b>	
	0 0 0 1	forward to subsequent BSS, no trace at MSC
	0 0 1 0	forward to subsequent BSS, and trace at MSC

All other values are reserved.

Bits 5-8 are spare.

### 3.2.2.44 Chosen Encryption Algorithm

This element indicates the encryption algorithm being used by the BSS.

It is coded as follows:

8	7	6	5	4	3	2	1	
Element identifier								octet 1
Algorithm identifier								octet 2

The algorithm identifier caters for the possible future introduction of different user data encryption algorithms. It is coded as:

- 0000 0001 No encryption used
- 0000 0010 GSM user data encryption version 1(A5/1).
- 0000 0011 GSM A5/2
- 0000 0100 GSM A5/3
- 0000 0101 GSM A5/4
- 0000 0110 GSM A5/5
- 0000 0111 GSM A5/6
- 0000 1000 GSM A5/7

All other values are Reserved for future international use.

### 3.2.2.45 Circuit Pool

This element indicates the circuit pool of a circuit or group of circuits.

It is coded as follows:

8	7	6	5	4	3	2	1	octet 1 octet 2
Element identifier								
Circuit pool number								

Predefined circuit pools are currently Circuit pool number 1 to Circuit pool number 50.



The circuit pool element is coded as follows (along with the definition of the predefined circuit pools):

<b>Coding</b>	<b>Pool</b>	<b>Supported channels and speech coding algorithms</b>
0000 0001	Circuit pool number 1	FR speech version 1 FR data (12, 6, 3.6 kbit/s)
0000 0010	Circuit pool number 2	HR speech version 1 HR data (6, 3.6 kbit/s)
0000 0011	Circuit pool number 3	FR speech version 1 FR data (12, 6, 3.6 kbit/s) HR speech version 1 HR data (6, 3.6 kbit/s)
0000 0100	Circuit pool number 4	FR speech version 2 FR data (12, 6, 3.6 kbit/s)
0000 0101	Circuit pool number 5	FR speech version 1 FR speech version 2 FR data (12, 6, 3.6 kbit/s)
0000 0110	Circuit pool number 6	FR speech version 2 FR data (12, 6, 3.6 kbit/s) HR speech version 1 HR data (6, 3.6 kbit/s)
0000 0111	Circuit pool number 7	FR speech version 1 FR speech version 2 FR data (12, 6, 3.6 kbit/s) HR speech version 1 HR data (6, 3.6 kbit/s)
0000 1000	Circuit pool number 8	HSCSD max 2 x FR data (12, 6 kbit/s)
0000 1001	Circuit pool number 9	FR data (12, 6, 3.6 kbit/s) HR data (6, 3.6 kbit/s) HSCSD max 2 x FR data (12, 6 kbit/s)
0000 1010	Circuit pool number 10	FR speech version 1 FR speech version 2 FR data (12, 6, 3.6 kbit/s) HR speech version 1 HR data (6, 3.6 kbit/s) HSCSD max 2 x FR data (12, 6 kbit/s)
0000 1011	Circuit pool number 11	HSCSD max 4 x FR data (12, 6 kbit/s)
0000 1100	Circuit pool number 12	FR data (12, 6, 3.6 kbit/s) HR data (6, 3.6 kbit/s) HSCSD max 4 x FR data (12, 6 kbit/s)
0000 1101	Circuit pool number 13	FR speech version 1 FR speech version 2 FR data (12, 6, 3.6 kbit/s) HR speech version 1 HR data (6, 3.6 kbit/s) HSCSD max 4 x FR data (12, 6 kbit/s)
0000 1110	Circuit pool number 14	HSCSD max 6 x FR data (12, 6 kbit/s) EDGE max 2 x FR data (32.0 kbit/s)
0000 1111	Circuit pool number 15	FR data (14.5 kbit/s)
0001 0000	Circuit pool number 16	HSCSD max 2 x FR data (14.5 kbit/s) EDGE FR data (29.0 kbit/s)
0001 0001	Circuit pool number 17	HSCSD max 4 x FR data (14.5 kbit/s) EDGE max 2 x FR data (29.0 kbit/s) EDGE FR data (43.5 kbit/s)
0001 0010	Circuit pool number 18	FR data (14.5, 12, 6, 3.6 kbit/s) HR data (6, 3.6 kbit/s) HSCSD max 2 x FR data (14.5, 12, 6 kbit/s) EDGE FR data (29.0 kbit/s)
0001 0011	Circuit pool number 19	FR data (14.5, 12, 6, 3.6 kbit/s) HR data (6, 3.6 kbit/s) HSCSD max 4 x FR data (14.5, 12, 6 kbit/s) EDGE max 2 x FR data (29.0 kbit/s) EDGE FR data (43.5 kbit/s)
0001 0100	Circuit pool number 20	FR speech version 1 FR speech version 2 FR data (14.5, 12, 6, 3.6 kbit/s) HR speech version 1 HR data (6, 3.6 kbit/s)

<b>Coding</b>	<b>Pool</b>	<b>Supported channels and speech coding algorithms</b>
0001 0101	Circuit pool number 21	FR speech version 1 FR speech version 2 FR data (14.5, 12, 6, 3.6 kbit/s) HR speech version 1 HR data (6, 3.6 kbit/s) HSCSD max 2 x FR data (14.5, 12, 6 kbit/s) EDGE FR data (29.0 kbit/s)
0001 0110	Circuit pool number 22	FR speech version 1 FR speech version 2 FR data (14.5, 12, 6, 3.6 kbit/s) HR speech version 1 HR data (6, 3.6 kbit/s) HSCSD max 4 x FR data (14.5, 12, 6 kbit/s) EDGE max 2 x FR data (29.0 kbit/s) EDGE FR data (43.5 kbit/s)
0001 0111	Circuit pool number 23	FR speech version 3 HR speech version 3
0001 1000	Circuit pool number 24	FR speech version 3 FR data (12, 6, 3.6 kbit/s) HR speech version 3
0001 1001	Circuit pool number 25	FR speech version 1 FR speech version 2 FR speech version 3 FR data (12, 6, 3.6 kbit/s) HR speech version 3 HR speech version 6
0001 1010	Circuit pool number 26	FR speech version 1 FR speech version 2 FR speech version 3 FR data (14.5, 12, 6, 3.6 kbit/s) HR speech version 3 HR speech version 6
0001 1011	Circuit pool number 27	FR speech version 1 FR speech version 2 FR speech version 3 FR data (12, 6, 3.6 kbit/s) HR speech version 1 HR speech version 3 HR speech version 6 HR data (6, 3.6 kbit/s)
0001 1100	Circuit pool number 28	FR speech version 1 FR speech version 2 FR speech version 3 FR data (14.5, 12, 6, 3.6 kbit/s) HR speech version 1 HR speech version 3 HR speech version 6 HR data (6, 3.6 kbit/s)
0001 1101	Circuit pool number 29	FR speech version 1 FR speech version 2 FR speech version 3 FR data (12, 6, 3.6 kbit/s) HR speech version 1 HR speech version 3 HR speech version 6 HR data (6, 3.6 kbit/s) HSCSD max 2 x FR data (12, 6 kbit/s)
0001 1110	Circuit pool number 30	FR speech version 1 FR speech version 2 FR speech version 3 FR data (14.5, 12, 6, 3.6 kbit/s) HR speech version 1 HR speech version 3 HR speech version 6 HR data (6, 3.6 kbit/s) HSCSD max 2 x FR data (14.5, 12, 6 kbit/s) EDGE FR data (29.0 kbit/s)

<b>Coding</b>	<b>Pool</b>	<b>Supported channels and speech coding algorithms</b>
0001 1111	Circuit pool number 31	FR speech version 1 FR speech version 2 FR speech version 3 FR data (12, 6, 3.6 kbit/s) HR speech version 1 HR speech version 3 HR speech version 6 HR data (6, 3.6 kbit/s) HSCSD max 4 x FR data (12, 6 kbit/s)
0010 0000	Circuit pool number 32	FR speech version 1 FR speech version 2 FR speech version 3 FR data (14.5, 12, 6, 3.6 kbit/s) HR speech version 1 HR speech version 3 HR speech version 6 HR data (6, 3.6 kbit/s) HSCSD max 4 x FR data (14.5, 12, 6 kbit/s) EDGE max 2 x FR data (29.0 kbit/s) EDGE FR data (43.5 kbit/s)
0010 0001	Circuit pool number 33	FR data (14.5, 12, 6, 3.6 kbit/s) HR data (6, 3.6 kbit/s) HSCSD max 4 x FR data (14.5, 12, 6 kbit/s) EDGE max 2 x FR data (29.0 kbit/s) EDGE FR data (43.5 kbit/s) EDGE max 2 x FR data (32.0 kbit/s)
0010 0010	Circuit pool number 34	FR speech version 1 FR speech version 2 FR data (14.5, 12, 6, 3.6 kbit/s) HR speech version 1 HR data (6, 3.6 kbit/s) HSCSD max 4 x FR data (14.5, 12, 6 kbit/s) EDGE max 2 x FR data (29.0 kbit/s) EDGE FR data (43.5 kbit/s) EDGE max 2 x FR data (32.0 kbit/s)
0010 0011	Circuit pool number 35	FR speech version 1 FR speech version 2 FR speech version 3 FR data (14.5, 12, 6, 3.6 kbit/s) HR speech version 1 HR speech version 3 HR speech version 6 HR data (6, 3.6 kbit/s) HSCSD max 4 x FR data (14.5, 12, 6 kbit/s) EDGE max 2 x FR data (29.0 kbit/s) EDGE FR data (43.5 kbit/s) EDGE max 2 x FR data (32.0 kbit/s)
0010 0100	Circuit pool number 36	FR speech version 4 FR speech version 5 HR speech version 4
0010 0101	Circuit pool number 37	FR speech version 3 FR speech version 4 FR speech version 5 HR speech version 3 HR speech version 4 HR speech version 6
0010 0110	Circuit pool number 38	FR speech version 1 FR speech version 2 FR speech version 3 FR speech version 4 FR speech version 5 FR data (14.5, 12, 6, 3.6 kbit/s) HR speech version 3 HR speech version 4 HR speech version 6

<b>Coding</b>	<b>Pool</b>	<b>Supported channels and speech coding algorithms</b>
0010 0111	Circuit pool number 39	FR speech version 1 FR speech version 2 FR speech version 3 FR speech version 4 FR speech version 5 FR data (14.5, 12, 6, 3.6 kbit/s) HR speech version 1 HR speech version 3 HR speech version 4 HR speech version 6 HR data (6, 3.6 kbit/s) HSCSD max 2 x FR data (14.5, 12, 6 kbit/s) EDGE FR data (29.0 kbit/s)
0010 1000	Circuit pool number 40	FR speech version 1 FR speech version 2 FR speech version 3 FR speech version 4 FR speech version 5 FR data (14.5, 12, 6, 3.6 kbit/s) HR speech version 1 HR speech version 3 HR speech version 4 HR speech version 6 HR data (6, 3.6 kbit/s) HSCSD max 4 x FR data (14.5, 12, 6 kbit/s) EDGE max 2 x FR data (29.0 kbit/s) EDGE FR data (43.5 kbit/s)
0010 1001	Circuit pool number 41	FR speech version 1 FR speech version 2 FR speech version 3 FR speech version 4 FR speech version 5 FR data (14.5, 12, 6, 3.6 kbit/s) HR speech version 1 HR speech version 3 HR speech version 4 HR speech version 6 HR data (6, 3.6 kbit/s) HSCSD max 4 x FR data (14.5, 12, 6 kbit/s) EDGE max 2 x FR data (29.0 kbit/s) EDGE FR data (43.5 kbit/s) EDGE max 2 x FR data (32.0 kbit/s)
0010 1010	Circuit pool number 42	FR speech version 1 + CTM
0010 1011	Circuit pool number 43	FR speech version 2 + CTM
0010 1100	Circuit pool number 44	FR speech version 1 + CTM FR speech version 2 + CTM
0010 1101	Circuit pool number 45	FR speech version 1 + CTM FR speech version 2 + CTM HR speech version 1 + CTM
0010 1110	Circuit pool number 46	FR speech version 3 + CTM HR speech version 3 + CTM HR speech version 6 + CTM
0010 1111	Circuit pool number 47	FR speech version 1 + CTM FR speech version 2 + CTM FR speech version 3 + CTM HR speech version 3 + CTM HR speech version 6 + CTM
0011 0000	Circuit pool number 48	FR speech version 1 + CTM FR speech version 2 + CTM FR speech version 3 + CTM HR speech version 1 + CTM HR speech version 3 + CTM HR speech version 6 + CTM
0011 0001	Circuit pool number 49	FR speech version 3 HR speech version 3 HR speech version 6

Coding	Pool	Supported channels and speech coding algorithms
0011 0010	Circuit pool number 50	FR speech version 3 FR data (12, 6, 3.6 kbit/s) HR speech version 3 HR speech version 6
1000 xxxx	For national/local use	
		All other values are reserved for future international use

### 3.2.2.46 Circuit Pool List

This element defines a list of BSS preferred circuit pools in order of preference.

It is coded as follows:

8	7	6	5	4	3	2	1	
Element identifier								octet 1
Length								octet 2
Circuit pool number (1st preferred)								octet 3
⋮								⋮
Circuit pool number (nth preferred)								octet n+2

The Circuit pool number is coded as specified in sub-clause 3.2.2.45.

### 3.2.2.47 Time Indication

This element defines the period where the information shall be valid. It is fixed length, 2 octets.

The coding is as follows:

8	7	6	5	4	3	2	1	
Element identifier								octet 1
Time								octet 2

The Time field of this Information Element message in octet 2 is coded as follows:

```

0000 0000    (note)
0000 0001
:
1111 1110    Time,
```

where the time is the binary value of octet 2 x 10 s (ie 10 s to 2 540 s).

If the Time field contains the value 255 (1111 1111), the receiving entity shall consider the time as infinite.

NOTE: The value 0 has a special meaning in the Load indication procedure (refer to sub-clause 3.1.20).

### 3.2.2.48 Resource Situation

This element gives, for respective indicated channel type, the total number of channels accessible and the number of channels available on any given cell at the time of construction of the message.

The number of channels available may be defined in up to five interference bands, the boundaries of these bands being set by O and M as follows:

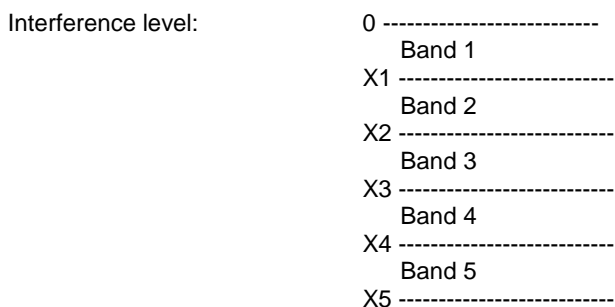

The element is coded as follows:

8	7	6	5	4	3	2	1	
Element identifier								octet 1
Length								octet 2
Resource and interference band indicator				Channel type				octet 3
7/15 ind.	Number of channels							octet 4
Resource and interference band indicator								octet 4a
Resource and interference band indicator				Channel type				octet 5
7/15 ind.	Number of channels							octet 6
Resource and interference band indicator								octet 6a
Resource and interference band indicator								octet N-1
Resource and interference band indicator				Channel type				octet N
7/15 ind.	Number of channels							octet Na

The length indicator is a binary representation of the length of the following element.

The Resource type octet (octets 3, 5, etc.) is coded as follows:

The Channel type field (bits 1-4 of octets 3, 5, etc.) is coded as follows:

Bit	
<b>4 3 2 1</b>	<b>meaning</b>
0 0 0 1	SDCCH
1 0 0 0	Full Rate TCH
1 0 0 1	Half Rate TCH
All other values are reserved.	

The Resource and interference band indicator field (bits 5-8 of octets 3, 5, etc.) is coded as follows:

Bit	
<b>8 7 6 5</b>	<b>meaning</b>
0 0 0 0	Total number of channels accessible (i.e. available for service or currently assigned)
0 0 0 1	Number of channels available in interference band 1
0 0 1 0	Number of channels available in interference band 2
0 0 1 1	Number of channels available in interference band 3
0 1 0 0	Number of channels available in interference band 4
0 1 0 1	Number of channels available in interference band 5
1 1 1 0	Number of channels available without supplied interference band classification

All other values are reserved.

The Number of channels octets (octets 4, 6, etc.) is coded as follows:

The Number of channels is a single octet element if the 7/15 indication bit (bit 8 of octets 4, 6, etc.) is set to 0. If the 7/15 indication bit is set to 1 then it is a 2 octet field. It give a 7 (or 15) bit binary representation of the number of channels with resource type as indicated in the nearest preceding resource type octet. The coding convention used when a field extends over more than one octet is defined in sub-clause 3.2.2.

The number of half rate channels will include half rate channels counted as full rate channels, if these correspond to full rate channels that can be used as half rate channels.

(e.g. If there is one idle half rate channel and one idle full rate channel that can be used as two half rate channels, then the full rate count will be 1 and the half rate count will be 3).

The Resource type octet and the Number of channels octet(s) are repeated for each of the resource type reported.

For each of the channel type reported, the total number of channels accessible and at least one indication of available channels shall be included.

The number of channels available without supplied interference band classification is included only in case the interference band definition is not available for the reported channel type.

### 3.2.2.49 Current Channel Type 1

This Information Element contains a description of the channel allocated to the MS.

It is coded as follows:

8	7	6	5	4	3	2	1	
Element identifier								octet 1
Channel mode				Channel				octet 2

The channel mode field is coded as follows:

Bit	meaning
<b>8765</b>	
0000	signalling only
0001	speech (full rate or half rate)
0110	data, 14.5 kbit/s radio interface rate
0011	data, 12.0 kbit/s radio interface rate
0100	data, 6.0 kbit/s radio interface rate
0101	data, 3.6 kbit/s radio interface rate
0111	data, 29 kbit/s radio interface rate
1000	data, 32 kbit/s radio interface rate
1001	data, 43.5 kbit/s radio interface rate
0010	data, 43.5 kbit/s downlink and 14.5 kbit/s uplink
1010	data, 29.0 kbit/s downlink and 14.5 kbit/s uplink
1011	data, 43.5 kbit/s downlink and 29.0 kbit/s uplink
1100	data, 14.5 kbit/s downlink and 43.5 kbit/s uplink
1101	data, 14.5 kbit/s downlink and 29.0 kbit/s uplink
1110	data, 29.0 kbit/s downlink and 43.5 kbit/s uplink
1111	is reserved

All other values are for future use. If the receiver receives an unknown channel mode it shall not be rejected but the receiver shall assume that the channel mode is to be changed.

The channel field is coded as follows:

Bit	meaning
4321	SDCCH
0001	1 Full rate TCH
1000	1 Half rate TCH
1001	2 Full Rate TCHs
1010	3 Full Rate TCHs
1011	4 Full Rate TCHs
1100	5 Full Rate TCHs
1101	6 Full Rate TCHs
1110	7 Full Rate TCHs
1111	8 Full Rate TCHs
0100	is reserved
0000	is reserved

All other values are for future use. If the receiver receives a unknown channel field it shall not be rejected but the receiver shall assume that the channel is to be changed.

Consistencies between channel fields and channel modes shall not be checked.

### 3.2.2.50 Queuing Indicator

This element contains a recommendation of the BSS concerning application of queuing.

The element has a fixed length of two octets.

8	7	6	5	4	3	2	1	
Element identifier								octet 1
spare						qri	spare	octet 2

Octet 2 is coded as follows:

qri = queuing recommendation indicator

0	it is recommended not to allow queuing
1	it is recommended to allow queuing

### 3.2.2.51 Speech Version

This element indicates the speech version being used by the BSS.

It is coded as follows:

8	7	6	5	4	3	2	1	
Element identifier								octet 1
spare	Speech version identifier							octet 2

The bits 7-1 of octet 2 are coded in the same way as the permitted speech version identifier in the Channel type information element.

### 3.2.2.52 Assignment Requirement

8	7	6	5	4	3	2	1	
Element identifier								octet 1
Assignment requirement								octet 2



Octet 2

00000000 Delay allowed.  
 00000001 Immediate and the resources shall not be de-allocated until the end of the call (channel establishment on demand forbidden by the MSC).  
 00000010 Immediate and the resources may further be de-allocated by the BSS (channel establishment on demand permitted by the MSC).  
 All other values are reserved.

### 3.2.2.53 (void)

### 3.2.2.54 Talker Flag

8	7	6	5	4	3	2	1
Element identifier							

octet 1

### 3.2.2.55 Group Call Reference

It is coded as follows:

8	7	6	5	4	3	2	1
Element identifier							
Length							
Descriptive group or broadcast call reference							

octet 1  
 octet 2  
 octets 3-7

Octet 2 is a binary indication of the length of the remainder of the element in octets.

The octets 3-7 are coded in the same way as the octets 2-6 in the Descriptive group or broadcast call reference information element as defined in 3GPP TS 24.008.

### 3.2.2.56 eMLPP Priority

This Information Element contains the eMLPP priority of the call.

It is coded as follows:

8	7	6	5	4	3	2	1
Element identifier							
spare				call priority			

octet 1  
 octet 2

The call priority field (bit 3 to 1 of octet 2) is coded in the same way as the call priority field (bit 3 to 1 of octet 5) in the Descriptive group or broadcast call reference information element as defined in 3GPP TS 24.008.

### 3.2.2.57 Configuration Evolution Indication

This information element indicates whether subsequent assignment requests should be expected and the limitation for these subsequent assignments.

8	7	6	5	4	3	2	1
Element identifier							
spare				SMI			
SMI: Subsequent Modification Indication. This indicates the maximum number of TCH/F that could be requested in subsequent assignments.							

octet 1  
 octet 2

The SMI field is coded as follows:

Bit	<b>4321</b>
	0000 No Modification is allowed
	0001 Modification is allowed and maximum number of TCH/F is 1
	0010 Modification is allowed and maximum number of TCH/F is 2
	0011 Modification is allowed and maximum number of TCH/F is 3
	0100 Modification is allowed and maximum number of TCH/F is 4

All other values are reserved.

### 3.2.2.58 Old BSS to New BSS information

This information element is defined as a general container for passing Field Elements transparently from an old BSS/RNC/eNB to a new BSS via the MSC.

These Field Elements are passed in the "Old BSS to New BSS information elements" octets field. The error handling performed by the receiving entity for the "Old BSS to New BSS information elements" field is that specified in sub-clause 3.1.19.7.

8	7	6	5	4	3	2	1	
Element identifier								octet 1
Length								octet 2
Old BSS to New BSS information elements								octet 3-n

The length indicator (octet 2) is a binary number indicating the absolute length of the contents after the length indicator octet and may be set to zero.

The Old BSS to New BSS information elements field is made up of 0 or more Field Elements listed in the table shown below.

Field elements may occur in any order in the Old BSS to New BSS information elements field.

The construction of the Field Elements allows the receiver to ignore unknown Field Elements.

Due to backward compatibility issues Field Elements in the "Old BSS to New BSS information" may duplicate information from Information Elements in the HANDOVER REQUEST, when this occurs and the new BSS detects an inconsistency between this information then the information contained in the "Old BSS to New BSS information" shall take precedence as long as the coding is understood by the new BSS.

Reception of an erroneous "Old BSS to New BSS information" shall not cause a rejection of the HANDOVER REQUEST message; the "Old BSS to New BSS information" information element shall be discarded and the handover resource allocation procedure shall continue.

FIELD ELEMENT	REFERENCE	LEN
Extra information	3.2.3.1	3
Current Channel Type 2	3.2.3.2	4
Target cell radio information	3.2.3.3	3
GPRS Suspend information	3.2.3.4	19
MultiRate configuration information	3.2.3.5	3-8
Dual Transfer Mode information	3.2.3.6	3
Inter RAT Handover Info	3.2.3.7	3-n
cdma2000 Capability Information	3.2.3.8	n
Cell Load Information Group	3.2.3.11	3-n
VGCS talker mode	3.2.2.93	3
PS Indication	3.2.3.13	3
D-RNTI	3.2.3.15	5
IRAT Measurement Configuration	3.2.3.16	3-n

The D-RNTI field element shall only be present when a Radio Resource Reserve Handover procedure is applied over the Iur-g interface (see 3GPP TS 43.130).

## 3.2.2.59 (void)

## 3.2.2.60 LCS QoS

This element indicates the Quality of Service requirements for the location request.

It is coded as follows:

8	7	6	5	4	3	2	1
Element identifier							
Length							
QoS							

octet 1  
octet 2  
octet 3-n

The coding of octet 2 is a binary number indicating the length of the remaining element.

The QoS octets 3 to n are coded in the same way as the equivalent octets in the LCS QoS element of 3GPP TS 49.031.

## 3.2.2.61 LSA Access Control Suppression

This information element is included if LSA access control function shall be suppressed in the BSS.

It is coded as follows:

8	7	6	5	4	3	2	1
Element identifier							
spare							EM

octet 1  
octet 2

If the connection is an emergency call the MSC shall set the emergency field (bit 1 of octet 2) to 1. If the emergency field is set to 1, the BSS shall suppress exclusive access, LSA only access and preferential access functionality.

## 3.2.2.62 LCS Priority

The LCS Priority defines the priority of the location request.

It is coded as follows:

8	7	6	5	4	3	2	1
Element identifier							
Length							
Priority							

octet 1  
octet 2  
octet 3-n

The coding of octet 2 is a binary number indicating the length of the remaining element.

The Priority octets 3 to n are coded in the same way as the equivalent octets in the LCS Priority element of 3GPP TS 49.031.

## 3.2.2.63 Location Type

The Location Type information element indicates the type of location request.

It is coded as follows:

8	7	6	5	4	3	2	1
Element identifier							
Length							
Location Type							

octet 1  
octet 2  
octet 3-n

The coding of octet 2 is a binary number indicating the length of the remaining element.

The Location Type octets 3 to n are coded in the same way as the equivalent octets in the Location Type element of 3GPP TS 49.031.

### 3.2.2.64 Location Estimate

This is a variable length information element providing an estimate of a geographic location of a target MS.

It is coded as follows:

8	7	6	5	4	3	2	1	
Element identifier								octet 1
Length								octet 2
Location estimate								octet 3-n

The length indicator is a binary indication of the number of octets following in the element.

The Location Estimate field is composed of 1 or more octets with an internal structure according to 3GPP TS 23.032.

### 3.2.2.65 Positioning Data

This element indicates the data on the positioning process for possible use in billing in location method evaluation.

It is coded as follows:

8	7	6	5	4	3	2	1	
Element identifier								octet 1
Length								octet 2
Positioning data								octet 3-n

The coding of octet 2 is a binary number indicating the length of the remaining element.

The Positioning Data octets 3 to n are coded in the same way as the equivalent octets in the Positioning Data element of 3GPP TS 49.031.

### 3.2.2.66 LCS Cause

This element indicates the data on the positioning process for possible use in billing in location method evaluation.

It is coded as follows:

8	7	6	5	4	3	2	1	
Element identifier								octet 1
Length								octet 2
LCS Cause								octet 3-n

The coding of octet 2 is a binary number indicating the length of the remaining element.

The LCS Cause octets 3 to n are coded in the same way as the equivalent octets in the LCS Cause element of 3GPP TS 49.031.

### 3.2.2.67 LCS Client Type

This element identifies the type of LCS Client.

It is coded as follows:

8	7	6	5	4	3	2	1	
Element identifier								octet 1
Length								octet 2
LCS Client Type								octet 3-n

The LCS Client Type octets 3 to n are coded in the same way as the equivalent octet in the LCS Client Type element of 3GPP TS 49.031.

### 3.2.2.68 APDU

This information element is defined as a general container for passing information transparently between BSSs or between BSS and SMLC via the MSC.

It is coded as follows:

8	7	6	5	4	3	2	1	
Element identifier								octet 1
Length								octet 2-3
APDU								octet 4-n

The length indicator is a binary indication of the number of octets following in the element.

The APDU octets 4 to n are coded in the same way as the equivalent octet in the APDU element of 3GPP TS 49.031.

### 3.2.2.69 Network Element Identity

This is a variable length information element identifying a network element, by association with either a designated cell site or a designated location area.

It is coded as follows:

8	7	6	5	4	3	2	1	
Element identifier								octet 1
Length								octet 2
Network Element Identity								octet 3-n

The coding of octet 2 is a binary number indicating the length of the remaining element.

The Network Element Identity octets 3 to n are coded in the same way as the equivalent octets in the Network Element Identity element of 3GPP TS 49.031.

### 3.2.2.70 GPS Assistance Data

This is a variable length information element indicating the requested GPS assistance data.

It is coded as follows:

8	7	6	5	4	3	2	1	
Element identifier								octet 1
Length								octet 2
GPS Assistance Data								octet 3-n

The coding of octet 2 is a binary number indicating the length of the remaining element.

The GPS Assistance Data octets 3 to n are coded in the same way as the equivalent octets in the Requested GPS Data element of 3GPP TS 49.031.

### 3.2.2.71 Deciphering Keys

This is a variable length information element indicating the requested GPS assistance data.

It is coded as follows:

8	7	6	5	4	3	2	1	
Element identifier								octet 1
Length								octet 2
Deciphering Keys								octet 3-n

The coding of octet 2 is a binary number indicating the length of the remaining element.

The Deciphering Key octets 3 to n are coded in the same way as the equivalent octets in the Deciphering Key element of 3GPP TS 49.031.

### 3.2.2.72 Return Error Request

This is a variable length information element indicating a request from the source for an error response if the message cannot be delivered to its final destination.

It is coded as follows:

8	7	6	5	4	3	2	1	
Element identifier								octet 1
Length								octet 2
Return Error Type								octet 3-n

The coding of octet 2 is a binary number indicating the length of the remaining element.

The Return Error Type octets from 3 to n are coded in the same way as the equivalent octets in the Return Error Request element of 3GPP TS 49.031.

### 3.2.2.73 Return Error Cause

This is a variable length information element indicating the reason for unsuccessful delivery of a message to its final destination.

It is coded as follows:

8	7	6	5	4	3	2	1	
Element identifier								octet 1
Length								octet 2
Cause Value								octet 3-n

The coding of octet 2 is a binary number indicating the length of the remaining element.

The Cause Value octets from 3 to n are coded in the same way as the equivalent octets in the Return Error Cause element of 3GPP TS 49.031.

### 3.2.2.74 Segmentation

This is a variable length information element containing segmentation and message information for a segmented APDU.

It is coded as follows:

8	7	6	5	4	3	2	1	
Element identifier								octet 1
Length								octet 2
Segmentation and Message Information								octet 3-n

The coding of octet 2 is a binary number indicating the length of the remaining element.

The Segmentation and Message information octets from 3 to n are coded in the same way as the equivalent octets in the Segmentation element of 3GPP TS 49.031.

### 3.2.2.75 Service Handover

The Service Handover defines information to use for handover to UTRAN or cdma2000. It is coded as follows:

8	7	6	5	4	3	2	1	
Element identifier								octet 1
Length								octet 2
Service Handover information								octet 3

Octet 2 is a binary indication of the length of the remainder of the element in octets.

Service Handover information is coded as follows:

Bits 4-8: Spare.

Bits 1 - 3:

3 2 1

- 0 0 0 Handover to UTRAN or cdma2000 should be performed  
Handover to UTRAN or cdma2000 is preferred. The handover evaluation of the target cell for handovers shall take into account the preference for UTRAN or cdma2000.
- 0 0 1 Handover to UTRAN or cdma2000 should not be performed  
Handover to GSM is preferred. The handover evaluation of the target cell for handovers shall take into account the preference for GSM.
- 0 1 0 Handover to UTRAN or cdma2000 shall not be performed  
Handover to UTRAN or cdma2000 is not allowed.

All other values are interpreted as no information available for service based handover.

### 3.2.2.76 Source RNC to target RNC transparent information (UMTS)

This information element is defined as a general container for passing (e.g. UE Capability Information, Target Cell ID) RNC specific information transparently through the core network from BSS to RNC.

8	7	6	5	4	3	2	1	
Element identifier								octet 1
Length								octet 2
Source RNC to target RNC transparent information value								octet 3-n

The Source RNC to Target RNC transparent Information value is encoded as the *Source RNC to Target RNC Transparent Container* IE as defined in relevant RANAP specification 3GPP TS 25.413, excluding RANAP tag.

### 3.2.2.77 Source RNC to target RNC transparent information (cdma2000)

This information element is defined as a general container for passing (e.g. cdma2000 Capability Information, Target Cell ID) RNC specific information transparently through the core network from BSS to RNC.

8	7	6	5	4	3	2	1	
Element identifier								octet 1
Length								octet 2
Source RNC to target RNC transparent information value								octet 3-n

The Source RNC to Target RNC transparent Information value (structure and encoding) for cdma2000 is defined in relevant specifications.

### 3.2.2.78 GERAN Classmark

This information element is used to convey cell related information to the MSC. The GERAN classmark information element is coded as follows:

8	7	6	5	4	3	2	1	
Element identifier								octet 1
Length								octet 2
Codec List								octet 3+n
Spare				Maximum Number of Traffic Channels				Octet n+1
Spare				Acceptable Channel Codings				Octet n+2

The maximum number of traffic channels in octet n+1 specifies the maximum number of traffic channels supported by the serving cell or, in case of handover, by the target cell. The maximum number of traffic channels field in octet n+1 is coded as follows:

bits	meaning
<b>321</b>	
000	1 TCHs
001	2 TCHs
010	3 TCHs
011	4 TCHs
100	5 TCHs
101	6 TCHs

All other values are reserved.

The acceptable channel codings in octet n+2 specifies which channel codings are supported by the serving cell or, in case of handover, by the target cell. The acceptable channel codings field in octet n+2 is coded as follows:

Bit 5:	0	TCH/F43.2 not acceptable
	1	TCH/F43.2 acceptable
Bit 4:	0	TCH/F32 not acceptable
	1	TCH/F32 acceptable
Bit 3:	0	TCH/F28.8 not acceptable
	1	TCH/F28.8 acceptable
Bit 2:	0	TCH/F14.4 not acceptable
	1	TCH/F14.4 acceptable
Bit 1:	0	TCH/F9.6 not acceptable
	1	TCH/F9.6 acceptable

All other values are reserved.

The codec list specifies which codec types are supported by the serving cell or, in case of handover, by the target cell, and is coded as specified in 3GPP TS 26.103, with the following restrictions:

- In case of adaptive multi-rate codecs or adaptive multi-rate wideband codecs, the Active Code Set (ACS) octet(s) is (are) not used and shall be ignored by the MSC.
- The Maximal Number of Codec Modes (MACS), if included, shall be set to four.
- The SCS shall indicate the supported codecs within a GERAN cell in case of an adaptive codec type.

### 3.2.2.79 GERAN BSC Container

This element is used to convey the selected codec type to the BSC. The GERAN BSC Container information element is coded as follows:



8	7	6	5	4	3	2	1		
Element identifier								octet 1	
Length								octet 2	
Codec Type								octet 3	
allowed r i/f rates				Maximum Number of Traffic Channels				octet 4	

The codec type is coded as specified in 3GPP TS 26.103.

For CS Speech services octet 4 shall not be present.

For CS Data services octets 3 and 4 shall be present and the Codec Type "MuMe" (as specified in 3GPP TS 26.103) shall be used.

The allowed radio interface data rates indicates the channel coding which is supported by the MS, BSC and MSC.

Octet 4 shall be coded as follows:

Bits 8 to 4 indicate the allowed radio interface data rate, per channel;

Bit 8:	0	43.5 kbit/s (TCH/F43.2) not allowed
	1	43.5 kbit/s (TCH/F43.2) allowed
Bit 7:	0	32.0 kbit/s (TCH/F32.0) not allowed
	1	32.0 kbit/s (TCH/F32.0) allowed
Bit 6:	0	29.0 kbit/s (TCH/F28.8) not allowed
	1	29.0 kbit/s (TCH/F28.8) allowed
Bit 5:	0	14.5/14.4 kbit/s (TCH/F14.4) not allowed
	1	14.5/14.4 kbit/s (TCH/F14.4) allowed
Bit 4:	0	12.0/9.6 kbit/s (TCH F/9.6) not allowed
	1	12.0/9.6 kbit/s (TCH F/9.6) allowed

In this version of the protocol the MSC shall indicate only one radio interface data rate as allowed.

The Maximum number of traffic channels is the maximum, which is supported by the MS, BSC and MSC.

Bits 3-1 specify the maximum number of traffic channels which the BSS may allocate for the call. The maximum number of traffic channels field is coded as follows:

bits	meaning
000	1 TCHs
001	2 TCHs
010	3 TCHs
011	4 TCHs
100	5 TCHs
101	6 TCHs

All other values are reserved.

### 3.2.2.80 New BSS to Old BSS Information

This information element is defined as a general container for passing field elements transparently between BSSs via the MSC.

These field elements are passed in the *New BSS to Old BSS information elements* field. The error handling performed by the receiving entity for the *New BSS to Old BSS information elements* field is that specified in sub-clause 3.1.19.7.

8	7	6	5	4	3	2	1
Element identifier							
Length							
New BSS to Old BSS information elements							

octet 1  
octet 2  
octet 3-n

The length indicator (octet 2) is a binary number indicating the absolute length of the contents after the length indicator octet and may be set to zero.

The *New BSS to Old BSS information elements* field is made up of 0 or more field elements listed in the table shown below. Field elements may occur in any order in the Old BSS to New BSS information elements field. The construction of the Field Elements allows the receiver to ignore unknown Field Elements.

Reception of an erroneous *New BSS to Old BSS information* IE shall not cause a rejection of the HANDOVER COMMAND or HANDOVER FAILURE messages. In that case, the *New BSS to Old BSS information* IE shall be discarded and the handover procedure shall continue.

FIELD ELEMENT	REFERENCE	LEN
Downlink Cell Load Information	3.2.3.9	6
Uplink Cell Load Information	3.2.3.10	6
DTM Handover Command Indication	3.2.3.14	3

The DTM Handover Command Indication field element shall be included in this information element if the *Layer 3 Information IE* included in a (BSSMAP) HANDOVER REQUEST ACKNOWLEDGE message or (BSSMAP) HANDOVER COMMAND message contains an (RLC/MAC) DTM HANDOVER COMMAND message.

### 3.2.2.81 Inter-System Information

This information element is defined as a general container for passing RNC specific information transparently through the core network from a BSS to an RNC.

8	7	6	5	4	3	2	1
Element identifier							
Length							
Inter-System Information Transparent Container							

octet 1  
octet 2  
octet 3-n

The container structure and encoding of the *Inter-System Information Transparent Container* is defined in the RANAP specification (see 3GPP TS 25.413), excluding the RANAP tag.

### 3.2.2.82 SNA Access Information

This element identifies the Shared Network Areas (SNA(s)) the UE is authorised to access.

8	7	6	5	4	3	2	1
Element identifier							
Length							
Authorised PLMN 1 (1 <sup>st</sup> octet of Authorised PLMN 1)							
⋮							
Authorised PLMN n (last octet of Authorised PLMN n)							

Octet 1  
Octet 2  
Octet 3  
.. to  
 $2 + \sum_{i=1}^n (4 + 2m_i)$

Where  $m_i$  is the number of Authorised SNAs in the  $i^{th}$  Authorized PLMN.

$m_i = 0 \dots m$  and may be different in all Authorized PLMNs.

Note that if  $n = 1$ ,  $0 \leq m_i \leq 125$ .

The coding of octet 2 is a binary number indicating the length of the remaining element. The length depends on the number of Authorised PLMNs to be identified.

Coding of the i-th Authorised PLMN:

8	7	6	5	4	3	2	1	
Length of Authorised PLMN i								Octet 1
MCC dig 2				MCC dig 1				Octet 2
MNC dig 3				MCC dig 3				Octet 3
MNC dig 2				MNC dig 1				Octet 4
Authorised SNA 1								Octet 5
Authorised SNA 1 (cont.)								Octet 6
⋮								
Authorised SNA m								... to 4 + (2m - 1)
Authorised SNA m (cont.)								... to 4 + 2m

The coding of octet 1 is a binary number indicating the length of the Authorised PLMN<sub>i</sub>. The length of the Authorised PLMN<sub>i</sub> depends on the number of Authorised SNAs to be identified.

The octet 3 bits 5-8 are filled with "1111" if 2 digit MNC is used.

The Authorised PLMN<sub>i</sub> contains at least the PLMN identity (octets 2 - 4) of the Authorised PLMN<sub>i</sub>. The octets 2 - 4 of the Authorised PLMN<sub>i</sub> are coded as octets 2 - 4 shown in 3GPP TS 24.008 [6], Table 'Location Area Identification information element'. Authorised PLMN<sub>i</sub> may also include 0 to m Authorised SNAs.

Coding of the Authorised SNA:

8	7	6	5	4	3	2	1	
SNAC								Octet 1
SNAC cont.								Octet 2

The Shared Network Area Code (SNAC) in octets 1 - 2 is coded as specified in 3GPP TS 23.003 [2]. The least significant bit of SNAC is octet 2 bit 1 and most significant bit is octet 1 bit 8.

### 3.2.2.83 VSTK\_RAND Information

This element contains the VSTK\_RAND that is to be used to generate the short term ciphering keys for the given group call. The VSTK\_RAND is defined in 3GPP TS 43.020.

8	7	6	5	4	3	2	1	
Element identifier								Octet 1
Length								Octet 2
VSTK_RAND								Octet 3
⋮								Octet 4
⋮								
				spare				Octet 7

Octet 2 is a binary indication of the length of the remainder of the element in octets.

The length of the VSTK\_RAND is 36 bits and it is encoded in octets 3,4,5,6 and bits 8 to 5 of octet 7. Bit 8 of octet 3 contains the most significant bit of VSTK\_RAND, and bit 5 of octet 7 the least significant bit

### 3.2.2.84 VSTK information

This element contains the short term key VSTK that is to be used to generate the VGCS ciphering keys for the given group call. The short term key VSTK is defined in 3GPP TS 43.020.

8	7	6	5	4	3	2	1	
Element identifier								Octet 1
Length								Octet 2
VSTK								Octet 3
⋮								
⋮								
⋮								Octet 18

Octet 2 is a binary indication of the length of the remainder of the element in octets.

The length of the VSTK is 128 bits and it is encoded in octets 3-18. Bit 8 of octet 3 contains the most significant bit of VSTK, and bit 1 of octet 18 the least significant bit

### 3.2.2.85 Paging Information

This information element is included if the MSC has some extra information on how to perform the paging.

It is coded as follows:

8	7	6	5	4	3	2	1	
Element identifier								octet 1
spare				Paging Cause			VGCS /VBS	octet 2

If the VGCS/VBS flag is set to zero, the mobile station to be paged is not a member of any VGCS/VBS-group. If the VGCS/VBS flag is set to one, the mobile station to be paged is a member of a VGCS/VBS-group.

For mobile stations that are members of at least one VBS/VGCS group (i.e. bit 1 of octet 2 is set to 1), the paging cause indicates whether the paging is for a mobile terminating call, USSD or a short message. The paging cause is coded as follows.

Bit	
<b>3 2</b>	
0 0	Paging is for mobile terminating call
0 1	Paging is for a short message
1 0	Paging is for a USSD
1 1	Spare

### 3.2.2.86 IMEI

This information element identifies the International Mobile Station Equipment Identity of the mobile station (see 3GPP TS 23.003).

The element coding is:

8	7	6	5	4	3	2	1	
Element identifier								octet 1
Length								octet 2
IMEI coded as the value part of the <i>Mobile Identity</i> IE defined in 3GPP TS 24.008 (NOTE 1)								octet 3-10
NOTE 1: The <i>Type of identity</i> field in the <i>Mobile Identity</i> IE shall be ignored by the receiver.								

### 3.2.2.87 Velocity Estimate

This is a variable length information element providing an estimate of the speed and bearing of a target MS.

It is coded as follows:

8	7	6	5	4	3	2	1	
Element identifier								octet 1
Length								octet 2
Velocity estimate								octet 3-n

The length indicator is a binary indication of the number of octets following in the element.

The Velocity Estimate field is composed of 1 or more octets with an internal structure according to 3GPP TS 23.032.

### 3.2.2.88 VGCS Feature Flags

This BSSMAP information element is used by the MSC and BSS to indicate the support of some optional features for a VBS or VGCS group call.

The VGCS Feature Flags IE is coded as follows:

8	7	6	5	4	3	2	1	
Element identifier								octet 1
Length								octet 2
Spare		TC P	Bss Res	AS Ind	TP Ind			octet 3

Octet 3 is coded as follows:

Bit 1 is the talker priority indicator (TP Ind).

Bit	
<b>1</b>	
0	Talker Priority not supported
1	Talker Priority supported

Bits 2 and 3 are the A-interface resource sharing indicator (AS Ind).

Bit	
<b>2</b>	
0	No A-interface circuit sharing
1	A-interface circuit sharing

Bit	
<b>3</b>	
0	No A-interface link sharing
1	A-interface link sharing

The BSS shall never set bit 2 and bit 3 to 1. If it does the MSC should clear the call.

Bit 4 is the group or broadcast call re-establishment by the BSS indicator (Bss Res).

Bit	
<b>4</b>	
0	No re-establishment of the group or broadcast call by the BSS
1	Re-establishment of the group or broadcast call by the BSS

The BSS shall only set bit 4 of the VGCS Features Flags IE to 1 in the VGCS/VBS SETUP ACK message if:

- the MSC has also set bit 4 of this IE to 1 in the VGCS/VBS SETUP message, and
- the BSS has also set bit 3 of this IE to 0 in the VGCS/VBS SETUP ACK message

Bit 5 is the Talker Channel Parameter (TCP).

Bit	
<b>5</b>	
0	talker channel parameter is not applicable to this call

- 1 talker channel parameter is applicable to this call, talker shall be established and maintained on a dedicated channel

The BSS shall set bit 5 of the VGCS Flags IE to 1 in the VGCS/VBS SETUP ACK message only if:

- the MSC has also set bit 5 of this IE to 1 in the VGCS/VBS SETUP message, and
- the BSS supports the option of Talker Channel Parameter.

### 3.2.2.89 Talker Priority

This information element contains the talker priority.

It is coded as follows:

8	7	6	5	4	3	2	1
Element identifier							
Spare				Priority			

octet 1  
octet 2

**Table 3.2.2.90.1: Talker Priority information element format**

Priority (octet 2)	
Bits	
2 1	
0 0	Normal Priority
0 1	Privileged Priority
1 0	Emergency Priority
1 1	reserved for future use

### 3.2.2.90 Emergency Set Indication

This information element is included to set the Emergency mode.

It is coded as follows:

8	7	6	5	4	3	2	1
Element identifier							

octet 1

### 3.2.2.91 Talker Identity

This information element contains additional information regarding the identity of the talker.

It is coded as follows:

8	7	6	5	4	3	2	1
Element identifier							
Length							
spare				Filler Bits			
Talker Identity field							

Octet 1  
Octet 2  
Octet 3  
Octet 4-20

Octet 3 is coded as follows:

- Filler Bits (Bits 1-3). This field contains the binary representation of the number of unused bits in the last octet of the Talker Identity field. The filler bits are situated in the val(Filler Bits) least significant bits of the last octet of the Talker Identity field;
- Bits 4 to 8 are spareOctets 4, etc. contain the Talker Identity field. Bit 8 of octet 4 contains the most significant bit.

### 3.2.2.92 SMS to VGCS

This information element contains a short message for the on going VGCS group call.

It is coded as follows:

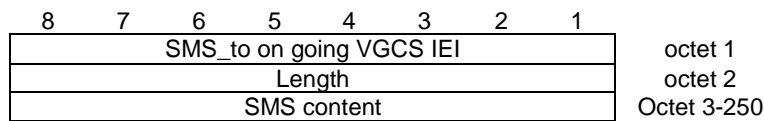

Octet 2 is a binary indication of the length of the remainder of the element in octets.

The SMS content field is coded as follows

- this field contains the RP-DATA message as defined in 3GPP TS 24.011.

### 3.2.2.93 VGCS talker mode

The *VGCS talker mode* information element contains the RR mode of the VGCS talker and the Group cipher key number in use on the voice group channel.

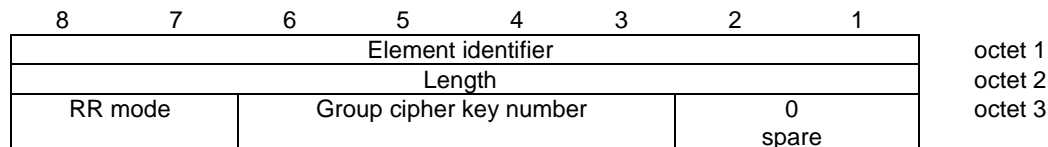

Octet 3 is coded as follows:

RR mode			
Bit			
8	7		
0	0		
dedicated mode (i.e. dedicated channel)			
0	1		
group transmit mode (i.e. voice group channel)			
Other values are reserved for future use.			
Group cipher key number			
Bit			
6	5	4	3
0	0	0	0
no ciphering			
0	0	0	1
cipher key number 1			
0	0	1	0
cipher key number 2			
0	0	1	1
cipher key number 3			
0	1	0	0
cipher key number 4			
0	1	0	1
cipher key number 5			
0	1	1	0
cipher key number 6			
0	1	1	1
cipher key number 7			
1	0	0	0
cipher key number 8			
1	0	0	1
cipher key number 9			
1	0	1	0
cipher key number A			
1	0	1	1
cipher key number B			
1	1	0	0
cipher key number C			
1	1	0	1
cipher key number D			
1	1	1	0
cipher key number E			
1	1	1	1
cipher key number F			

### 3.2.2.94 VGCS/VBS Cell Status

This BSSMAP information element is used by the BSS to indicate to the MSC the status of an individual cell for the voice group or broadcast call.

The VGCS/VBS Cell Status IE is coded as follows:

8	7	6	5	4	3	2	1	octet 1 octet 2 octet 3
Element identifier								
Length								
Spare				Status				

Octet 3 is coded as follows:

Bit 1-3 is the cell's status for the voice group or broadcast call (Status).

Bit

**3 2 1**

0 0 0	Cell is established for the voice group or broadcast call
0 0 1	Cell is not established for the voice group or broadcast call. Establishment by the BSS is to be attempted
0 1 0	Cell is released for the voice group or broadcast call because no user is present
0 1 1	Cell is not established for the voice group or broadcast call. No establishment by the BSS is to be attempted
1 0 0	Reserved
1 0 1	Reserved
1 1 0	Reserved
1 1 1	Reserved

### 3.2.2.95 GANSS Assistance Data

This is a variable length information element indicating the requested GANSS assistance data.

It is coded as follows:

8	7	6	5	4	3	2	1	octet 1 octet 2 octet 3-n
Element identifier								
Length								
GANSS Assistance Data								

The coding of octet 2 is a binary number indicating the length of the remaining element.

The GANSS Assistance Data octets 3 to n are coded as the Requested GANSS Data element of 3GPP TS 49.031.

### 3.2.2.96 GANSS Positioning Data

This element indicates the data on the positioning process for possible use in billing in location method evaluation.

It is coded as follows:

8	7	6	5	4	3	2	1	octet 1 octet 2 octet 3-n
Element identifier								
Length								
GANSS Positioning data								

The coding of octet 2 is a binary number indicating the length of the remaining element.

The GANSS Positioning Data octets 3 to n are coded as the GANSS Positioning Data element of 3GPP TS 49.031.



### 3.2.2.97 GANSS Location Type

The GANSS Location Type information element indicates the type of GANSS location request.

It is coded as follows:

8	7	6	5	4	3	2	1	
Element identifier								octet 1
Length								octet 2
GANSS Location Type								octet 3-n

The coding of octet 2 is a binary number indicating the length of the remaining element.

The GANSS Location Type octets 3 to n are coded as the GANSS Location Type element of 3GPP TS 49.031.

### 3.2.2.98 Application Data

8	7	6	5	4	3	2	1	
Element identifier								octet 1
Length								octet 2
Application Data								octet 3-11

Octets 3-11 contain the Application Data as coded in 3GPP TS 44.018, not including the 3GPP TS 44.018 element identifier.

### 3.2.2.99 Data Identity

8	7	6	5	4	3	2	1	
Element identifier								octet 1
Length								octet 2
Data Identity								octet 3

Octet 3 contains the Data Identity as coded in 3GPP TS 44.018, not including the 3GPP TS 44.018 element identifier.

### 3.2.2.100 Application Data Information

This information element is used by the BSS to provide information associated with application data which has been received from a mobile station and is being forwarded to the MSC..

The Application Data Information IE is coded as follows:

8	7	6	5	4	3	2	1	
Element identifier								octet 1
Length								octet 2
Spare							BT Ind	octet 3

Octet 3 is coded as follows:

Bit 1 is the BSS transmission indication (BT Ind) and indicates whether the BSS has already transmitted the application data to cells in the group call area with which it is associated.

Bit

**1**

0

1

BSS has not transmitted the application data to cells

BSS has already transmitted the application data to cells

3.2.2.101 MSISDN

8	7	6	5	4	3	2	1	
Element identifier								octet 1
Length								octet 2
MSISDN								octet 3-12

Octets 3-12 contain the digits of an MSISDN, coded as in 3GPP TS 24.008, Calling party BCD number, octets 4 – 13.

3.2.2.102 AoIP Transport Layer Address

This Information Element provides either an IPv4 or and IPv6 Address and UDP port value for the Transport Layer information of the connection end point. The Length differentiates between IPv4 and IPv6.

In case of an IPv4 Address it is coded as follows:

8	7	6	5	4	3	2	1	
Element identifier								octet 1
Length = 6								octet 2
IPv4 Address (MSByte first – LSByte last)								octet 3-6
UDP Port Value (MSByte first – LSByte last)								octet 7-8

In case of an IPv6 Address it is coded as follows:

8	7	6	5	4	3	2	1	
Element identifier								octet 1
Length = 18								octet 2
IPv6 Address (MSByte first – LSByte last)								octet 3-18
UDP Port Value (MSByte first – LSByte last)								octet 19-20

3.2.2.103 Speech Codec List

8	7	6	5	4	3	2	1	
Element identifier								octet 1
Length								octet 2
Speech Codec Element 1								octet 3- (3+m)
Speech Codec Element n								octet p- (p+k)

The length indicator (octet 2) is a binary number indicating the absolute length of the contents after the length indicator. The length depends on the number and type of Speech Codec Elements to be included. The minimum length of one Speech Codec Element is 1 octet and the maximum length is 3 octets. The maximum number of Speech Codec Elements within the Speech Codec List is not defined.

The coding of one "Speech Codec Element" is in general:

8	7	6	5	4	3	2	1		
FI	PI	PT	TF	Codec Type				octet z	m
Extended Codec Type								octet z+1	c
Configuration								octet z+2	c
Configuration								octet z+3	c

The "Codec Type" field specifies the Codec Type for the radio interface. It may contain a certain 3GPP Speech Codec Type directly (see below) or it may contain the so called "Codec Extension" = 0xFh, in which case the real Codec Type follows in the next octet as "Extended Codec Type". This extension mechanism is necessary in order to allow more than 16 different Codec Types in future. None, one or two "Configuration" octets may follow after the "(Extended) Codec Type" octet, depending on the specified Codec Type. Each Codec Type is in addition associated with 4 bits to specify

the A-Interface Type and the transcoder resource location (FI = "full IP", PI = "PCM over IP", PT = "PCM over TDM", TF = "TFO Flag").

In order to support also Circuit Switched Data and Fax services a so called "CSData Codec" is used, see below.

This 'Speech Codec List' Information Element is used for "Codec List (BSS Supported)" and "Codec List (MSC Preferred)".

Each Speech Codec Element in a Speech Codec List contains a Codec Type, supported on the radio interface by the BSS (in the "Codec List (BSS Supported)") or preferred (on the radio interface) by the MSC (in the "Codec List (MSC Preferred)").

The "**Codec List (BSS Supported)**" contains all the codecs for which the BSS wants to indicate support, not depending on the "Codec List (MSC Preferred)" and the MS capabilities. The "Codec List (BSS Supported)" is not in priority order and may include any number of Codec Types and any number of Codec Configurations per Codec Type and any A-Interface Type per Codec Type. The same Codec Type can be listed more than once, e.g. for AMR Codec Types, to indicate TFO/TrFO support for some combinations of AMR configurations and A-Interface Types only. The mandatory GSM\_FR may be excluded from the list (e.g. in overload conditions, when half rate Codecs are preferred).

The "**Codec List (MSC Preferred)**" contains all the codecs for which the MSC wants to indicate support, by taking into account BSS and MS capabilities as well. This is the list of codecs allowed by the MSC for this assignment or handover (see [51] for more information). The "Codec List (MSC Preferred)" may include codecs that are not included in the "Codec List (BSS Supported)". The "Codec List (MSC Preferred)" shall not include codecs that are not supported by the MS. The codecs in the "Codec List (MSC Preferred)" shall be listed in priority order as set by the MSC, with the most preferred Codec Type first (e.g. the one that may enable TrFO or TFO). The "Codec List (MSC Preferred)" may contain any number of Codec Types and any number of Codec Configurations per Codec Type and any A-Interface Type per Codec Type. If more than one A-Interface Type is indicated for one Codec Type, then FI has higher priority than PI and this has higher priority than PT, see below. The same Codec Type can be listed more than once, e.g. it can be included at the top of the list (most preferred Codec Type) with one Codec Configuration or A-interface type only, and then with all the possible configurations further down in the list. If there are no common codecs between Codec List (BSS Supported) and the codecs supported by MS, then GSM-FR shall always be included in the Codec List (MSC Preferred) as a default option.

For true Speech Codec Types (not the CSData Codec Type) these four bits have the following meaning for the A-Interface Type:

#### **FI** indicates Full IP

- "1" means: AoIP with compressed speech via RTP/UDP/IP is supported by the BSS (in the "Codec List (BSS Supported)") or preferred by the MSC (in the "Codec List (MSC Preferred)") for this Codec Type. A Transcoder Resource is not necessary in BSS.
- "0" means: Compressed speech via RTP/UDP/IP is not supported by the BSS or not preferred by the MSC for this Codec Type.

#### **PI** indicates PCMoIP

- "1" means: Transport of PCM over A-Interface via RTP/UDP/IP is supported by the BSS (i.e. a Transcoder Resource may be located in BSS) or preferred by the MSC (i.e. a Transcoder Resource needs to be located in BSS) for this (radio) Codec Type.
- "0" means: PCM over A interface with IP as transport is not supported by the BSS or not preferred by the MSC for this Codec Type

#### **PT** indicates PCMoTDM

- "1" means: Transport of PCM over A-Interface via TDM is supported by the BSS (i.e. a Transcoder Resource may be located in BSS) or preferred by the MSC (i.e. a Transcoder Resource needs to be located in BSS) for this (radio) Codec Type.
- "0" means: PCM over A-Interface with TDM as transport is not supported by the BSS or not preferred by the MSC for this Codec Type.

#### **TF** indicates TFO support

- "1" means: TFO supported by the BSS or TFO support is preferred by the MSC for this Codec Type
- "0" means: TFO is not supported by the BSS or TFO support is not preferred by the MSC for this Codec Type

The TF bit is valid only if either the PI or the PT bit are set to "1" and indicates whether the sender supports the TFO functionality for the corresponding call. TF bits in the "Codec List (MSC Preferred)" do not mandate the establishment of TFO, which may only be performed through in-band TFO procedures.

The Codec Type is valid if at least one of FI, PI or PT is set to "1". If the Codec Type is not valid the Speech Codec Element shall be ignored.

For the CSData Codec Type these four bits have the following meaning for the A-Interface Type :

**FI** is undefined and reserved for future use. It is coded with zero.

**PI** indicates CSDoIP

"1" means: Transport of Circuit Switched Data over the A-Interface via RTP/UDP/IP is supported by the BSS or preferred by the MSC. The Rate Adaptation Ressource needs to be located in BSS for this.

"0" means: Transport of Circuit Switched Data over A interface via RTP/UDP/IP is not supported by the BSS or not preferred by the MSC.

**PT** indicates CSDoTDM

"1" means: Transport of Circuit Switched Data over the A-Interface via TDM is supported by the BSS or preferred by the MSC. The Rate Adaptation Ressource needs to be located in BSS for this.

"0" means: Transport of Circuit Switched Data over A interface via TDM is not supported by the BSS or not preferred by the MSC.

**TF** is undefined and reserved for future use. It is coded with zero.

The Codec Type is valid if at least one of FI, PI or PT is set to "1". If the Codec Type is not valid the Speech Codec Element shall be ignored.

The coding of Speech Codec Element for GSM\_FR, GSM\_HR or GSM\_EFR:

8	7	6	5	4	3	2	1	octet x
FI	PI	PT	TF	Codec Type (GSM_FR or GSM_HR or GSM_EFR)				

The Codec Type:

**GSM\_FR** is coded "0000".

**GSM\_HR** is coded "0001".

**GSM\_EFR** is coded "0010".

The coding of Speech Codec Element for FR\_AMR, HR\_AMR and OHR\_AMR:

8	7	6	5	4	3	2	1	octet y
FI	PI	PT	TF	Codec Type (FR_AMR or HR_AMR or OHR_AMR)				
S7	S6	S5	S4	S3	S2	S1	S0	octet y+1
S15	S14	S13	S12	S11	S10	S9	S8	octet y+2

The Codec Type and the Codec Configuration:

**S0 – S15** indicates the supported Codec Configurations (Config-NB-Code) by the BSS or preferred Codec Configurations by the MSC, see TS 28.062, Table 7.11.3.1.3-2: Preferred Configurations for the Adaptive Multi-Rate Codec Types.

NOTE: One of these Codec Configurations, "Config-NB-Code 1" = S1, is recommended for TrFO.

If AMR-NB is supported for compressed speech on the A-Interface, then Config-NB-Code 1 shall be supported by BSS and Core Network to guarantee interoperation, see also TS 26.103 [44]. The other preferred AMR-NB Configurations

(Config-NB-Code 0, 2..15) are optional.

**FR\_AMR** is coded "0011".

**S11**, **S13** and **S15** are reserved and coded with zeroes.

**HR\_AMR** is coded "0100".

**S6 - S7** and **S11 – S15** are reserved and coded with zeroes.

**OHR\_AMR** is coded "1011".

**S11**, **S13** and **S15** are reserved and coded with zeroes.

The coding of Speech Codec Element for **FR\_AMR-WB**, **OFR\_AMR-WB** and **OHR\_AMR-WB**:

8	7	6	5	4	3	2	1	
FI	PI	PT	TF	Codec Type (FR_AMR-WB or OFR_AMR-WB or OHR_AMR-WB)				octet z
S7	S6	S5	S4	S3	S2	S1	S0	octet z+1

The Codec Type and the Codec Configuration:

**S0 – S7** indicates the supported Allowed Codec Configuration (Config-WB-Code) by the BSS or preferred Allowed Codec Configurations by the MSC, see TS 26.103, Table 5.7-1: Allowed Configurations for the Adaptive Multi-Rate – Wideband Codec Types.

If AMR-WB is supported, Config-WB-Code 0 shall be supported (as stated in TS 26.103). The others, Config-WB-Code 2 and 4 are optional.

**FR\_AMR-WB** is coded "1001".

**S0** is set to "1". **S1 - S7** are reserved and coded with zeroes.

**OFR\_AMR-WB** is coded "1100".

**S0, S2, S4** indicates the supported Codec Configurations. **S1, S3, S5, S6, S7** are reserved and coded with zeroes.

**OHR\_AMR-WB** is coded "1101".

**S0** is set to "1". **S1 - S7** are reserved and coded with zeroes.

The coding of Speech Codec Element for the **CSDData** Codec Type is:

8	7	6	5	4	3	2	1	
-	PI	PT	-	0xFh				octet y
Extended Codec Type (CSDData)								octet y+1
R2	R3	spare						octet y+2

The Codec Type and the Codec Configuration:

In order to reduce data loss caused by single or double lost RTP packets in IP transport, several redundant (i.e. repeated) data blocks may be packed into one RTP packet after this redundancy has been negotiated between BSS and MSC.

"Redundancy Level" is a bitmap indicating the values of the redundancy level related to the RTP packet. "Redundancy Level" could be considered as the Configuration of CSDData Codec Type. This octet is always included (even if PI = 0), although Redundancy Level is not defined for the legacy A-Interface (PT = 1).

**R2** and **R3** indicate the support of the Redundancy Level 2 (optional) and 3 (optional), while support of Redundancy Level 1 (one data block is contained in one RTP packet, i.e., no redundancy is used) is mandatory. The redundancy levels are not depending on each other, it is for example allowed to support redundancy level 1 and 3 without supporting redundancy level 2.

**R2** indicates Redundancy Level = 2 (two successive data blocks are contained in one RTP packet):

"1" means: Redundancy Level = 2 is supported;  
 "0" means: Redundancy Level = 2 is not supported.

**R3** indicates Redundancy Level = 3 (three successive data blocks are contained in one RTP packet):

"1" means: Redundancy Level = 3 is supported;  
 "0" means: Redundancy Level = 3 is not supported.

In Codec List (BSS Supported) and Codec List (MSC Preferred) more than one of these A-Interface Types and Redundancy Levels may be flagged to allow an open negotiation and to restrict the negotiation as far as necessary. But in "Speech Codec (Used)", "Speech Codec (Chosen)" and "Speech Codec (MSC Chosen)" exactly one A-Interface Type and exactly one Redundancy Level shall be specified. Redundancy Level 1 is specified by flagging neither R2 nor R3.

The existing "Channel Type" IE contains all the other parameters for fax and data calls. This Channel Type IE and the CSData Codec Type shall contain consistent data.

Spare bits are reserved and coded with zeroes.

**CSData** is coded with 0xFDh or "1111 1101" (see also TS 26.103).

### 3.2.2.104 Speech Codec

8	7	6	5	4	3	2	1	
Element identifier								octet 1
Length								octet 2
Speech Codec Element 1								octet 3- (3+m)
Speech Codec Element n								octet p- (p+k)

The length indicator (octet 2) is a binary number indicating the absolute length of the contents after the length indicator. The length depends on the number and type of Speech Codec Elements to be included. The minimum length of one Speech Codec Element is 1 octet and the maximum length is 3 octets.

This Information Element is used for "Speech Codec (Used)", "Speech Codec (Chosen)" and "Speech Codec (MSC Chosen)". In all three cases exactly one Codec Type, exactly one Codec Configuration and exactly one A-Interface Type (and whether compressed speech via RTP/UDP/IP is used or not in case of IP user plane transport) shall be indicated, i.e. only one of the bits FI, PI or PT shall be set to 1 (see below). As an exception, in "Speech Codec (MSC Chosen)", in case of AMR-NB, there can be both, FR\_AMR, HR\_AMR and OHR Codec Types included and in case of AMR-WB, there can be both, FR\_AMR-WB, OHR\_AMR-WB and OFR\_AMR-WB Codec Types included, with the same or compatible Codec Configurations.

The Codec Type and the Codec Configuration are coded as specified in clause 3.2.2.103.

The A-Interface Type is coded as follows:

**FI** indicates Full IP

"1" means: AoIP with compressed speech via RTP/UDP/IP is selected for this Codec Type.  
 "0" means: Compressed speech via RTP/UDP/IP is not selected for this Codec Type.

This bit is not defined for the CSData Codec Type.

**PI** indicates PCMoIP

"1" means: PCM over A-Interface via RTP/UPD/IP is selected for this Codec Type.  
 "0" means: PCM over A interface with RTP/UDP/IP is not selected for this Codec Type.

**PT** indicates PCMoTDM

"1" means: PCM over A-Interface with TDM as transport is selected for this Codec Type.  
 "0" means: PCM over A-Interface with TDM as transport is not selected for this Codec Type.

**TF** indicates TFO Support

"1" means: TFO Support is selected for this Codec Type.

"0" means: TFO Support is not selected for this Codec Type.

This bit is not defined for the CSData Codec Type.

The TF bit is valid only if either the PI or the PT bit are set to "1" and indicates whether the sender supports the TFO functionality for the corresponding call. The establishment of TFO is not mandated and may only be performed through in-band TFO procedures.

The Codec Type is valid if at least one of FI, PI or PT is set to "1". If the Codec Type is not valid the Speech Codec Element shall be ignored.

### 3.2.2.105 Call Identifier

The Call Identifier information element is a value defined on a per MSC basis by which a call in the MSC and the BSS could be identified. The Call Identifier shall not be changed as long as an IP interface is used and the call is served by the same MSC and the same SCCP connection. The Call Identifier information element is included if the core network supports an IP based User Plane interface.

The Call Identifier is a logical concept. It is used to identify an IP based call in control plane.

Call Identifier shall only be allocated by MSC.

The element is 4 octets in length:

8	7	6	5	4	3	2	1	
Element identifier								octet 1
Call Identifier (least significant bits)								octet 2
Call Identifier								octet 3
Call identifier								octet 4
Call Identifier (most significant bits)								octet 5

### 3.2.2.106 Call Identifier List

This IE identifies a list of Call Identifiers.

It is coded as follows:

8	7	6	5	4	3	2	1	
Element identifier								Octet 1
Length								Octet 2
Call Identifier 1								Octet 3-6
...								
Call Identifier n								n*4-1 - n*4+2

The coding of octet 2 is a binary number indicating the length of the remaining element.

The Call Identifier List may include from one up to 62 Call Identifiers.

NOTE: The upper limit of 62 Call Identifiers keeps the RESET IP RESOURCE message below 255 octets.

### 3.2.2.107 A-Interface Selector for RESET

This optional IE may identify the calls that shall be cleared.

It is coded as follows:

8	7	6	5	4	3	2	1	
Element identifier								Octet 1
spare						RIP	RTD	Octet 2

**RIP** indicates "Reset all calls associated to IP links":

'1' means: all calls associated to IP links shall be cleared;  
 '0' means: calls associated to IP links shall not be cleared.

**RTD** indicates "Reset all calls associated to TDM circuits":

'1' means: all calls associated to TDM links shall be cleared;  
 '0' means: calls associated to TDM links shall not be cleared.

### 3.2.2.108 (void)

### 3.2.2.109 $Kc_{128}$

This element contains the 128 bit long encryption key used in connection with the encryption algorithm A5/4.

It is a fixed length element.

It is coded as follows:

8	7	6	5	4	3	2	1
Element identifier							
$Kc_{128}$							

octet 1  
octet 2-17

### 3.2.2.110 CSG Identifier

This element indicates the identifier of the Closed Subscriber Group within the PLMN, as defined in [2] and the cell access mode of the cell as defined in [32],[50]. It contains the following fields:

8	7	6	5	4	3	2	1
Element identifier							
Length							
CSG Id							
Spare							Cell Acce ss Mode

octet 1  
octet 2  
octet 3-6  
octet 7

Octets 3 to 6 contain the *CSG Identity (CSG-ID)* of the cell (defined in 3GPP TS 23.003) as reported by the mobile station (see 3GPP TS 44.018). Bits 4 to 8 of octet 6 are spare and set to zero.

The Cell Access Mode (bit 1 of octet 7) field indicates whether a cell is a Closed access mode, i.e a CSG cell, or in a Hybrid access mode, i.e. a hybrid cell (see 3GPP TS22.220, 3GPP TS 44.018). It is coded as follows:

Bit

1

0 CSG cell

1 Hybrid cell

Spare bits are reserved and coded with zeroes.

### 3.2.2.111 Redirect Attempt Flag

This IE indicates that the CN should respond with a REROUTE COMMAND or a REROUTE COMPLETE message.

It is coded as follows:

8	7	6	5	4	3	2	1
Element identifier							

octet 1



### 3.2.2.112 Reroute Reject Cause

This IE indicates the cause of the reject of the Initial MS message in case of MOCN configuration for network sharing.

It is coded as follows:

8	7	6	5	4	3	2	1
Element identifier							
Reroute Reject cause value							

octet 1  
octet 2

Reroute Reject cause value (octet 2)							
Bits							
8	7	6	5	4	3	2	1
0	0	0	0	0	0	0	0
Reserved							
0	0	0	0	1	0	1	0
Reserved							
0	0	0	0	1	0	1	1
PLMN not allowed (meaning is defined in [6])							
0	0	0	0	1	1	0	0
location area not allowed (meaning is defined in [6])							
0	0	0	0	1	1	0	1
roaming not allowed in this location area (meaning is defined in [6])							
0	0	0	0	1	1	1	0
GPRS services not allowed in this PLMN (meaning is defined in [6])							
0	0	0	0	1	1	1	1
no suitable cell in location area (meaning is defined in [6])							
0	0	0	1	0	0	0	0
CS/PS domain registration coordination required (meaning defined in [51])							
0	0	0	1	0	0	0	1
Reserved							
1	1	1	1	1	1	1	1
Reserved							

### 3.2.2.113 Send Sequence Number

This IE indicates the value of the Send Sequence Number as defined in [6].

It is coded as follows:

8	7	6	5	4	3	2	1
Element identifier							
Send Sequence Number		spare					

octet 1  
octet 2

Octet 2 is coded as in message type IE defined in [6].

### 3.2.2.114 Reroute complete outcome

This IE indicates the outcome of the reroute procedure in case of MOCN configuration for network sharing.

It is coded as follows:

8	7	6	5	4	3	2	1
Element identifier							
Outcome value							

octet 1  
octet 2

Outcome value (octet 2)								
Bits								
8	7	6	5	4	3	2	1	
0	0	0	0	0	0	0	0	Reserved
0	0	0	0	0	0	0	1	MS is accepted
0	0	0	0	0	0	1	0	MS is not accepted
0	0	0	0	0	0	1	1	MS is already registered
0	0	0	0	0	1	0	0	Reserved
1	1	1	1	1	1	1	1	Reserved

### 3.2.2.115 Global Call Reference

The Global Call Reference IE contains a globally unique call identifier valid for the duration of the call, consisting of a Network ID, a Node ID and a Call Reference ID.

This is a variable length information element coded as follows:

8	7	6	5	4	3	2	1	
Element identifier								octet 1
Length								octet 2
Global Call Reference Identifier								octet 3-n

The length indicator (octet 2) is a binary number indicating the absolute length of the contents after the length indicator octet.

The Global Call Reference Identifier field is coded as the LCLS Global Call Reference Identifier as specified in 3GPP TS 29.205.

### 3.2.2.116 LCLS-Configuration

This information element indicates the LCLS connection preference that shall persist in the BSS while local switching is established.

The information element has a fixed length of two octets and is coded as follows:

8	7	6	5	4	3	2	1	
Element identifier								octet 1
Spare				LCLS-Configuration				octet 2

Bits 1 to 4 of octet 2 contain the LCLS-Configuration field indicating the requested LCLS connection preference on a call leg basis.

The LCLS-Configuration field is coded as follows:

Bit	
<b>4 3 2 1</b>	
0 0 0 0	Connect both-way
0 0 0 1	Connect both-way and bi-cast UL to the core network
0 0 1 0	Connect both-way and send access DL from the core network
0 0 1 1	Connect both-way and send access DL from the core network, block local DL user data
0 1 0 0	Connect both-way and bi-cast UL to the core network with send access DL from the core network
0 1 0 1	Connect both-way and bi-cast UL to the core network with send access DL from the core network, block local DL user data

All other values are reserved for future use.

For details of the different LCLS configuration values, see sub-clause 3.1.33.2.2.

If the requested LCLS configuration is not supported in BSS this shall be indicated via the LCLS-BSS-Status IE, see sub-clause 3.2.2.119.

### 3.2.2.117 LCLS-Connection-Status-Control

This information element indicates the requested LCLS connection status for a call leg associated to a local call in the BSS to, e.g. establish local switching, do not establish local switching or release an already established locally switched call.

The information element has a fixed length of two octets and is coded as follows:

8	7	6	5	4	3	2	1	
Element identifier								octet 1
Spare				LCLS-Connection-Status-Control				octet 2

Bits 1 to 4 of octet 2 contain the LCLS-Connection-Status-Control field indicating the requested LCLS connection status on a call leg basis.

The LCLS-Connection-Status-Control field is coded as follows:

Bit	
<b>4 3 2 1</b>	
0 0 0 0	Connect
0 0 0 1	Do not connect
0 0 1 0	Release LCLS
0 0 1 1	Bi-cast at Handover

All other values are reserved for future use.

### 3.2.2.118 LCLS-Correlation-Not-Needed

This information element indicates that call leg correlation is not needed in the BSS.

The information element has a fixed length of one octet and is coded as follows:

8	7	6	5	4	3	2	1	
Element identifier								octet 1

### 3.2.2.119 LCLS-BSS-Status

This information element indicates the LCLS connection status for a call leg in the BSS.

The information element has a fixed length of two octets and is coded as follows:

8	7	6	5	4	3	2	1	
Element identifier								octet 1
Spare				LCLS-BSS-Status				octet 2

Bits 1 to 4 of octet 2 contain the LCLS-BSS-Status field indicating the LCLS connection status on a call leg basis.

The LCLS-BSS-Status field is coded as follows:

Bit	
<b>4 3 2 1</b>	
0 0 0 0	Call not yet locally switched
0 0 0 1	Call not possible to be locally switched
0 0 1 0	Call is no longer locally switched
0 0 1 1	Requested LCLS configuration is not supported
0 1 0 0	Call is locally switched with requested LCLS configuration

All other values are reserved for future use.

### 3.2.2.120 LCLS-Break-Request

This information element indicates a request to break the locally switched call.

The information element has a fixed length of one octet and is coded as follows:

8	7	6	5	4	3	2	1
Element identifier							

octet 1

### 3.2.2.121 CSFB Indication

This information element indicates that the connection was established as a result of a CSFB procedure.

The information element has a fixed length of one octet and is coded as follows:

8	7	6	5	4	3	2	1
Element identifier							

octet 1

## 3.2.3 Signalling Field Element Coding

The coding rules for signalling field elements are the same as the signalling element coding rules which are defined in sub-clause 3.2.2.

Signalling field elements shall always include a Field Length indicator. A Field Length indicator with a value of zero shall not be considered as an error.

Field Element Identifier Coding	Field Element name	Reference
0000 0001	Extra information	3.2.3.1
0000 0010	Current Channel Type 2	3.2.3.2
0000 0011	Target cell radio information	3.2.3.3
0000 0100	GPRS Suspend information	3.2.3.4
0000 0101	MultiRate configuration information	3.2.3.5
0000 0110	Dual Transfer Mode information	3.2.3.6
0000 0111	Inter RAT Handover Info	3.2.3.7
0000 1000	cdma2000 Capability Information	3.2.3.8
0000 1001	Downlink Cell Load Information	3.2.3.9
0000 1010	Uplink Cell Load Information	3.2.3.10
0000 1011	Cell Load Information Group	3.2.3.11
0000 1100	Cell Load Information	3.2.3.12
0000 1101	PS Indication	3.2.3.13
0000 1110	DTM Handover Command Indication	3.2.3.14
1111 1110	D-RNTI	3.2.3.15
0000 1111	IRAT Measurement Configuration	3.2.3.16

All other values are for future use.

### 3.2.3.1 Extra information

This field element provides a general flag mechanism that allows the old BSS to indicate to the new BSS flag information.

It is coded as follows:

8	7	6	5	4	3	2	1
Field Element identifier							
Length							

octet 1  
octet 2  
octet 3

Octet 2 is a binary indication of the length of the rest of the field element.

Octet 3 is coded as follows:

8	7	6	5	4	3	2	1	octet 3
spare					UE-prob	lcs	prec	

Bit 8 to 4 are flags that indicate no information.

prec = Pre-emption Recommendation:

- 0 The old BSS recommends that this allocation request should not cause a pre-emption an existing connection;
- 1 The old BSS recommends that this allocation request is allowed to preempt an existing connection based on the information supplied in the Priority information element, if available.

In the case the "prec" bit is not present or the Extra Information field element is not present then the new BSS should run pre-emption as specified by the Priority information element, if available.

In the case where the Priority information element is not present in the request then the "prec" element, if present, shall be ignored.

lcs = Location Services (LCS) information:

- 0 No ongoing LCS procedure;
- 1 An ongoing LCS procedure was interrupted by handover. The new BSS may notify the SMLC when the handover is completed.

UE-prob = support of handover to UMTS for this MS:

- 0 This MS supports handover to UMTS;
- 1 This MS does not support handover to UMTS.

### 3.2.3.2 Current Channel type 2

This Field Element contains a description of the channel allocated to the MS.

It is coded as follows:

8	7	6	5	4	3	2	1	octet 1 octet 2 octet 3 octet 4
Field Element identifier								
Length								
Channel mode								
Channel field								

The channel mode field is coded as follows:

Bit	
<b>4321</b>	
0000	signalling only
0001	speech (full rate or half rate)
0110	data, 14.5 kbit/s radio interface rate
0011	data, 12.0 kbit/s radio interface rate
0100	data, 6.0 kbit/s radio interface rate
0101	data, 3.6 kbit/s radio interface rate
1111	is reserved

All other values indicate that no information is provided.

Bits 8 to 5 are spare.

The channel field is coded as follows:

**Bit:**

**4321**

0001	SDCCH
1000	1 Full rate TCH
1001	1 Half rate TCH
1010	2 Full Rate TCHs
1011	3 Full Rate TCHs
1100	4 Full Rate TCHs
1101	5 Full Rate TCHs
1110	6 Full Rate TCHs
1111	7 Full Rate TCHs
0100	8 Full Rate TCHs
0000	is reserved

All other values indicate that no information is provided.

Bits 8 to 5 are spare.

### 3.2.3.3 Target cell radio information

It is coded as follows:

8	7	6	5	4	3	2	1
Field Element identifier							
Length							

octet 1  
octet 2  
octet 3

Octet 2 is a binary indication of the length of the rest of the element.

Octet 3 is coded as follows:

8	7	6	5	4	3	2	1
RXLEV-NCELL							

octet 3

Bit 8 to 7 is spare, set to 0

Bit 6 to 1 is the RXLEV-NCELL field.

The RXLEV-NCELL field is coded as the binary representation of a value N. N corresponds according to the mapping defined in TS. 3GPP TS 45.008 to the received signal strength on the target cell.

### 3.2.3.4 GPRS Suspend Information

This Field Element contains the contents of the Gb interface SUSPEND ACK PDU.

It is coded as follows:

8	7	6	5	4	3	2	1
Field Element identifier							
Length							
Gb interface TLLI IEI							
Length of TLLI							
TLLI							
Gb interface RAI IEI							
Length of RAI							
RAI							
Gb interface SRN IEI							
Length of SRN							
Suspend reference number							

octet 1  
octet 2  
octet 3  
octet 4  
octet 5-5+m  
octet 6+m  
octet 7+m  
octet 7+m-n  
octet n+1  
octet n+2  
octet n+3-p

The coding of the fields are not relevant to 3GPP TS 24.008.

### 3.2.3.5 MultiRate configuration Information

This Field Element contains a description of the multi-rate speech codec configuration currently used.

It is coded as follows:

8	7	6	5	4	3	2	1	
Field Element identifier								octet 1
Length								octet 2
Rest of element coded as in 3GPP TS 44.018, not including 3GPP TS 44.018 element identifier or 3GPP TS 44.018 octet length value								octet 3-n

### 3.2.3.6 Dual Transfer Mode information

This Field Element contains information about a mobile in dual transfer mode. This information may be used for the target BSS to allocate the resources for the RR connection (e.g. TCH/H, TCH in an EGPRS transceiver).

It is coded as follows:

8	7	6	5	4	3	2	1	
Field Element identifier								octet 1
Length								octet 2
Spare					EGPRS ind	STO ind	DTM ind	octet 3

Octet Bit 1 is the dual transfer mode indicator. It indicates whether the MS is in dedicated mode or in dual transfer mode. This bit shall also be used in the case of handover to GERAN from another RAT to indicate the allocation of resources for the CS and PS domain in the old cell. It is coded as follows:

Bit

**1**

0

The MS has resources allocated exclusively for the CS domain in the old cell

1

The MS has resources allocated for both the CS and PS domains in the old cell

Bit 2 is the single timeslot operation indicator. It indicates whether the MS has a TCH/H and a PDCH/H; see 3GPP TS 45.002. It is coded as follows:

Bit

**2**

0

The MS is in multislot operation in the old cell

1

The MS is in single timeslot operation in the old cell

Bit 3 is the EGPRS indicator. It is coded as follows:

Bit

**3**

0

The MS has no TBF using E-GPRS in the old cell

1

The MS has a TBF using E-GPRS in the old cell

Bits 8 to 4 of octet 3 are spare.

### 3.2.3.7 Inter RAT Handover Info

The Inter RAT Handover Info information element is coded as follows:

8	7	6	5	4	3	2	1	
Field Element identifier								octet 1
Length								octet 2
Inter RAT Handover Info								octet 3-n

Octets 3-n are encoded as Inter RAT Handover Info as defined in 3GPP TS 25.331.

### 3.2.3.8 cdma2000 Capability Information

The cdma2000 Capability Information element is coded as follows:

8	7	6	5	4	3	2	1	
Field Element identifier								octet 1
Length								octet 2
cdma2000 capability information								octet 3-n

Octets 3-n are encoded as octets 3-n of the cdma2000 Classmark Change message defined in 3GPP TS 44.018.

### 3.2.3.9 Downlink Cell Load Information

This field element contains information about the downlink traffic load of a cell during a handover procedure. It refers either to the source or target cell depending on the direction of the message containing the Information Element where this field element is present. It is coded as follows:

8	7	6	5	4	3	2	1	
Field Element identifier								octet 1
Length								octet 2
Cell Load Information								octet 3-n

The container structure and encoding of the *Cell Load Information* is defined in sub-clause 3.2.3.12.

### 3.2.3.10 Uplink Cell Load Information

This field element contains information about the uplink traffic load of a cell during a handover procedure. It refers either to the source or target cell depending on the direction of the message containing the Information Element where this field element is present. It is coded as follows:

8	7	6	5	4	3	2	1	
Field Element identifier								octet 1
Length								octet 2
Cell Load Information								octet 3-n

The container structure and encoding of the *Cell Load Information* is defined in sub-clause 3.2.3.12.

### 3.2.3.11 Cell Load Information Group

This field element contains the load information of the source cell for either the Downlink or the Uplink or both as well as the source cell identifier the included cell load information corresponds to during a handover procedure. It is coded as follows:

8	7	6	5	4	3	2	1	
Field Element identifier								octet 1
Length								octet 2
Cell Identifier								octet 3-n
Cell Load Information Group elements								octet (n+1)- (n+m)



The *Cell Identifier* identifies the source cell. The structure and encoding of *Cell Identifier* is described in sub-clause 3.2.2.17. For a GERAN source cell, Cell identification discriminator = 0000. For a UTRAN source cell, Cell identification discriminator = 1100.

The *Cell Load Information Group elements* field is made up of zero or more of the field elements listed below.

FIELD ELEMENT	REFERENCE	LEN
Downlink Cell Load Information	3.2.3.9	8
Uplink Cell Load Information	3.2.3.10	8

### 3.2.3.12 Cell Load Information

This field element contains the load information of a specific (serving or target) cell for either the Downlink or the Uplink. It is coded as follows:

8	7	6	5	4	3	2	1	
Field Element identifier								octet 1
Length								octet 2
Cell Capacity Class Value								octet 3
Load Value								octet 4
RT Load Value								octet 5
NRT Load Information Value								octet 6

*Cell Capacity Class Value* is the value that classifies the cell capacity with regards to the other cells. It only indicates resources that are configured for traffic purposes. *Cell Capacity Class Value* may take binary coded integer values from and including 1 up to and including 100. Other values shall be considered as an error. Value 1 shall indicate the minimum cell capacity, and 100 shall indicate the maximum cell capacity. There should be linear relation between cell capacity and *Cell Capacity Class Value*.

*Load Value* contains the total cell load relative to the maximum planned load. It is defined as the load percentage of the Cell Capacity Class. *Load Value* may take binary coded integer values from and including 0 up to and including 100. Other values shall be considered as an error. Value 0 shall indicate the minimum load, and 100 shall indicate the maximum load. *Load Value* should be measured on a linear scale.

*RT Load Value* indicates in percents the ratio of the load generated by Real Time traffic relative to the measured Load Value. Real Time traffic corresponds to the Conversational and Streaming traffic classes. *RT Load Value* may take binary coded integer values from and including 0 up to and including 100. Other values shall be considered as no information.

*NRT Load Information Value* indicates the load situation on the cell for Non Real-Time traffic. Non Real-Time traffic corresponds to the Interactive and Background traffic classes. *NRT Load Information Value* may take binary coded integer values from and including 0 up to and including 3. Other values shall be considered as no information. The values shall be interpreted as:

- Value 0: NRT load is low.
- Value 1: NRT load is medium.
- Value 2: NRT load is high. (Probability to admit a new user is low.)
- Value 3: NRT overload. (Probability to admit a new user is low, packets are discarded and the source is recommended to reduce the data flow.)

### 3.2.3.13 PS Indication

This field element indicates that a handover is part of a DTM Handover procedure.

8	7	6	5	4	3	2	1	
Field Element identifier								octet 1
Length								octet 2
PS Indication Contents								octet 3

*PS Indication Contents* identifies a particular handover attempt for this MS. This shall be identical to the *CS Indication Contents* value in the corresponding *Source BSS to Target BSS Transparent Container* IE (see 3GPP TS 48.018). The

choice of the contents of this field is implementation specific, with the requirement that consecutive handover attempts for the same mobile station shall not have the same *PS Indication Contents* value.

### 3.2.3.14 DTM Handover Command Indication

The presence of this field element in the *New BSS to Old BSS Information IE* indicates that an (RLC/MAC) DTM HANDOVER COMMAND message is included within the *Layer 3 Information IE* carried within the same BSSMAP message.

8	7	6	5	4	3	2	1	
Field Element identifier								octet 1
Length								octet 2
Spare								octet 3

### 3.2.3.15 D-RNTI

This field element contains the Drift-Radio Network Temporary Identity used for identifying the MS during a handover via the Iur-g interface (see 3GPP TS 43.130). It is coded as follows:

8	7	6	5	4	3	2	1	
Field Element identifier								octet 1
Length								octet 2
Spare				D-RNTI (high part)				octet 3
D-RNTI (middle part)								octet 4
D-RNTI (low part)								octet 5

### 3.2.3.16 IRAT Measurement Configuration

The *IRAT Measurement Configuration IE* is used to indicate to the BSS which frequency measurement results of the source RAT shall be collected after a successful inter-system handover. The *IRAT Measurement Configuration IE* is used by the source RAT to specify the E-UTRA frequencies to be reported back to the source RAT (each of them associated with a measurement bandwidth), the minimum radio quality and the period of time that the measurements should last before triggering a *HO Report* for unnecessary handover to another RAT.

NOTE 1: *HO Report* is defined in 3GPP TS 36.413 [57].

NOTE 2: The functionality of Unnecessary IRAT HO is described in 3GPP TS 36.300 [59].

It is coded as follows:

8	7	6	5	4	3	2	1	
Field Element identifier								octet 1
Length								octet 2
Spare	REP_QUANT	REPORTING_THRESHOLD						octet 3
Measurement_Duration								octet 4
E-ARFCN								octets 5-6
Spare				Measurement Bandwidth				octet 7
E-ARFCN								octets 8-9
Spare				Measurement Bandwidth				octet 10
E-ARFCN								octets m-(m+1)
Spare				Measurement Bandwidth				octet m+2

**REPORTING\_THRESHOLD:** defines the reporting threshold to be used for measurement results analysis according to REP\_QUANT. This threshold is used to compare against the measurement results received from the MS. It is a value between 0 and 63 encoded on 6 bits according to 3GPP TS 45.008 [58] sub-section 8.1.5.4.

**REP\_QUANT:** indicates the measurement quantity for E-UTRAN cells coded as follows: 0=RSRP 1=RSRQ.

**Measurement\_Duration:** defines (in seconds) how long the BSS shall collect the measurements results received from the MS after a successful inter-RAT handover. It is a number in binary representation ranging from 1 to 100

**E-ARFCN:** designates a specific E-UTRA frequency for which the target RAT should continue to collect the measurement results received from MS of this frequency. It is coded as a number in binary representation ranging from 0 to 65535.

**Measurement Bandwidth:** defines the measurement bandwidth of the E-UTRA frequency signalled in the two previous octets. It is coded on 3 bits according to 3GPP TS 44.018 [32].

### 3.2.4 List of Timers in the BSSMAP Procedures

Timer	Title	Time
T1	Time to receipt of BLOCKING ACKNOWLEDGE at the BSS	O&M
T2	Reset guard period at the MSC	O&M
T4	Time to receipt of RESET ACKNOWLEDGE at the BSS	O&M
T5	Overload timer in the MSC, see sub-clause 3.1.12.1	O&M
T6	Overload timer in the MSC, see sub-clause 3.1.12.1	O&M
T7	Handover required periodicity	O&M
T8	Time to receipt of successful handover information	O&M
T10	Time to return of ASSIGNMENT COMPLETE; or ASSIGNMENT FAILURE from MS (note)	O&M
T11	Maximum allowed queuing time for assignment	O&M
T12	Time to receipt of RESET CIRCUIT ACKNOWLEDGE at the MSC	O&M
T14	Maximum allowed queuing time for VGCS/VBS assignment	O&M
T13	Reset guard period at the BSS	O&M
T16	Time to receipt of RESET ACKNOWLEDGE at the MSC	O&M
T17	Overload timer in the BSS, see sub-clause 3.1.12.1	O&M
T18	Overload timer in the BSS, see sub-clause 3.1.12.1	O&M
T19	Time to receipt of RESET CIRCUIT ACKNOWLEDGE at the BSS	O&M
T20	Time to receipt of CIRCUIT GROUP BLOCKING ACKNOWLEDGE at the BSS	O&M
T21	Time to receipt of BLOCKING ACKNOWLEDGE at the MSC	O&M
T22	Time to receipt of CIRCUIT GROUP BLOCKING ACKNOWLEDGE at the MSC	O&M
T23	Time to receipt at the old BSS of either i) a HANOVER COMMAND (containing a (RR) HANOVER COMMAND message) or ii) both a HANOVER COMMAND or HANOVER REQUIRED REJECT from the MSC and a PS HANOVER REQUIRED ACK or PS HANOVER REQUIRED NACK from the SGSN	O&M
T24	Time to receipt of both the HANOVER REQUEST and PS HANOVER REQUEST messages at the new BSS for DTM Handover	O&M (Note 2)
T25	Internal Handover Required guard time	O&M
Tqho	Maximum allowed queuing time for handover	O&M
Tast	Time to send assignment status of VGCS/ VBS resources to the MSC	O&M
Trmsc	Time to receipt of RESET IP RESOURCE ACKNOWLEDGE at the MSC	O&M
Trbss	Time to receipt of RESET IP RESOURCE ACKNOWLEDGE at the BSS	O&M
NOTE 1: T10 is not the same as T3107 as defined in 3GPP TS 24.008.		
NOTE 2: T23 shall be longer than T24		

## 3.3 SDL Representation Of The Procedures At The BSS

The SDL diagrams may be inserted at a later stage after updating and carefully checking of consistency with the main text.

## 4 Broadcast Information Control Channel

Information that is transferred in the Broadcast Control Channel is stored locally at the BSS. The scheduling of this information on the BCCH is controlled autonomously by the BSS.

The set of information that is transmitted in the BCCH is derived locally or downloaded to the BSS via the BSS Operation and Maintenance Application Part.

## 5 Definitions

For the purposes of the present document, the following terms and definitions apply:

**Base Station System (BSS):** equipment which is accessed through the interface defined in the 3GPP TS 08-series. It contains the functionality described in 3GPP TS 48.002, and supports one or more cells. See 3GPP TS 41.004.

**Base Station System Application Part (BSSAP):** subsystem that contains the process dealing with radio resource control and management known as the Base Station System Management Application Part (BSSMAP) and transparent

transfer of call control and mobility management information known as the Direct Transfer Application Part (DTAP). The BSSAPs at the BSS and the MSC are connected by means of SCCP connections.

**Base Station System Management Application Part (BSSMAP):** process within the BSS that controls radio resources in response to instructions from the MSC.

**cell load based handover:** takes place in order to avoid congestion in the old cell by handing traffic off to another cell, typically less loaded. A cell load based handover is initiated with the handover cause set to "reduce load in serving cell".

**directed retry:** process of assigning a Mobile Station to a TCH in a cell other than the serving cell, e.g. in situations of congestion. It is triggered by the assignment procedure and employs internal or external handover procedures.

**Direct Transfer Application Part (DTAP):** process which allows the direct transfer of messages between individual MSs and the MSC with no interpretation of layer 3 information at the BSS.

**IP based user plane interface is supported:** The related nodes support and can set up connections over an IP based user plane if appropriate. That is, PCM over IP or compressed speech over IP is supported over the user plane.

**internal handover:** takes place between channels on a cell or cells controlled by a single BSS. This handover operates without reference to the MSC (although the MSC will be informed on completion). Handovers of this type in one cell are called internal intra cell handovers and between cells are called internal inter cell handovers.

Handovers between channels on the same cell or between cells on the same BSS which are controlled by the MSC are external handovers and use identical procedures to those for inter-BSS handovers.

**intersystem handover:** takes place between different radio access systems (e.g. GSM BSS and UTRAN or GSM BSS and cdma2000 RAN).

**Terrestrial resource:** Resource related to a TDM or an IP based connection for the user plane.

**VGCS/VBS call controlling SCCP connection:** is an SCCP connection which supports the signalling for call SETUP of a VGCS/VBS call and the signalling for uplink control of a VGCS call. One of these connections is needed to support each instance of a VGCS/VBS call within a BSS.

**VGCS/VBS resource controlling SCCP connection:** is an SCCP connection which supports the allocation of resources for a VGCS/VBS call. One or more of these connections is needed to support each instance of a VGCS/VBS call. The exact number of these SCCP connections is equal to the number of cells to which the VGCS/VBS call is to be supported or in case of A-interface sharing equal to the number of BSCs involved in the VGCS/VBS call.

## 6 List of diagrams

Figure	Title
1	Signalling protocol reference model
2	Assignment
3	Handover execution
4	Handover required indication
5	Handover resource allocation
6	Release
7	Release due to reason at the BSS
8 (not used)	
9	Classmark updating
10	Blocking of terrestrial circuits
11	Reset
12	Resource indication
13	Handover candidate enquiry
14	Flow control
15	Paging
16	Overview of handover procedure between two BSS's on the same MSC
17	Cipher mode control
18	SAPI "n" rejection
19	Load indication
20	SUCCESSFUL UPLINK ALLOCATION
21	UNSUCCESSFUL UPLINK ALLOCATION
22	UPLINK RELEASE INDICATION
23	UPLINK SEIZE COMMAND
24	UPLINK RELEASE COMMAND
25	Blocking of terrestrial circuits, MSC initiated
26	Circuit re-selection
27	Internal Handover procedure
28	Rerouting

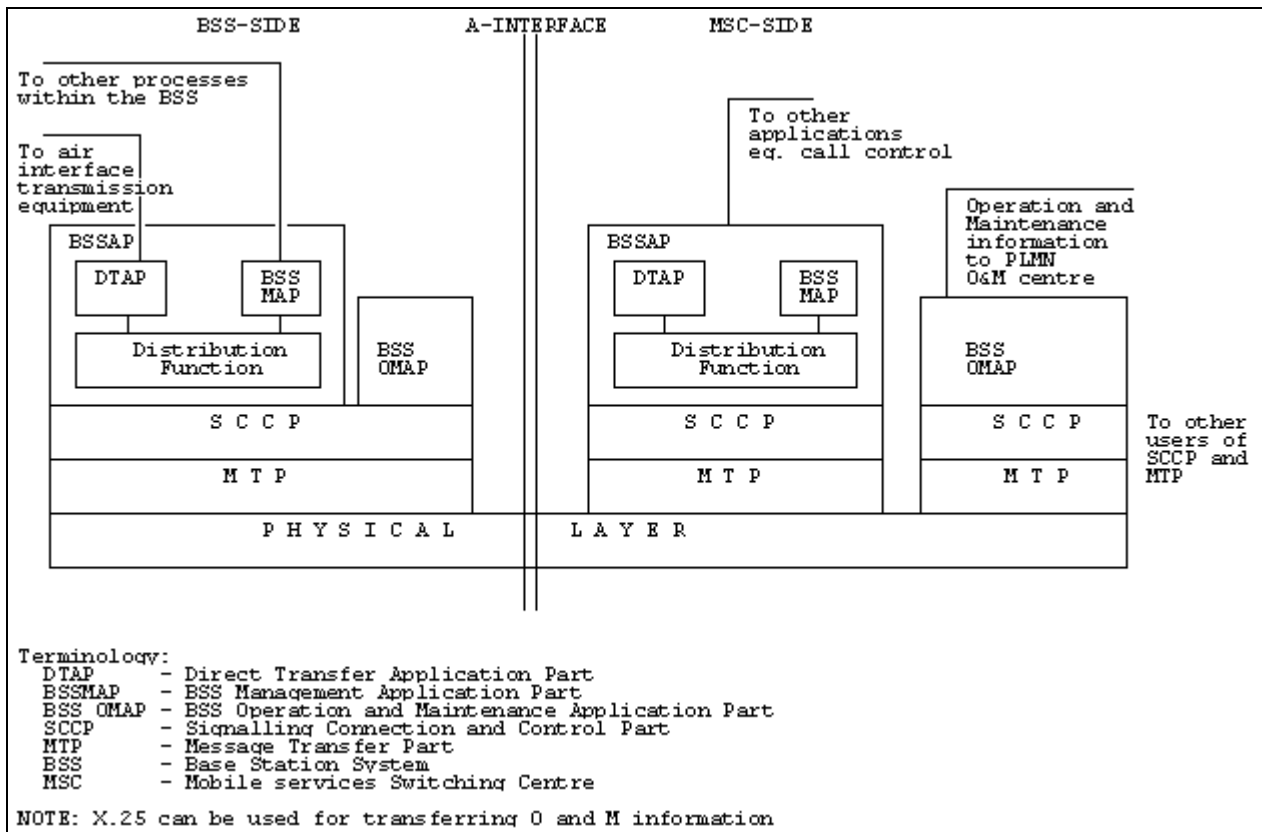

Figure 1: SIGNALLING PROTOCOL REFERENCE MODEL

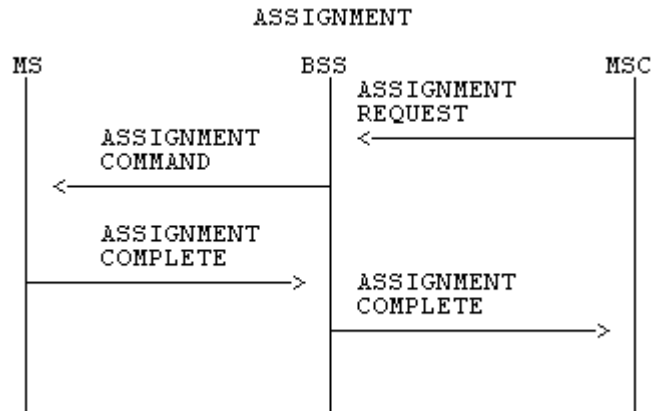
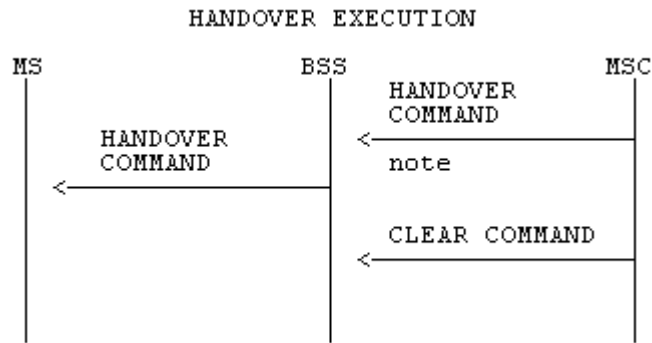
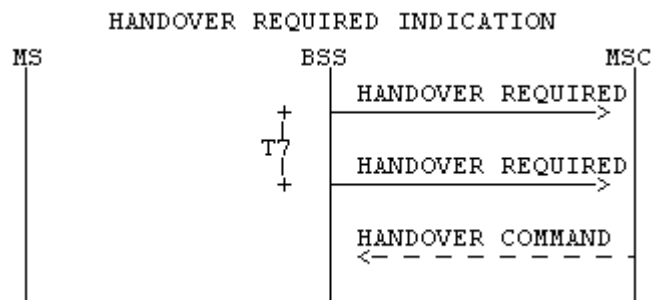

Figure 2



NOTE: A timer T8 is started to protect the overall procedure.

**Figure 3**



**Figure 4**

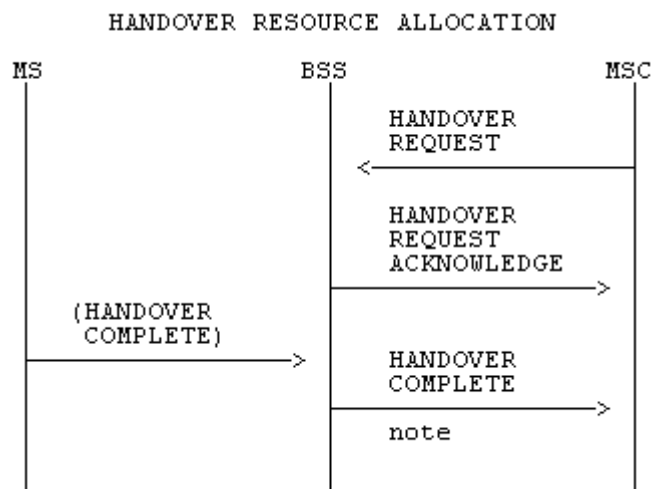

NOTE: The instant of generation of the Handover Complete is described in the text of the present document.

**Figure 5**



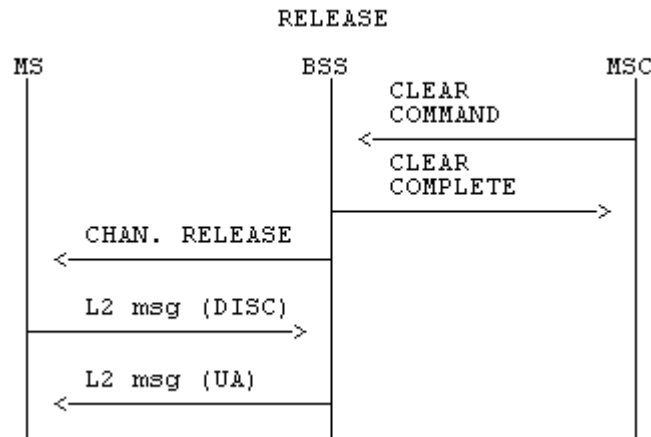

Figure 6

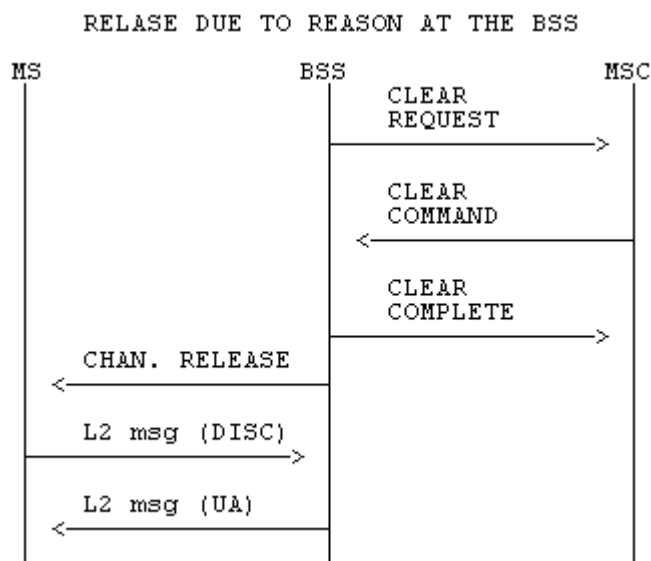

Figure 7

Figure 8: (void)

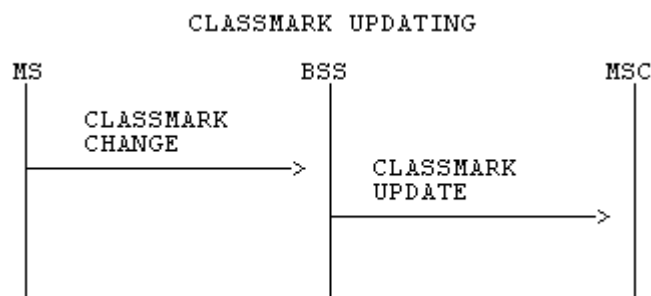

Figure 9

BLOCKING OF TERRESTRIAL CIRCUITS

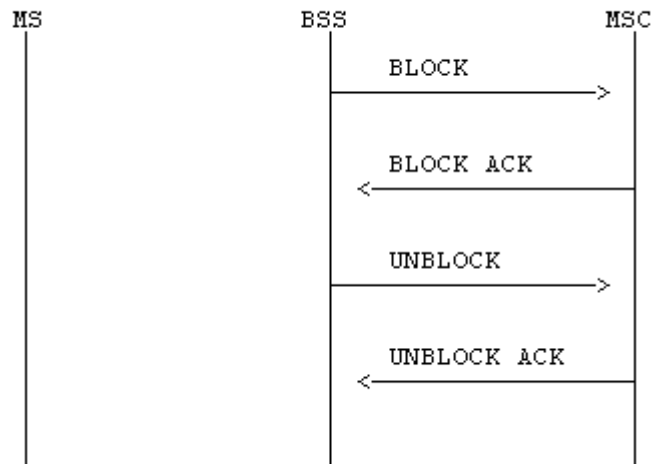

Figure 10

RESET

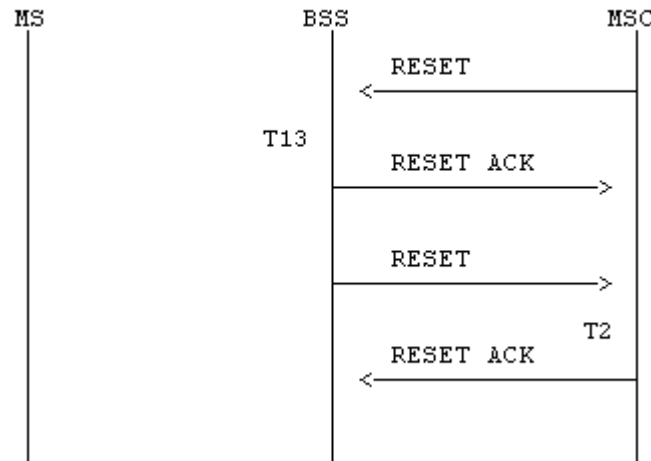

Figure 11

RESOURCE INDICATION

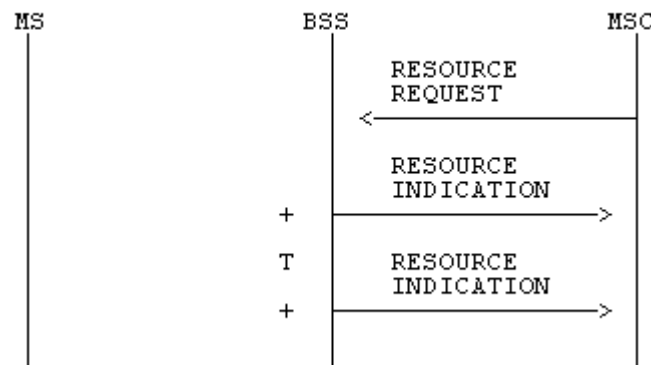
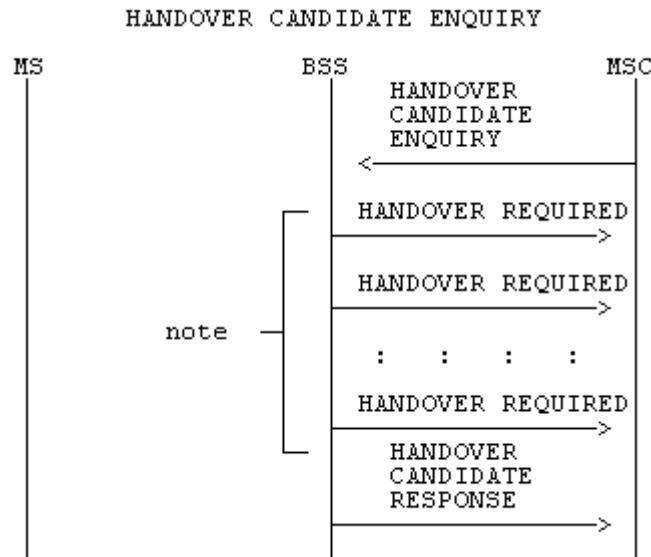

Figure 12



NOTE: Receipt of the Handover Candidate Enquiry Message causes the generation of a Handover Required message for each of candidate MS. These are sent as connection oriented messages. When all Handover Required messages have been generated a global Handover Candidate Response message is returned.

Figure 13

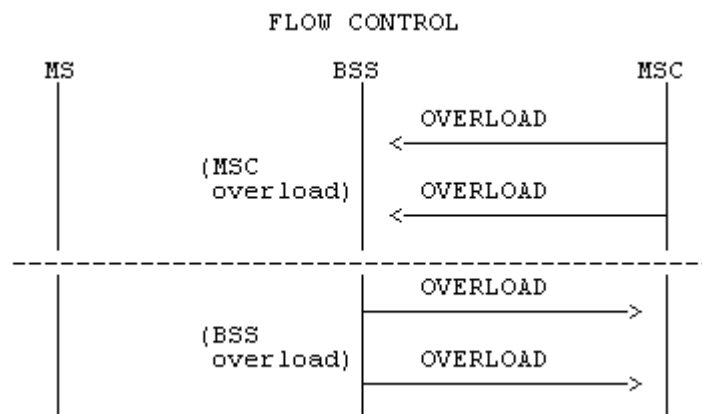

Figure 14

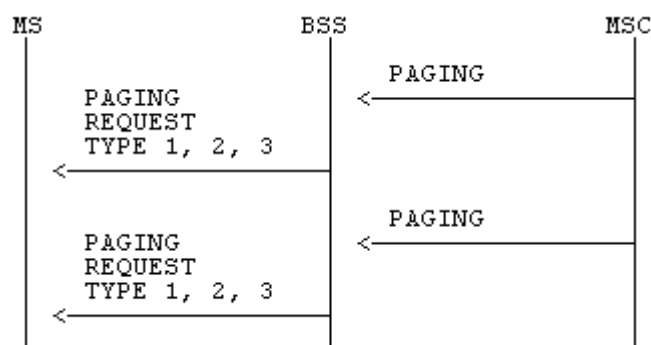
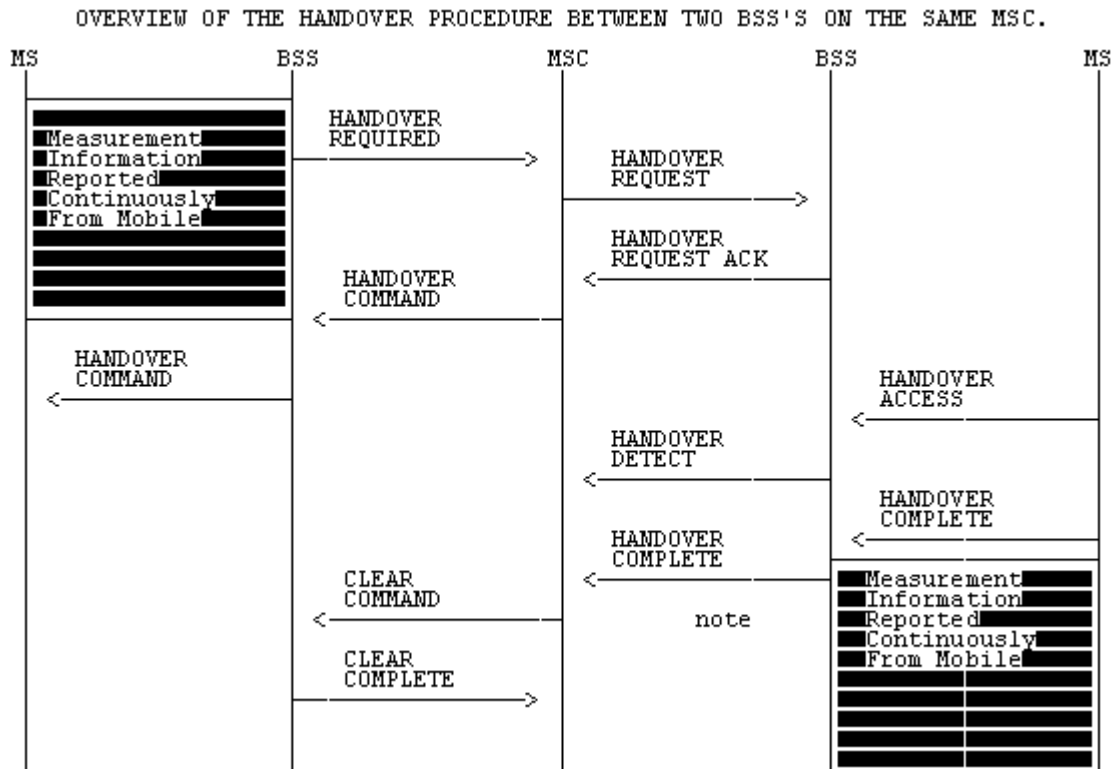

Figure 15



NOTE: The Handover Complete message can be sent as soon as the BSS is certain that the MS has successfully been captured.

Figure 16

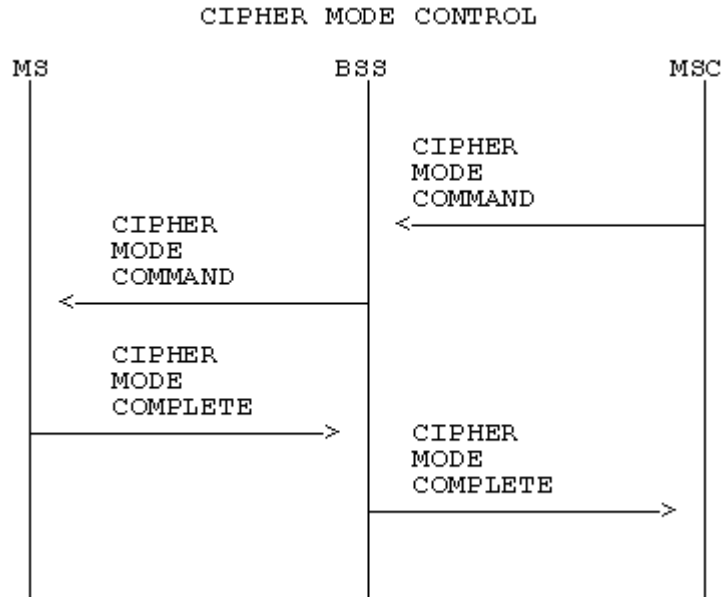
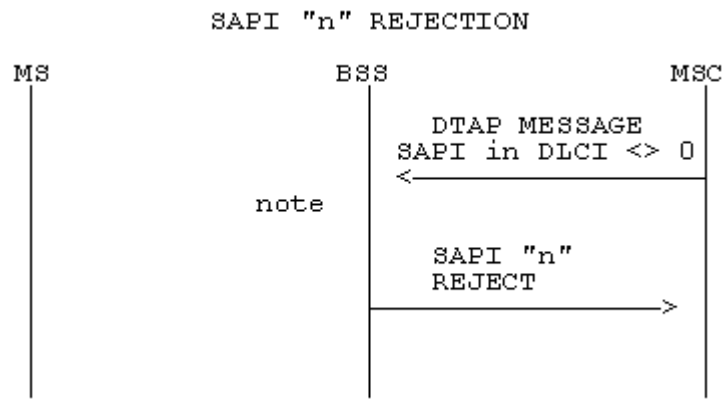

Figure 17



NOTE: The BSS or MS is not equipped for the SAPI request.

Figure 18

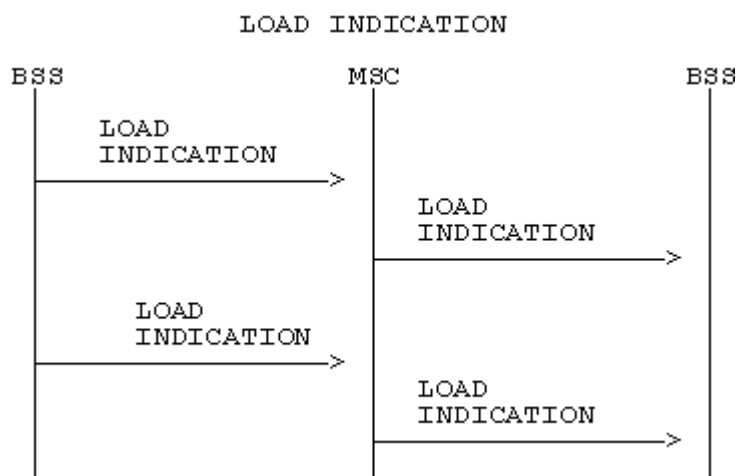

Figure 19

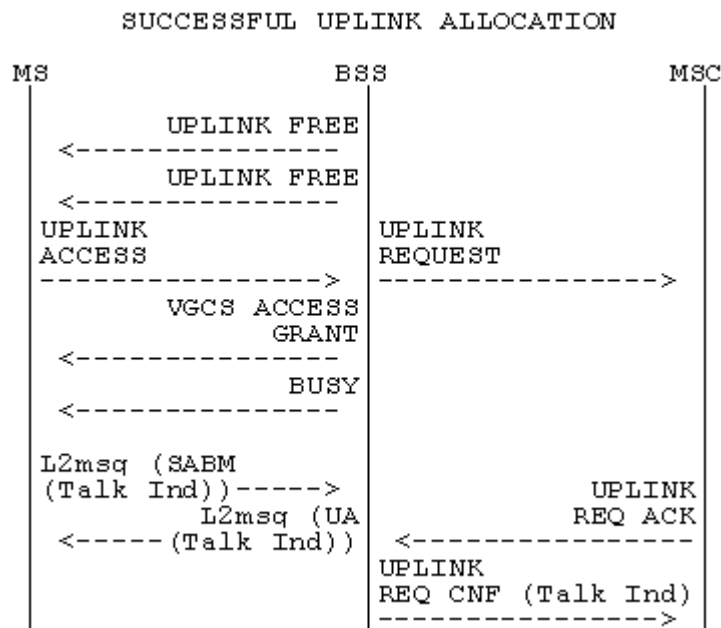

Figure 20

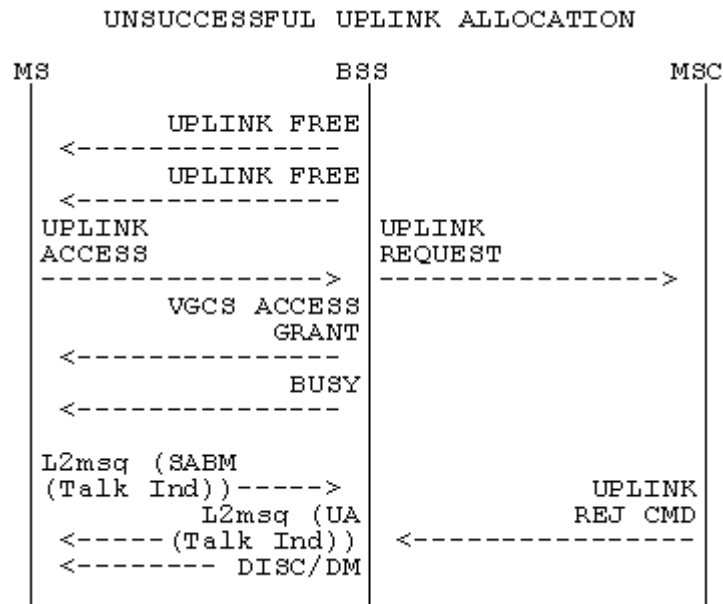

Figure 21

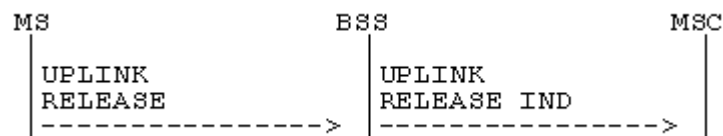

Figure 22

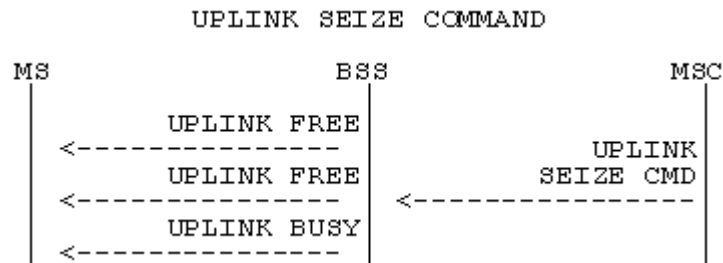

Figure 23

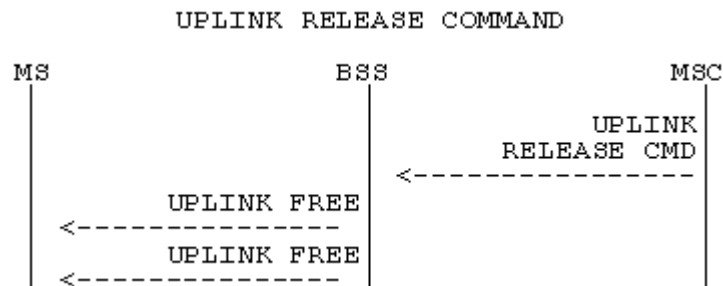

Figure 24

BLOCKING OF TERRESTRIAL CIRCUITS, MSC INITIATED

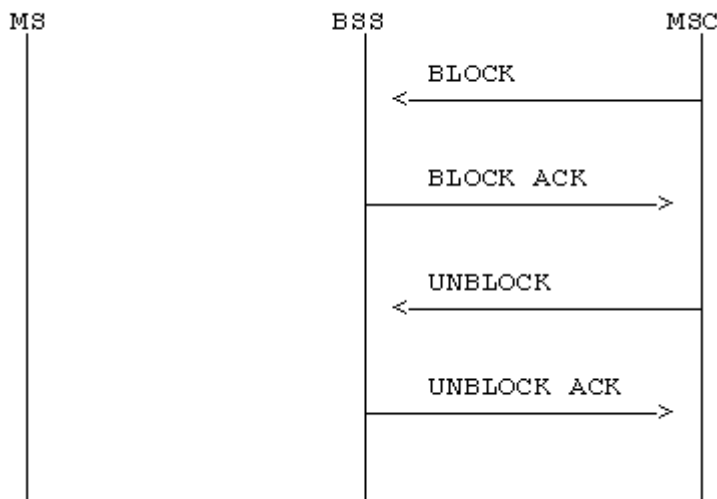

Figure 25

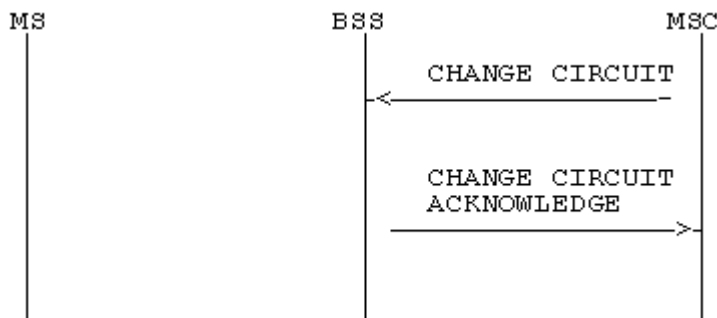

Figure 26

PROCEDURE INTERNAL HANDOVER

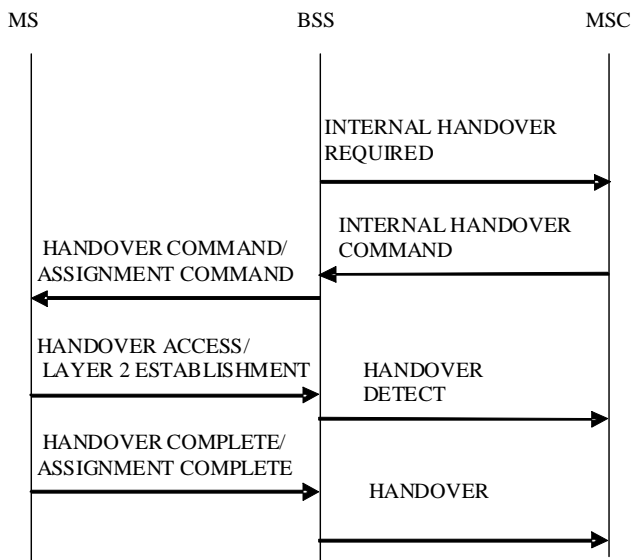

Figure 27

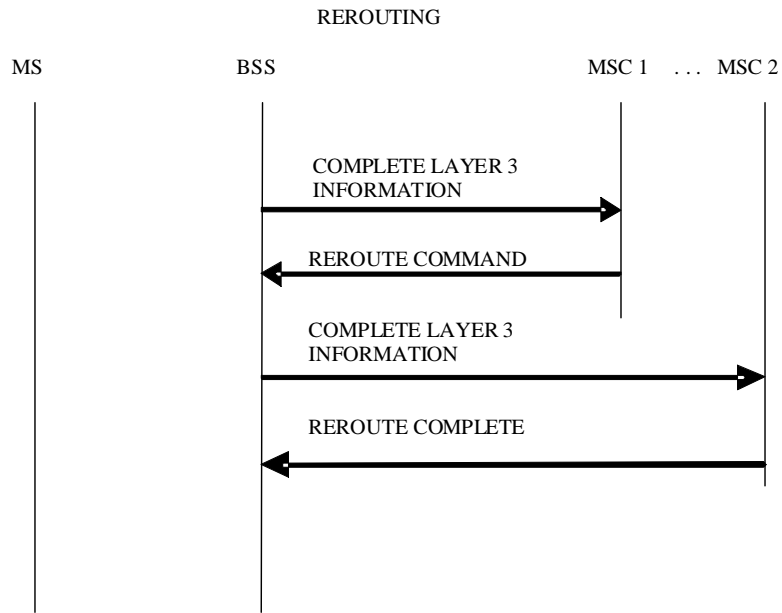

Figure 28



## Annex A (informative): Change History

TSG #	TSG Doc.	CR	Rev	Subject/Comment	New
GP-48	-	-	-	Creation of Rel-10 version based on 9.4.0	10.0.0
GP-48	GP-102037	0325	4	Support of MOCN by GERAN	10.0.0
GP-49	GP-110315	0330	1	Clarification of usage of 'Old BSS to New BSS Information'	10.1.0
GP-49	GP-110303	0333		Clarification of the content of 'Old to New BSS information' IE	10.1.0
GP-49	GP-110350	0339	1	Miscellaneous editorial corrections	10.1.0
GP-50	GP-110826	0324	7	Local Call Local Switch procedures	10.2.0
GP-50	GP-110822	0340	1	Define D-RNTI for Elur-g	10.2.0
GP-51	GP-111339	0343	1	Correction to Local Call Local Switch procedure	10.3.0
GP-51	GP-111336	0341	2	Support for detection of unnecessary IRAT HO	10.3.0
GP-52	GP-111823	0345	1	Clarification of Channel Type IE coding	10.4.0
GP-52	GP-111826	0346	1	Removal of the support for SPID from the A interface	10.4.0
GP-52	GP-111829	0347	2	Introduction of the CSFB Indication on the A interface	10.4.0
GP-52	GP-111828	0348	1	LCLS connection status notification	10.4.0
GP-52	GP-111719	0349		Correction to LCLS procedure when local switching break at handover	10.4.0
GP-52	GP-111874	0350	1	Correction on Unnecessary IRAT HO	10.4.0
GP-52	GP-111835	0352	1	Correction of conditions to send a REROUTE COMMAND	10.4.0

---

## History

<b>Document history</b>		
V10.1.0	March 2011	Publication
V10.2.0	June 2011	Publication
V10.3.0	October 2011	Publication
V10.4.0	January 2012	Publication