

# ETSI TS 148 018 V13.3.1 (2016-11)



**Digital cellular telecommunications system (Phase 2+) (GSM);  
General Packet Radio Service (GPRS);  
Base Station System (BSS)  
- Serving GPRS Support Node (SGSN);  
BSS GPRS protocol (BSSGP)  
(3GPP TS 48.018 version 13.3.1 Release 13)**



---

Reference

RTS/TSGR-0648018vd31

---

Keywords

GSM

**ETSI**

650 Route des Lucioles  
F-06921 Sophia Antipolis Cedex - FRANCE

Tel.: +33 4 92 94 42 00 Fax: +33 4 93 65 47 16

Siret N° 348 623 562 00017 - NAF 742 C  
Association à but non lucratif enregistrée à la  
Sous-Préfecture de Grasse (06) N° 7803/88

---

**Important notice**

The present document can be downloaded from:  
<http://www.etsi.org/standards-search>

The present document may be made available in electronic versions and/or in print. The content of any electronic and/or print versions of the present document shall not be modified without the prior written authorization of ETSI. In case of any existing or perceived difference in contents between such versions and/or in print, the only prevailing document is the print of the Portable Document Format (PDF) version kept on a specific network drive within ETSI Secretariat.

Users of the present document should be aware that the document may be subject to revision or change of status. Information on the current status of this and other ETSI documents is available at  
<https://portal.etsi.org/TB/ETSIDeliverableStatus.aspx>

If you find errors in the present document, please send your comment to one of the following services:  
<https://portal.etsi.org/People/CommiteeSupportStaff.aspx>

---

**Copyright Notification**

No part may be reproduced or utilized in any form or by any means, electronic or mechanical, including photocopying and microfilm except as authorized by written permission of ETSI.

The content of the PDF version shall not be modified without the written authorization of ETSI.  
The copyright and the foregoing restriction extend to reproduction in all media.

© European Telecommunications Standards Institute 2016.  
All rights reserved.

**DECT™**, **PLUGTESTS™**, **UMTS™** and the ETSI logo are Trade Marks of ETSI registered for the benefit of its Members.  
**3GPP™** and **LTE™** are Trade Marks of ETSI registered for the benefit of its Members and of the 3GPP Organizational Partners.  
**GSM®** and the GSM logo are Trade Marks registered and owned by the GSM Association.

---

## Intellectual Property Rights

IPRs essential or potentially essential to the present document may have been declared to ETSI. The information pertaining to these essential IPRs, if any, is publicly available for **ETSI members and non-members**, and can be found in ETSI SR 000 314: *"Intellectual Property Rights (IPRs); Essential, or potentially Essential, IPRs notified to ETSI in respect of ETSI standards"*, which is available from the ETSI Secretariat. Latest updates are available on the ETSI Web server (<https://ipr.etsi.org>).

Pursuant to the ETSI IPR Policy, no investigation, including IPR searches, has been carried out by ETSI. No guarantee can be given as to the existence of other IPRs not referenced in ETSI SR 000 314 (or the updates on the ETSI Web server) which are, or may be, or may become, essential to the present document.

---

## Foreword

This Technical Specification (TS) has been produced by ETSI 3rd Generation Partnership Project (3GPP).

The present document may refer to technical specifications or reports using their 3GPP identities, UMTS identities or GSM identities. These should be interpreted as being references to the corresponding ETSI deliverables.

The cross reference between GSM, UMTS, 3GPP and ETSI identities can be found under <http://webapp.etsi.org/key/queryform.asp>.

---

## Modal verbs terminology

In the present document "**shall**", "**shall not**", "**should**", "**should not**", "**may**", "**need not**", "**will**", "**will not**", "**can**" and "**cannot**" are to be interpreted as described in clause 3.2 of the [ETSI Drafting Rules](#) (Verbal forms for the expression of provisions).

"**must**" and "**must not**" are **NOT** allowed in ETSI deliverables except when used in direct citation.

# Contents

Intellectual Property Rights .....	2
Foreword.....	2
Modal verbs terminology.....	2
Foreword.....	14
1 Scope .....	15
2 References .....	15
3 Abbreviations .....	17
3.1 Vocabulary .....	17
4 Logical configuration of the Gb-interface.....	18
4.1 High-level characteristics of the Gb-interface .....	18
4.2 Position of BSSGP within the protocol stack on the Gb-interface .....	18
5 Elements for layer-to-layer communication.....	19
5.1 Definition of service model .....	19
5.2 Service primitives provided by the BSSGP at a BSS .....	21
5.2.1 RL-DL-UNITDATA.ind.....	23
5.2.2 RL-UL-UNITDATA.req.....	23
5.2.3 (void) .....	24
5.2.3a RL-DL-MBMS-UNITDATA.ind .....	24
5.2.3b RL-UL-MBMS-UNITDATA.req .....	24
5.2.4 GMM-PAGING.ind.....	24
5.2.5 GMM-RA-CAPABILITY.ind .....	24
5.2.6 GMM-RA-CAPABILITY-UPDATE.req .....	24
5.2.7 GMM-RA-CAPABILITY-UPDATE.cnf .....	24
5.2.8 GMM-RADIO-STATUS.req.....	24
5.2.9 GMM-SUSPEND.req.....	24
5.2.10 GMM-SUSPEND.cnf.....	24
5.2.11 GMM-RESUME.req.....	24
5.2.12 GMM-RESUME.cnf.....	24
5.2.12a GMM-MS-REGISTRATION-ENQUIRY.req.....	25
5.2.12b GMM-MS-REGISTRATION-ENQUIRY.res .....	25
5.2.13 NM-FLUSH-LL.ind.....	25
5.2.14 NM-FLUSH-LL.res .....	25
5.2.15 NM-LLC-DISCARDED.req.....	25
5.2.16 NM-FLOW-CONTROL-BVC.req.....	25
5.2.17 NM-FLOW-CONTROL-BVC.cnf.....	25
5.2.18 NM-FLOW-CONTROL-MS.req.....	25
5.2.19 NM-FLOW-CONTROL-MS.cnf .....	25
5.2.19a NM-FLOW-CONTROL-PFC.req.....	25
5.2.19b NM-FLOW-CONTROL-PFC.cnf.....	25
5.2.20 NM-STATUS.req .....	26
5.2.21 NM-STATUS.ind .....	26
5.2.22 NM-BVC-BLOCK.req .....	26
5.2.23 NM-BVC-BLOCK.cnf .....	26
5.2.24 NM-BVC-UNBLOCK.req.....	26
5.2.25 NM-BVC-UNBLOCK.cnf.....	26
5.2.26 NM-BVC-RESET.req.....	26
5.2.27 NM-BVC-RESET.res .....	26
5.2.28 NM-BVC-RESET.ind.....	26
5.2.29 NM-BVC-RESET.cnf.....	26
5.2.30 NM-TRACE.ind .....	26
5.2.30a NW-OVERLOAD.ind .....	26
5.2.31 PFM-DOWNLOAD-BSS-PFC.req.....	27

5.2.32	PFM-CREATE-BSS-PFC.ind.....	27
5.2.33	PFM-CREATE-BSS-PFC.res.....	27
5.2.34	PFM-MODIFY-BSS-PFC.req.....	27
5.2.35	(void).....	27
5.2.36	(void).....	27
5.2.37	PFM-MODIFY-BSS-PFC.cnf.....	27
5.2.38	PFM-DELETE-BSS-PFC.ind.....	27
5.2.39	PFM-DELETE-BSS-PFC.res.....	27
5.2.39a	PFM-DELETE-BSS-PFC.req.....	27
5.2.39b	PFM-PS-HANDOVER-REQUIRED.req.....	27
5.2.39c	PFM-PS-HANDOVER-REQUIRED.cnf.....	27
5.2.39d	PFM-PS-HANDOVER-REQUEST.ind.....	28
5.2.39e	PFM-PS-HANDOVER-REQUEST.res.....	28
5.2.39f	PFM-PS-HANDOVER-COMPLETE.req.....	28
5.2.39g	PFM-PS-HANDOVER-CANCEL.req.....	28
5.2.40	LCS-LOCATE.ind.....	28
5.2.41	LCS-LOCATE.res.....	28
5.2.42	LCS-ABORT.ind.....	28
5.2.43	LCS-INFORMATION-TRANSFER.req.....	28
5.2.44	LCS-INFORMATION-TRANSFER.cnf.....	28
5.2.45	RIM-PDU-TRANSFER.req.....	28
5.2.46	RIM-PDU-TRANSFER.ind.....	28
5.2.47	(void).....	29
5.2.48	(void).....	29
5.2.49	(void).....	29
5.2.50	(void).....	29
5.2.51	(void).....	29
5.2.52	(void).....	29
5.2.53	MBMS-SESSION-START-REQUEST.ind.....	29
5.2.54	MBMS-SESSION-START-RESPONSE.res.....	29
5.2.55	MBMS-SESSION-STOP-REQUEST.ind.....	29
5.2.56	MBMS-SESSION-STOP-RESPONSE.res.....	29
5.2.57	MBMS-SESSION-UPDATE-REQUEST.ind.....	29
5.2.58	MBMS-SESSION-UPDATE-RESPONSE.res.....	29
5.3	Service primitives provided by the BSSGP at an SGSN.....	29
5.3.1	BSSGP-DL-UNITDATA.req.....	32
5.3.2	BSSGP-UL-UNITDATA.ind.....	33
5.3.3	(void).....	33
5.3.3a	BSSGP-DL-MBMS-UNITDATA.req.....	33
5.3.3b	BSSGP-UL-MBMS-UNITDATA.ind.....	33
5.3.4	GMM-PAGING.req.....	33
5.3.5	GMM-RA-CAPABILITY.req.....	33
5.3.6	GMM-RA-CAPABILITY-UPDATE.ind.....	33
5.3.7	GMM-RA-CAPABILITY-UPDATE.res.....	33
5.3.8	GMM-RADIO-STATUS.ind.....	33
5.3.9	GMM-SUSPEND.ind.....	33
5.3.10	GMM-RESUME.ind.....	33
5.3.10a	GMM-MS-REGISTRATION-ENQUIRY.ind.....	33
5.3.10b	GMM-MS-REGISTRATION-ENQUIRY.res.....	34
5.3.11	NM-FLUSH-LL.req.....	34
5.3.12	NM-FLUSH-LL.cnf.....	34
5.3.13	NM-LLC-DISCARDED.ind.....	34
5.3.14	NM-FLOW-CONTROL-BVC.ind.....	34
5.3.15	NM-FLOW-CONTROL-MS.ind.....	34
5.3.15a	NM-FLOW-CONTROL-PFC.ind.....	34
5.3.16	NM-STATUS.req.....	34
5.3.17	NM-STATUS.ind.....	34
5.3.18	NM-BVC-BLOCK.ind.....	34
5.3.19	NM-BVC-UNBLOCK.ind.....	34
5.3.20	NM-BVC-RESET.req.....	34
5.3.21	NM-BVC-RESET.res.....	35
5.3.22	NM-BVC-RESET.ind.....	35

5.3.23	NM-BVC-RESET.cnf.....	35
5.3.24	NM-TRACE.req.....	35
5.3.24a	NM-OVERLOAD-START.req.....	35
5.3.25	PFM-DOWNLOAD-BSS-PFC.ind.....	35
5.3.26	PFM-CREATE-BSS-PFC.req.....	35
5.3.27	PFM-CREATE-BSS-PFC.cnf.....	35
5.3.28	PFM-MODIFY-BSS-PFC.ind.....	35
5.3.29	PFM-MODIFY-BSS-PFC.res.....	35
5.3.30	PFM-DELETE-BSS-PFC.req.....	35
5.3.31	PFM-DELETE-BSS-PFC.cnf.....	35
5.3.31a	PFM-DELETE-BSS-PFC.ind.....	36
5.3.31b	PFM-PS-HANDOVER-REQUIRED.ind.....	36
5.3.31c	PFM-PS-HANDOVER-REQUIRED.res.....	36
5.3.31d	PFM-PS-HANDOVER-REQUEST.req.....	36
5.3.31e	PFM-PS-HANDOVER-REQUEST.cnf.....	36
5.3.31f	PFM-PS-HANDOVER-COMPLETE.ind.....	36
5.3.31g	PFM-PS-HANDOVER-CANCEL.ind.....	36
5.3.32	LCS-LOCATE.req.....	36
5.3.33	LCS-LOCATE.cnf.....	36
5.3.34	LCS-ABORT.req.....	36
5.3.35	LCS-INFORMATION-TRANSFER.ind.....	36
5.3.36	LCS-INFORMATION-TRANSFER.res.....	37
5.3.37	RIM-PDU-TRANSFER.req.....	37
5.3.38	RIM-PDU-TRANSFER.ind.....	37
5.3.39	(void).....	37
5.3.40	(void).....	37
5.3.41	(void).....	37
5.3.42	(void).....	37
5.3.43	(void).....	37
5.3.44	(void).....	37
5.3.45	MBMS-SESSION-START-REQUEST.req.....	37
5.3.46	MBMS-SESSION-START-RESPONSE.cnf.....	37
5.3.47	MBMS-SESSION-STOP-REQUEST.req.....	37
5.3.48	MBMS-SESSION-STOP-RESPONSE.cnf.....	37
5.3.49	MBMS-SESSION-UPDATE-REQUEST.req.....	37
5.3.50	MBMS-SESSION-UPDATE-RESPONSE.cnf.....	38
5.4	Primitive parameters.....	38
5.4.1	BSSGP Virtual Connection Identifier (BVCI).....	38
5.4.2	Link Selector Parameter (LSP).....	39
5.4.3	[functional-name] PDU.....	39
5.4.4	Network Service Entity Identifier (NSEI).....	40
5.4.5	BSS Context.....	40
5.4.6	MBMS Service Context.....	40
5.4.7	TLLI.....	40
6	User data and signalling procedures between RL and BSSGP SAPs.....	40
6.1	Downlink UNITDATA procedure.....	40
6.1.1	Abnormal conditions.....	43
6.2	Uplink UNITDATA procedure.....	43
6.2.1	Abnormal conditions.....	44
6.3	RA-CAPABILITY procedure.....	44
6.3.1	Abnormal conditions.....	44
6.4	Downlink MBMS-UNITDATA procedure.....	44
6.5	Uplink MBMS-UNITDATA procedure.....	44
6.6	Rerouting procedure in case of MOCN configuration for network sharing.....	45
6.6.1	General.....	45
6.6.2	Reroute Indication.....	45
6.6.3	Reroute complete.....	47
6.6.4	Abnormal Conditions.....	47
6.7	Rerouting procedure in case of GWCN configuration for network sharing.....	47
6.7.1	General.....	47
6.7.2	Reroute indication.....	47

6.7.3	Reroute complete .....	48
6.7.4	Abnormal Conditions.....	49
7	Signalling procedures between GMM SAPs .....	49
7.1	Paging procedure.....	49
7.1a	Paging procedure for Extended Coverage and eDRX .....	50
7.1a.1	Coverage Class and eDRX information available .....	50
7.1a.2	Coverage Class information not available, eDRX information available .....	51
7.1a.3	Coverage Class information available, eDRX information not available .....	51
7.2	Radio Access Capability Update procedure .....	51
7.2.1	Abnormal conditions.....	51
7.3	Radio Status procedure.....	51
7.4	SUSPEND procedure .....	52
7.4.1	Abnormal conditions.....	53
7.5	RESUME procedure.....	53
7.5.1	Abnormal conditions.....	53
7.6	MS Registration Enquiry.....	54
7.6.1	General.....	54
7.6.2	Registration enquiry.....	54
7.6.3	Registration response.....	54
8	Signalling procedures between NM SAPs .....	54
8.1	FLUSH-LL (logical link) procedure.....	54
8.1.1	Abnormal Conditions.....	56
8.2	Flow Control procedure.....	56
8.2.1	General model of operation .....	56
8.2.2	Mode of operation.....	56
8.2.3	Flow Control of Traffic from an SGSN to BSS.....	57
8.2.3.1	Control of the downlink throughput by the SGSN .....	57
8.2.3.2	Flow Control Conformance Definition .....	58
8.2.3.3	Response time within the SGSN to flow control messages.....	60
8.2.3.4	Frequency of sending BVC or MS or PFC Flow Control PDUs.....	60
8.2.3.5	FLOW-CONTROL PDUs.....	60
8.2.3.6	Condition of Bmax for MS after Initial Flow-Control-BVC.....	61
8.2.4	Flow Control of Uplink Traffic from a BSS to an SGSN .....	61
8.3	BVC blocking and unblocking procedure .....	61
8.3.1	PTP BVC .....	61
8.3.2	Signalling BVC.....	62
8.3.3	Abnormal Conditions.....	62
8.4	BVC-RESET procedure .....	63
8.4.1	Signalling BVC.....	64
8.4.2	PTP BVC .....	64
8.4.3	Abnormal Conditions.....	64
8.5	Trace procedure.....	65
8.6	Overload Control procedure .....	65
8.6.1	General.....	65
8.6.2	Overload Operation.....	65
8a	Signalling procedures between PFM SAPs .....	66
8a.1	Create BSS PFC procedure .....	66
8a.1.0	General.....	66
8a.1.0a	Allocation/Retention Priority handling.....	67
8a.1.1	Abnormal conditions.....	68
8a.2	Modify BSS PFC procedure.....	68
8a.2.1	Abnormal conditions.....	69
8a.3	Delete BSS PFC procedure .....	69
8a.4	PS Handover Required procedure .....	69
8a.4.1	Abnormal conditions.....	71
8a.5	PS Handover Request procedure .....	71
8a.5.1	Abnormal conditions.....	72
8a.6	PS Handover Complete procedure .....	73
8a.6.1	Abnormal conditions.....	74
8a.7	PS Handover Cancel procedure.....	74

8a.7.1	Abnormal conditions.....	75
8b	Signalling Procedures between LCS SAPs .....	75
8b.1	Location Procedure.....	75
8b.1.1	Unsuccessful Operation .....	75
8b.1.2	Abnormal Conditions.....	76
8b.1.3	Overload .....	76
8b.2	Position Command Procedure .....	76
8b.2.1	Position Command.....	76
8b.2.2	Position Response .....	76
8b.2.3	Unsuccessful Operation .....	77
8c	Signalling procedures between RIM SAPs .....	77
8c.1	General .....	77
8c.1.1	Introduction.....	77
8c.1.2	Definitions .....	77
8c.1.2.1	Controlling and serving nodes.....	77
8c.1.2.2	RIM association .....	78
8c.1.2.3	RIM variables.....	78
8c.1.3	RIM PDUs description.....	78
8c.1.3.1	RAN-INFORMATION-REQUEST PDU .....	78
8c.1.3.2	RAN-INFORMATION PDU .....	78
8c.1.3.3	RAN-INFORMATION-ACK PDU .....	79
8c.1.3.4	RAN-INFORMATION-ERROR PDU.....	79
8c.1.3.5	RAN-INFORMATION-APPLICATION-ERROR PDU .....	79
8c.1.4	RIM addressing and routing principles.....	79
8c.1.4.1	RIM routing address.....	79
8c.1.4.1.1	GERAN BSS identification .....	79
8c.1.4.1.2	UTRAN RNS identification .....	79
8c.1.4.1.3	E-UTRAN eNodeB identification .....	79
8c.1.4.1.4	eHRPD eAN identification.....	79
8c.1.4.2	Routing via the core network .....	80
8c.1.4.3	Address mirroring .....	80
8c.1.5	In-order delivery and reliable transfer - RSN .....	80
8c.1.5.1	General .....	80
8c.1.5.2	Allocating RSN values at the sending BSS.....	81
8c.1.5.3	Comparing RSN values at the receiving BSS .....	81
8c.1.6	RIM Protocol Version Number.....	81
8c.2	RIM procedures.....	82
8c.2.1	General.....	82
8c.2.2	RAN Information Request procedure .....	82
8c.2.2.1	RAN Information Request/Single Report procedure .....	82
8c.2.2.1.1	Initiation by the controlling BSS .....	82
8c.2.2.1.2	Reception of a valid RAN-INFORMATION-REQUEST/Single Report PDU by the serving BSS .....	83
8c.2.2.1.3	Reception of a valid RAN-INFORMATION/Single Report PDU by the controlling BSS .....	83
8c.2.2.1.4	Expiration of T(RIR) in the controlling BSS.....	83
8c.2.2.2	RAN Information Request/Multiple Report procedure.....	83
8c.2.2.2.1	Initiation by the controlling BSS .....	84
8c.2.2.2.2	Reception of a valid RAN-INFORMATION-REQUEST/Multiple Report PDU by the serving BSS .....	84
8c.2.2.2.3	Reception of a valid RAN-INFORMATION PDU/Initial Multiple Report PDU by the controlling BSS .....	85
8c.2.2.2.4	Expiration of T(RIR) in the controlling BSS.....	85
8c.2.2.3	RAN Information Request/Stop procedure .....	85
8c.2.2.3.1	Initiation by the controlling BSS .....	85
8c.2.2.3.2	Reception of a valid RAN-INFORMATION-REQUEST/Stop PDU by the serving BSS .....	85
8c.2.2.3.3	Reception of a valid RAN-INFORMATION/Stop PDU by the controlling BSS.....	86
8c.2.2.3.4	Expiration of T(RIR) in the controlling BSS.....	86
8c.2.3	RAN Information Send procedure .....	87
8c.2.3.1	Initiation by the serving BSS .....	87
8c.2.3.2	Reception of a valid RAN-INFORMATION PDU by the controlling BSS.....	88



8c.2.3.3	Reception of a valid RAN-INFORMATION-ACK PDU in the serving BSS.....	88
8c.2.3.4	Expiration of T(RI) in the serving BSS.....	88
8c.2.4	RAN Information Application Error procedure.....	89
8c.2.4.1	Initiation by the controlling BSS.....	89
8c.2.4.2	Reception of a valid RAN-INFORMATION-APPLICATION-ERROR PDU by the serving BSS.....	89
8c.2.4.3	Reception of a valid RAN-INFORMATION-ACK PDU by the controlling BSS.....	90
8c.2.4.4	Expiration of T(RIAE) in the controlling BSS.....	90
8c.2.5	RAN Information Error procedure.....	90
8c.3	Abnormal conditions.....	90
8c.3.0	General.....	90
8c.3.1	Abnormal conditions at the BSSGP level.....	91
8c.3.1.1	General.....	91
8c.3.1.2	RIM addressing error in BSS.....	91
8c.3.1.3	RIM addressing error in the CN.....	91
8c.3.1.4	RIM PDU addressed to a BSS not supporting RIM.....	91
8c.3.2	Abnormal conditions encountered in the RIM container.....	91
8c.3.2.1	Unknown RIM Application Identity.....	91
8c.3.2.2	Erroneous PDU Type Extension field.....	91
8c.3.2.3	Missing conditional IE.....	92
8c.3.2.4	Missing mandatory IE.....	92
8c.3.2.5	Syntactical error in an expected conditional IE.....	92
8c.3.2.6	Syntactical error in a mandatory IE.....	92
8c.3.2.7	Unexpected conditional IE.....	92
8c.3.2.8	Containers with out-of-sequence information elements.....	93
8c.3.2.9	Container with semantically incorrect content.....	93
8c.3.3	Unexpected RIM PDU.....	93
8c.3.4	RIM error reporting.....	93
8c.3.4.1	General.....	93
8c.3.4.2	Sending of a RAN-INFORMATION-ERROR PDU.....	93
8c.3.4.3	Reception of a RAN-INFORMATION-ERROR PDU in the BSS.....	93
8c.4	RIM timers.....	94
8c.5	Action upon deletion of a cell in a BSS.....	94
8c.5.0	General.....	94
8c.5.1	Actions due to the deletion of the cell.....	94
8c.5.2	Additional actions in the case the deleted cell is used as a source cell by RIM.....	95
8c.6	Specific requirements related to RIM applications.....	95
8c.6.0	General requirements.....	95
8c.6.1	Requirements related to the NACC RIM application.....	95
8c.6.2	SI3 application.....	96
8c.6.3	MBMS data channel application.....	96
8c.6.4	Requirements related to the SON Transfer RIM application.....	97
8c.6.5	Requirements related to the UTRA SI RIM application.....	97
8d	Signalling procedures between MBMS SAPs.....	98
8d.1	General.....	98
8d.2	MBMS Session Start.....	98
8d.2.1	Abnormal Conditions.....	100
8d.3	MBMS Session Stop.....	100
8d.3.1	Abnormal Conditions.....	100
8d.4	MBMS Session Update.....	100
8d.4.1	Abnormal Conditions.....	102
9	General Protocol Error Handling.....	102
10	PDU functional definitions and contents.....	102
10.1	General Structure Of A PDU.....	102
10.2	PDU functional definitions and contents at RL and BSSGP SAPs.....	103
10.2.1	DL-UNITDATA.....	103
10.2.2	UL-UNITDATA.....	104
10.2.3	RA-CAPABILITY.....	105
10.2.4	(void).....	106
10.2.5	DL-MBMS-UNITDATA.....	106
10.2.6	UL-MBMS-UNITDATA.....	106

10.3	PDU functional definitions and contents at GMM SAP .....	106
10.3.1	PAGING PS .....	106
10.3.2	PAGING CS .....	108
10.3.3	RA-CAPABILITY-UPDATE .....	108
10.3.4	RA-CAPABILITY-UPDATE-ACK .....	109
10.3.5	RADIO-STATUS .....	109
10.3.6	SUSPEND .....	109
10.3.7	SUSPEND-ACK .....	110
10.3.8	SUSPEND-NACK .....	110
10.3.9	RESUME .....	110
10.3.10	RESUME-ACK .....	111
10.3.11	RESUME-NACK .....	111
10.3.12	DUMMY PAGING PS .....	111
10.3.13	DUMMY PAGING PS RESPONSE .....	112
10.3.14	PAGING PS REJECT .....	112
10.3.15	MS REGISTRATION ENQUIRY .....	112
10.3.16	MS REGISTRATION ENQUIRY RESPONSE .....	112
10.4	PDU functional definitions and contents at NM SAP .....	113
10.4.1	FLUSH-LL .....	113
10.4.2	FLUSH-LL-ACK .....	113
10.4.3	LLC-DISCARDED .....	114
10.4.4	FLOW-CONTROL-BVC .....	114
10.4.5	FLOW-CONTROL-BVC-ACK .....	114
10.4.6	FLOW-CONTROL-MS .....	115
10.4.7	FLOW-CONTROL-MS-ACK .....	115
10.4.8	BVC-BLOCK .....	115
10.4.9	BVC-BLOCK-ACK .....	116
10.4.10	BVC-UNBLOCK .....	116
10.4.11	BVC-UNBLOCK-ACK .....	116
10.4.12	BVC-RESET .....	117
10.4.13	BVC-RESET-ACK .....	117
10.4.14	STATUS .....	118
10.4.14.1	Static conditions for BVCI .....	118
10.4.15	SGSN-INVOKE-TRACE .....	118
10.4.16	DOWNLOAD-BSS-PFC .....	119
10.4.17	CREATE-BSS-PFC .....	119
10.4.18	CREATE-BSS-PFC-ACK .....	119
10.4.19	CREATE-BSS-PFC-NACK .....	120
10.4.20	MODIFY-BSS-PFC .....	120
10.4.21	MODIFY-BSS-PFC-ACK .....	120
10.4.22	DELETE-BSS-PFC .....	121
10.4.23	DELETE-BSS-PFC-ACK .....	121
10.4.24	FLOW-CONTROL-PFC .....	121
10.4.25	FLOW-CONTROL-PFC-ACK .....	122
10.4.26	DELETE-BSS-PFC-REQ .....	122
10.4.27	PS-HANDOVER-REQUIRED .....	122
10.4.28	PS-HANDOVER-REQUIRED-ACK .....	123
10.4.29	PS-HANDOVER-REQUIRED-NACK .....	123
10.4.30	PS-HANDOVER-REQUEST .....	124
10.4.31	PS-HANDOVER-REQUEST-ACK .....	124
10.4.32	PS-HANDOVER-REQUEST-NACK .....	125
10.4.33	PS-HANDOVER-COMPLETE .....	125
10.4.34	PS-HANDOVER-CANCEL .....	125
10.4.35	PS-HANDOVER-COMPLETE-ACK .....	126
10.5	PDU functional definitions and contents at LCS SAP .....	126
10.5.1	PERFORM-LOCATION-REQUEST .....	126
10.5.2	PERFORM-LOCATION-RESPONSE .....	128
10.5.3	PERFORM-LOCATION-ABORT .....	128
10.5.4	POSITION-COMMAND .....	128
10.5.5	POSITION-RESPONSE .....	129
10.6	PDU functional definitions and contents at RIM SAP .....	129
10.6.1	RAN-INFORMATION-REQUEST .....	129

10.6.2	RAN-INFORMATION.....	130
10.6.3	RAN-INFORMATION-ACK.....	130
10.6.4	RAN-INFORMATION-ERROR.....	130
10.6.5	RAN-INFORMATION-APPLICATION-ERROR.....	131
10.7	PDU functional definitions and contents at MBMS SAP.....	131
10.7.1	MBMS-SESSION-START-REQUEST.....	131
10.7.2	MBMS-SESSION-START-RESPONSE.....	132
10.7.3	MBMS-SESSION-STOP-REQUEST.....	132
10.7.4	MBMS-SESSION-STOP-RESPONSE.....	132
10.7.5	MBMS-SESSION-UPDATE-REQUEST.....	132
10.7.6	MBMS-SESSION-UPDATE-RESPONSE.....	133
11	General information elements coding.....	133
11.1	General structure of the information elements.....	133
11.2	Information element description.....	133
11.3	Information Element Identifier (IEI).....	134
11.3.1	Alignment octets.....	136
11.3.2	Bmax default MS.....	136
11.3.3	BSS Area Indication.....	136
11.3.4	Bucket Leak Rate (R).....	137
11.3.5	BVC Bucket Size.....	137
11.3.6	BVCI (BSSGP Virtual Connection Identifier).....	137
11.3.7	BVC Measurement.....	138
11.3.8	Cause.....	138
11.3.9	Cell Identifier.....	140
11.3.10	Channel needed.....	140
11.3.11	DRX Parameters.....	140
11.3.12	eMLPP-Priority.....	140
11.3.13	Flush Action.....	141
11.3.14	IMSI.....	141
11.3.15	LLC-PDU.....	141
11.3.16	LLC Frames Discarded.....	142
11.3.17	Location Area.....	142
11.3.18	LSA Identifier List.....	142
11.3.19	LSA Information.....	142
11.3.20	Mobile Id.....	142
11.3.21	MS Bucket Size.....	143
11.3.22	MS Radio Access Capability.....	143
11.3.23	OMC Id.....	143
11.3.24	PDU In Error.....	143
11.3.25	PDU Lifetime.....	144
11.3.26	PDU Type.....	145
11.3.27	Priority.....	146
11.3.28	QoS Profile.....	146
11.3.29	Radio Cause.....	148
11.3.30	RA-Cap-UPD-Cause.....	148
11.3.31	Routeing Area.....	149
11.3.32	R_default_MS.....	149
11.3.33	Suspend Reference Number.....	149
11.3.34	Tag.....	149
11.3.35	Temporary logical link Identity (TLLI).....	150
11.3.36	Temporary Mobile Subscriber Identity (TMSI).....	150
11.3.37	Trace Reference.....	150
11.3.38	Trace Type.....	150
11.3.39	Transaction Id.....	151
11.3.40	Trigger Id.....	151
11.3.41	Number of octets affected.....	151
11.3.42	Packet Flow Identifier (PFI).....	151
11.3.42a	(void).....	152
11.3.43	Aggregate BSS QoS Profile.....	152
11.3.44	GPRS Timer.....	152
11.3.45	Feature Bitmap.....	152

11.3.46	Bucket Full Ratio .....	154
11.3.47	Service UTRAN CCO .....	154
11.3.48	NSEI (Network Service Entity Identifier) .....	155
11.3.49	RRLP APDU .....	155
11.3.50	LCS QoS .....	155
11.3.51	LCS Client Type .....	155
11.3.52	Requested GPS Assistance Data .....	156
11.3.53	Location Type .....	156
11.3.54	Location Estimate .....	156
11.3.55	Positioning Data .....	156
11.3.56	Deciphering Keys .....	157
11.3.57	LCS Priority .....	157
11.3.58	LCS Cause .....	157
11.3.59	LCS Capability .....	157
11.3.60	RRLP Flags .....	157
11.3.61	RIM Application Identity .....	158
11.3.62	RIM Sequence Number .....	159
11.3.62a	RIM Container .....	159
11.3.62a.0	General .....	159
11.3.62a.1	RAN-INFORMATION-REQUEST RIM Container .....	159
11.3.62a.2	RAN-INFORMATION RIM Container .....	160
11.3.62a.3	RAN-INFORMATION-ACK RIM Container .....	160
11.3.62a.4	RAN-INFORMATION-ERROR RIM Container .....	161
11.3.62a.5	RAN-INFORMATION-APPLICATION-ERROR RIM Container .....	161
11.3.63	Application Container .....	162
11.3.63.1	RAN-INFORMATION-REQUEST Application Container .....	162
11.3.63.1.0	General .....	162
11.3.63.1.1	RAN-INFORMATION-REQUEST Application Container for the NACC Application .....	162
11.3.63.1.2	RAN-INFORMATION-REQUEST Application Container for the SI3 Application .....	162
11.3.63.1.3	RAN-INFORMATION-REQUEST Application Container for the MBMS data channel Application .....	162
11.3.63.1.4	RAN-INFORMATION-REQUEST Application Container for the SON Transfer Application ...	163
11.3.63.1.5	RAN-INFORMATION-REQUEST Application Container for the UTRA SI Application .....	163
11.3.63.2	RAN-INFORMATION Application Container Unit .....	164
11.3.63.2.0	General .....	164
11.3.63.2.1	RAN-INFORMATION Application Container for the NACC Application .....	164
11.3.63.2.2	RAN-INFORMATION Application Container for the SI3 Application .....	165
11.3.63.2.3	RAN-INFORMATION Application Container for the MBMS data channel Application .....	165
11.3.63.2.4	RAN-INFORMATION Application Container for the SON Transfer Application .....	167
11.3.63.2.5	RAN-INFORMATION Application Container for the UTRA SI Application .....	167
11.3.64	Application Error Container .....	168
11.3.64.1	Application Error Container layout for the NACC application .....	168
11.3.64.2	Application Error Container for the SI3 application .....	168
11.3.64.3	Application Error Container for the MBMS data channel application .....	169
11.3.64.4	Application Error Container for the SON Transfer Application .....	170
11.3.64.5	Application Error Container for the UTRA SI Application .....	170
11.3.65	RIM PDU Indications .....	171
11.3.65.0	General .....	171
11.3.65.1	RAN-INFORMATION-REQUEST RIM PDU Indications .....	171
11.3.65.2	RAN-INFORMATION RIM PDU Indications .....	171
11.3.65.3	RAN-INFORMATION-APPLICATION-ERROR RIM PDU Indications .....	172
11.3.66	(void) .....	172
11.3.67	RIM Protocol Version Number .....	172
11.3.68	PFC Flow Control parameters .....	173
11.3.69	Global CN-Id .....	173
11.3.70	RIM Routing Information .....	174
11.3.71	MBMS Session Identity .....	175
11.3.72	MBMS Session Duration .....	175
11.3.73	MBMS Service Area Identity List .....	176
11.3.74	MBMS Response .....	176
11.3.75	MBMS Routing Area List .....	177
11.3.76	MBMS Session Information .....	177

11.3.77	TMGI (Temporary Mobile Group Identity).....	178
11.3.78	MBMS Stop Cause .....	178
11.3.79	Source BSS to Target BSS Transparent Container .....	179
11.3.80	Target BSS to Source BSS Transparent Container .....	179
11.3.81	NAS container for PS Handover .....	180
11.3.82	PFCs to be set-up list .....	180
11.3.83	List of set-up PFCs .....	181
11.3.84	Extended Feature Bitmap.....	182
11.3.85	Source to Target Transparent Container .....	183
11.3.86	Target to Source Transparent Container .....	183
11.3.87	RNC Identifier .....	183
11.3.88	Page Mode .....	184
11.3.89	Container ID .....	184
11.3.90	Global TFI .....	184
11.3.91	IMEI.....	185
11.3.92	Time to MBMS Data Transfer.....	185
11.3.93	MBMS Session Repetition Number.....	185
11.3.94	Inter RAT Handover Info .....	186
11.3.95	PS Handover Command.....	186
11.3.95a	PS Handover Indications .....	186
11.3.95b	SI/PSI Container .....	187
11.3.95c	Active PFCs List.....	188
11.3.96	Velocity Data .....	188
11.3.97	DTM Handover Command .....	188
11.3.98	CS Indication .....	189
11.3.99	Requested GANSS Assistance Data .....	189
11.3.100	GANSS Location Type .....	189
11.3.101	GANSS Positioning Data.....	189
11.3.102	Flow Control Granularity.....	190
11.3.103	eNB Identifier .....	190
11.3.104	E-UTRAN Inter RAT Handover Info .....	191
11.3.105	Subscriber Profile ID for RAT/Frequency priority .....	191
11.3.106	Request for Inter-RAT Handover Info.....	191
11.3.107	Reliable Inter-RAT Handover Info .....	192
11.3.108	SON Transfer Application Identity.....	192
11.3.109	CSG Identifier.....	192
11.3.110	Tracking Area Code.....	193
11.3.111	Redirect Attempt Flag.....	193
11.3.112	Redirection Indication.....	193
11.3.113	Redirection Completed .....	194
11.3.114	Unconfirmed send state variable.....	195
11.3.115	IRAT Measurement Configuration .....	195
11.3.116	SCI.....	196
11.3.117	GGSN/P-GW location .....	196
11.3.118	Selected PLMN ID.....	197
11.3.119	Priority Class Indicator .....	197
11.3.120	Source Cell ID IE.....	197
11.3.121	IRAT Measurement Configuration (extended E-ARFCNs).....	198
11.3.122	eDRX Parameters .....	199
11.3.123	Time Until Next Paging Occasion .....	199
11.3.124	Coverage Class .....	200
11.3.125	Paging Attempt Information .....	200
11.3.126	Exception Report Flag .....	201
11.3.127	Old Routing Area Identification .....	201
11.3.128	Attach Indicator .....	202
11.3.129	PLMN Identity.....	202
11.3.130	MME Query.....	202
12	List of system variables .....	203
12.1	General Variables .....	203
12.2	Flow control variables .....	203

**Annex A (informative):**    **Change history** .....205  
History .....206

---

# Foreword

This Technical Specification has been produced by the 3<sup>rd</sup> Generation Partnership Project (3GPP).

The present document specifies or references procedures used on the Base Station System (BSS) to Serving GPRS Support Node (SGSN) interface for control of GSM packet data services within the digital cellular telecommunications system (Phase 2+).

The contents of the present document are subject to continuing work within the TSG and may change following formal TSG approval. Should the TSG modify the contents of the present document, it will be re-released by the TSG with an identifying change of release date and an increase in version number as follows:

Version x.y.z

where:

- x the first digit:
  - 1 presented to TSG for information;
  - 2 presented to TSG for approval;
  - 3 or greater indicates TSG approved document under change control.
- y the second digit is incremented for all changes of substance, i.e. technical enhancements, corrections, updates, etc.
- z the third digit is incremented when editorial only changes have been incorporated in the document.

---

# 1 Scope

The present document specifies or references procedures used on the Base Station System (BSS) to Serving GPRS Support Node (SGSN) interface for control of GSM packet data services.

The functional split between BSS and SGSN is defined in 3GPP TS 23.060 which states that a BSS is responsible for local radio resource allocation. The required procedures between BSS and SGSN are defined in detail in the present document.

---

# 2 References

The following documents contain provisions which, through reference in this text, constitute provisions of the present document.

- References are either specific (identified by date of publication, edition number, version number, etc.) or non-specific.
- For a specific reference, subsequent revisions do not apply.
- For a non-specific reference, the latest version applies. In the case of a reference to a 3GPP document (including a GSM document), a non-specific reference implicitly refers to the latest version of that document *in the same Release as the present document*.

- [1] 3GPP TR 21.905: "Vocabulary for 3GPP Specifications".
- [2] (void).
- [3] (void).
- [4] (void).
- [5] (void).
- [6] (void).
- [7] 3GPP TS 23.060: "General Packet Radio Service (GPRS); Service Description; Stage 2".
- [8] (void).
- [9] (void).
- [10] 3GPP TS 43.064: "Overall description of the GPRS radio interface; Stage 2".
- [11] 3GPP TS 24.008: "Mobile radio interface Layer 3 specification; Core network protocols; Stage 3".
- [12] 3GPP TS 44.064: "Mobile Station - Serving GPRS Support Node (MS-SGSN) Logical Link Control (LLC) Layer Specification".
- [13] (void).
- [14] 3GPP TS 48.008: "Mobile Switching Centre - Base Station System (MSC-BSS) interface; Layer 3 specification".
- [15] (void).
- [16] 3GPP TS 48.016: "General Packet Radio Service (GPRS); Base Station System (BSS) - Serving GPRS Support Node (SGSN) interface; Network Service"
- [17] 3GPP TS 29.018: "General Packet Radio Service (GPRS); Serving GPRS Support Node (SGSN) - Visitors Location Register (VLR); Gs Interface Layer 3 specification".
- [18] 3GPP TS 32.008: "Subscriber and equipment trace".



- [19] ITU-T Recommendation X.200 (White Book): "Information technology - Open Systems Interconnection - Basic Reference Model: The basic model".
- [20] 3GPP TS 23.107: "Quality of Service (QoS) concept and architecture".
- [21] (void).
- [22] 3GPP TS 44.060: "General Packet Radio Service (GPRS); Mobile Station (MS) - Base Station System (BSS) interface; Radio Link Control/Medium Access Control (RLC/MAC) protocol".
- [23] 3GPP TS 43.059: "Functional Stage 2 Description of Location Services (LCS) in GERAN".
- [24] 3GPP TS 49.031: "Location Services (LCS); Base Station System Application Part LCS Extension (BSSAP-LE)".
- [25] 3GPP TS 44.018: "Mobile radio interface layer 3 specification; Radio Resource Control Protocol".
- [26] 3GPP TR 44.901: "External Network Assisted Cell Change (NACC)".
- [27] 3GPP TS 23.236: "Intra-domain connection of Radio Access Network (RAN) nodes to multiple Core Network (CN) nodes".
- [28] 3GPP TS 12.20: "Base Station System (BSS) Management Information".
- [29] 3GPP TS 43.246: "Multimedia Broadcast Multicast Service (MBMS) in the GERAN Stage 2".
- [30] 3GPP TS 26.346: "Multimedia Broadcast Multicast Service Protocols and Codecs".
- [31] 3GPP TS 29.061: "Interworking between the Public Land Mobile Network (PLMN) supporting packet based services and Packet Data Networks (PDN)".
- [32] 3GPP TS 23.246: "Multimedia Broadcast/Multicast Service (MBMS) Architecture and Functional Description".
- [33] IETF RFC 3588: "Diameter Base Protocol".
- [34] 3GPP TS 43.129: "Packet-switched handover for GERAN A/Gb mode; Stage 2".
- [35] 3GPP TS 36.331: "Evolved Universal Terrestrial Radio Access (E-UTRA); Radio Resource Control (RRC); Protocol specification".
- [36] 3GPP TS 36.413: "Evolved Universal Terrestrial Radio Access (E-UTRA); S1 Application Protocol (S1AP)".
- [37] 3GPP TS 24.301: "Non-Access-Stratum (NAS) protocol for Evolved Packet System (EPS); Stage3".
- [38] 3GPP TS 25.413: "UTRAN Iu interface Radio Access Network Application Part (RANAP) signalling".
- [39] 3GPP TS 22.220: "Service Requirements for Home NodeBs and Home eNodeBs".
- [40] 3GPP TS 23.003: "Numbering, addressing and identification".
- [41] 3GPP TS 29.060: "GPRS Tunnelling Protocol (GTP) across the Gn and Gp interface".
- [42] 3GPP TS 25.331: "Technical Specification Group Radio Access Network; Radio Resource Control (RRC)".
- [43] 3GPP TS 23.251: "Network sharing - Architecture and functional description".
- [44] 3GPP TS 45.008: "Radio subsystem link control".
- [45] 3GPP TS 36.300: "Evolved Universal Terrestrial Radio Access (E-UTRA) and Evolved Universal Terrestrial Radio Access Network (E-UTRAN); Overall description; Stage 2".

- [46] 3GPP TS 29.281: "General Packet Radio System (GPRS) Tunnelling Protocol User Plane (GTPv1-U)"
- [47] 3GPP2 C.S0024-B: "cdma2000 High Rate Packet Data Air Interface Specification".
- [48] 3GPP TS 45.002: "Technical Specification Group GSM/EDGE Radio Access Network; Multiplexing and multiple access on the radio path"

---

## 3 Abbreviations

For the purposes of the present document, the abbreviations given in 3GPP TR 21.905 and in 3GPP TS 48.016 and the following apply:

ABQP	Aggregate BSS QoS Profile
CBL	Current Bucket Level
CCN	Cell Change Notification
CS	Circuit switched
CSG	Closed Subscriber Group
DL	Downlink
eAN	evolved Access Network
eDRX	Extended Discontinuous Reception
eHRPD	enhanced High Rate Packet Data
eNB	E-UTRAN NodeB
E-UTRA	Evolved UTRA
E-UTRAN	Evolved UTRAN
GWCN	GateWay Core Network
LCS	Location Services
MBMS	Multimedia Broadcast Multicast Service
MME	Mobility Management Entity
MOCN	Multi Operator Core Network
NACC	Network Assisted Cell Change
NRI	Network Resource Identifier
NSE	Network Service Entity
PFC	Packet Flow Context
PFI	Packet Flow Identifier
PFM	Packet Flow Management
PFT	Packet Flow Timer
PS	Packet switched
RAN	Radio Access Network
RIM	RAN Information Management
RRLP	Radio Resource LCS Protocol
RSN	RIM Sequence Number
SIRUG	Service Identification for improved Radio Utilization for GERAN
SON	Self-Organizing Networks
SPID	Subscriber Profile ID for RAT/Frequency priority
TAI	Tracking Area Identity
TMGI	Temporary Mobile Group Identity
TOM	Tunneling of Messages
RIM	RAN Information Management
UL	Uplink

### 3.1 Vocabulary

- **Coverage Class:** See definition in 3GPP TS 43.064 [10].
- **CS/PS coordination enhancements:** refers to an improved CS/PS domain registration coordination function when rerouting is performed in a MOCN or in a GWCN configuration for network sharing. The improved CS/PS domain registration coordination is achieved by extended signalling between the BSS and the CN nodes (see 3GPP TS 23.251 [43]).

- **EC operation:** See definition in 3GPP TS 43.064 [10].
- **Extended DRX (eDRX):** see 3GPP TS 21.905 [1].
- **Network sharing:** network sharing is an optional feature that allows different core network operators to connect to the same shared radio access network in a MOCN configuration, and to the same shared radio access network and core network nodes in a GWCN configuration (see 3GPP TS 23.251 [43]). When network sharing is in use within a given cell, the network broadcasts within system information the PLMN identities of the PLMNs sharing the cell. A mobile station supporting network sharing uses this information for its PLMN (re)selection processes and indicates the selected PLMN to the BSS.

## 4 Logical configuration of the Gb-interface

### 4.1 High-level characteristics of the Gb-interface

In contrast to the A-interface, where a single user has the sole use of a dedicated physical resource throughout the lifetime of a call irrespective of information flow, the Gb-interface allows many users to be multiplexed over a common physical resource.

GPRS signalling and user data may be sent on the same physical resources.

Access rates per user may vary from zero data to the maximum possible bandwidth (e.g. the available bit rate of an E1).

### 4.2 Position of BSSGP within the protocol stack on the Gb-interface

Across the Gb-interface the following peer protocols have been identified: the Base Station Subsystem GPRS Protocol (BSSGP) and the underlying network service (NS). The NS shall transport BSSGP PDUs between a BSS and an SGSN (refer to 3GPP TS 48.016).

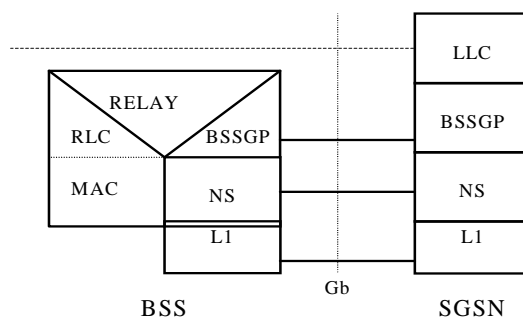

**Figure 4.1: BSSGP's position within the Gb-interface protocol stack**

**NOTE:** The Relay function provides buffering and parameter mapping between the RLC/MAC and the BSSGP.

**EXAMPLE:** On the uplink the RLC/MAC shall provide a TLLI. The Relay function shall then make it available to BSSGP. For a definition of the RLC/MAC function refer to 3GPP TS 43.064.

The primary functions of the BSSGP include:

- in the downlink, the provision by an SGSN to a BSS of radio related information used by the RLC/MAC function;
- in the uplink, the provision by a BSS to an SGSN of radio related information derived from the RLC/MAC function; and

- the provision of functionality to enable two physically distinct nodes, an SGSN and a BSS, to operate node management control functions.

The present document describes the service model, service primitives, procedures and PDU formats of the BSSGP.

## 5 Elements for layer-to-layer communication

### 5.1 Definition of service model

In the present document, the communication between adjacent layers and the services provided by the layers are distributed by use of abstract service primitives. Only externally observable behaviour resulting from the description is normatively prescribed by the present document.

The service primitive model used in the present document is based on the concepts developed in ITU-T Recommendation X.200.

The service model for a BSS and an SGSN is asymmetric. The service models for a BSS and an SGSN are shown in figure 5.1.

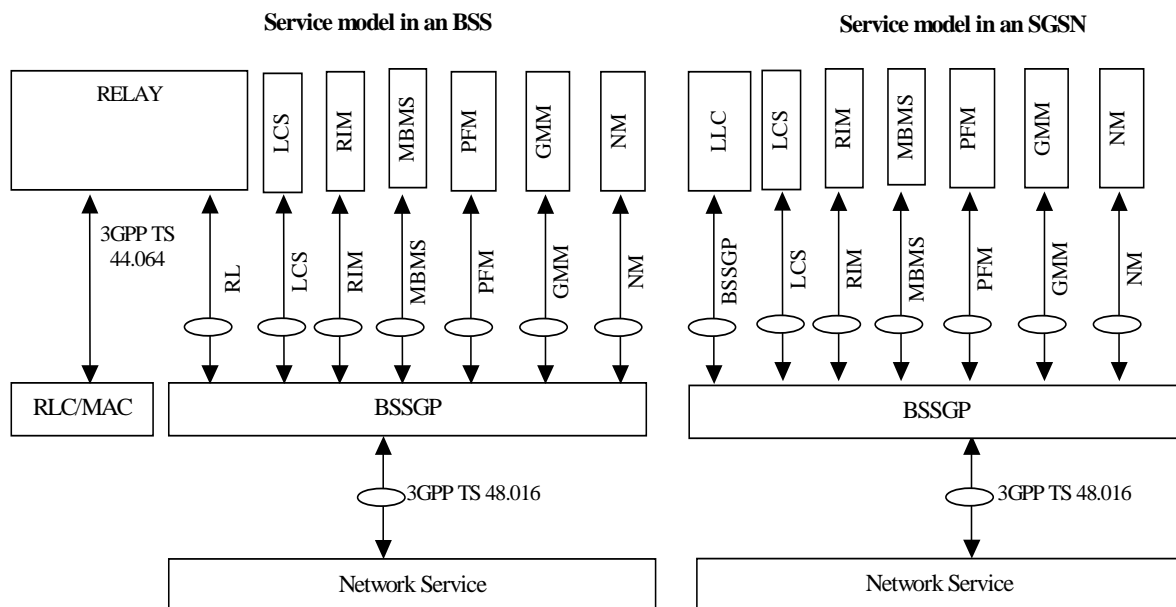

**Figure 5.1: BSSGP service model**

Primitives consist of commands and their respective responses associated with the services requested of another layer. The general syntax of a primitive is:

- XX - Generic name - Type (Parameters);

where XX designates the layer providing or using the service.

In the present document, XX is:

- "BSSGP" for functions controlling the transfer of LLC frames passed between an SGSN and an MS across the Gb interface;
- "RL" (relay) for functions controlling the transfer of LLC frames between the RLC/MAC function and BSSGP;
- "GMM" (GPRS mobility management) for functions associated with mobility management between an SGSN and a BSS; and

- "NM" (network management) for functions associated with Gb-interface and BSS-SGSN node management;
- "PFM" (packet flow management) for functions associated with the management of BSS Packet Flow Contexts (PFCs);
- "LCS" (location services) for functions associated with location services (LCS) procedures;
- "RIM" (RAN Information Management) for functions associated with generic procedures to communicate between two BSSs over the core network.
- "MBMS" (Multimedia Broadcast Multicast Service) for functions associated with Multimedia Broadcast Multicast Service (MBMS) procedures.

## 5.2 Service primitives provided by the BSSGP at a BSS

Table 5.2: Service primitives provided by BSSGP at a BSS

Generic name	Type				Parameters
	REQuest	INDication	RESponse	CoNFirm	
<b>RL ⇄ BSSGP</b>					
RL-DL-UNITDATA	-	X	-	-	BVCI, NSEI, Refer to DL-UNITDATA PDU
RL-UL-UNITDATA	X	-	-	-	BVCI, NSEI, LSP, Refer to UL- UNITDATA PDU
RL-DL-MBMS-UNITDATA	-	X	-	-	BVCI, NSEI, Refer to DL-MBMS-UNITDATA PDU
RL-UL-MBMS-UNITDATA	X	-	-	-	BVCI, NSEI, LSP, Refer to UL-MBMS-UNITDATA PDU
<b>GMM ⇄ BSSGP</b>					
GMM-PAGING	-	X	-	-	BVCI, NSEI, Refer to PAGING PS PDU Refer to PDU PAGING CS PDU
GMM-RA-CAPABILITY	-	X	-	-	BVCI, NSEI, Refer to RA-CAPABILITY PDU
GMM-RA-CAPABILITY-UPDATE	X	-	-	X	BVCI, NSEI, Refer to RA-CAPABILITY-UPDATE PDU, Refer to RA-CAPABILITY-UPDATE-ACK PDU
GMM-RADIO-STATUS	X	-	-	-	BVCI, NSEI, Refer to RADIO-STATUS PDU
GMM-SUSPEND	X	-	-	X	BVCI, NSEI, Refer to SUSPEND PDU Refer to SUSPEND-(N)ACK PDU
GMM-RESUME	X	-	-	X	BVCI, NSEI, Refer to RESUME PDU Refer to RESUME-(N)ACK PDU
GMM-MS-REGISTRATION-ENQUIRY	X	-	X	-	BVCI, NSEI, Refer to MS-REGISTRATION-ENQUIRY PDU Refer to MS-REGISTRATION-ENQUIRY-RESPONSE PDU
<b>NM ⇄ BSSGP</b>					
NM-FLUSH-LL	-	X	X	-	BVCI, NSEI, Refer to FLUSH-LL PDU Refer to FLUSH-LL-ACK PDU
NM-LLC-DISCARDED	X	-	-	-	BVCI, NSEI, Refer to LLC-DISCARDED PDU
NM-FLOW-CONTROL-BVC	X	-	-	X	BVCI, NSEI, Refer to FLOW-CONTROL-BVC PDU Refer to FLOW-CONTROL-BVC ACK PDU

Generic name	Type				Parameters
	REQuest	INDication	RESponse	CoNFirm	
NM-FLOW-CONTROL-MS	X	-	-	X	BVCI, NSEI, Refer to FLOW-CONTROL-MS PDU Refer to FLOW-CONTROL-MS ACK PDU
NM-FLOW-CONTROL-PFC	X	-	-	X	BVCI, NSEI, Refer to FLOW-CONTROL-PFC PDU Refer to FLOW-CONTROL-PFC ACK PDU
NM-STATUS	X	X	-	-	BVCI, NSEI, Refer to STATUS PDU
NM-BVC-BLOCK	X	-	-	X	BVCI, NSEI, Refer to BVC-BLOCK PDU Refer to BVC-BLOCK-ACK PDU
NM-BVC-UNBLOCK	X	-	-	X	BVCI, NSEI, Refer to BVC-UNBLOCK PDU Refer to BVC-UNBLOCK-ACK PDU
NM-BVC-RESET	X	X	X	X	BVCI, NSEI, Refer to BVC-RESET PDU Refer to BVC-RESET-ACK PDU
NM-TRACE	-	X	-	-	BVCI, NSEI, Refer to SGSN-INVOKE-TRACE PDU
NW-OVERLOAD	-	X	-	-	BVCI, NSEI, Refer to OVERLOAD PDU
<b>PFM ↔ BSSGP</b>					
PFM-DOWNLOAD-BSS-PFC	X	-	-	-	BVCI, NSEI Refer to DOWNLOAD-BSS-PFC PDU
PFM-CREATE-BSS-PFC	-	X	X	-	BVCI, NSEI Refer to CREATE-BSS-PFC PDU Refer to CREATE-BSS-PFC-ACK PDU Refer to CREATE-BSS-PFC-NACK PDU
PFM-MODIFY-BSS-PFC	X	-	-	X	BVCI, NSEI Refer to MODIFY-BSS-PFC PDU Refer to MODIFY-BSS-PFC-ACK PDU
PFM-DELETE-BSS-PFC	X	X	X	-	BVCI, NSEI Refer to DELETE-BSS-PFC PDU Refer to DELETE-BSS-PFC-ACK PDU Refer to DELETE-BSS-PFC-REQ PDU
PFM-PS-HANDOVER-REQUIRED	X	-	-	X	BVCI, NSEI, Refer to PS-HANDOVER-REQUIRED PDU Refer to PS-HANDOVER-REQUIRED-(N)ACK PDU
PFM-PS-HANDOVER-REQUEST	-	X	X	-	BVCI, NSEI, Refer to PS-HANDOVER-REQUEST PDU Refer to PS-HANDOVER-REQUEST-(N)ACK PDU

Generic name	Type				Parameters
	REQuest	INDication	RESponse	CoNFirm	
PFM-PS-HANDOVER-COMplete	X	-	-	-	BVCI, NSEI, Refer to PS-HANDOVER-COMplete PDU
PFM-PS-HANDOVER-CANCEL	X	-	-	-	BVCI, NSEI, Refer to PS-HANDOVER-CANCEL PDU
<b>LCS ↔ BSSGP</b>					
LCS-LOCATE	-	X	X	-	BVCI, NSEI Refer to PERFORM-LOCATION-REQUEST PDU Refer to PERFORM-LOCATION-RESPONSE PDU
LCS-ABORT	-	X	-	-	BVCI, NSEI Refer to PERFORM-LOCATION-ABORT PDU
LCS-INFORMATION-TRANSFER	X	-	-	X	BVCI, NSEI Refer to POSITION-COMMAND PDU Refer to POSITION-RESPONSE PDU
<b>RIM ↔ BSSGP</b>					
RIM-PDU-TRANSFER	X	X	-	-	BVCI, NSEI Refer to RAN-INFORMATION-REQUEST, RAN-INFORMATION, RAN-INFORMATION-ACK, RAN-INFORMATION-APPLICATION-ERROR, RAN-INFORMATION-ERROR PDUs;
<b>MBMS ↔ BSSGP</b>					
MBMS-SESSION-START	-	X	X	-	BVCI, NSEI Refer to MBMS-SESSION-START-REQUEST PDU; Refer to MBMS-SESSION-START-RESPONSE PDU
MBMS-SESSION-STOP	-	X	X	-	BVCI, NSEI Refer to MBMS-SESSION-STOP-REQUEST PDU; Refer to MBMS-SESSION-STOP-RESPONSE PDU
MBMS-SESSION-UPDATE	-	X	X	-	BVCI, NSEI Refer to MBMS-SESSION-UPDATE-REQUEST PDU; Refer to MBMS-SESSION-UPDATE-RESPONSE PDU

### 5.2.1 RL-DL-UNITDATA.ind

Receipt of a DL-UNITDATA PDU from an SGSN by a BSS containing an LLC-PDU and MS control information necessary for the transmission of the LLC-PDU across the radio interface.

### 5.2.2 RL-UL-UNITDATA.req

Request to send a UL-UNITDATA PDU to an SGSN from a BSS containing an LLC-PDU and radio interface derived information.



### 5.2.3 (void)

#### 5.2.3a RL-DL-MBMS-UNITDATA.ind

Receipt of a DL-MBMS-UNITDATA PDU from an SGSN by a BSS containing an LLC-PDU for the transmission of the LLC-PDU across the radio interface.

#### 5.2.3b RL-UL-MBMS-UNITDATA.req

Request to send a UL-MBMS-UNITDATA PDU to an SGSN from a BSS containing an LLC-PDU.

### 5.2.4 GMM-PAGING.ind

Receipt of a PAGING-PS or PAGING-CS PDU from an SGSN by a BSS containing instructions to page an MS within a given group of cells.

### 5.2.5 GMM-RA-CAPABILITY.ind

Receipt of a RA-CAPABILITY PDU from an SGSN by a BSS providing the new Radio Access capability of an MS.

### 5.2.6 GMM-RA-CAPABILITY-UPDATE.req

Request to send a RA-CAPABILITY-UPDATE PDU to an SGSN from a BSS in order to receive the current Radio Access capabilities of an MS.

### 5.2.7 GMM-RA-CAPABILITY-UPDATE.cnf

Receipt of a RA-CAPABILITY-UPDATE-ACK PDU from a SGSN by a BSS containing the current Radio Access capabilities of an MS.

### 5.2.8 GMM-RADIO-STATUS.req

Request to send a RADIO-STATUS PDU to an SGSN from a BSS to report that an exception condition occurred in the operation of the radio interface for an MS.

### 5.2.9 GMM-SUSPEND.req

Request to send a SUSPEND PDU to an SGSN from a BSS to mark an MS's GPRS service as suspended.

### 5.2.10 GMM-SUSPEND.cnf

Receipt of a SUSPEND-ACK PDU from an SGSN by a BSS confirming that an SGSN has marked an MS's GPRS service as suspended.

### 5.2.11 GMM-RESUME.req

Request to send a RESUME PDU to an SGSN from a BSS to mark an MS's GPRS service as resumed.

### 5.2.12 GMM-RESUME.cnf

Receipt of a RESUME-ACK PDU from an SGSN by a BSS confirming that an SGSN has marked an MS's GPRS service as resumed.

### 5.2.12a GMM-MS-REGISTRATION-ENQUIRY.req

Request to send a MS-REGISTRATION-ENQUIRY PDU to an SGSN from a BSS enquiring registration information for a given MS.

### 5.2.12b GMM-MS-REGISTRATION-ENQUIRY.res

Receipt of a MS-REGISTRATION-ENQUIRY-RESPONSE PDU from an SGSN by a BSS, containing registration information for a given MS.

### 5.2.13 NM-FLUSH-LL.ind

On receipt of a FLUSH-LL PDU by a BSS from an SGSN, the BSS will either delete queued LLC-PDUs for a TLLI or move the queued LLC-PDUs from an old to a new BVC. If there is a BSS context for the Mobile Station identified by the TLLI and the BSS is able to move the queued LLC-PDUs, the BSS has to move the BSS context from the old to the new BVC, even if it is not able to offer the same QoS characteristics in the new BVC.

### 5.2.14 NM-FLUSH-LL.res

Sending of a FLUSH-LL-ACK PDU to the SGSN from a BSS to report if queued LLC-PDU(s) for an MS were deleted or transferred from the old to the new cell within the routing area. The FLUSH-LL-ACK PDU may also report whether the QoS characteristics of the BSS context associated to the MS could be kept in the new cell.

### 5.2.15 NM-LLC-DISCARDED.req

Request to send a LLC-DISCARDED PDU to an SGSN from a BSS indicating that LLC frames pertaining to an MS have been locally discarded.

### 5.2.16 NM-FLOW-CONTROL-BVC.req

Request to send a FLOW-CONTROL-BVC PDU to an SGSN from a BSS indicating the ability of a BVC to accept a certain flow of data.

### 5.2.17 NM-FLOW-CONTROL-BVC.cnf

Confirmation that a FLOW-CONTROL-BVC PDU has been received by an SGSN for a given BVC.

### 5.2.18 NM-FLOW-CONTROL-MS.req

Request to send a FLOW-CONTROL-MS PDU to an SGSN from a BSS indicating the ability to accept a certain flow of data for a given MS.

### 5.2.19 NM-FLOW-CONTROL-MS.cnf

Confirmation that a FLOW-CONTROL-MS PDU has been received by an SGSN for a given MS.

### 5.2.19a NM-FLOW-CONTROL-PFC.req

Request to send a FLOW-CONTROL-PFC PDU to an SGSN from a BSS indicating the ability to accept a certain flow of data for a given PFC of a given MS.

### 5.2.19b NM-FLOW-CONTROL-PFC.cnf

Confirmation that a FLOW-CONTROL-PFC PDU has been received by an SGSN for a given PFC of a given MS.

### 5.2.20 NM-STATUS.req

Request to send a STATUS PDU to an SGSN from a BSS to report that an exception condition occurred within the BSS.

### 5.2.21 NM-STATUS.ind

Receipt of a STATUS PDU from an SGSN by a BSS indicating that an exception condition occurred within an SGSN.

### 5.2.22 NM-BVC-BLOCK.req

Request to send a BVC-BLOCK PDU to an SGSN from a BSS to mark a BVC as blocked.

### 5.2.23 NM-BVC-BLOCK.cnf

Receipt of a BVC-BLOCK-ACK PDU from an SGSN by a BSS confirming that an SGSN has marked a BVC as blocked.

### 5.2.24 NM-BVC-UNBLOCK.req

Request to send a BVC-UNBLOCK PDU to an SGSN from a BSS to mark a BVC as unblocked.

### 5.2.25 NM-BVC-UNBLOCK.cnf

Receipt of a BVC-UNBLOCK-ACK PDU from an SGSN by a BSS confirming that an SGSN has marked a BVC as unblocked.

### 5.2.26 NM-BVC-RESET.req

Request to send a BVC-RESET PDU to an SGSN from a BSS to reset an SGSN's GPRS BVC contexts.

### 5.2.27 NM-BVC-RESET.res

Sending of a BVC-RESET-ACK PDU to the SGSN from an BSS indicating that a GPRS BVC context has been reset in the BSS.

### 5.2.28 NM-BVC-RESET.ind

Receipt of a BVC-RESET PDU at a BSS from an SGSN indicating that GPRS BVC contexts have been reset at the SGSN.

### 5.2.29 NM-BVC-RESET.cnf

Receipt of a BVC-RESET-ACK PDU at a BSS confirming that GPRS BVC context has been reset at the SGSN.

### 5.2.30 NM-TRACE.ind

Receipt of a SGSN-INVOKE-TRACE PDU at a BSS from an SGSN indicating the need to produce a trace record on an MS.

### 5.2.30a NW-OVERLOAD.ind

Receipt of an OVERLOAD PDU from an SGSN by a BSS informing the BSS the SGSN is in an overload state.

### 5.2.31 PFM-DOWNLOAD-BSS-PFC.req

Upon a request to transfer an uplink or downlink LLC PDU for which it currently does not have a BSS Packet Flow Context, the BSS may send a DOWNLOAD-BSS-PFC PDU to an SGSN.

### 5.2.32 PFM-CREATE-BSS-PFC.ind

Receipt of a CREATE-BSS-PFC PDU at a BSS from an SGSN indicating that the BSS should create or modify a BSS Packet Flow Context using the Aggregate BSS QoS Profile.

### 5.2.33 PFM-CREATE-BSS-PFC.res

Sending of a CREATE-BSS-PFC-ACK PDU to the SGSN from a BSS to respond with an Aggregate BSS QoS Profile, indicating queuing or successful creation of the PFC, or a CREATE-BSS-PFC-NACK in case the BSS was unable to create the PFC.

### 5.2.34 PFM-MODIFY-BSS-PFC.req

Request to send a MODIFY-BSS-PFC PDU to an SGSN from a BSS to modify an Aggregate BSS QoS Profile.

### 5.2.35 (void)

### 5.2.36 (void)

### 5.2.37 PFM-MODIFY-BSS-PFC.cnf

Reception of a MODIFY-BSS-PFC-ACK PDU at a BSS from an SGSN confirming the modification of an Aggregate BSS QoS Profile.

### 5.2.38 PFM-DELETE-BSS-PFC.ind

Receipt of a DELETE-BSS-PFC PDU at a BSS from an SGSN to delete an Aggregate BSS QoS Profile.

### 5.2.39 PFM-DELETE-BSS-PFC.res

Sending of a DELETE-BSS-PFC-ACK PDU to an SGSN from a BSS to respond to a deletion.

### 5.2.39a PFM-DELETE-BSS-PFC.req

Sending of a DELETE-BSS-PFC-REQ PDU to an SGSN from a BSS to request to a deletion of an Aggregate BSS QoS Profile.

### 5.2.39b PFM-PS-HANDOVER-REQUIRED.req

Request to send a PS-HANDOVER-REQUIRED PDU to the SGSN from the source BSS to initiate the allocation of resources in the target system at PS handover.

### 5.2.39c PFM-PS-HANDOVER-REQUIRED.cnf

Receipt of a PS-HANDOVER-REQUIRED-ACK PDU from the SGSN by the source BSS reporting successful allocation of resources in the target system at PS handover.

### 5.2.39d PFM-PS-HANDOVER-REQUEST.ind

Receipt of a PS-HANDOVER-REQUEST PDU from the SGSN by the target BSS to initiate the allocation of resources for one or more PFCs during PS handover.

### 5.2.39e PFM-PS-HANDOVER-REQUEST.res

Request to send a PS-HANDOVER-REQUEST-ACK PDU to the SGSN from the target BSS to report the successful allocation of resources during PS handover.

### 5.2.39f PFM-PS-HANDOVER-COMPLETE.req

Request to send a PS-HANDOVER-COMPLETE PDU to the SGSN from the target BSS to report a successful channel change during PS handover.

### 5.2.39g PFM-PS-HANDOVER-CANCEL.req

Request to send a PS-HANDOVER-CANCEL PDU to the SGSN from the source BSS to cancel a previously initiated PS handover.

### 5.2.40 LCS-LOCATE.ind

Receipt of a PERFORM-LOCATION-REQUEST PDU at a BSS from an SGSN requesting a location procedure for a target MS.

### 5.2.41 LCS-LOCATE.res

Sending of a PERFORM-LOCATION-RESPONSE PDU to an SGSN responding to the location request for a target MS.

### 5.2.42 LCS-ABORT.ind

Receipt of a PERFORM-LOCATION-ABORT PDU at a BSS from an SGSN indicating a request of an abort of a location procedure for a target MS.

### 5.2.43 LCS-INFORMATION-TRANSFER.req

Request to send a POSITION-COMMAND PDU to an SGSN from a BSS that has LCS related information associated with a higher level protocol available to transfer.

### 5.2.44 LCS-INFORMATION-TRANSFER.cnf

Confirmation in a POSITION-RESPONSE PDU that the higher layer message has been received and an indication of the result of the message transfer and possibly including a reply with another higher layer protocol message.

### 5.2.45 RIM-PDU-TRANSFER.req

Sending of a RAN-INFORMATION-REQUEST, RAN-INFORMATION, RAN-INFORMATION-ACK, RAN-INFORMATION-APPLICATION-ERROR, RAN-INFORMATION-ERROR PDU to an SGSN from a BSS for routing of the PDU to another BSS.

### 5.2.46 RIM-PDU-TRANSFER.ind

Reception of a RAN-INFORMATION-REQUEST, RAN-INFORMATION, RAN-INFORMATION-ACK, RAN-INFORMATION-APPLICATION-ERROR, RAN-INFORMATION-ERROR PDU at a BSS from an SGSN originating from another BSS.

5.2.47 (void)

5.2.48 (void)

5.2.49 (void)

5.2.50 (void)

5.2.51 (void)

5.2.52 (void)

### 5.2.53 MBMS-SESSION-START-REQUEST.ind

Reception of an MBMS-SESSION-START-REQUEST PDU at a BSS from an SGSN requesting to start an MBMS session.

### 5.2.54 MBMS-SESSION-START-RESPONSE.res

Sending of an MBMS-SESSION-START-RESPONSE PDU to an SGSN from a BSS acknowledging to start an MBMS session.

### 5.2.55 MBMS-SESSION-STOP-REQUEST.ind

Reception of an MBMS-SESSION-STOP-REQUEST PDU at a BSS from an SGSN requesting to stop an MBMS session.

### 5.2.56 MBMS-SESSION-STOP-RESPONSE.res

Sending of an MBMS-SESSION-STOP-RESPONSE PDU to an SGSN from a BSS acknowledging to stop an MBMS session.

### 5.2.57 MBMS-SESSION-UPDATE-REQUEST.ind

Reception of an MBMS-SESSION-UPDATE-REQUEST PDU at a BSS from an SGSN requesting to update the MBMS service area list of an ongoing MBMS broadcast service session.

### 5.2.58 MBMS-SESSION-UPDATE-RESPONSE.res

Sending of an MBMS-SESSION-UPDATE-RESPONSE PDU to an SGSN from a BSS acknowledging to update the MBMS service area list of an ongoing MBMS broadcast service session.

## 5.3 Service primitives provided by the BSSGP at an SGSN

**Table 5.3: Service primitives provided by BSSGP at an SGSN**

Generic name	Type				Parameters
	REQuest	INDication	RESponse	CoNFirm	

Generic name	Type				Parameters
	REquest	INDication	RESponse	CoNFirm	
<b>LL ⇔ BSSGP</b>					
BSSGP-DL-UNITDATA	X	-	-	-	BVCI, NSEI, LSP, Refer to DL-UNITDATA PDU
BSSGP-UL-UNITDATA	-	X			BVCI, NSEI, Refer to UL-UNITDATA PDU
BSSGP-DL-MBMS-UNITDATA	X	-	-	-	BVCI, NSEI, Refer to DL-MBMS-UNITDATA PDU
BSSGP-UL-MBMS-UNITDATA	-	X	-	-	BVCI, NSEI, Refer to UL-MBMS-UNITDATA PDU
<b>GMM ⇔ BSSGP</b>					
GMM-PAGING	X	-	-	-	BVCI, NSEI, Refer to PAGING PS PDU Refer to PAGING CS PDU
GMM-RA-CAPABILITY	X				BVCI, NSEI, Refer to RA-CAPABILITY PDU
GMM-RA-CAPABILITY-UPDATE	-	X	X	-	BVCI, NSEI, Refer to RA-CAPABILITY-UPDATE PDU, Refer to RA-CAPABILITY-UPDATE-ACK PDU
GMM-RADIO-STATUS	-	X	-	-	BVCI, NSEI, Refer to RADIO-STATUS PDU
GMM-SUSPEND	-	X	-	-	BVCI, NSEI, Refer to SUSPEND PDU Refer to SUSPEND-(N)ACK PDU
GMM-RESUME	-	X	-	-	BVCI, NSEI, Refer to RESUME PDU Refer to RESUME-(N)ACK PDU
GMM-MS-REGISTRATION-ENQUIRY	-	X	X	-	BVCI, NSEI, Refer to MS-REGISTRATION-ENQUIRY PDU Refer to MS-REGISTRATION-ENQUIRY-RESPONSE PDU
<b>NM ⇔ BSSGP</b>					
NM-FLUSH-LL	X	-	-	X	BVCI, NSEI, Refer to FLUSH-LL PDU Refer to FLUSH-LL-ACK PDU
NM-LLC-DISCARDED	-	X	-	-	BVCI, NSEI, Refer to LLC-DISCARDED PDU
NM-FLOW-CONTROL-BVC	-	X	-	-	BVCI, NSEI, Refer to FLOW-CONTROL-BVC PDU Refer to FLOW-CONTROL-BVC ACK PDU
NM-FLOW-CONTROL-MS	-	X	-	-	BVCI, NSEI, Refer to FLOW-CONTROL-MS PDU Refer to FLOW-CONTROL-MS ACK PDU
NM-FLOW-CONTROL-PFC	-	X	-	-	BVCI, NSEI, Refer to FLOW-CONTROL-PFC PDU Refer to FLOW-CONTROL-PFC ACK PDU

Generic name	Type				Parameters
	REQuest	INDication	RESponse	CoNFirm	
NM-STATUS	X	X	-	-	BVCI, NSEI, Refer to STATUS PDU
NM-BVC-BLOCK	-	X	-	-	BVCI, NSEI, Refer to BVC-BLOCK PDU Refer to BVC-BLOCK-ACK PDU
NM-BVC-UNBLOCK	-	X	-	-	BVCI, NSEI, Refer to BVC-UNBLOCK PDU Refer to BVC-UNBLOCK-ACK PDU
NM-BVC-RESET	X	X	X	X	BVCI, NSEI, Refer to BVC-RESET PDU Refer to BVC-RESET-ACK PDU
NM-TRACE	X	-	-	-	BVCI, NSEI, Refer to SGSN-INVOKE-TRACE PDU
NW-OVERLOAD	X	-	-	-	BVCI, NSEI, Refer to OVERLOAD PDU
<b>PFM ⇔ BSSGP</b>					
PFM-DOWNLOAD-BSS-PFC	-	X	-	-	BVCI, NSEI Refer to DOWNLOAD-BSS-PFC PDU
PFM-CREATE-BSS-PFC	X	-	-	X	BVCI, NSEI Refer to CREATE-BSS-PFC PDU Refer to CREATE-BSS-PFC-ACK PDU Refer to CREATE-BSS-PFC-NACK PDU
PFM-MODIFY-BSS-PFC		X	X		BVCI, NSEI Refer to MODIFY-BSS-PFC PDU Refer to MODIFY-BSS-PFC-ACK PDU
PFM-DELETE-BSS-PFC	X	X	-	X	BVCI, NSEI Refer to DELETE-BSS-PFC PDU Refer to DELETE-BSS-PFC-ACK PDU Refer to to DELETE-BSS-PFC-REQ PDU
PFM-PS-HANDOVER-REQUIRED	-	X	X	-	BVCI, NSEI, Refer to PS-HANDOVER-REQUIRED PDU Refer to PS-HANDOVER-REQUIRED-(N)ACK PDU
PFM-PS-HANDOVER-REQUEST	X	-	-	X	BVCI, NSEI, Refer to PS-HANDOVER-REQUEST PDU Refer to PS-HANDOVER-REQUEST-(N)ACK PDU
PFM-PS-HANDOVER-COMPLETE	-	X	-	-	BVCI, NSEI, Refer to PS-HANDOVER-COMPLETE PDU
PFM-PS-HANDOVER-CANCEL	-	X	-	-	BVCI, NSEI, Refer to PS-HANDOVER-CANCEL PDU
<b>LCS ⇔ BSSGP</b>					



Generic name	Type				Parameters
	REQuest	INDication	RESponse	CoNFirm	
LCS-LOCATE	X	-	-	X	BVCI, NSEI Refer to PERFORM-LOCATION-REQUEST PDU Refer to PERFORM-LOCATION-RESPONSE PDU
LCS-ABORT	X	-	-	-	BVCI, NSEI Refer to PERFORM-LOCATION-ABORT PDU
LCS-INFORMATION-TRANSFER	-	X	X	-	BVCI, NSEI Refer to POSITION-COMMAND PDU Refer to POSITION-RESPONSE PDU
<b>RIM ↔ BSSGP</b>					
RIM-PDU-TRANSFER	X	X	-	-	BVCI, NSEI Refer to RAN-INFORMATION-REQUEST, RAN-INFORMATION, RAN-INFORMATION-ACK, RAN-INFORMATION-APPLICATION-ERROR, RAN-INFORMATION-ERROR PDUs;
<b>MBMS ↔ BSSGP</b>					
MBMS-SESSION-START	X	-	-	X	BVCI, NSEI Refer to MBMS-SESSION-START-REQUEST PDU; Refer to MBMS-SESSION-START-RESPONSE PDU
MBMS-SESSION-STOP	X	-	-	X	BVCI, NSEI Refer to MBMS-SESSION-STOP-REQUEST PDU; Refer to MBMS-SESSION-STOP-RESPONSE PDU
MBMS-SESSION-UPDATE	X	-	-	X	BVCI, NSEI Refer to MBMS-SESSION-UPDATE-REQUEST PDU; Refer to MBMS-SESSION-UPDATE-RESPONSE PDU

NOTE: The parameters in the BSSGP-DL-UNITDATA and BSSGP-UL-UNITDATA primitives that are not included in the corresponding primitives in 3GPP TS 44.064 are provided or extracted by some intermediate function out of the scope of the present document.

### 5.3.1 BSSGP-DL-UNITDATA.req

Request to send a DL-UNITDATA PDU to a BSS from an SGSN containing an LLC-PDU and control information necessary for the transmission of the LLC-PDU across the radio interface.

### 5.3.2 BSSGP-UL-UNITDATA.ind

Receipt of a UL-UNITDATA PDU from a BSS by an SGSN containing an LLC-PDU and radio interface derived information.

### 5.3.3 (void)

### 5.3.3a BSSGP-DL-MBMS-UNITDATA.req

Request to send a DL-MBMS-UNITDATA PDU to a BSS from an SGSN containing an LLC-PDU for the transmission of the LLC-PDU across the radio interface.

### 5.3.3b BSSGP-UL-MBMS-UNITDATA.ind

Receipt of a UL-MBMS-UNITDATA PDU from a BSS by an SGSN containing an LLC-PDU.

### 5.3.4 GMM-PAGING.req

Request to send a PAGING-PS or PAGING-CS PDU from an SGSN to a BSS containing instructions to page an MS within a given group of cells.

### 5.3.5 GMM-RA-CAPABILITY.req

Request to send a RA-CAPABILITY PDU to the BSS from an SGSN containing the Radio Access capability of an MS.

### 5.3.6 GMM-RA-CAPABILITY-UPDATE.ind

Receipt of a RA-CAPABILITY-UPDATE PDU from a BSS by an SGSN, requesting that the SGSN sends the Radio Access capability of an MS to the BSS.

### 5.3.7 GMM-RA-CAPABILITY-UPDATE.res

Sending of a RA-CAPABILITY-UPDATE-ACK PDU to the BSS from an SGSN containing the current Radio Access capability of an MS.

### 5.3.8 GMM-RADIO-STATUS.ind

Receipt of a RADIO-STATUS PDU from a BSS by an SGSN to report that an exception condition occurred in the operation of the radio interface for an MS.

### 5.3.9 GMM-SUSPEND.ind

Receipt of a SUSPEND PDU from a BSS by an SGSN indicating that an MS wishes to suspended its GPRS service.

### 5.3.10 GMM-RESUME.ind

Receipt of a RESUME PDU from a BSS by an SGSN indicating that an MS wishes to resume its GPRS service.

### 5.3.10a GMM-MS-REGISTRATION-ENQUIRY.ind

Receipt of a MS-REGISTRATION-ENQUIRY PDU from a BSS by an SGSN enquiring registration information for a given MS.

### 5.3.10b GMM-MS-REGISTRATION-ENQUIRY.res

Request to send a MS-REGISTRATION-ENQUIRY-RESPONSE PDU to a BSS from an SGSN containing registration information for a given MS.

### 5.3.11 NM-FLUSH-LL.req

Request to send a FLUSH-LL PDU from an SGSN to a BSS, instructing the BSS to either delete queued LLC-PDUs for a TLLI or move the queued LLC-PDUs from an old to a new BVC.

### 5.3.12 NM-FLUSH-LL.cnf

Receipt of a FLUSH-LL-ACK PDU at an SGSN informing if the queued LLC-PDU(s) for an MS were deleted or transferred from the old to the new cell within the routing area. The FLUSH-LL-ACK PDU may also report whether the QoS characteristics of the BSS context associated to the MS could be kept in the new cell.

### 5.3.13 NM-LLC-DISCARDED.ind

Receipt of a LLC-DISCARDED PDU from a BSS by an SGSN indicating that LLC frames pertaining to an MS have been locally discarded.

### 5.3.14 NM-FLOW-CONTROL-BVC.ind

Receipt of a FLOW-CONTROL-BVC PDU from a BSS by an SGSN indicating the ability of a BVC to accept a certain flow of data.

### 5.3.15 NM-FLOW-CONTROL-MS.ind

Receipt of a FLOW-CONTROL-MS PDU from a BSS by an SGSN indicating the ability to accept a certain flow of data for a given MS.

### 5.3.15a NM-FLOW-CONTROL-PFC.ind

Receipt of a FLOW-CONTROL-PFC PDU from a BSS by an SGSN indicating the ability to accept a certain flow of data for a given PFC of a given MS.

### 5.3.16 NM-STATUS.req

Request to send a STATUS PDU to a BSS from an SGSN to report that an exception condition occurred within an SGSN.

### 5.3.17 NM-STATUS.ind

Receipt of a STATUS PDU from a BSS by an SGSN indicating an exception condition occurred within the BSS.

### 5.3.18 NM-BVC-BLOCK.ind

Receipt of a BVC-BLOCK PDU from a BSS by an SGSN indicating that a BVC shall be marked as blocked.

### 5.3.19 NM-BVC-UNBLOCK.ind

Receipt of a BVC-UNBLOCK PDU from a BSS by an SGSN indicating that a BVC shall be marked as unblocked.

### 5.3.20 NM-BVC-RESET.req

Request to send a BVC-RESET PDU to a BSS from an SGSN to reset a BSS's GPRS BVC contexts.

### 5.3.21 NM-BVC-RESET.res

Sending of a BVC-RESET-ACK PDU to the BSS from a SGSN indicating that a GPRS BVC context has been reset in the SGSN.

### 5.3.22 NM-BVC-RESET.ind

Receipt of a BVC-RESET PDU at an SGSN from a BSS indicating that GPRS BVC contexts have been reset at the BSS.

### 5.3.23 NM-BVC-RESET.cnf

Receipt of a BVC-RESET-ACK PDU at an SGSN confirming that GPRS BVC contexts have been reset at the BSS.

### 5.3.24 NM-TRACE.req

Request to send an SGSN-INVOKE-TRACE PDU to a BSS from an SGSN to begin producing a trace record on an MS.

### 5.3.24a NM-OVERLOAD-START.req

Request to send an OVERLOAD PDU to a BSS from an SGSN to inform the BSS an overload situation happened in the SGSN.

### 5.3.25 PFM-DOWNLOAD-BSS-PFC.ind

Receipt of a DOWNLOAD-BSS-PFC PDU at an SGSN from a BSS.

### 5.3.26 PFM-CREATE-BSS-PFC.req

Sending of a CREATE-BSS-PFC PDU to a BSS from an SGSN requesting that the BSS should create or modify a BSS Packet Flow Context using the Aggregate BSS QoS Profile.

### 5.3.27 PFM-CREATE-BSS-PFC.cnf

Receipt of a CREATE-BSS-PFC-ACK PDU at an SGSN from a BSS confirming the creation or modification or queuing of a BSS Packet Flow Context using the Aggregate BSS QoS Profile or a CREATE-BSS-PFC-NACK in to indicate the BSS was unable to create the PFC.

### 5.3.28 PFM-MODIFY-BSS-PFC.ind

Receipt of a MODIFY-BSS-PFC PDU at an SGSN from a BSS to modify an Aggregate BSS QoS Profile.

### 5.3.29 PFM-MODIFY-BSS-PFC.res

Sending of a MODIFY-BSS-PFC-ACK PDU to a BSS from an SGSN to respond with an Aggregate BSS QoS Profile.

### 5.3.30 PFM-DELETE-BSS-PFC.req

Sending of a DELETE-BSS-PFC PDU to a BSS from an SGSN to delete an Aggregate BSS QoS Profile.

### 5.3.31 PFM-DELETE-BSS-PFC.cnf

Receipt of a DELETE-BSS-PFC-ACK PDU at an SGSN from a BSS to confirm the deletion of an Aggregate BSS QoS Profile.

### 5.3.31a PFM-DELETE-BSS-PFC.ind

Receipt of a DELETE-BSS-PFC-REQ PDU at an SGSN from a BSS that a deletion of an Aggregate BSS QoS Profile is requested.

### 5.3.31b PFM-PS-HANDOVER-REQUIRED.ind

Receipt of a PS-HANDOVER-REQUIRED PDU from the source BSS by the SGSN indicating initiation of a PS handover.

### 5.3.31c PFM-PS-HANDOVER-REQUIRED.res

Request to send a PS-HANDOVER-REQUIRED-ACK PDU from the SGSN to the source BSS to initiate the channel change attempt during PS handover.

### 5.3.31d PFM-PS-HANDOVER-REQUEST.req

Request to send a PS-HANDOVER-REQUEST PDU from the SGSN to the target BSS to initiate the allocation of resources for one or more PFCs during PS handover.

### 5.3.31e PFM-PS-HANDOVER-REQUEST.cnf

Receipt of a PS-HANDOVER-REQUEST-ACK PDU from the target BSS by the SGSN reporting the successful allocation of resources during PS handover.

### 5.3.31f PFM-PS-HANDOVER-COMPLETE.ind

Receipt of a PS-HANDOVER-COMPLETE PDU from the target BSS by the SGSN reporting a successful channel change during PS handover.

### 5.3.31g PFM-PS-HANDOVER-CANCEL.ind

Receipt of a PS-HANDOVER-CANCEL PDU from the source BSS by the SGSN indicating cancellation of a previously initiated PS handover.

### 5.3.32 LCS-LOCATE.req

Sending of a PERFORM-LOCATION-REQUEST PDU at an SGSN requesting a location procedure for a target MS.

### 5.3.33 LCS-LOCATE.cnf

Receipt of a PERFORM-LOCATION-RESPONSE PDU confirming that the location request for a target MS has been attempted indicating the result of this attempt.

### 5.3.34 LCS-ABORT.req

Sending of a PERFORM-LOCATION-ABORT PDU from an SGSN to a BSS requesting an abort of a location procedure for a target MS.

### 5.3.35 LCS-INFORMATION-TRANSFER.ind

Receipt of a POSITION-COMMAND PDU at an SGSN from a BSS requesting a transfer of a higher level protocol message.

### 5.3.36 LCS-INFORMATION-TRANSFER.res

Sending of a POSITION-RESPONSE PDU from an SGSN to a BSS indicating the result of the message transfer and possibly including the transfer of a new higher layer protocol message.

### 5.3.37 RIM-PDU-TRANSFER.req

Sending of a RAN-INFORMATION-REQUEST, RAN-INFORMATION, RAN-INFORMATION-ACK, RAN-INFORMATION-APPLICATION-ERROR, RAN-INFORMATION-ERROR PDU to a BSS from an SGSN.

### 5.3.38 RIM-PDU-TRANSFER.ind

Reception of a RAN-INFORMATION-REQUEST, RAN-INFORMATION, RAN-INFORMATION-ACK, RAN-INFORMATION-APPLICATION-ERROR, RAN-INFORMATION-ERROR PDU at an SGSN from a BSS for routing of the PDU to another BSS.

5.3.39 (void)

5.3.40 (void)

5.3.41 (void)

5.3.42 (void)

5.3.43 (void)

5.3.44 (void)

### 5.3.45 MBMS-SESSION-START-REQUEST.req

Sending of an MBMS-SESSION-START-REQUEST PDU to a BSS from an SGSN requesting to start an MBMS session.

### 5.3.46 MBMS-SESSION-START-RESPONSE.cnf

Receipt of an MBMS-SESSION-START-RESPONSE PDU from a BSS acknowledging to start an MBMS session.

### 5.3.47 MBMS-SESSION-STOP-REQUEST.req

Sending of an MBMS-SESSION-STOP-REQUEST PDU to a BSS from an SGSN requesting to stop an MBMS session.

### 5.3.48 MBMS-SESSION-STOP-RESPONSE.cnf

Receipt of an MBMS-SESSION-STOP-RESPONSE PDU from a BSS acknowledging to stop an MBMS session.

### 5.3.49 MBMS-SESSION-UPDATE-REQUEST.req

Sending of an MBMS-SESSION-UPDATE-REQUEST PDU to a BSS from an SGSN requesting to update the MBMS service area list of an ongoing MBMS broadcast service session.

### 5.3.50 MBMS-SESSION-UPDATE-RESPONSE.cnf

Receipt of an MBMS-SESSION-UPDATE-RESPONSE PDU from a BSS acknowledging to update the MBMS service area list of an ongoing MBMS broadcast service session.

## 5.4 Primitive parameters

### 5.4.1 BSSGP Virtual Connection Identifier (BVCI)

BSSGP Virtual Connections (BVCs) provide communication paths between BSSGP entities. Each BVC is used in the transport of BSSGP PDUs between peer point-to-point (PTP) functional entities, peer point-to-multipoint (PTM) functional entities and peer signalling functional entities. Table 5.4.1 lists the mapping of the BSSGP PDU to the associated functional entity and the BVCI. The BVCI is used to enable the lower network service layer to efficiently route the BSSGP PDU to the peer entity. This parameter is not part of the BSSGP PDU across the Gb interface, but is used by the network service entity across the Gb.

Any BSSGP PDU received by the BSS or the SGSN containing a PDU type that does not fit, according to the mapping defined in table 5.4.1, with the functional entity identified by the BVCI provided by the network service entity, is discarded and a STATUS PDU with a cause value set to "Protocol error - unspecified" is sent.

A PTP functional entity is responsible for PTP user data transmission. There is one PTP functional entity per cell. Within the present document, a cell is identified by a BVCI unless it is explicitly stated otherwise.

A PTM functional entity is responsible for PTM user data transmission. There is one or more PTM functional entities per BSS.

A signalling functional entity is responsible for other functions e.g. paging. There is only one signalling entity per Network Service Entity (NSE). There is one or more NSEs per BSS.

Each BVC is identified by means of a BSSGP Virtual Connection Identifier (BVCI) which has end-to-end significance across the Gb interface. Each BVCI is unique between two peer Network Service Entities.

In the BSS, it shall be possible to configure BVCIs statically by administrative means, or dynamically. In case of dynamic configuration, the BSSGP shall accept any BVCI passed by the underlying Network Service entity.

At the SGSN side, BVCIs associated with PTP functional entities shall be dynamically configured. The BVCIs associated with signalling functional entities and PTM functional entities are statically configured.

The BVCI value 0000 hex shall be used for the signalling functional entities.

The BVCI value 0001 hex shall be used for the PTM functional entities.

All other values may be used freely by the BSS and shall be accepted by the SGSN.

**Table 5.4.1: BSSGP PDU, BVCI and functional entity mapping**

BSSGP PDU	Mapping of BVCI to functional entity
-----------	--------------------------------------

DL-UNITDATA	PTP
UL-UNITDATA	PTP
RA-CAPABILITY	PTP
DL-MBMS-UNITDATA	PTM
UL-MBMS-UNITDATA	PTM
PAGING-PS	PTP or SIGNALLING (note 1)
PAGING-CS	PTP or SIGNALLING (note 2)
RA-CAPABILITY-UPDATE / RA-CAPABILITY-UPDATE-ACK	PTP
RADIO-STATUS	PTP
SUSPEND / SUSPEND-ACK / SUSPEND-NACK	SIGNALLING
RESUME / RESUME-ACK / RESUME-NACK	SIGNALLING
FLUSH-LL / FLUSH-LL-ACK	SIGNALLING
LLC-DISCARDED	SIGNALLING
FLOW-CONTROL-BVC / FLOW-CONTROL-BVC-ACK	PTP
FLOW-CONTROL-MS / FLOW-CONTROL-MS-ACK	PTP
FLOW-CONTROL-PFC / FLOW-CONTROL-PFC-ACK	PTP
STATUS	PTP or PTM or SIGNALLING (note 3)
BVC-BLOCK / BVC-BLOCK-ACK	SIGNALLING
BVC-UNBLOCK / BVC-UNBLOCK-ACK	SIGNALLING
BVC-RESET / BVC-RESET-ACK	SIGNALLING
SGSN-INVOKE-TRACE	SIGNALLING
DOWNLOAD-BSS-PFC	PTP
CREATE-BSS-PFC / CREATE-BSS-PFC-ACK / CREATE-BSS-PFC-NACK	PTP
MODIFY-BSS-PFC / MODIFY-BSS-PFC-ACK	PTP
DELETE-BSS-PFC / DELETE-BSS-PFC-ACK / DELETE-BSS-PFC-REQ	PTP
PS-HANDOVER-REQUIRED / PS-HANDOVER-REQUIRED-ACK / PS-HANDOVER-REQUIRED-NACK	PTP
PS-HANDOVER-REQUEST / PS-HANDOVER-REQUEST-ACK / PS-HANDOVER-REQUEST-NACK	PTP
PS-HANDOVER-COMplete / PS-HANDOVER-COMplete-ACK	PTP
PS-HANDOVER-CANCEL	PTP
PERFORM-LOCATION-REQUEST / PERFORM-LOCATION-RESPONSE / PERFORM-LOCATION-ABORT	SIGNALLING
POSITION-COMMAND / POSITION-RESPONSE	SIGNALLING
RAN-INFORMATION-REQUEST/ RAN-INFORMATION/ RAN-INFORMATION-ACK/ RAN-INFORMATION-ERROR/ RAN-INFORMATION-APPLICATION-ERROR	SIGNALLING
MBMS-SESSION-START-REQUEST/ MBMS-SESSION-START-RESPONSE/ MBMS-SESSION-STOP-REQUEST/ MBMS-SESSION-STOP-RESPONSE/ MBMS-SESSION-UPDATE-REQUEST/ MBMS-SESSION-UPDATE-RESPONSE	SIGNALLING
MS-REGISTRATION-ENQUIRY/ MS-REGISTRATION-ENQUIRY-RESPONSE	SIGNALLING
NOTE 1: The network may initiate paging of an MS in READY mobility management state at an indication of a lower layer failure (see 3GPP TS 24.008 sub-clause 4.7.9.1). In this case, the BVCI=PTP may be used.	
NOTE 2: If the network initiates circuit-switched paging of a MS in READY mobility management state (e.g. a MS in class A or B mode of operation and in packet transfer mode), then the BVCI=PTP. If the MS is in STANDBY state, then the BVCI=SIGNALLING.	
NOTE 3: The setting of the BVCI is dependent upon the context within which the STATUS PDU was generated.	

## 5.4.2 Link Selector Parameter (LSP)

The link selector parameter is defined in 3GPP TS 48.016. At one side of the Gb interface, all BSSGP UNITDATA PDUs related to an MS shall be passed with the same LSP, e.g. the LSP contains the MS's TLLI, to the underlying network service. The LSPs used at the BSS and SGSN for the same MS may be set to different values.

## 5.4.3 [functional-name] PDU

The parameters that make up a [functional-name] PDU are defined in clause 10, "PDU Functional Definitions and contents".



#### 5.4.4 Network Service Entity Identifier (NSEI)

The Network Service Entity at the BSS and the SGSN provides the network management functionality required for the operation of the Gb interface. The Network Service Entity is described in 3GPP TS 48.016.

Each Network Service Entity is identified by means of a Network Service Entity Identifier (NSEI). The NSEI together with the BVCI uniquely identifies a BSGP Virtual Connection (e.g. a PTP functional entity) within an SGSN. The NSEI is used by the BSS and the SGSN to determine the NS-VCs that provides service to a BVCI.

#### 5.4.5 BSS Context

The SGSN can provide a BSS with information related to ongoing user data transmission. The information related to one MS is stored in a BSS context. The BSS may contain BSS contexts for several MSs. A BSS context contains a number of BSS packet flow contexts. A BSS packet flow context is identified by a packet flow identifier assigned by the SGSN. There are four pre-defined packet flows identified by four reserved packet flow identifier values. One pre-defined packet flow is used for best-effort service, one for signalling, one for SMS, and one for TOM8. The BSS shall not negotiate BSS packet flow contexts for these pre-defined packet flows with the SGSN.

NOTE: The TOM8 PFI is used to transfer LCS RRLP messages between the MS and the SGSN.

NOTE: PFC procedures (Create BSS PFC, Modify BSS PFC, Delete BSS PFC) and PS Handover procedures (PS Handover Required, PS Handover Request, PS Handover Complete) do not apply to pre-defined packet flows.

#### 5.4.6 MBMS Service Context

The SGSN can provide a BSS with information related to ongoing MBMS user data transmission. The information related to one MBMS Session is stored in an MBMS Service Context. A TMGI and optionally an MBMS Session Identity identify an MBMS Service Context. The BSS may contain MBMS Service Contexts for several MBMS Sessions.

#### 5.4.7 TLLI

The TLLI is used to uniquely identify a mobile station and needs to be included in a number of BSSGP PDUs across the Gb interface.

A change of TLLI may occur as a consequence of a P-TMSI reallocation. The new TLLI shall be used to address the mobile station after completion on the network side of the related GMM procedure (see 3GPP TS 24.008). However, the SGSN should not use the new TLLI for BSSGP addressing purposes towards the BSS either:

- until having signalled the change of TLLI to the BSS via the Downlink UNITDATA procedure (see sub-clause 6.1) or
- until having received from the BSS any BSSGP PDU including the new TLLI.

---

## 6 User data and signalling procedures between RL and BSSGP SAPs

### 6.1 Downlink UNITDATA procedure

On the downlink, a DL-UNITDATA PDU shall contain information elements to be used by the RLC/MAC function and an LLC-PDU. There shall be only one LLC-PDU per DL-UNITDATA PDU. The LLC-PDU shall always be the last information element in the DL-UNITDATA PDU, and shall be aligned on a 32 bit boundary for efficient processing.

An SGSN provides the BSSGP with a current TLLI, identifying the MS. If an SGSN provides a second TLLI, indicating that an MS has recently changed its TLLI, this shall be considered as the "old" TLLI. A BSS uses the "old" TLLI to locate an MS's existing context. Subsequent uplink data transfers for this MS shall reference the current TLLI, and not the old TLLI.

The SGSN shall include the IMSI in the PDU. As an exception, the SGSN may omit the IMSI in the PDU if the mobile station identified by the TLLI is in MM non-DRX mode period (i.e. during a GMM procedure for *GPRS attach* or *routing area updating* defined in 3GPP TS 24.008) and the SGSN does not have a valid IMSI.

The SGSN may include the *Service UTRAN CCO* (Cell Change Order) information element in the PDU (relevant if the network initiated cell change order to UTRAN, network initiated cell change order to E-UTRAN, PS handover to UTRAN or PS handover to E-UTRAN procedures are used). If this information element is received in multiple PDUs (either DL-UNITDATA PDU(s), CREATE-BSS-PFC PDU(s) or PS-HANDOVER-REQUEST PDU(s)), the information element contained in the last received PDU shall take precedence.

If the SGSN has valid DRX Parameters for a TLLI, then the SGSN shall include them in the PDU. Nevertheless, the SGSN can omit the DRX Parameters if the MS identified with the TLLI is in MM non-DRX mode period to speed up the transmission of the LLC-PDU on the radio interface. The SGSN shall not send a DL-UNITDATA PDU without the DRX Parameters IE if the MS identified with the TLLI is not in MM non-DRX mode period.

An exception case is when the SGSN has uplink and downlink Coverage Class information (previously received from the BSS in the UL-UNITDATA PDU) or eDRX information (negotiated during NAS signalling) or both available for a given MS in which case it shall proceed as follows when sending a DL-UNITDATA PDU for that MS:

- If uplink and downlink Coverage Class information is available for the MS then the SGSN shall include the Coverage Class information in the DL-UNITDATA. If a negotiated eDRX value is available then it shall also be included. The SGSN considers the eDRX to be negotiated upon accepting the eDRX cycle value requested by a MS during NAS signalling. If a negotiated eDRX value is not available but DRX information is available then it shall be included.
- If Coverage Class information is not available but a negotiated eDRX value is available for the MS then the SGSN shall include the negotiated eDRX value in the DL-UNITDATA PDU.
- The SGSN shall apply these rules also when sending a DL-UNITDATA PDU to a MS for which the GMM procedure for GPRS attach or routing area updating (defined in 3GPP TS 24.008) has not yet completed.

An SGSN provides the BSSGP with MS specific information, enabling the RLC/MAC entity in a BSS to transmit an LLC-PDU to the MS in a user specific manner. The information made available to the radio interface includes:

- MS Radio Access Capability. This defines the radio capabilities of the ME. If there is valid MS Radio Access Capability information known by the SGSN for the associated MS, the SGSN shall include it in the DL-UNITDATA PDU. Otherwise, MS Radio Access Capability shall not be present;
- Packet Flow Identifier. This identifies the packet flow context associated with the LLC PDU and is included by the SGSN if the packet flow context feature is negotiated. If the mobile station does not support the PFC feature or if the PFI is not known (e.g. the new SGSN did not get the PFI from the old SGSN during a RAU) then the SGSN shall use the pre-defined PFI to indicate best-effort QoS;
- QoS Profile. This defines the (peak) bit rate, the type of BSSGP's SDU (signalling or data), the type of LLC frame (ACK, SACK, or not), the precedence class, and the transmission mode to be used when transmitting the LLC-PDU across the radio interface;
- PDU Lifetime. This defines the remaining time period that the PDU is considered as valid within the BSS. If the PDU is held for a period exceeding the "PDU Lifetime" time period, the PDU shall be locally discarded. The PDU Lifetime is set within the SGSN by the upper layers.

A BSS may incorporate the PDU Lifetime, the Precedence and the (peak) bit rate into its radio resource scheduler. If the PFI is present then the BSS may incorporate the information from the associated ABQP into its radio resource scheduler. The algorithm to do this is out of scope of the present document.

If the PFI is known in the BSS and does not correspond to a predefined PFI, then:

- the (peak) bit rate and the precedence class fields present in the QoS Profile IE shall be ignored by the BSS;
- if the Allocation/Retention Priority was provided at the time the corresponding PFC was created or last modified, then the "Priority" IE, if present in the downlink UNITDATA PDU, is discarded.

Two types of BSSGP SDU are distinguished within the QoS Profile: layer 3 signalling and data. Layer 3 signalling may be transmitted over the Um interface with higher protection. If the MS has an RR connection to the network (see 3GPP TS 44.018), Layer 3 signalling may be transmitted over the Um interface on the main signalling link of the RR

connection, provided that the LLC PDU meets length restrictions imposed by the BSS. In this case, the BSS shall include the LLC PDU contained in the BSSGP PDU in the correspondent Layer 3 Um interface message (see 3GPP TS 44.018).

The type of LLC frame indicates if the LLC frame type is an ACK or SACK command/response, or not (see 3GPP TS 44.064). An ACK or SACK command/response frame type may be transmitted over the Um interface with higher protection.

Two transmission modes across the radio interface are possible: acknowledged (using RLC/MAC ARQ functionality) and unacknowledged (using RLC/MAC unitdata functionality). These transmission modes do not apply when the MS has an RR connection to the network and BSS uses the main signalling link of the RR connection, in which case the acknowledged transmission mode is used.

If Priority is present, assuming it shall not be discarded according to the rule above, only the priority-level field shall be regarded. The management of priority levels is implementation dependent and under operator control. The preemption capability indicator, the queuing allowed indicator and preemption vulnerability indicator shall be ignored in this case.

In addition to constructing the DL-UNITDATA, the SGSN supplies the LSP, the BVCI, the NSEI, and for an IP sub-network the NS Change IP endpoint, associated with the MS to the lower layer network service, enabling network service routing to the peer entity. These parameters are not transmitted as part of the BSSGP across the Gb-interface for the purpose of identifying the receiving endpoint (they are sent in the BSSGP Perform-Location-Request PDU to identify the serving cell of the target MS).

If the Gb-interface is supported using an IP sub-network, then the Resource Distribution function at the SGSN may transmit a BSSGP DL-UNITDATA PDU with an LLC-PDU Length Indicator set to 0. The BSS uses this DL-UNITDATA to change the IP endpoint at the SGSN to which any future UL-UNITDATA for the TLLI (indicated in the DL-UNITDATA) is sent. The LLC-PDU with a Length Indicator set to 0 is not sent across the radio interface.

In the case where localised service area is supported the SGSN may inform the BSS as to which LSA identities that the mobile has preferences by sending the LSA INFORMATION element. The BSS stores this information and uses it e.g. for network controlled cell re-selection when determining specific cell selection parameters for the mobile. The algorithm for determining specific cell selection parameters for the mobile is not defined further in the present document. The SGSN may inform the BSS about the contents of SPID in the DL-UNITDATA PDU. In this case the SPID is stored in the BSS.

When the 'Service Identification for improved Radio Utilization for GERAN' (SIRUG) feature (see clause 5.3.5.3 of TS 23.060 [7]) is supported, and the SGSN receives SCI information in the GTP-U header, the SGSN inserts the SCI IE and the GGSN/P-GW location IE in the associated DL-UNITDATA PDU(s). The BSS uses the Home PLMN ID contained within the IMSI and the GGSN/P-GW location information to determine whether or not it can handle the SCI information for that GGSN/P-GW. If it cannot, the BSS discards the SCI information and shall treat the rest of the DL-UNITDATA normally.

In abnormal cases, if the SCI IE is received but the GGSN/P-GW location IE is missing, then the BSS shall assume that the GGSN/P-GW is located in the VPLMN; and, if the GGSN/P-GW location IE is received but the SCI IE is missing, then the BSS shall ignore the GGSN/P-GW location IE.

Specific handling related to MOCN and GWCN configurations of network sharing, is described in sub-clauses 6.6 and 6.7.

When the SGSN is using a GWCN configuration, and the BSSGP DL-UNITDATA PDU contains a local TLLI, then the BSC shall use the registered Operator specific NRI value to identify the corresponding serving operator.

## 6.1.1 Abnormal conditions

The following actions are defined in periods of congestion.

To satisfy the maximum number of service requests, the BSS may redistribute MSs among cells (i.e. network controlled cell reselection is initiated). If this occurs, the BSS may inform the SGSN through the RADIO-STATUS PDU (Radio Cause value: cell reselection ordered). The BSS shall update any internal references that indicate the location of the MS. The BSS may attempt to internally re-route queued LLC frames to an MS that has been moved to a new cell. If this functionality is not supported, or if it is not possible to internally re-route LLC frames, the LLC frame shall be discarded.

It is the responsibility of the higher layer protocols in the SGSN to cope with discarded LLC frames.

## 6.2 Uplink UNITDATA procedure

On the uplink, a UL-UNITDATA PDU shall contain information elements derived from the RLC/MAC function (except when GTP is used in the Um interface, see 3GPP TS 44.018), meaningful to higher-layer protocols in an SGSN, and an LLC-PDU. There shall be only one LLC-PDU per UL-UNITDATA PDU. The LLC-PDU shall always be the last information element in the UL-UNITDATA PDU, and shall be aligned on a 32 bit boundary for efficient processing.

The BSS shall provide the TLLI associated to the MS to the SGSN.

The BSS shall provide a BVCI and an NSEI indicating the PTP functional entity (i.e. the cell) upon which the LLC-PDU was received. The SGSN shall obtain the BVCI, the NSEI, and in the case of an IP sub-network may obtain the LSP and the NS Change IP endpoint, from the underlying network service; the BVCI and the NSEI are not visible in the UL-UNITDATA PDU.

The BSS provides the SGSN with the QoS Profile used in the LLC-PDU transmission from the mobile station across the radio interface.

- QoS Profile. This reports the (peak) bit rate, the precedence used at radio access and the transmission mode used across the radio path. The type of the BSSGP SDU, layer 3 signalling or data, and the type of LLC frame, SACK, ACK, or not, are not meaningful on the uplink and shall be ignored.
- Packet Flow Identifier. This identifies the packet flow context that is obtained from the mobile. If the mobile station does not provide a PFI then the BSS shall use the pre-defined PFI to indicate best-effort QoS.

In order to support location based services, the BSS shall include the cell identifier of the cell upon which the LLC-PDU was received.

In the case where localised service area is supported, the BSS shall include the LSA identities of the cell upon which the LLC-SDU was received. The BSS may exclude LSA identities that are not included in the LSA INFORMATION element.

If EC-GSM-IoT is supported by the BSS and the SGSN, then the BSS shall provide in the UL-UNITDATA PDU:

- The uplink and downlink Coverage Class if the downlink Coverage Class is reported by the MS during system access see 3GPP TS 44.018 [25].
- The exception report flag if the UL-UNITDATA PDU contains an LLC PDU sent by the MS using an uplink EC TBF established in response to an EC PACKET CHANNEL REQUEST message indicating high priority (i.e. an exception report), see 3GPP TS 44.018 [25] and 3GPP TS 44.060 [22].
- The exception report flag if the UL-UNITDATA PDU contains an LLC PDU sent by the MS using an uplink EC TBF established in response to an EC PACKET DOWNLINK ACK/NACK message including channel request and indicating high priority (i.e. an exception report), see 3GPP TS 44.018 [25] and 3GPP TS 44.060 [22].

In addition to constructing the UL-UNITDATA, the BSS supplies the LSP, the NSEI, the BVCI, and for an IP sub-network the NS Change IP endpoint, associated with the MS to the lower layer network service, enabling network service routing to the peer entity. These parameters are not transmitted as part of the BSSGP across the Gb-interface. If the Gb-interface is supported using an IP sub-network, then the Resource Distribution function at the BSS may transmit a BSSGP UL-UNITDATA PDU with an LLC-PDU Length Indicator set to 0. The SGSN uses this UL-UNITDATA to

change the IP endpoint at the BSS to which any future DL-UNITDATA for the TLLI (indicated in the UL-UNITDATA) is sent.

Specific handling related to the use of network sharing in a cell is described in sub-clauses 6.6 and 6.7 for a mobile station non supporting network sharing. In the case of a mobile station supporting network sharing the BSS shall include the selected PLMN ID within the UL-UNITDATA PDU when a foreign TLLI or a random TLLI is included in the same UL-UNITDATA PDU, as described within sub-clause 10.2.2; both MS support and selected PLMN ID shall be derived by the BSS from information within the RLC data block as described within 3GPP TS 44.060 [22].

### 6.2.1 Abnormal conditions

None specified.

## 6.3 RA-CAPABILITY procedure

The SGSN stores an MS's current radio access capability (which may be changed by higher layer mobility management procedures). An MS's current radio access capability, and the TLLI identifying the MS, are conveyed to a BSS in a RA-CAPABILITY PDU. The received MS's radio access capability, if valid, shall then replace any radio access capability previously associated with the MS.

### 6.3.1 Abnormal conditions

If the BSS receives an unknown Access Technology Type in the MS Radio Access Capability field, it shall ignore the fields associated with that Access Technology type.

If the BSS receives unknown fields within a known Access Technology Type in the MS Radio Access Capability field, it shall ignore the unknown fields.

## 6.4 Downlink MBMS-UNITDATA procedure

On the downlink, a DL-MBMS-UNITDATA PDU shall contain information elements to be used by an LLC-PDU. There shall be only one LLC-PDU per DL-MBMS-UNITDATA PDU. The LLC-PDU shall always be the last information element in the DL-MBMS-UNITDATA PDU, and shall be aligned on a 32 bit boundary for efficient processing.

An SGSN provides the BSSGP with a current TMGI, if available, and MBMS Session Identity, identifying the MBMS Service Context.

The information made available to the radio interface includes:

- PDU Lifetime. This defines the remaining time period that the PDU is considered as valid within the BSS. If the PDU is held for a period exceeding the "PDU Lifetime" time period, the PDU shall be locally discarded. The PDU Lifetime is set within the SGSN by the upper layers.

A BSS may incorporate the PDU Lifetime into its radio resource scheduler.

In addition to constructing the DL-MBMS-UNITDATA, the SGSN supplies the BVCI and the NSEI to the BSS.

## 6.5 Uplink MBMS-UNITDATA procedure

On the uplink, a UL-MBMS-UNITDATA PDU shall contain an LLC-PDU. There shall be only one LLC-PDU per UL-MBMS-UNITDATA PDU. The LLC-PDU shall always be the last information element in the UL-MBMS-UNITDATA PDU, and shall be aligned on a 32 bit boundary for efficient processing.

The BSS shall provide the TMGI and, if present in the MBMS Service Context, the MBMS Session Identity to the SGSN in order to identify the MBMS session.

The BSS shall provide a BVCI and an NSEI indicating the PTM functional entity upon which the LLC-PDU was received. The SGSN shall obtain the BVCI, the NSEI, and in the case of an IP sub-network may obtain the LSP and the

NS Change IP endpoint, from the underlying network service; the BVCI and the NSEI are not visible in the UL-MBMS-UNITDATA PDU.

In addition to constructing the UL-MBMS-UNITDATA, the BSS supplies the LSP, the NSEI, the BVCI, and for an IP sub-network the NS Change IP endpoint, associated with the MBMS session to the lower layer network service, enabling network service routing to the peer entity. These parameters are not transmitted as part of the BSSGP across the Gb-interface. If the Gb-interface is supported using an IP sub-network, then the resource distribution function at the BSS may transmit a BSSGP UL-MBMS-UNITDATA PDU in order to change the IP endpoint at the BSS to which any future DL-MBMS-UNITDATA for the MBMS session (indicated with TMGI and, if available, MBMS Session Identity in the UL-MBMS-UNITDATA) shall be sent from the SGSN.

NOTE: In this version of the specification, the procedure is used for resource distribution only meaning that the LLC PDU length indicator shall always be set to zero.

## 6.6 Rerouting procedure in case of MOCN configuration for network sharing

### 6.6.1 General

This procedure shall be supported by a BSS if and only if it supports the MOCN configuration (see [43]). The rerouting procedure in a GWCN configuration is described in sub-clause 6.7.

In the MOCN configuration the radio access part of the network is shared. There may be more than one Gb-Interface towards the PS domain of different CN operators from the BSS.

Rerouting procedure is a mechanism used as part of the assignment of CN operator in shared networks with MOCN configuration or GWCN configuration (see sub-clause 6.7) when an MS not supporting network sharing performs initial attach/registration. In this case BSS may not know towards which SGSN to route the initial MS request message and the latter may be rerouted to another SGSN by BSS.

More precisely, in case of MOCN configuration, the selection of SGSN in BSS is based on the NRI (valid or invalid) or by random selection. In case where the SGSN cannot be deduced from the NRI and a *GPRS attach* or *routing area updating* initial layer 3 message (defined in [11]) shall be transferred in UL-UNITDATA message towards a SGSN, BSS shall choose a SGSN and initiate a rerouting procedure.

To trigger a rerouting procedure in MOCN configuration, the BSS adds the Redirect Attempt Flag IE to the UL-UNITDATA message, in order to indicate that the SGSN shall respond by including either Redirection Indication IE or Redirection Completed IE in DL-UNITDATA message.

### 6.6.2 Reroute Indication

If the UL-UNITDATA message does not contain the *CS Registered Operator* IE and the SGSN cannot serve the request and reroute is possible (error causes are related to subscription options - defined in [11]), the reject Layer 3 Information LLC-PDU (e.g. GPRS attach Reject) and a *Redirection Indication* IE containing a Reroute Reject Cause shall be included in the DL-UNITDATA message for the downlink direction.

When the IMSI, or in case the BSS supports CS/PS coordination enhancements, the *CS Registered Operator* IE or the *Selected Operator* IE, is not included in the UL-UNITDATA message and CS/PS domain registration coordination is required (see [43]), the Initial LLC-PDU and a *Redirection Indication* IE containing the Reroute Reject Cause set to 'CS/PS domain registration coordination required' shall be included in the DL-UNITDATA message for the downlink direction. CS/PS domain registration coordination may not be performed for the operator's own subscribers by the SGSN.

In addition the DL-UNITDATA message shall contain:

- The Initial LLC-PDU received from the MS;
- The IMSI, if available;
- The Unconfirmed send state variable, if available.

If the SGSN supports CS/PS coordination enhancements, the DL-UNITDATA message shall also contain:

- The Old Routing Area Identification as indicated by the MS in the Initial LLC-PDU or,
- The Attach Indicator in case the Initial LLC-PDU contains a GPRS attach (see [11]).

In a MOCN configuration, if the BSS does not support CS/PS coordination enhancements and the *Redirection Indication* IE in the DL-UNITDATA message is received from a SGSN which is not the last attempted, then the BSS shall re-initiate the procedure towards another CN operator when possible (or possibly to the same CN in case when CS/PS domain registration coordination is required), with the following additional information in the UL-UNITDATA message:

- The Initial LLC-PDU as LLC-PDU;
- The Redirect Attempt Flag IE;
- The IMSI, if received from one of previously attempted CN operators;
- The Unconfirmed send state variable, if received from previously attempted CN operator.

If the BSS supports CS/PS coordination enhancements and the *Redirection Indication* IE in the DL-UNITDATA message is received from a SGSN which is not the last attempted, it shall proceed as follows:

- if the DL-UNITDATA message contains the Old Routing Area Identification and the BSS from this information (and from BSS internal configuration) is able to uniquely identify one of the CN operators in the shared network, then the BSS shall re-initiate the procedure towards the SGSN of the identified CN operator with the Selected Operator, Initial LLC-PDU, Redirect Attempt Flag, IMSI and Unconfirmed send state variable (if received from previously attempted CN operator) included in the UL-UNITDATA message;
- if the DL-UNITDATA message contains the Old Routing Area Identification and the BSS from this information (and from BSS internal configuration) cannot identify one of the CN operators in the shared network, then the BSS shall initiate the MS Registration Enquiry procedure in the CS domain (see [14]);
- if the DL-UNITDATA message contains the Attach Indicator then the BSS shall initiate the MS Registration Enquiry procedure in the CS domain (see [14]).

NOTE: The configuration by means the BSS identifies a CN operator from the received Old Routing Area Identification is implementation dependent and under operator control.

If, as a result of the MS Registration Enquiry procedure in the CS domain, the MS is found to be registered with one of the shared CN operators, then the BSS shall re-initiate the procedure towards the SGSN of the same CN operator with the CS Registered Operator, Initial LLC-PDU, Redirect Attempt Flag, IMSI and Unconfirmed send state variable (if received from previously attempted CN operator) included in the UL-UNITDATA message.

If the MS is not found to be registered in the CS domain with any of the shared CN operators, then the BSS shall perform CS/PS domain registration coordination based on the received IMSI and re-initiate the procedure towards the SGSN of the identified CN operator with the Selected Operator, Initial LLC-PDU, Redirect Attempt Flag, IMSI and Unconfirmed send state variable (if received from previously attempted CN operator) included in the UL-UNITDATA message.

Upon reception of the downlink *Redirection Indication* IE, the BSS shall store as part of the Rerouting Function the associated Reroute Reject Cause and LLC-PDU related to this SGSN.

In case the Reroute Reject Cause is set to "CS/PS domain registration coordination required" and the BSS does not support CS/PS coordination enhancements, then the BSS shall perform CS/PS domain registration coordination based on the received IMSI. In this case the Reroute Reject Cause value and the associated LLC-PDU shall not be stored.

In case all attempted CN operators have replied with a *Redirection Indication* IE, the BSS shall select the most appropriate Layer 3 Information received from the attempted CN nodes based on the stored information as part of the Rerouting procedure and send it back to the MS (see [11]).

### 6.6.3 Reroute complete

If the SGSN can serve the request, the *Redirection Completed* IE with outcome value set to "MS is accepted" or "MS is already registered" and Layer 3 Information LLC-PDU (e.g. GPRS Attach Accept) shall be included in the DL-UNITDATA message for the downlink direction.

Upon reception of the UL-UNITDATA message containing the *CS Registered Operator* IE, the SGSN supporting CS/PS coordination enhancements shall conclude the Rerouting procedure and include the *Redirection Completed* IE in the DL-UNITDATA message.

Upon reception of the downlink *Redirection Completed* IE, the BSS shall send back the included LLC-PDU to the MS and terminate the Rerouting procedure.

### 6.6.4 Abnormal Conditions

If the SGSN cannot serve the request and rerouting is not possible, the *Redirection Completed* IE with outcome value set to "MS is not accepted" and Layer 3 Information LLC-PDU (e.g. GPRS Attach Reject) shall be included in the DL-UNITDATA message for the downlink direction.

If, as a result of the analysis of the DL-UNITDATA message, the MS Registration Enquiry procedure is initiated in the CS domain and the MSC does not support CS/PS coordination enhancements, then the BSS shall behave as if the MS is not registered with the CN operator of that MSC.

## 6.7 Rerouting procedure in case of GWCN configuration for network sharing

### 6.7.1 General

This procedure shall be supported by a BSS and an SGSN if and only if both nodes support CS/PS coordination enhancements in a GWCN configuration (see 3GPP TS 23.251 [43]). The rerouting procedure in a MOCN configuration is described in sub-clause 6.6.

In the GWCN configuration the radio access part of the network as well as the core network nodes (MSC and SGSN) are shared between the different CN operators.

Rerouting procedure is a mechanism used as part of the assignment of a CN operator in a shared network when a MS not supporting network sharing performs initial attach/registration. Upon reception of the initial MS request message, the BSS may not know which CN operator to select and thus which CN operator to forward the initial MS request message to. If the initial MS request is not accepted by the CN operator selected by the BSS, a reroute of the initial MS request message to another CN operator within the shared network may be needed.

More precisely, the selection of a CN operator in the BSS is based on the NRI (valid or invalid) or by random selection. In case the CN operator cannot be deduced from the NRI and a *GPRS attach* or *routing area updating* initial layer 3 message (defined in [11]) shall be transferred in the UL-UNITDATA message, the BSS shall select a CN operator and initiate the rerouting procedure.

To trigger a rerouting procedure in a GWCN configuration, the BSS includes the Redirect Attempt Flag IE in the UL-UNITDATA message. By including the Redirect Attempt Flag IE in the UL-UNITDATA message, the SGSN supporting GWCN shall respond by including either the Redirection Indication IE or the Redirection Completed IE in the DL-UNITDATA message.

### 6.7.2 Reroute indication

If the UL-UNITDATA message does not contain the *CS Registered Operator* IE and the CN operator selected by the BSS cannot serve the MS and rerouting is possible (error causes are related to subscription options - defined in [11]), the reject Layer 3 Information (e.g. GPRS Attach Reject) and a *Redirection Indication* IE containing a Reroute Reject Cause shall be included in the DL-UNITDATA message for the downlink direction.

When neither the *CS Registered Operator* IE nor the *Selected Operator* IE is included in the UL-UNITDATA message and CS/PS domain registration coordination is required (see 3GPP TS 23.251 [43]), the Initial LLC-PDU and a



*Redirection Indication* IE containing the Reroute Reject Cause set to 'CS/PS domain registration coordination required' shall be included in the DL-UNITDATA message for the downlink direction. CS/PS domain registration coordination may not be performed by the SGSN for the operator's own subscribers.

In addition the DL-UNITDATA message shall contain:

- The Initial LLC-PDU received from the MS;
- The IMSI, if available;
- The Unconfirmed send state variable, if available.
- The Old Routing Area Identification as indicated by the MS in the Initial LLC-PDU or,
- The Attach Indicator in case the Initial LLC-PDU contains a GPRS attach (see 3GPP TS 24.008 [11]).

If the DL-UNITDATA message containing the *Redirection Indication* IE is not related to the last attempted CN operator, then the BSS shall proceed as follows:

- if the DL-UNITDATA message contains the Old Routing Area Identification and the BSS from this information (and from BSS internal configuration) is able to uniquely identify one of the CN operators in the shared network, then the BSS shall re-initiate the procedure towards the identified CN operator with the Selected Operator, Initial LLC-PDU, Redirect Attempt Flag, IMSI and Unconfirmed send state variable (if received from previously attempted CN operator) included in the UL-UNITDATA message;
- if the DL-UNITDATA message contains the Old Routing Area Identification and the BSS from this information (and from BSS internal configuration) cannot identify one of the CN operators in the shared network, then the BSS shall initiate the MS Registration Enquiry procedure in the CS domain (see 3GPP TS 48.008 [14]);
- if the DL-UNITDATA message contains the Attach Indicator then the BSS shall initiate the MS Registration Enquiry procedure in the CS domain (see 3GPP TS 48.008 [14]).

NOTE: The configuration by means the BSS identifies a CN operator from the received Old Routing Area Identification is implementation dependent and under operator control.

If, as a result of the MS Registration Enquiry procedure in the CS domain, the MS is found to be registered with one of the shared CN operators, then the BSS shall re-initiate the procedure towards the same CN operator with the CS Registered Operator, Initial LLC-PDU, Redirect Attempt Flag, IMSI and Unconfirmed send state variable (if received from previously attempted CN operator) included in the UL-UNITDATA message.

If the MS is not found to be registered in the CS domain with any of the shared CN operators, then the BSS shall perform CS/PS domain registration coordination based on the received IMSI and re-initiate the procedure towards the SGSN of the identified CN operator with the Selected Operator, Initial LLC-PDU, Redirect Attempt Flag, IMSI and Unconfirmed send state variable (if received from previously attempted CN operator) included in the UL-UNITDATA message.

Upon reception of the *Redirection Indication* IE, the BSS shall store as part of the Rerouting Function the associated Reroute Reject Cause and LLC-PDU related to this CN operator.

In case all attempted CN operators have replied with a *Redirection Indication* IE, the BSS shall select the most appropriate Layer 3 Information received from the attempted CN operators based on the stored information as part of the Rerouting procedure and send it back to the MS (see 3GPP TS 24.008 [11]).

### 6.7.3 Reroute complete

If the selected CN operator accepts the initial request from the MS, then the SGSN shall respond to the BSS with the *Redirection Completed* IE, with the Outcome value field set to "MS is accepted" or "MS is already registered", and the Layer 3 Information LLC-PDU (e.g. GPRS Attach Accept) included in the DL-UNITDATA message.

Upon reception of the UL-UNITDATA message containing the *CS Registered Operator* IE, the SGSN shall conclude the Rerouting procedure and include the *Redirection Completed* IE in the DL-UNITDATA message.

Upon reception of the DL-UNITDATA message with the *Redirection Completed* IE included in the message, the BSS shall send the LLC-PDU to the MS and terminate the Rerouting procedure.

## 6.7.4 Abnormal Conditions

If the selected CN operator cannot serve the initial request from the MS and rerouting to another CN operator is not possible, then the SGSN shall send the DL-UNITDATA message to the BSS with the Outcome value field set to "MS is not accepted" within the *Redirection Completed* IE, and the Layer 3 Information LLC-PDU (e.g. GPRS Attach Reject) included in the message.

If, as a result of the analysis of the DL-UNITDATA message, the MS Registration Enquiry procedure is initiated in the CS domain and the MSC does not support CS/PS coordination enhancements, then the BSS shall behave as if the MS is not registered with any of the CN operators of that MSC.

---

# 7 Signalling procedures between GMM SAPs

## 7.1 Paging procedure

When an SGSN initiates the paging procedure for GPRS services as defined in 3GPP TS 24.008, it shall send one or more PAGING-PS PDUs to the BSS.

When instructed by an MSC/VLR to initiate a paging procedure for non-GPRS services as defined in 3GPP TS 24.008, an SGSN shall send one or more PAGING-CS PDUs to the BSS.

These paging PDUs shall contain the information elements necessary for the BSS to initiate paging for an MS within a group of cells.

The SGSN provides an indication of the cells within which the BSS shall page the MS. The levels of resolution within one BSS are: all cells within the BSS, all cells on the BSS within one location area, all cells on the BSS within one routing area, and one BVCI (i.e. cell). A routing area, a location area, or a BSS area is associated with one or more NSEIs. If the cells in which to page the MS are served by several NSEIs then one paging PDU must be sent to each of these NSEIs.

A paging PDU shall be used to generate the corresponding radio interface paging request message(s) to be transmitted at the appropriate time.

It should be noted that each paging PDU relates to only one MS and therefore a BSS may pack pages for different MSs into the relevant 3GPP TS 24.008 or 3GPP TS 44.060 radio interface paging request messages.

In the case of paging for non-GPRS services, the SGSN shall provide the MS's IMSI and DRX Parameters. The SGSN shall also include the Global CN-Id information element in the paging PDU when this information element is received from the MSC/VLR. The Global CN-Id information element is received from the MSC/VLR if paging using only the IMSI parameter as identifier of the MS is performed via the SGSN when the MSC/VLR applies intra domain connection of RAN nodes to multiple CN nodes as described in 3GPP TS 23.236. The BSS shall then buffer this information element until receiving the paging response from the MS in order to route the paging response to the correct MSC/VLR.

In the case of paging for GPRS services, the SGSN shall provide the MS's IMSI. If DRX Parameters are available, the SGSN shall also provide the DRX Parameters. If eDRX Parameters are available, the SGSN shall also provide the eDRX Parameters (see sub-clause 7.1a).

**NOTE:** The IMSI and the DRX Parameters enable the BSS to derive the paging population number. Paging without DRX parameters may require a considerable extension of the paging duration.

An SGSN may provide the BSSGP with MS specific information, enabling a BSS to execute the paging procedure in an MS specific manner. This includes:

- QoS Profile. The Precedence parameter is set by the upper layers (in the SGSN). The SGSN shall set the bit rate parameter to "best effort". The SGSN shall set the transmission mode to unacknowledged. The BSS shall ignore the received bit rate, the BSSGP SDU type, LLC type, and transmission mode parameters;
- PFI or an aggregate BSS QoS profile information which indicates if the page is for signalling, for SMS, for TOM8, for best-effort, or for a specific packet flow. The aggregate BSS QoS profile in this case is used for

paging only and is not stored by the BSS. If both of the optional PFI and ABQP IEs are present, the ABQP takes precedence.

- the most recently received downlink Coverage Class and the cell identity for the cell where the Coverage Class was reported by the MS, if previously received from the BSS in the UL-UNITDATA PDU.
- MS Radio Access Capability defining the radio capabilities of the MS. If there is valid MS Radio Access Capability information known by the SGSN for the associated MS, the SGSN shall include it in the PAGING-PS PDU. Otherwise, the MS Radio Access Capability shall not be present.
- Paging Attempt Information consisting of Paging Attempt Count and Intended Number of Paging Attempts information. If Paging Attempt Information is provided then the Paging Attempt Count field shall be increased by one at each new paging attempt performed for delivering a packet data payload available for delivery. If the SGSN cannot determine the number of intended paging attempts the SGSN shall use the code point 0000 corresponding to 'Information not available'.

If an SGSN provides a P-TMSI in a PAGING-PS PDU, then the BSS shall use the P-TMSI to address the MS. If the SGSN does not provide the P-TMSI in the PAGING-PS PDU, then the BSS shall use the IMSI to address the MS.

If the BSS determines that the nominal paging group of the MS occurs too far into the future (e.g. the BSS is unable to buffer the paging request until the next occurrence of the nominal paging group for the indicated MS) it responds to the PAGING-PS PDU by sending a PAGING-PS-REJECT PDU to the SGSN and includes information indicating the time until the next paging occasion therein.

If an SGSN provides a TLLI in a PAGING-CS PDU and a radio context identified by the TLLI exists within the BSS, then the paging request message shall be directly sent to the MS. If the SGSN does not provide the TLLI in the PAGING-CS PDU or if no radio context identified by the TLLI exists within the BSS, then the BSS shall use the TMSI, if provided in the PAGING-CS PDU, else the IMSI, to address the MS.

The PAGING-CS PDU consists of the parameters described above for a PAGING-PS PDU (except the P-TMSI, PFI, ABQP and QoS profile parameters) and, optionally, some or all of the following parameters; TMSI, TLLI, Global CN-Id, Channel Needed and eMLPP-Priority. The Channel Needed and eMLPP-Priority information shall be handled transparently by the BSS.

The SGSN may send the BSS a DUMMY-PAGING-PS PDU at any time to determine the time until the next paging occasion for the MS indicated therein. The BSS uses the information provided within the DUMMY-PAGING-PS PDU to calculate the time until the next paging occasion for the indicated MS and includes it within a DUMMY-PAGING-PS-RESPONSE PDU it sends back to the SGSN.

## 7.1a Paging procedure for Extended Coverage and eDRX

An SGSN may have any combination of uplink and downlink Coverage Class information (previously received from the BSS in an UL-UNITDATA PDU) and eDRX information (negotiated during NAS signalling) available for a given MS when it determines that paging is necessary for that MS.

### 7.1a.1 Coverage Class and eDRX information available

If uplink and downlink Coverage Class information and a negotiated eDRX value are available for the MS the SGSN sends the BSS a PAGING-PS PDU that indicates the available uplink and downlink Coverage Class information and the negotiated eDRX information.

- If a cell in the area targeted for paging supports EC-GSM-IoT the MS is paged on the EC-PCH of its EC\_CCCH\_GROUP using the indicated downlink Coverage Class and eDRX information (see 3GPP TS 45.002 [48]).
- If a cell in the area targeted for paging does not support EC-GSM-IoT the MS is paged on the PCH using the indicated eDRX information if the MS Radio Access Capability IE (see sub-clause 11.3.22) indicates that the MS supports GPRS/EGPRS. The MS is not paged if the MS Radio Access Capability IE indicates that the MS does not support GPRS/EGPRS.

### 7.1a.2 Coverage Class information not available, eDRX information available

If uplink and downlink Coverage Class information is not available but a negotiated eDRX value is available for the MS the SGSN sends the BSS a PAGING-PS PDU that indicates the negotiated eDRX information. The MS is paged on the PCH, using the indicated eDRX information, in the cell(s) in the area targeted for the paging.

### 7.1a.3 Coverage Class information available, eDRX information not available

If uplink and downlink Coverage Class information is available but a negotiated eDRX value is not available for the MS the SGSN sends the BSS a PAGING-PS PDU that indicates the available Coverage Class and DRX information (if available).

- If a cell in the area targeted for paging supports EC-GSM-IoT the MS is paged on the EC-PCH of its EC\_CCCH\_GROUP (see 3GPP TS 45.002 [32]) using the indicated downlink Coverage Class information and the lowest eDRX cycle.
- If a cell in the area targeted for paging does not support EC-GSM-IoT the MS is paged on the PCH using DRX (the SGSN may include DRX information in the PAGING-PS PDU) if the MS Radio Access Capability IE indicates that the MS supports GPRS/EGPRS. The MS is not paged if the MS Radio Access Capability IE indicates that the MS does not support GPRS/EGPRS.

## 7.2 Radio Access Capability Update procedure

The BSS may request an MS's current Radio Access capability and/or its IMSI by sending to an SGSN a RA-CAPABILITY-UPDATE PDU which includes the TLLI of the MS and a Tag. The allocation of the Tag is implementation specific. The BSS then starts timer T5.

The SGSN shall respond by sending a RA-CAPABILITY-UPDATE-ACK PDU which includes the TLLI of the MS, the Tag received in the corresponding RA-CAPABILITY-UPDATE PDU, and an RA-Cap-UPD-Cause field; the IMSI of the MS is also included when known. The BSS shall stop timer T5.

If the RA-Cap-UPD-Cause is set to "OK", then an MS Radio Access Capability field and the IMSI shall be present. The received MS's radio access capability, if valid, shall then replace any radio access capability previously associated with the MS. If the RA-Cap-UPD-Cause is not set to "OK", then neither the MS Radio Access Capability nor the IMSI shall be present in the RA-CAPABILITY-UPDATE-ACK PDU.

### 7.2.1 Abnormal conditions

If an SGSN receives a RA-CAPABILITY-UPDATE PDU which includes an unknown TLLI, it shall answer with a RA-CAPABILITY-UPDATE-ACK PDU which includes the RA-CAP-UPD-Cause set to the value "TLLI unknown".

If an SGSN receives a RA-CAPABILITY-UPDATE PDU which includes a known TLLI, but there are no Radio Access parameters or IMSI known to the SGSN for the associated MS, the SGSN shall reply to the request with a RA-CAPABILITY-UPDATE-ACK PDU in which the RA-CAP-UPD-Cause is set to: "no RA capability or IMSI available".

If a BSS receives a RA-CAPABILITY-UPDATE-ACK PDU containing a Tag which is different from the last transmitted Tag by the BSS, it shall ignore the reception of this PDU.

If a BSS sends a RA-CAPABILITY-UPDATE PDU to an SGSN and the RA-CAPABILITY-UPDATE-ACK is not returned within a period T5 with the same Tag value as provided in the request, the RA-CAPABILITY-UPDATE procedure shall be repeated a maximum of RA-CAPABILITY-UPDATE-RETRIES attempts. The Tag value shall be changed by the BSS at each new retry.

## 7.3 Radio Status procedure

A BSS and an MS radio interface communication status may change due to the following:

- 1) the MS goes out of coverage and is lost;

This condition is signalled by setting the Radio Cause value to "Radio contact lost with MS".

- 2) the link quality is too bad to continue the communication;

This condition is signalled by setting the Radio Cause value to "Radio link quality insufficient to continue communication".

- 3) the BSS has ordered the MS to perform a cell reselection.

This condition is signalled by setting the Radio Cause value to "Cell reselection ordered".

- 4) the BSS is preparing to order the MS to perform a cell-reselection to a new cell and internal re-routing of packets to the new cell is not possible.

This condition is signalled by setting the Radio Cause value to "Cell reselection preparation".

- 5) the BSS has detected that the packet cell change order has failed.

This condition is signalled by setting the Radio Cause value to "Cell reselection failure".

Conditions 1) and 2) indicate that attempts to communicate between an MS and an SGSN via this cell should be suspended or abandoned. An SGSN shall stop sending LLC-PDUs to the cell for the MS. The criteria for deciding whether condition 1) or 2) has occurred is not in the scope of the present document.

The conditions for resuming a suspended or abandoned communication between an MS and SGSN are defined in 3GPP TS 24.008.

Condition 3) indicates that the SGSN should wait for a cell update before resuming the transmission of LLC-PDUs to the BSS.

Condition 4) indicates that the SGSN shall suspend downlink transmission of LLC-PDUs. This condition shall only be signalled if the Enhanced Radio Status feature has been negotiated. For this condition the SGSN shall wait for either:

- a) a cell update from the MS in a new Cell . In this case the SGSN should resume downlink transmission in the new Cell.
- b) or a new RADIO-STATUS PDU from the BSS with a different Radio Cause value. In this case the SGSN should follow the procedures specified for that Radio Cause value.

Condition 5) indicates that the SGSN shall resume the transmission of LLC-PDUs to the BSS in case the downlink transmission has been suspended. This condition shall only be signalled if the Enhanced Radio Status feature has been negotiated. A BSS shall signal these exception conditions to an SGSN by sending a RADIO-STATUS PDU. It shall contain a reference to the MS, either TLLI or TMSI or IMSI, and an indication of the exception condition, i.e. the Radio Cause value.

After receipt of a RADIO-STATUS PDU with cause value indicating Condition 1-4, the SGSN may try to locate the mobile station in case any downlink LLC PDU needs to be sent to the mobile station, as it can not expect to receive systematically an uplink LLC PDU from the mobile station or a RADIO-STATUS PDU with cause value indicating Condition 5 from the BSS to resume the downlink transfer. To this avail, the SGSN should send a PAGING-PS PDU towards the mobile station.

## 7.4 SUSPEND procedure

If the MS signals to the BSS that it wishes its GPRS service to be suspended, the BSS shall send a SUSPEND PDU to the SGSN and start timer T3. Actions within the SGSN while an MS is suspended are not specified, but paging is typically stopped. The SUSPEND PDU contains:

- the TLLI of the MS; and
- the Routing Area of the MS as received in the Layer 3 Um interface message GPRS Suspension Request (see 3GPP TS 44.018).

For each SUSPEND PDU received by an SGSN, a SUSPEND-ACK PDU shall be returned to the BSS. Upon reception of the SUSPEND-ACK PDU, the BSS shall stop T3. The SUSPEND-ACK PDU contains:

- the TLLI of the MS as received in the SUSPEND PDU;
- the Routeing Area of the MS as received in the SUSPEND PDU; and
- the Suspend Reference Number.

The SGSN generates the Suspend Reference Number in a manner that it enables it to differentiate between different SUSPEND PDUs relating to the same MS.

### 7.4.1 Abnormal conditions

If a SUSPEND-ACK PDU is not received for a SUSPEND PDU within T3 seconds, then the SUSPEND PDU procedure shall be repeated a maximum of SUSPEND-RETRIES attempts. After SUSPEND-RETRIES attempts the procedure is stopped and the O&M system is informed.

If a SUSPEND-ACK PDU is received for an MS that is already marked as suspended, then the SUSPEND-ACK PDU is ignored.

If a SUSPEND PDU refers to an MS which is unknown in the SGSN, then a SUSPEND-NACK PDU is returned containing a cause value (Cause value: Unknown MS). The BSS shall stop the SUSPEND procedure.

If the Suspend procedure is supported on the Gn interface, in case of an inter-SGSN suspend procedure the MS shall not be treated as unknown in the SGSN when the RA indicated in the SUSPEND PDU is not served by the SGSN.

## 7.5 RESUME procedure

When the reason why a GPRS-attached MS was suspended disappears, i.e.:

- it leaves dedicated mode, disconnecting the MS from the MSC; or
- it is handed over to a cell that supports DTM;

the BSS shall either a) instruct the MS to initiate the Routeing Area Update procedure, or b) signal to the SGSN that an MS's GPRS service shall be resumed.

If the BSS executes a), then no further action is required.

If the BSS executes b), then the BSS shall send a RESUME PDU containing the same Suspend Reference Number received in the SUSPEND-ACK PDU to the SGSN and start timer T4. The RESUME PDU contains:

- the TLLI of the MS;
- the Routeing Area of the MS; and
- the Suspend Reference Number.

For each RESUME PDU received by an SGSN, a RESUME-ACK PDU shall be returned to the BSS. Upon reception of the RESUME-ACK PDU, the BSS shall stop T4. The RESUME-ACK PDU contains:

- the TLLI of the MS; and
- the Routeing Area of the MS.

### 7.5.1 Abnormal conditions

If a RESUME-ACK PDU is not received for a RESUME PDU within T4 seconds, then the RESUME PDU procedure shall be repeated a maximum of RESUME-RETRIES attempts. After RESUME-RETRIES attempts the procedure is stopped, the O&M system is informed and the MS shall be instructed to initiate the Routeing Area Update procedure.

If a RESUME-ACK PDU is received for an MS that is not suspended, then the RESUME-ACK PDU is ignored.

If a RESUME PDU refers to an MS which is unknown in the SGSN, then a RESUME-NACK PDU is returned containing a cause value (Cause value: Unknown MS). The BSS shall stop the RESUME procedure and the MS shall be instructed to initiate the Routing Area Update procedure.

## 7.6 MS Registration Enquiry

### 7.6.1 General

This procedure shall be supported by a BSS if it supports CS/PS coordination enhancements in a MOCN configuration (see sub-clause 6.6) or in a GWCN configuration (see sub-clause 6.7).

The purpose of the MS Registration Enquiry procedure is to acquire registration information for a given MS from the core network. More precisely, triggered e.g. by the Rerouting procedure in the CS domain (see 3GPP TS 48.008 [14]), the BSS sends an enquiry to the SGSN(s) whether a given MS is already registered with any of the core network operators in the shared network.

### 7.6.2 Registration enquiry

The MS Registration Enquiry procedure is triggered by the BSS sending the MS REGISTRATION ENQUIRY message to the SGSN containing the IMSI for the MS for which the registration enquiry concerns.

To avoid a possible change of serving operator when the MS performs inter-RAT mobility from E-UTRAN to GERAN (see 3GPP TS 23.251 [43]), the MS registration enquiry may also need to be sent from the SGSN to the MME of the same CN operator. For this reason the BSS includes the MME Query indicator in the MS REGISTRATION ENQUIRY message.

The MS REGISTRATION ENQUIRY message is sent to each SGSN connected to the BSS. However, in order to minimise the signalling in the core network, the MME Query indicator shall only be included in one of the MS REGISTRATION ENQUIRY messages addressing the same CN operator.

The SGSN responds with the MS REGISTRATION ENQUIRY RESPONSE message indicating whether the MS is served by (one of) the CN operator(s) sharing the network.

### 7.6.3 Registration response

If the MS is found to be registered with (one of) the CN operator(s) sharing the network, the SGSN shall return the MS REGISTRATION ENQUIRY RESPONSE message to the BSS with the IMSI and the PS Registered Operator IE (containing the serving CN operator) included in the message.

If the MS is not registered with (any of) the sharing CN operator(s), the SGSN excludes the PS Registered Operator IE from the MS REGISTRATION ENQUIRY RESPONSE message.

Upon reception of the MS REGISTRATION ENQUIRY RESPONSE message with the PS Registered Operator IE included in the message, the BSS may terminate the MS Registration Enquiry procedure regardless if one or more SGSNs have not yet responded to the MS REGISTRATION ENQUIRY message.

---

## 8 Signalling procedures between NM SAPs

### 8.1 FLUSH-LL (logical link) procedure

When an SGSN detects a cell change of an MS from a cell update or a routing area update, the SGSN shall send a FLUSH-LL PDU to the old BVC to initiate the following procedures:

- at a cell change within one NSE (e.g. the BSS is a NSE) and within one routing area, LLC-PDU(s) for a given TLLI stored at an "old" BVCI (corresponding to the old cell) are either deleted or transferred to a "new" BVCI (corresponding to the new cell) with which the TLLI is currently associated; or

- at a cell change between two NSEs within one routing area, LLC PDU(s) for a given TLLI stored at an "old" BVC (corresponding to the old cell) are either deleted or transferred to a "new" BVC (corresponding to the new cell) with which the TLLI is currently associated. In that case, transferring of LLC PDU(s) can only be requested by the SGSN if the NSE underlying the "old" BVC indicated support for the "Inter-NSE re-routing";
- at a cell change within the same routing area, and within one NSE or between two NSEs, the on-going location procedure, if any, is either maintained in the BSS after the cell reselection or aborted by the BSS towards the SMLC; or
- at a cell change between two routing areas, LLC-PDU(s) stored at the "old" BVC for the TLLI are deleted.

The SGSN provides the BSSGP with:

- a MS's TLLI identifying the MS;
- the "old" BVC identifying the cell in which to find buffered LLC-PDU(s) for the MS;
- the "new" BVC identifying the cell to which the MS is currently associated (only when within the same routing area); and
- if the SGSN supports "Inter-NSE re-routing" or "LCS Procedures" and the old NSE supports the "Inter-NSE re-routing" or "LCS Procedures", the "new" NSEI identifying the cell to which the MS is currently associated (only when within the same routing area but between two NSEs). The NSEI associated to the "old" BVC shall be assumed if the "new NSEI" field is not provided.

If there is a BSS context for the MS in the "old" BVC and there is a "new" BVC in the FLUSH-LL PDU, the BSS shall interpret this as a request to transfer the BSS context to the new cell. The BSS shall assume that the ABQP that was negotiated for each PFC in the "old" BVC is requested in the "new" BVC by the SGSN. Also, the values of the Packet Flow Timer and the Service UTRAN CCO Information Elements should be kept for each transferred PFC. If, when receiving the BSS context at the "new" BVC, the BSS has already obtained the information related to one or several PFC(s) from the SGSN by means of the Create BSS PFC procedure (see sub-clause 8a.1), then the BSS shall disregard the information corresponding to this (these) PFC(s) within the BSS context transferred from the "old" BVC. If a Create BSS PFC procedure is ongoing when receiving the BSS context at the "new" BVC, the BSS shall either apply the received information or carry on with the currently used ABQP until the procedure completes.

If a "new" BVC is not provided, then the FLUSH-LL PDU shall be interpreted as an instruction to delete the queued LLC-PDU(s) at the old BVC, and also to delete the BSS context associated to the MS identified by the TLLI, if any exists in the "old" BVC.

Queued BSSGP signalling, e.g. pages, shall not be affected by this procedure.

In response to a FLUSH-LL PDU the BSS shall send a FLUSH-LL-ACK PDU to the SGSN containing:

- the TLLI received in the FLUSH-LL PDU;
- an indication of whether the LLC-PDU(s) were "transferred" or "deleted". In case the SDUs were "transferred" the BVC (new) IE, and the NSEI (new) IE if present in the FLUSH-LL PDU, shall be included;
- the number of octets that have been transferred or deleted.

NOTE: In situations where the BSS was unable to transfer the queued LLC-PDUs upon a transfer request from the SGSN, the BSS may indicate in the FLUSH-LL-ACK PDU a flush action set to "deleted" together with the number of octets actually deleted.

On receipt of a FLUSH-LL-ACK PDU by the SGSN, indicating that the LLC-PDU(s) associated with the old BVC have been "deleted", the SGSN may choose to:

- immediately retransmit all unacknowledged LLC-PDU(s) (in acknowledged LLC operation) to the MS at the new BVC (i.e. new cell); or
- rely on LLC retransmission mechanism to transmit unacknowledged LLC-PDU(s).

On receipt of a FLUSH-LL-ACK PDU by the SGSN, indicating that the LLC-PDU(s) associated with the old BVC have been "transferred", the SGSN shall not take any of the above actions.



If the "new" BVCI could not accept the QoS characteristics of all PFCs of the BSS context, the BSS context shall still be transferred and the BSS shall then initiate in the "new" BVCI a Modify BSS PFC procedure for each PFC for which the requested ABQP could not be accepted. The BSS may resume the transfer of downlink LLC PDU(s) before the Modify BSS PFC procedure is completed.

In order to avoid desequencing DL LLC PDU (in LLC acknowledged or unacknowledged operation) during the FLUSH procedure, upon sending a FLUSH-LL PDU to the BSS requesting the rerouting of DL LLC PDUs to a new cell, the SGSN should wait for the receipt of the FLUSH-LL-ACK PDU or rely on an internal guard timer, before starting to transmit subsequent DL LLC PDUs on the new BVCI. In the case the SGSN does not request the BSS to reroute DL LLC PDUs to a new cell, it may immediately resume the transmission of subsequent DL LLC PDUs on the new BVCI, or start the Create BSS PFC procedure, without waiting for the receipt of the FLUSH-LL-ACK PDU.

### 8.1.1 Abnormal Conditions

If the BSS receives a FLUSH-LL PDU for an unknown BVCI or TLLI not associated with the given BVCI, then the FLUSH-LL PDU is discarded and no FLUSH-LL-ACK PDU is returned.

If the SGSN does not receive a FLUSH-LL-ACK PDU in response to a FLUSH-LL PDU, no further action is taken.

## 8.2 Flow Control procedure

### 8.2.1 General model of operation

From the perspective of the BSSGP, the flow control mechanism is based on the following model:

- there is a downlink buffer for each BVC, as identified by a BVCI, in a BSS;
- the transfer of BSSGP UNITDATA PDUs for an MS from the SGSN is controlled by the BSS; and
- only downlink BSSGP UNITDATA PDU transfer to the BSS is managed via flow control procedures. Uplink flow control is not performed.

### 8.2.2 Mode of operation

The flow control mechanism manages the transfer of BSSGP UNITDATA PDUs sent by the SGSN on the Gb interface to the BSS.

The BSS shall control the flow of BSSGP UNITDATA PDUs to its BVC buffers by indicating to the SGSN the maximum allowed throughput in total for each BVC. The BSS shall control the flow of BSSGP UNITDATA PDUs to the BVC buffer for an individual MS by indicating to the SGSN the maximum allowed throughput for a certain TLLI. If the PFC Flow Control feature is negotiated, the BSS may control the flow of BSSGP UNITDATA PDUs to the BVC buffer for a certain PFC of an individual MS by indicating to the SGSN the maximum allowed throughput for a certain PFI.

If the Gigabit Interface feature has been negotiated, the granularity of the Flow Control related information elements such as the *BVC Bucket Size IE*, the *BVC Bucket Leak Rate IE* and the *PFC flow control parameters IE* shall be indicated through the *Flow Control Granularity IE* included in the same PDU (see sub-clauses 10.4.4, 10.4.6 and 10.4.24).

The BSS uses flow control to adjust the flow of BSSGP UNITDATA PDUs to a BVC buffer. The amount of buffered BSSGP UNITDATA PDUs in the BSS should be optimised to efficiently use the available radio resource. The volume of buffered BSSGP UNITDATA PDUs for a BVC or MS or PFC should be low. BSSGP UNITDATA PDUs queued within the BSS that are not transferred across the radio interface before the PDU Lifetime expires shall be locally deleted from the BSS. The local deletion of BSSGP UNITDATA PDUs in the BSS shall be signalled to the SGSN by the transmission of a LLC-DISCARDED PDU.

For each FLOW-CONTROL PDU received by an SGSN, a confirmation shall always be sent across the Gb interface by the SGSN. The confirmation uses the Tag that was received in the FLOW-CONTROL PDU, which was set by the BSS to associate the response with the request. When receiving no confirmation to a FLOW-CONTROL PDU, the reasons that gave rise to the triggering of a flow control message may trigger another message, or, if the condition disappears, it

may not. For the repetition of non-confirmed FLOW-CONTROL PDUs, the maximum repetition rate still applies in the BSS.

## 8.2.3 Flow Control of Traffic from an SGSN to BSS

### 8.2.3.1 Control of the downlink throughput by the SGSN

The principle of the BSSGP flow control procedures is that the BSS sends to the SGSN flow control parameters which allow the SGSN to locally control its transmission output in the SGSN to BSS direction. The SGSN shall perform flow control on each BVC, on each MS and optionally on each PFC for an MS. The flow control is performed on each LLC-PDU first by the PFC flow control mechanism if applicable and if negotiated, then by the MS flow control mechanism and then by the BVC flow control mechanism.

If the PFC Flow Control feature has been negotiated and the LLC-PDU corresponds to a PFC for which the SGSN has received some flow control parameters, then the SGSN has to check that the LLC-PDU is passed by the individual PFC flow control. If it is passed or if the PFC flow control has not been negotiated, or if it has been negotiated but no flow control parameter has been received for the PFC corresponding to the LLC-PDU, the SGSN applies the MS flow control. If passed, the SGSN finally applies the BVC flow control to the LLC-PDU. If an LLC-PDU is passed by all flow control mechanisms, the entire LLC-PDU is delivered to the Network Services for transmission to the BSS (see figure 8.1).

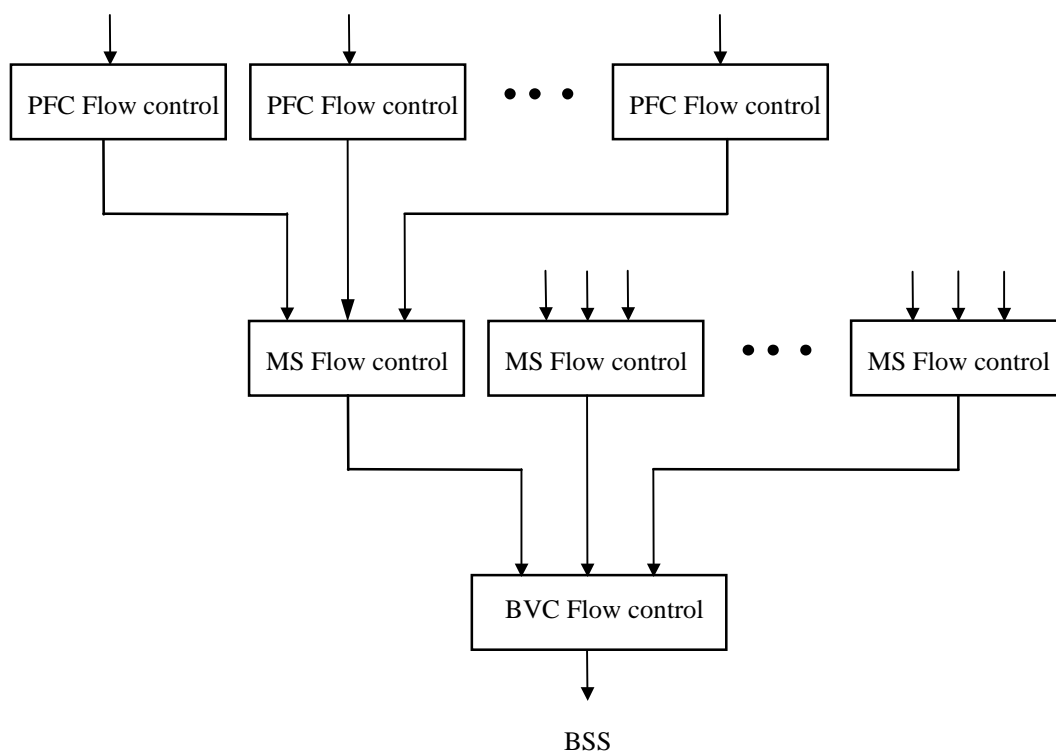

**Figure 8.1: BSSGP Flow control**

The flow control parameters sent by the BSS to the SGSN consist of the following information:

- the bucket size ( $B_{max}$ ) for a given BVC or MS or PFC in the downlink direction; and
- the bucket leak rate ( $R$ ) for a given BVC or MS or PFC in the downlink direction; and
- the bucket full ratio for a given BVC or MS or PFC in the downlink direction, if the Current Bucket Level (CBL) feature is negotiated.

NOTE: The information for a given PFC is only received if the PFC flow control feature is negotiated.

The SGSN shall perform flow control on an individual MS using SGSN determined values of Bmax and R unless it receives a FLOW-CONTROL-MS PDU from the BSS regarding that MS. The SGSN shall continue to perform flow control for a particular MS using the Bmax and R values received from the BSS for at least Th seconds after receiving a FLOW-CONTROL-MS PDU from the BSS regarding that MS. When timer Th has expired or when the MS changes cells, the SGSN may reinitialise the SGSN internal flow control variables for that MS and begin to use SGSN generated values for Bmax and R.

The SGSN shall start performing flow control on a given PFC for an individual MS as soon as it receives the first FLOW-CONTROL-PFC PDU for that PFC and the feature has been negotiated; it shall stop applying PFC flow control for a given PFC of an individual MS as soon as it receives subsequently a FLOW-CONTROL-MS PDU for that MS or if more than Tf seconds have elapsed since the last FLOW-CONTROL-PFC PDU was received for that PFC. When the MS changes cells, the SGSN shall stop performing flow control per PFC, until it receives a FLOW-CONTROL-PFC PDU .

In case the MS flow control parameters needs to be updated and the PFC flow control feature is negotiated and the PFC flow control parameters for that MS remains unchanged then the FLOW-CONTROL-PFC PDU is used by the BSS to update the MS flow control parameters. The "Number of PFCs" IE within the "PFC Flow Control parameters" IE shall be set to "0" in this case.

The BSSGP flow control model is the algorithm shown in Figure 8.2. The model of the algorithm is that an LLC-PDU is passed by the algorithm as long as the bucket counter (B) plus the length of the LLC-PDU does not exceed the bucket size Bmax. When the LLC-PDU is passed, the LLC-PDU length is added to B. Any PDU not transmitted is delayed until B plus the LLC-PDU length is less than Bmax.

### 8.2.3.2 Flow Control Conformance Definition

A BSSGP flow control algorithm shall be implemented in the SGSN. The BSSGP flow control conformance algorithm is defined in figure 8.2.

The conformance definition is used to decide which LLC-PDUs are conforming to the flow to the PFC of an MS, to an MS or in a BSSGP virtual connection (BVC) over the Gb interface. The conformance definition should not be interpreted as the required implementation algorithm, as the SGSN manufacturer may use any algorithm as long as the operation of the BSSGP flow control does not violate the objectives of compliant BVCs or MSs or PFC. That is, the SGSN shall never transmit more data than can be accommodated within the BSS buffer for a BVC or individual MS or for a given PFC of an MS.

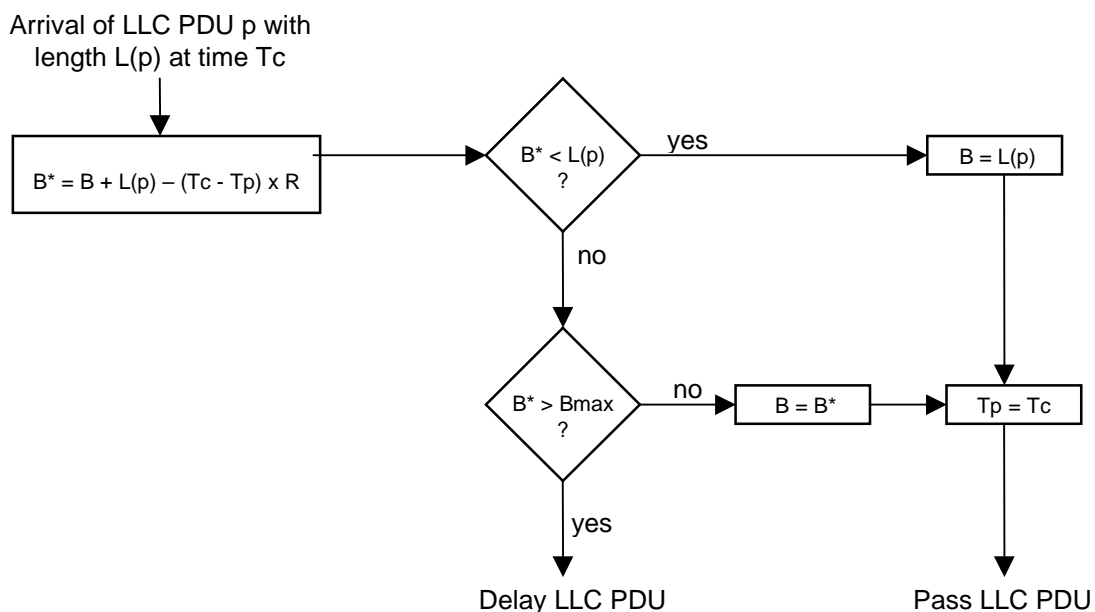

Figure 8.2: Conformance Definition Algorithm for BSSGP Flow Control

The variables used by the algorithm are:

Bmax	Bucket Size. Set by the BSS for each cell and each mobile station and optionally for each PFC of an MS. Bmax shall be large enough to accommodate at least one LLC-PDU;
R	leak rate of the bucket;
B	bucket counter;
B*	predicted value of the bucket counter;
L(p)	length of LLC-PDU p;
Tp	the time that the last LLC-PDU p was transferred; and
Tc	arrival time of LLC-PDU p.

The initial conditions of these variables in the SGSN are:

- Bmax = 0 for BVCs or MSs. For BVCs, this value is valid until Bmax is received in the FLOW-CONTROL-BVC. For MSs, this value is valid until Bmax\_default\_MS is received in the FLOW-CONTROL-BVC PDU. Thereafter, sub-clause 8.2.3.6, shall apply;
- Bmax = 0 for PFCs until a FLOW-CONTROL-BVC PDU is received for the cell in which the PFC is running. Thereafter, Bmax for a PFC shall not be greater than Bmax of the corresponding MS until PFC flow control applies for the PFC. As long as PFC flow control applies, Bmax shall then not be greater than the value of Bmax provided in the latest valid FLOW-CONTROL-PFC PDU ;
- R = 0 for BVC or MSs. For a BVC, this value is valid until a FLOW-CONTROL-BVC PDU is received. For an MS, this value is valid until a FLOW-CONTROL-BVC PDU is received. Thereafter, sub-clause 8.2.3.6 shall apply;
- R = 0 for PFCs until a FLOW-CONTROL-BVC PDU is received for the cell in which the PFC is running. Thereafter, R for a PFC shall not be greater than R of the corresponding MS until PFC flow control applies for the PFC. As long as PFC flow control applies, R shall then not be greater than the value of R provided in the latest valid FLOW-CONTROL-PFC PDU ;
- B = 0 (the bucket is empty); and Tp = the current time for the first LLC-PDU.

The SGSN shall not transmit a LLC-PDU on a BVC until a FLOW-CONTROL-BVC PDU is received from the BSS for that BVC.

When a LLC-PDU p arrives at current time Tc, the variable B\* is set to the predicted bucket size if the LLC-PDU were to be transferred to the BSS. This is given by the previous bucket size plus the new LLC-PDU size,  $B^* = B + L(p)$ , less the amount that the bucket will have leaked away since the last compliant LLC-PDU,  $R \times (Tc - Tp)$ . If this is less than L(p) then the LLC-PDU is compliant and the bucket size B is reset to L(p) and the LLC-PDU is passed. When a compliant LLC-PDU is passed the last LLC-PDU transfer time is set to the current time,  $Tp = Tc$ .

If the bucket has not completely leaked away then the bucket has to be checked to see if the limit Bmax is going to be exceeded,  $B^* > Bmax$ . If the limit is exceeded then the LLC-PDU is non compliant and is delayed for some time period, and no updates are done on the variables. If the bucket limit Bmax is not exceeded then the LLC-PDU is compliant and the bucket counter (B) is set equal to the value of B\*. When a conforming LLC-PDU is passed then the last LLC-PDU transfer time is set to the current time,  $Tp = Tc$ .

On receipt of a FLUSH-LL-ACK PDU by the SGSN, indicating that the LLC-PDU(s) associated with the old BVC have been "deleted", the SGSN should update the value of the bucket counter (B) for the MS and for the old BVC,  $B = \max(B - N, 0)$ . N is provided by FLUSH-LL-ACK PDU, indicating the number of octets deleted by the BSS.

On receipt of a FLUSH-LL-ACK PDU by the SGSN, indicating that the LLC-PDU(s) associated with the old BVC have been "transferred" within the NSE, the SGSN should update the value of the bucket counter (B) for the old BVC,  $B = \max(B - N, 0)$ . The value of B for the new BVC should also be updated,  $B = \min(B + N, Bmax)$ . N is provided by FLUSH-LL-ACK PDU, indicating the number of octets transferred by the BSS.

On receipt of a LLC-DISCARDED PDU by the SGSN, indicating that the LLC-PDU(s) associated with the MS or the PFC of an MS have been locally deleted by the BSS, the SGSN should update the value of the bucket counter (B) for the MS or the PFC and for the BVC,  $B = \max(B - N, 0)$ . N is provided by LLC-DISCARDED PDU, indicating the number of octets deleted by the BSS.

The BSS may update the values of Bmax and R within the SGSN at any time by transmitting a new Flow Control PDU containing the new Bmax and R values. The variables B, B\*, Tp and Tc are local to the SGSN and are not affected by the reception of a Flow-Control-BVC or Flow Control-MS PDU.

If the Current Bucket Level (CBL) feature is negotiated, the SGSN shall update the variable B based upon the Bucket\_Full\_Ratio information element received in the Flow Control PDU. During the time period when SGSN does not receive a Flow Control PDU, it shall continue computing the bucket counter (B) as defined above.

### 8.2.3.3 Response time within the SGSN to flow control messages

Upon reception of flow control requests from a BSS, the SGSN shall modify its downlink transmission as instructed within 100 ms.

### 8.2.3.4 Frequency of sending BVC or MS or PFC Flow Control PDUs

The rate at which the BSS is allowed to send flow control PDUs for a given BVC or MS or PFC is limited and defined by the following rule: the BSS may send a new Flow Control PDU every C seconds, where C is a value which is pre-defined and common to the BSS and SGSN.

If the BSS detects a missing FLOW-CONTROL-ACK PDU from the SGSN and the condition which causes the sending of a FLOW-CONTROL PDU still remains, the FLOW-CONTROL PDU may be retransmitted immediately. In this case the BSS may violate the repetition rate defined by the C value.

After a BVC reset procedure, the BSS may send a BVC-BLOCK PDU. Otherwise, the BSS shall send a BVC-FLOW-CONTROL PDU. When the blocked BVC is unblocked, a BVC-FLOW-CONTROL PDU shall be sent.

### 8.2.3.5 FLOW-CONTROL PDUs

Based on the criteria for flow control, a BSS shall send to an SGSN a FLOW-CONTROL PDU containing a list of IEs.

For BVC Flow Control, the following information is sent:

- the maximum bucket size (Bmax) for the BVC on the Gb Interface;
- the leak rate parameter (R) to be applied to the bucket;
- the bucket full ratio to resynchronize the bucket counter for the BVC, if the Current Bucket Level (CBL) feature is negotiated;
- the default MS bucket size (Bmax\_default\_MS);
- the default MS leak rate (R\_default\_MS); and
- the optional measurement of the delay for PDU delivery inside that BVC.

For MS Flow Control, the following information is sent:

- the TLLI identifying the MS;
- the maximum bucket size (Bmax) for this MS on the Gb interface;
- the leak rate parameter (R) to be applied to the bucket; and
- the bucket full ratio to resynchronize the bucket counter for the MS, if the Current Bucket Level (CBL) feature is negotiated.

For PFC Flow Control, the following information is sent:

- the TLLI identifying the MS;

- the maximum bucket size (Bmax) for this MS on the Gb interface (optional);
- the leak rate parameter (R) to be applied to the bucket (optional);
- the bucket full ratio to resynchronize the bucket counter for the MS, if the Current Bucket Level (CBL) feature is negotiated (optional);
- the number of PFCs for which flow control parameters are included;

for each PFC:

- the PFI identifying the PFC for that MS;
- the maximum bucket size (Bmax) for this PFC on the Gb interface;
- the leak rate parameter (R) to be applied to the bucket;
- the bucket full ratio to resynchronize the bucket counter for the PFC, if the Current Bucket Level (CBL) feature is negotiated.

NOTE: The supply of the MS flow control parameters inside the FLOW-CONTROL-PFC PDU allows the SGSN utilising the most up-to-date parameters both for PFC and MS flow control. Also, because the receipt of a FLOW-CONTROL-MS PDU notifies the end of PFC flow control for a given MS, if the MS flow control parameters have changed since the last update, then it is necessary to provide the MS flow control parameters inside the FLOW-CONTROL-PFC PDU.

### 8.2.3.6 Condition of Bmax for MS after Initial Flow-Control-BVC

The SGSN may use the following (informative) equation to generate an initial bucket size, Bmax, for an MS.

$$B_{\max} \text{ (bits)} = \min(R_{\text{default\_MS for 1 s}}, 72\,000, \max(\text{MS throughput for 1 s}, (\text{max MS throughput for 1 s} + \text{current throughput of all other MSs in the cell for 1 s}) / \text{number of MSs in the cell}))$$

where, the number of MSs in the cell includes the MS being added.

Under no circumstance shall the SGSN use a value of Bmax greater than Bmax\_default\_MS for an MS unless it receives a FLOW-CONTROL-MS PDU from the BSS for that MS.

The SGSN shall not use a leak rate (R) for an MS greater than R\_default\_MS unless it receives a FLOW-CONTROL-MS PDU from the BSS for that MS.

## 8.2.4 Flow Control of Uplink Traffic from a BSS to an SGSN

No flow control procedures are defined between the BSS and the SGSN in uplink direction.

## 8.3 BVC blocking and unblocking procedure

### 8.3.1 PTP BVC

The following statement applies only for PTP BVC.

The BVC blocking and unblocking procedures are initiated by the BSS to remove from use, or bring in to use, a BVC.

A BSS may block one BVC because of:

- operation and Maintenance intervention for a cell;
- equipment failure at the BSS;
- cell equipment failure at the BSS; or
- other causes not regarded in phase 1 of the implementation of GPRS (Cause Value: "reserved for future use").

When a BSS wishes to block a BVC, the BSS shall mark that BVC as blocked, thereafter discarding any traffic sent to the BVC in the uplink direction. The cell associated with the BVC should not accept data in the downlink direction. The BSS shall send a BVC-BLOCK PDU to the SGSN and start timer T1. The BVC-BLOCK PDU contains:

- the BVCI of the BVC to be blocked; and
- a Cause element indicating the reason for blocking (typical cause values: O&M intervention, Equipment failure).

On receipt of a BVC-BLOCK PDU, the SGSN shall mark the indicated BVC as blocked and stop transmitting traffic addressed to this BVC. The SGSN shall then acknowledge the blocking of the BVC by sending a BVC-BLOCK-ACK PDU to the BSS.

The BVC-BLOCK-ACK PDU contains the BVCI received in the BVC-BLOCK PDU.

On receipt of the BVC-BLOCK-ACK PDU the BSS shall stop timer T1.

The BVC shall be seen as blocked by an SGSN until a BVC-UNBLOCK PDU is received indicating that the BVC's status has changed.

During the BVC blocking procedure, traffic in transit to or from a cell is in an indetermined state and may be lost. When unblocking a BVC both the BSS and SGSN shall be in an operational state, i.e. the underlying network service and the BVC shall be available for use.

If a BSS wishes to unblock a blocked BVC it shall send a BVC-UNBLOCK PDU, and start timer T1.

The BVC-UNBLOCK PDU contains:

- the BVCI of the BVC to be unblocked.

If a BVC-UNBLOCK PDU is received by an SGSN for a blocked BVC, the BVC shall be marked as unblocked and a BVC-UNBLOCK-ACK PDU shall be returned to the BSS, containing the BVCI received in the BVC-UNBLOCK PDU.

The BSS shall stop timer T1 on receipt of the BVC-UNBLOCK-ACK PDU and mark the BVC as unblocked.

### 8.3.2 Signalling BVC

The blocking and unblocking procedure is not applicable for the signalling BVC. The signalling BVC shall never be blocked.

### 8.3.3 Abnormal Conditions

The following statements apply only for a signalling BVC.

If a BVC-BLOCK PDU is received by an SGSN for the signalling BVC, the PDU is ignored.

If a BVC-BLOCK-ACK PDU is received by a BSS for the signalling BVC, the PDU is ignored.

If BVC-UNBLOCK PDU is received by an SGSN for the signalling BVC, the PDU is ignored.

If BVC-UNBLOCK-ACK PDU is received by an BSS for the signalling BVC, the PDU is ignored.

The following statements apply only for PTP BVC.

If a BVC-BLOCK-ACK PDU is not received for a BVC-BLOCK PDU within T1 seconds, then the BVC-BLOCK PDU procedure shall be repeated a maximum of BVC-BLOCK-RETRIES attempts. After BVC-BLOCK-RETRIES attempts the BVC remains blocked, the procedure is stopped and the O&M system is informed.

If a BVC-UNBLOCK-ACK PDU is not received for a BVC-UNBLOCK PDU within T1 seconds, then the BVC-UNBLOCK PDU procedure shall be repeated a maximum of BVC-UNBLOCK-RETRIES attempts. After BVC-UNBLOCK-RETRIES attempts the status of the BVC remains blocked, the procedure is stopped and the O&M system is informed.

If traffic is received on a BVC that is marked at a BSS or at an SGSN as blocked, and no BVC-Unblocking procedure is pending, the received PDU shall not be accepted and a STATUS PDU (Cause value: BVC blocked) shall be sent to the

peer entity on the signalling BVC. The STATUS PDU shall indicate the BVCI of the BVC upon which the error was detected.

If a BVC-BLOCK PDU is received by an SGSN for a blocked BVC, a BVC-BLOCK-ACK PDU shall be returned.

If a BVC-UNBLOCK PDU is received by an SGSN for an unblocked BVC, a BVC-UNBLOCK-ACK PDU shall be returned.

If an unexpected BVC-BLOCK-ACK PDU is received by a BSS, and it is related to a BVC that is locally blocked, the BVC-BLOCK-ACK PDU is discarded. If the BVC-BLOCK-ACK PDU is related to a BVC that is not locally blocked, then a BVC unblock procedure shall be performed.

If an unexpected BVC-UNBLOCK-ACK PDU is received by a BSS and it is related to a BVC that is locally not blocked, the BVC-UNBLOCK-ACK PDU is discarded. If the BVC-UNBLOCK-ACK PDU is related to a BVC that is locally blocked, then a BVC block procedure shall be performed.

## 8.4 BVC-RESET procedure

The purpose of the BVC-RESET procedure is to synchronise the initialisation of GPRS BVC related contexts at a BSS and SGSN. This enables the BSS and SGSN to begin communication in known states. A BVC-RESET procedure is performed because of recovery procedures related to:

- a system failure in the SGSN or BSS that affects GPRS BVC functionality (e.g. processor recovery);
- an underlying network service system failure; or
- a change in the transmission capability of the underlying network service, where the "change" is from zero kbps to greater-than-zero kbps;
- a change in mapping between the BVCI and cell identifier.

The BSS may also send BVC-RESET as a means to create the initial mapping between BVCI and cell identifications.

After any of the possible events stated above, the status of the affected BVCs may be inconsistent at the SGSN and the BSS. After performing the BVC Reset procedure all affected BVCs are assumed to be unblocked at the SGSN. The reset procedure forces a consistent state upon SGSN and BSS by requiring that after the completion of the BVC-Reset procedure the BSS initiates the block procedure for all affected BVCs that are marked as blocked at the BSS.

Before a BSS (or SGSN) sends a BVC-RESET PDU, the operational status of the associated network service shall be obtained by the BSS (or SGSN).

If the associated network service is operational, the BSS (or SGSN) shall send a BVC-RESET PDU to its peer entity and start timer T2. The BSS (or SGSN) may receive BVC related signalling and UNITDATA PDUs before the procedure is acknowledged, but shall not transmit PDUs.

If the associated network service is not operational, the BVC-RESET procedure is postponed until internal periodic status checks indicate that it is operational.

The BVC-RESET PDU contains:

- the BVCI of the reset BVC;
- a cause element indicating the reason for reset;
- the cell identifier, when the reset is for a PTP BVC and BSS is initiator of the reset;
- feature bitmap, when the reset is for a signalling BVC.

After the SGSN (or BSS) has initialised all affected GPRS related contexts, a BVC-RESET-ACK PDU is returned.

The BVC-RESET-ACK PDU contains:

- the BVCI of the reset BVC;
- the cell identifier, when the reset is for a PTP BVC and SGSN is initiator of the reset.



Upon reception by a BSS (or SGSN) of the BVC-RESET-ACK PDU the timer T2 is stopped.

### 8.4.1 Signalling BVC

After any failure affecting the NSE, the party (BSS or SGSN) where the failure resided shall reset the signalling BVC. After sending or receiving a BVC-RESET PDU for the signalling BVC, the BSS shall stop all traffic and initiate the BVC-RESET procedure for all BVCs corresponding to PTP functional entities of the underlying network service entity. The BSS must complete the BVC-RESET procedure for signalling BVC before starting PTP BVC-RESET procedures.

The Feature bitmap is sent to identify the optional features that can be supported by the network service entity. After completion of the signalling BVC-RESET procedure both entities shall locally determine the common set of optional features supported by both NSEs. This is done by performing the bit AND operation of the received Feature bitmap with its own Feature bitmap.

If the Feature bitmap IE is missing in a signalling BVC-RESET or BVC-RESET-ACK PDU or if the result of the AND operation is '0' then no optional features are activated.

After sending or receiving a BVC-RESET PDU for the signalling BVC, the SGSN shall stop all traffic in the PTP BVCs of the corresponding NSE.

### 8.4.2 PTP BVC

After any failure affecting only part of the BVC functionality not including the signalling BVC the party where the failure resided shall reset only the affected BVCs.

If the BSS was the initiator of the BVC-RESET procedure, the BSS may initiate the blocking procedure upon receipt of a BVC-RESET-ACK PDU. If the SGSN was the initiator of the BVC-RESET procedure while the affected BVC is marked as blocked at the BSS side, the BSS shall initiate the BVC-Blocking procedure after having returned the BVC-RESET-ACK PDU to the SGSN.

Upon reception of a BVC-RESET PDU, the SGSN (or BSS) shall discard UNITDATA PDUs addressed to the reset BVC.

After reset of a PTP BVC, UNITDATA PDUs addressed to the BVC may then be received and transmitted, unless it is blocked.

### 8.4.3 Abnormal Conditions

The following statements are valid for both signalling and PTP BVC.

If a BSS (or SGSN) sends a BVC-RESET PDU to an SGSN (or BSS) and the BVC-RESET-ACK PDU is not returned within a period T2, the BVC-RESET procedure shall be repeated a maximum of BVC-RESET-RETRIES attempts. After BVC-RESET-RETRIES attempts the procedure is stopped and the O&M system is informed. In case of PTP BVC, the status of all affected BVCs at the BSS (or SGSN) shall be blocked as a consequence.

If the BSS receives a BVC-RESET PDU for a BVCI which is unknown in the BSS, then the BSS shall return a STATUS PDU towards the SGSN including the BVCI and the cause value 'BVCI unknown'.

If the BSS (or SGSN) has sent a BVC-RESET PDU for a BVCI to the SGSN (or BSS) and is awaiting a BVC-RESET-ACK PDU in response, but instead receives a BVC-RESET PDU indicating the same BVCI, then this shall be interpreted as a BVC-RESET ACK PDU and the T2 timer shall be stopped.

The BVC\_RESET for signalling BVC overrides all pending procedures for PTP BVC, i.e. other pending procedures are stopped and corresponding running timers are stopped.

If the BSS (or SGSN) receives an unexpected BVC-RESET ACK PDU, this shall be ignored.

If the BSS has sent a BVC-UNBLOCK PDU and receives a BVC-RESET PDU before the BVC-UNBLOCK-ACK PDU has been received from the SGSN, then the BSS shall consider the corresponding BVC marked as unblocked.

## 8.5 Trace procedure

The purpose of the trace invocation procedure is to inform the receiving entity that it should begin producing a trace record on an MS. The trace is invoked by an SGSN by sending an SGSN-INVOKE-TRACE PDU to the peer entity. The SGSN-INVOKE-TRACE PDU is not acknowledged.

The events and parameters to be recorded are indicated in the "Trace type" information element are defined in 3GPP TS 32.008.

The remaining elements, when received, are to be passed transparently to the OMC receiving the trace record.

The element "OMCId", if present, indicates the OMC to which the record is destined.

The PDU includes a trace reference which is allocated by the entity which triggered the trace.

The element "TriggerId", if present, indicates the entity which triggered the trace.

The Trace Reference and TriggerId IEs are used to tag the trace record to allow simpler construction of the total record by the entity which combines trace records.

## 8.6 Overload Control procedure

### 8.6.1 General

This procedure is defined to control the traffic to the SGSN from BSC when the SGSN is in an overload situation.

The philosophy used at BSS side is:

- If T15 is not running and an OVERLOAD PDU including the *Priority Class Indicator* IE is received, then traffic for the indicated priority class should be reduced by one step. At the same time, timers T15 and T16 should be started.
- During T15, all received OVERLOAD PDU should be ignored.
- If T16 expires, the traffic should be increased by one step and T16 should be re-started unless full load has been resumed.
- The number of steps and the method of reducing/increasing the load are considered to be an implementation specific function.

### 8.6.2 Overload Operation

The SGSN could indicate to the BSS that it is in a congested state by sending an OVERLOAD PDU and request the BSS to reduce the traffic for the category of MSs indicated in the *Priority Class Indicator* IE.

The BSS receiving the OVERLOAD PDU shall assume the SGSN sending the PDU as being in an overloaded state and reduce the traffic to the SGSN using the algorithm described in sub-clause 8.6.1.

The amount of traffic could be reduced by using the Access Control Class in the system information message defined in 3GPP TS 44.018. However it is implementation specific regarding how the BSS reduces the traffic in response to receiving an OVERLOAD PDU.

## 8a Signalling procedures between PFM SAPs

### 8a.1 Create BSS PFC procedure

#### 8a.1.0 General

If the BSS receives a request to transfer an uplink or downlink LLC PDU for which it currently does not have a BSS packet flow context and the PFI does not indicate best-effort or SMS or TOM8 or signalling then the BSS should send a DOWNLOAD-BSS-PFC PDU to the SGSN and start timer T6. In the uplink case the TLLI, optional Radio Priority, and optional Packet Flow ID are received from the MS as defined in 3GPP TS 44.060. Until the BSS receives the BSS PFC the BSS shall handle uplink and downlink transfers according to a best-effort default aggregate BSS QoS profile. For uplink transfers the best-effort default profile is specific to the radio priority level.

If the BSS receives a request to transfer an uplink or downlink LLC PDU associated to a PFI indicating best-effort or SMS or TOM8 or signalling then the BSS may handle the corresponding transfer according to an operator-defined aggregate BSS QoS profile. Indeed the latter cannot be negotiated with the SGSN for those flows. It is also up to the implementation what Allocation/Retention Priority is granted to those flows.

If the BSS does not receive a PFI from the MS, e.g. from a R97 or R98 MS, the BSS shall not send a DOWNLOAD-BSS-PFC PDU to the SGSN. In this case the QoS Profile IE is utilized instead.

Following a DOWNLOAD-BSS-PFC PDU if there is not an ongoing Delete PFC procedure for that corresponding PFI, the SGSN shall send a CREATE-BSS-PFC PDU to the BSS with a requested Aggregate BSS QoS Profile and start timer T7. On receipt of CREATE-BSS-PFC PDU the BSS stops timer T6 and responds with a CREATE-BSS-PFC-ACK PDU containing the negotiated Aggregate BSS QoS Profile. The BSS may restrict the requested ABQP given its capabilities and the current load. The SGSN may include the *Service UTRAN CCO* (Cell Change Order) information element in the PDU (relevant if the network initiated cell change order to UTRAN, network initiated cell change order to E-UTRAN, PS handover to UTRAN or PS Handover to E-UTRAN procedures are used). If this information element is received in multiple PDUs (either DL-UNITDATA PDU(s), CREATE-BSS-PFC PDU(s) or PS-HANDOVER-REQUEST PDU(s)), the information element contained in last received PDU shall take precedence. If there is an ongoing Delete PFC procedure the SGSN shall not send a CREATE-BSS-PFC-PDU (see subclause 8a.3).

The SGSN may also initiate the Create BSS PFC procedure. It is not required that the SGSN receive a DOWNLOAD-BSS-PFC PDU before sending a CREATE-BSS-PFC request.

The CREATE-BSS-PFC PDU may trigger a call admission control algorithm in the BSS to check whether the requested ABQP can be served. If there is valid MS Radio Access Capability IE known by the SGSN for the associated MS, the SGSN shall include it in the CREATE-BSS-PFC PDU. If the MS Radio Access Capability IE are not present in the request, then the Radio Access Capability Update procedure may be called.

The BSS may return a CREATE-BSS-PFC-NACK with a cause if it is unable to create or modify the PFC. On receipt of a CREATE-BSS-PFC-ACK PDU which does not convey the cause 'PFC queuing' (cf. sub-clause 8a.1.0a) or of a CREATE-BSS-PFC-NACK PDU the SGSN shall stop timer T7.

The Packet Flow Timer (PFT) is provided to the BSS by the SGSN. It is defined as the maximum time the BSS may hold the PFC during periods of inactivity for a PFC. The timer is started upon the receipt of a CREATE-BSS-PFC PDU and restarted after the transmission of an uplink PDU for that PFC. The timer is also restarted upon the transfer of the corresponding PFC from an old to a new cell.

If a CREATE-BSS-PFC PDU is received for an MS which has a BSS PFC in the BSS, then this shall be interpreted by the BSS as a request to:

- create a new PFC if the PFI included in the PDU is not known in the BSS,
- modify an existing PFC if the PFI included in the PDU is already known in the BSS.

The SGSN may inform the BSS about the contents of SPID in the CREATE-BSS-PFC PDU. In this case the SPID is stored in the BSS.

## 8a.1.0a Allocation/Retention Priority handling

The SGSN may include the *Allocation/Retention Priority* information element in the CREATE-BSS-PFC- PDU. If this information element is received and the BSS supports ARP handling, the BSS shall establish or modify the resources according to the values of the *Allocation/Retention Priority* IE (priority level, pre-emption indicators, queuing) and the resource situation as follows:

- The BSS shall consider the priority level of the requested PFC, when deciding on the resource allocation.
- If the requested PFC is allowed for queuing and the resource situation so requires, the BSS may place the PFC in the establishment queue.
- The priority levels and the pre-emption indicators may (singularly or in combination) be used to determine whether the PFC assignment has to be performed unconditionally and immediately. If the requested PFC is marked as "may trigger pre-emption" and the resource situation so requires, the BSS may trigger the pre-emption procedure which may then cause the forced release of a lower priority PFC which is marked as "pre-emptable". Whilst the process and the extent of the pre-emption procedure is operator dependent, the pre-emption indicators, if given in the CREATE-BSS-PFC PDU, shall be treated as follows:
  1. The values of the last received *Pre-emption Vulnerability* IE and *Priority Level* IE shall prevail.
  2. If the *Pre-emption Capability* IE is set to "may trigger pre-emption", then this allocation request may trigger the pre-emption procedure.
  3. If the *Pre-emption Capability* IE is set to "shall not trigger pre-emption", then this allocation request shall not trigger the pre-emption procedure.
  4. If the *Pre-emption Vulnerability* IE is set to "pre-emptable", then this connection shall be included in the pre-emption process.
  5. If the *Pre-emption Vulnerability* IE is set to "not pre-emptable", then this connection shall not be included in the pre-emption process.
  6. If the *Priority Level* IE is set to "no priority" the given values for the *Pre-emption Capability* IE and *Pre-emption Vulnerability* IE shall not be considered. Instead the values "shall not trigger pre-emption" and "not pre-emptable" shall prevail.
- If the *Allocation/Retention Priority* IE is not given in the CREATE-BSS-PFC -PDU, the allocation request shall not trigger the pre-emption process and the connection may be pre-empted and considered to have the value "lowest" as priority level. Moreover, queuing shall not be allowed.
- The BSS pre-emption process shall keep the following rules:
  1. The BSS shall only pre-empt PFCs with lower priority, in ascending order of priority.
  2. The pre-emption may be done for PFCs belonging to the same MS or to other MSs.

If the BSS is unable to create the PFC immediately and the ARP IE was present in the CREATE-BSS-PFC PDU indicating that queuing is allowed for the PFC, the BSS may put the PFC creation request or modification in a queue. In that case, it shall send a CREATE-BSS-PFC-ACK PDU including the cause 'PFC queuing' to the SGSN and start the timer T10. This timer specifies the maximum time for queuing of the request of establishment or modification; its value is provided by the SGSN in the CREATE-BSS-PFC PDU. Several PFCs for a given MS may be queued in parallel. While a PFC is queued, the BSS shall handle the corresponding uplink or downlink transfers according to a best-effort default aggregate BSS QoS profile.

For each PFC that is queued the following outcomes shall be possible:

- successfully established or modified;
- failed to establish or modify;
- failed due to expiry of the timer T10.

When the SGSN receives the response that the requested PFC is queued, the SGSN shall expect the BSS to provide the outcome of the queuing function for the PFC before expiry of T7. In case the timer T7 expires, the SGSN shall consider the create BSS PFC procedure terminated and failed.

The BSS shall report the outcome of the queuing for every queued PFC. The BSS shall stop the timer T10 associated to a given PFC when it has been successfully established or modified. The BSS shall then send a CREATE-BSS-PFC-ACK PDU with cause 'PFC created successfully' to the SGSN for that PFC, informing the SGSN of the negotiated ABQP. Upon receipt of the CREATE-BSS-PFC-ACK PDU with cause 'PFC created successfully' from the BSS, the SGSN shall stop timer T7.

In the case the timer T10 expires, the create BSS PFC procedure terminates in the BSS for the corresponding PFC and the BSS shall send a CREATE-BSS-PFC-NACK PDU with cause 'PFC create failure'. The SGSN shall then consider the create BSS PFC procedure terminated and failed.

In case the SGSN wishes to delete a PFC which is being queued, it shall stop timer T7 and start the delete BSS PFC procedure. Upon receipt of the request to delete the PFC, the BSS shall take it out from the queue and proceed with the rest of the procedure, as described in sub-clause 8a.3.

In case the SGSN wishes to modify a PFC which is being queued, it shall restart timer T7 and send a CREATE-BSS-PFC PDU as described in sub-clause 8a.1. Upon receipt of the request to modify the PFC, the BSS shall take it out from the queue and treat the new request.

### 8a.1.1 Abnormal conditions

If the SGSN receives a DOWNLOAD-BSS-PFC PDU with an unknown PFI it shall not respond with a CREATE-BSS-PFC PDU.

If a CREATE-BSS-PFC PDU is not received for a DOWNLOAD-BSS-PFC PDU within T6 seconds, then the DOWNLOAD-BSS-PFC PDU shall be repeated a maximum of DOWNLOAD-BSS-PFC-RETRIES attempts. After DOWNLOAD-BSS-PFC-RETRIES + 1 attempts the procedure is stopped and the O&M system is informed. If a BSS PFC is not received then the BSS shall handle uplink and downlink transfers according to a best-effort default aggregate BSS QoS profile.

If a CREATE-BSS-PFC-ACK or CREATE-BSS-PFC-NACK PDU is not received in response to a CREATE-BSS-PFC PDU within T7 seconds, then the CREATE-BSS-PFC PDU shall be repeated a maximum of CREATE-BSS-PFC-RETRIES attempts. After CREATE-BSS-PFC-RETRIES+1 attempts the procedure is stopped and the O&M is informed.

If a BSS not supporting ARP handling is unable to create the PFC then a CREATE-BSS-PFC-NACK PDU is returned with a cause value (e.g. Cause value: PFC create failure). The SGSN shall stop the Create BSS PFC procedure.

If a BSS supporting ARP handling is unable to create the PFC immediately and the ARP IE was not present in the CREATE-BSS-PFC PDU or the ARP IE was present but queuing is not allowed for the PFC, then a CREATE-BSS-PFC-NACK PDU is returned with cause value 'PFC create failure'. The SGSN shall then stop the Create BSS PFC procedure.

If a CREATE-BSS-PFC PDU is received in the BSS for an MS for which the PS Handover Required procedure is ongoing, the BSS shall ignore the CREATE-BSS-PFC PDU and return a CREATE-BSS-PFC-NACK PDU to the SGSN indicating Cause "MS under PS Handover treatment".

## 8a.2 Modify BSS PFC procedure

The BSS may request modification of the contents of an existing BSS PFC at any time via the MODIFY-BSS-PFC PDU, e.g. due to a change in resource availability at the BSS. The BSS sends the MODIFY-BSS-PFC PDU and start timer T8. The SGSN inserts the modified parameters in the MODIFY-BSS-PFC PDU into the relevant PDP contexts. The SGSN shall respond to a modify request with a MODIFY-BSS-PFC-ACK PDU except when there is an ongoing Delete BSS PFC procedure for that PFI (see sub-clause 8a.3). The SGSN may restrict the requested aggregate BSS QoS profile given its capabilities and current load. The Packet Flow Timer (PFT) may be provided to the BSS by the SGSN. This timer is (started or) restarted upon the receipt of the MODIFY-BSS-PFC-ACK PDU and restarted after the transmission of an uplink PDU for that PFC. On receipt of a response to the Modify procedure the BSS shall stop timer T8.

The SGSN can reject the profile proposed by the BSS by answering with a MODIFY-BSS-PFC-ACK PDU containing the previous ABQP. The SGSN may request the modification of the contents of a BSS PFC at any time via the CREATE-BSS-PFC PDU, e.g. due to the activation, modification, or deactivation of a PDP context. It shall not use the MODIFY-BSS-PFC PDU. If the BSS PFC already exists the BSS shall interpret the PDU as a modification request and

the BSS shall reply with a CREATE-BSS-PFC-ACK. The BSS may restrict the requested ABQP given its capabilities and the current load.

The Modify BSS PFC procedure shall never be initiated for an MS for which the PS Handover Required procedure is ongoing.

### 8a.2.1 Abnormal conditions

If a MODIFY-BSS-PFC-ACK is not received in response to a MODIFY-BSS-PFC PDU within T8 seconds, then the MODIFY-BSS-PFC PDU shall be repeated a maximum of MODIFY-BSS-PFC-RETRIES attempts. After MODIFY-BSS-PFC-RETRIES+1 attempts the procedure is stopped and the O&M is informed.

## 8a.3 Delete BSS PFC procedure

The SGSN may request the deletion of a BSS PFC at any time using the DELETE-BSS-PFC PDU. The BSS shall respond with a DELETE-BSS-PFC-ACK PDU. In case of user inactivity the BSS may delete a BSS packet flow context without notifying the SGSN. In case the BSS is no longer able to support the BSS PFC ABQP, it may send a DELETE-BSS-PFC-REQ PDU with cause "PFC pre-empted" or "ABQP no more supported" to the SGSN. The SGSN may either start the Delete BSS PFC procedure or a new Create BSS PFC procedure. In case the BSS receives neither a DELETE-BSS-PFC PDU nor a CREATE-BSS-PFC PDU the behaviour in the BSS is implementation specific.

The Delete BSS PFC procedure takes precedence over the Modify BSS PFC and the Create BSS PFC procedures, i.e. when the BSS receives a DELETE-BSS-PFC PDU it shall abort any ongoing Create BSS PFC or Modify BSS PFC procedure for that PFI.

If a DELETE-BSS-PFC PDU is received for an MS for which the PS Handover Required procedure is ongoing, the BSS shall initiate the PS Handover Cancel procedure and continue the Delete BSS PFC procedure for the corresponding MS.

## 8a.4 PS Handover Required procedure

In the case of an intra-BSS PS Handover or intra-BSS DTM Handover, the optimized intra-BSS handover procedure may be used (see 3GPP TS 44.060); in such case, the PS Handover Required procedure is not used.

When a BSS initiates a PS handover or DTM Handover it shall initiate the PS Handover Required procedure and send the PS-HANDOVER-REQUIRED PDU to the SGSN. Except in the case of DTM Handover, the BSS shall then start timer T12 (see NOTE).

NOTE: The DTM Handover procedure is guarded at the source BSS by the BSSMAP timer T23 (see 3GPP TS 48.008).

If DTM Handover is ongoing and was initiated for a reason specific to the packet resources, or PS Handover is ongoing, the *Cause* IE of the PS-HANDOVER-REQUIRED PDU should be set to an appropriate value (e.g. "Uplink quality", "Uplink strength", "Downlink quality", "Downlink strength", "Distance", "Better cell", "Traffic" or "O&M intervention").

NOTE: The radio related cause values are not applicable to the DTM Handover.

If DTM Handover is ongoing, and was initiated for a reason specific to the dedicated resource, the *Cause* IE shall indicate "CS cause".

The BSS should not initiate the PS handover required procedure in the case of an MOCN or a GWCN configuration if the Rerouting procedure is ongoing.

The BSS shall not initiate the PS handover required procedure in case CS to PS SRVCC from GERAN to UTRAN or to E-UTRAN [25] is ongoing. The reception of a PS-HANDOVER-REQUIRED PDU will initiate the PS Handover Required procedure in the SGSN and the allocation of resources in the target system.

If PS handover to A/Gb mode is required, the source BSS shall include the *Source BSS to Target BSS Transparent Container* IE and the *Target Cell Identifier* IE in the PS-HANDOVER-REQUIRED PDU.

If PS handover to Iu mode is required, the source BSS shall include the *Source to Target Transparent Container IE* and the *Target RNC Identifier IE* in the PS-HANDOVER-REQUIRED PDU. The *Source to Target Transparent Container IE* shall be encoded as the *Source RNC to Target RNC Transparent Container IE* as specified in 3GPP TS 25.413 or 3GPP TS 44.118.

If PS handover to a UTRAN CSG cell or hybrid cell is required, the source BSS shall include the *Source to Target Transparent Container IE*, *Target RNC Identifier IE* and the *CSG Identifier IE* in the PS-HANDOVER-REQUIRED PDU. The source BSS shall set the value of the *Cell Access Mode* field in the *CSG Identifier IE* according to the information received from the MS through measurement reporting as defined in 3GPP TS 44.060. The *Source to Target Transparent Container IE* shall be encoded as the *Source RNC to Target RNC Transparent Container IE* as specified in 3GPP TS 25.413.

NOTE: In this specification: A CSG cell is a reported cell for which the access mode indicates 'Closed access mode' as defined in [39] and Hybrid Cell is a reported cell for which the access mode indicates 'Hybrid access mode' as defined in [39].

If PS handover to E-UTRAN is required, the source BSS shall include the *Source to Target Transparent Container IE* and the *Target eNB Identifier IE* or the *Target RNC Identifier IE* (carrying the Corresponding RNC-ID of the target eNB) in the PS-HANDOVER-REQUIRED PDU. The *Source to Target Transparent Container IE* shall be encoded as the *Source eNB to Target eNB Transparent Container IE* as specified in 3GPP TS 36.413.

If PS handover to a E-UTRAN CSG cell or hybrid cell is required, the source BSS shall include the *Source to Target Transparent Container IE*, the *Target eNB Identifier IE*, *Tracking Area Code IE* and the *CSG Identifier IE* in the PS-HANDOVER-REQUIRED PDU. The source BSS shall set the value of the *Cell Access Mode* field in the *CSG Identifier IE* according to the information received from the MS through measurement reporting as defined in 3GPP TS 44.060. The *Source to Target Transparent Container IE* shall be encoded as the *Source eNB to Target eNB Transparent Container IE* as specified in 3GPP TS 36.413.

The *Active PFCs List IE* informs the SGSN about which PFCs that are active for the MS in the source cell at the time of sending the PS-HANDOVER-REQUIRED PDU. The concept of "Active PFCs" is defined in 3GPP TS 43.129. The *Active PFCs List IE* shall not contain any pre-defined PFIs.

For DTM Handover to A/Gb mode, the source BSS shall include the *CS Indication IE* in the *Source BSS to Target BSS Transparent Container IE*. The contents of the *CS Indication IE* shall uniquely identify, for this MS, the handover attempt, and shall be identical to the contents of the *PS Indication IE* included in the BSSMAP HANDOVER REQUIRED message (see 3GPP TS 48.008). The *Target Cell Identifier IE* shall identify the same cell as the one specified in the *Cell Identifier List (preferred) IE* in the corresponding BSSMAP HANDOVER REQUIRED message (see 3GPP TS 48.008).

For DTM Handover to UTRAN, the source BSS shall set the *Number of Iu Instances IE* equal to 2 in the *Source RNC to Target RNC Transparent Container IE* (see 3GPP TS 25.413)

When the resource allocation in the target system is complete, the SGSN shall send a PS-HANDOVER-REQUIRED-ACK PDU to the source BSS and end the PS Handover Required procedure.

The *Target BSS to Source BSS Transparent Container IE*, or the *Target to Source Transparent Container IE* as received from the target system, shall be included in the PS-HANDOVER-REQUIRED-ACK PDU.

Except in the case of DTM Handover, the source BSS shall, on reception of the PS-HANDOVER-REQUIRED-ACK PDU from the SGSN, stop timer T12, trigger the transmission of the PS HANDOVER COMMAND message towards the MS (as specified in 3GPP TS 44.060) and end the PS Handover Required procedure. In the case of DTM Handover, the PS Handover Required procedure is terminated when timer T23 is stopped for any reason or expires as specified in 3GPP TS 48.008. The subsequent behaviour of the network is specified in 3GPP TS 48.008.

In case of unsuccessful PS Handover, the source BSS shall be notified through the PS-HANDOVER-REQUIRED-NACK PDU.

When the SGSN terminates the PS Handover Required procedure by sending a PS-HANDOVER-REQUIRED-NACK PDU to the source BSS, the *Cause IE* should be set to an appropriate value (e.g. "PFC create failure", "Cell traffic congestion", "Equipment failure", "O&M intervention", "PS Handover Target not allowed" or "PS Handover not Supported in Target BSS or Target System").

Except in the case of DTM Handover, upon reception of a PS-HANDOVER-REQUIRED-NACK PDU from the SGSN, the source BSS shall stop timer T12 and terminate the ongoing PS Handover Required procedure.

For DTM Handover, the source BSS behaviour on receipt of a PS-HANDOVER-REQUIRED-NACK PDU is described as part of the Handover Required procedure (see 3GPP TS 48.008).

The source BSS shall always include the '*Reliable Inter RAT Handover Info*' indicator set to "1" in the PS-HANDOVER-REQUIRED-PDU when the target is a GERAN A/Gb mode BSS if the *Inter RAT Handover Info* IE is available and was received from the SGSN in a PS-HANDOVER-COMplete-ACK or a CREATE-BSS-PFC PDU or a PS-HANDOVER-REQUEST PDU with '*Reliable Inter RAT Handover Info Indicator*' set to '1'. It shall be set to "0" otherwise.

If the SGSN receives the *CSG Identifier* IE in the PS-HANDOVER-REQUIRED PDU and the *Cell Access Mode* field is set to 'CSG cell', it shall perform access control as specified in 3GPP TS 29.060. If the MS is allowed to access the target cell, the SGSN shall continue the PS handover to the target side as specified in 3GPP TS 29.060. If the MS is not allowed to access the target cell, the SGSN shall send the PS-HANDOVER-REQUIRED-NACK PDU with the *Cause* IE set to 'Invalid CSG cell' to the source BSS. If the *Cell Access Mode* field in the *CSG Identifier* IE is set to 'Hybrid cell', the SGSN shall provide the CSG membership status of the MS and the *CSG Id* to the target side as specified in 3GPP TS 29.060.

### 8a.4.1 Abnormal conditions

Except in the case of DTM Handover, if timer T12 expires in the source BSS and there has been no response from the SGSN to the PS-HANDOVER-REQUIRED PDU, the source BSS may initiate a new PS Handover Required procedure for the same mobile station, either directly or after first having cancelled the previous PS Handover Required procedure by initiating the PS Handover Cancel procedure with the value for the *Cause* IE set to "T12 expiry".

NOTE: For the case of DTM Handover, the abnormal condition caused by the expiry of BSSMAP timer T23 is described in 3GPP TS 48.008.

## 8a.5 PS Handover Request procedure

The SGSN shall initiate the PS Handover Request procedure by sending a PS-HANDOVER-REQUEST PDU, including the NAS container for PS Handover corresponding to the PFCs to be set-up (except in the case of intra-SGSN PS handover), to the target BSS and starting timer T13. The PS-HANDOVER-REQUEST PDU shall be sent on the point-to-point BVC indicated by the target Cell identity received from the old system.

On receipt of a PS-HANDOVER-REQUEST PDU containing a *CS Indication* IE (i.e. a DTM Handover procedure is ongoing), then the target BSS shall proceed as follows:

- If the timer T24 (see 3GPP TS 48.008) is not running, then the target BSS shall start timer T24.
- When both PS-HANDOVER-REQUEST PDU and BSSMAP HANDOVER REQUEST messages have been received and the contents of the *CS Indication* IE and *PS Indication* IE are identical, the target BSS shall stop timer T24 (see 3GPP TS 48.008), and, provided that a dedicated resource has been allocated (see 3GPP TS 48.008), attempt to create a new BSS Context for the MS, create PFCs according to the received ABQP parameters and allocate TBF resources within the capabilities of the mobile station.

On receipt of a PS-HANDOVER-REQUEST PDU which does not contain a *CS Indication* IE, the target BSS shall create a new BSS Context for the MS, create PFCs according to the received ABQP parameters and allocate TBFs for uplink and, if needed, for downlink transmission.

The SGSN may include the *Service UTRAN CCO* (Cell Change Order) information element in the PS-HANDOVER-REQUEST PDU (relevant if the network initiated cell change order to UTRAN, network initiated cell change order to E-UTRAN, PS handover to UTRAN or PS Handover to E-UTRAN procedures are used). If this information element is received in multiple PDUs (either DL-UNITDATA PDU(s), CREATE-BSS-PFC PDU(s) or PS-HANDOVER-REQUEST PDU(s)), the information element contained in the last received PDU shall take precedence.

The SGSN receiving the *Reliable Inter RAT Handover Info* IE in the PS-HANDOVER-REQUIRED PDU shall forward this IE to the target BSS in the PS-HANDOVER-REQUEST PDU.

The Packet Flow Timer (PFT) is provided to the target BSS by the SGSN for each corresponding PFC. It is defined as the maximum time the BSS may hold the PFC during periods of inactivity for a PFC. The timer is started upon the initiation of the PS Handover Complete procedure (see sub-clause 8a.7) and restarted after the transmission of an uplink PDU for that PFC. The timer is also restarted upon the transfer of the corresponding PFC from an old to a new cell.



When resources have been successfully allocated by the target BSS, it shall send a PS-HANDOVER-REQUEST-ACK PDU to the SGSN. From this point in time, the target BSS shall be prepared to receive downlink LLC PDUs for the corresponding MS on the allocated resources. The target BSS shall also be prepared to receive uplink RLC data blocks or a PS HANDOVER ACCESS message upon successful MS access in the target cell (as specified in 3GPP TS 44.060).

The PS-HANDOVER-REQUEST-ACK PDU shall include the *Target BSS to Source BSS Transparent Container IE* (see sub-clause 11.3.79) which contains either a complete PS HANDOVER COMMAND message or, in the case of DTM Handover, a complete DTM HANDOVER COMMAND message. For the definition of the PS HANDOVER COMMAND and DTM HANDOVER COMMAND messages, see 3GPP TS 44.060. In addition, the BSS shall include in the *Target BSS to Source BSS Transparent Container IE* the *SI/PSI Container IE* (see sub-clause 11.3.95b) if the *PS Handover Indications IE* indicating "SI/PSI requested" was present in the *Source BSS to Target BSS Transparent Container* of the incoming PS-HANDOVER-REQUEST PDU. In the case where the target cell supports network sharing and the MS Radio Access Capability information element included in the Source BSS to Target BSS Transparent Container received in the PS-HANDOVER-REQUEST PDU indicates MS supporting network sharing, the target BSS shall include in the SI/PSI messages sent to the source BSS (if included in the Target BSS to Source BSS Transparent Container) the same PLMN ID as the one received in the *Target Cell Identifier IE* in the PS-HANDOVER-REQUEST PDU.

Upon reception of the PS-HANDOVER-REQUEST-ACK PDU, the SGSN shall stop timer T13, end the PS Handover Request procedure and start timer T14 for supervision of the PS Handover Complete procedure.

The target BSS may choose to terminate the PS Handover Request procedure by sending a PS-HANDOVER-REQUEST-NACK PDU to the SGSN due to any of the following reasons:

- A BSS Context could not be allocated for the MS;
- None of the PFCs in the *PFCs To Be Set-up List IE* of the PS-HANDOVER-REQUEST PDU could be granted the requested QoS;
- No uplink TBF could be allocated for the MS in the BVCI.

In addition, the target BSS may choose to terminate the PS Handover Request procedure by sending a PS-HANDOVER-REQUEST-NACK PDU to the SGSN if at least one of the PFCs in the *PFCs To Be Set-up List IE* of the PS-HANDOVER-REQUEST PDU could not be granted the requested QoS and the *Cause IE* indicates a non-critical PS or DTM handover.

NOTE: The cause values "Better cell", "Traffic" indicate a non-critical PS or DTM handover.

When a PS-HANDOVER-REQUEST-NACK PDU has been sent, no knowledge of the MS should be kept by the target BSS.

Except in case of an attempted DTM Handover, when the target BSS decides to terminate the PS Handover Request procedure by sending a PS-HANDOVER-REQUEST-NACK PDU to the SGSN, the *Cause IE* should be set to an appropriate value (e.g. "PFC create failure", "Cell traffic congestion", "Equipment failure" or "O&M intervention").

In the case of an attempted DTM Handover, if the target BSS has failed to allocate PS resources, it shall send a PS-HANDOVER-REQUEST-NACK PDU with cause "DTM Handover - PS Allocation failure" to the SGSN. The target BSS may continue with the corresponding Handover Resource Allocation procedure, allocating only a dedicated resource (see 3GPP TS 48.008).

In the case of an attempted DTM Handover, if the target BSS does not allocate a CS resource, it shall not allocate any PS resources, and shall send a PS-HANDOVER-REQUEST-NACK PDU with cause "DTM Handover - No CS resource" to the SGSN.

The SGSN may inform the BSS about the contents of SPID in the PS-HANDOVER-REQUEST PDU. In this case the SPID is stored in the BSS.

## 8a.5.1 Abnormal conditions

If there is no response from the target BSS to the PS-HANDOVER-REQUEST PDU before timer T13 expires, the SGSN shall initiate the Delete BSS PFC procedure for each of the PFCs in the *PFCs to be Set-up List IE* for the corresponding MS.

If the timer T24 (see 3GPP TS 48.008) expires and the target BSS has received a PS-HANDOVER-REQUEST PDU (i.e. no corresponding BSSMAP HANDOVER REQUEST message has been received) the target BSS shall terminate the PS Handover Request procedure by sending a PS-HANDOVER-REQUEST-NACK PDU to the SGSN with cause "DTM Handover - T24 expiry".

If a PS-HANDOVER-REQUEST PDU is received which contains a *CS Indication* IE which corresponds to a DTM Handover attempt which was previously terminated for this MS, then the BSS shall terminate the PS Handover Request procedure by sending a PS-HANDOVER-REQUEST-NACK PDU to the SGSN with cause "DTM Handover - Invalid CS Indication IE". Any ongoing Handover Resource Allocation procedure (see 3GPP TS 48.008) for this mobile shall not be aborted in this case.

NOTE: Other failure cases related to the expiry of the A interface timer T24 are described in 3GPP TS 48.008).

If timer T14 expires before the SGSN receives a PS-HANDOVER-COMPLETE PDU, it shall initiate the Delete BSS PFC procedure for each allocated PFC (i.e. for each PFC included in the *List of Set-up PFCs* IE in the corresponding PS-HANDOVER-REQUEST-ACK PDU) towards the target BSS to release the resources allocated for all PFCs allocated for the MS.

## 8a.6 PS Handover Complete procedure

The target BSS shall initiate the PS Handover Complete procedure:

- in the case of PS Handover, on reception of the first correct RLC data block (sent in normal burst format as defined in 3GPP TS 44.060) from the MS in the target Cell;
- in the case of DTM Handover, on receipt of an RR HANDOVER COMPLETE message on the main DCCH in the target cell (see 3GPP TS 44.018).

The target BSS shall send a PS-HANDOVER-COMPLETE PDU to the SGSN.

From this point in time, the target BSS shall be prepared to receive uplink LLC PDUs from the corresponding MS on the allocated resources. Uplink LLC PDUs shall be sent from the target BSS to the SGSN with the TLLI received through the PS Handover Request procedure.

The target BSS supporting inter-RAT PS handover to UTRAN shall request the *Inter RAT Handover Info* IE from the SGSN upon successful PS handover completion in the following cases:

- PS handover from UTRAN to GERAN; in this case the BSS shall replace the *Inter RAT Handover Info* received from the source RNC with the new value received from the SGSN in the PS-HANDOVER-COMPLETE-ACK PDU.
- PS handover from GERAN *A/Gb mode* if it received PS-HANDOVER-REQUEST PDU with *Reliable Inter RAT Handover Info* IE missing or set to "0"; in this case the BSS shall replace the *Inter RAT Handover Info* received from the source BSS with the new value received from the SGSN in the PS-HANDOVER-COMPLETE-ACK PDU.
- PS handover from GERAN *A/Gb mode* if the "*INTER RAT HANDOVER INFO*" is missing in the *Source BSS to Target BSS Transparent Container* IE.
- PS handover from E-UTRAN if the "*INTER RAT HANDOVER INFO*" is missing in the *Source BSS to Target BSS Transparent Container* IE.

At reception of the PS-HANDOVER-COMPLETE PDU, the SGSN shall stop timer T14 (if running) and

- in case of non-optimised intra-BSS or intra-SGSN inter-BSS PS Handover, initiate the Delete BSS PFC procedure(s) towards the source BSS for each PFC corresponding to the MS in the source cell as described in sub-clause 8a.3; or
- in case of inter-SGSN PS Handover, send a Forward Relocation Complete message to the old SGSN (see 3GPP TS 29.060). The old SGSN shall initiate a Delete BSS PFC procedure for each PFC corresponding to the MS in the source cell towards the source BSS as described in sub-clause 8a.3.

## 8a.6.1 Abnormal conditions

If the SGSN does not receive a PS-HANDOVER-COMPLETE PDU before timer T14 expires, it shall initiate the Delete BSS PFC procedure towards the target BSS to release the resources for all PFCs allocated for the MS.

If a PS-HANDOVER-COMPLETE PDU refers to an MS which is unknown in the SGSN, it shall be ignored.

## 8a.7 PS Handover Cancel procedure

The source BSS may at any time, up to the time when the PS HANDOVER COMMAND or DTM HANDOVER COMMAND message is sent to the MS (as defined in 3GPP TS 44.060), initiate the PS Handover Cancel procedure. The reasons for cancellation could e.g. be "T12 expiry", "MS back on old channel", "Not all requested PFCs created" or "CS cause".

The source BSS shall initiate the PS Handover Cancel procedure if the cell change attempt fails and the MS returns to the old cell and sends either a PACKET CELL CHANGE FAILURE message as specified in 3GPP TS 44.060 (for PS Handover) or an RR HANDOVER FAILURE message as specified in 3GPP TS 44.018 (for DTM Handover) using the old radio resources.

During the normal intra-BSS or inter-BSS PS Handover, the source BSS shall also initiate the PS Handover Cancel procedure if it detects the loss of radio contact with MS (see 3GPP TS 44.060). The cause value in the PS-HANDOVER-CANCEL PDU shall be set to "Radio contact lost with MS". In the case of DTM Handover, the source BSS shall initiate the PS Handover Cancel procedure in the following additional cases defined in the list of Abnormal Cases for the Handover Required Indication procedure (see 3GPP TS 48.008):

- a) Timer T23 expires and the source BSS has received a PS-HANDOVER-REQUIRED-ACK PDU from the SGSN;
- b) The source BSS receives a PS-HANDOVER-REQUIRED-ACK PDU and a BSSMAP HANDOVER REQUIRED REJECT message (see 3GPP TS 48.008);
- c) If the DTM Handover is ongoing and T8 expires (see 3GPP TS 48.008).

The cause value in the PS-HANDOVER-CANCEL PDU shall be set to:

- in case a) above: "DTM Handover - T23 expiry";
- in case b) above: "DTM Handover - MSC error";
- in case c) above: "Radio contact lost with MS".

When the source BSS decides to cancel an ongoing PS handover or DTM Handover, it shall initiate the PS Handover Cancel procedure by sending a PS-HANDOVER-CANCEL PDU to the SGSN. The source BSS shall regard all procedures related to PS handover or DTM Handover for the given MS as terminated after having sent the PS-HANDOVER-CANCEL PDU to the SGSN.

Upon reception of a PS-HANDOVER-CANCEL PDU, (in the case of Inter-SGSN PS handover or Inter-SGSN DTM handover) the SGSN shall initiate a Forward Relocation Cancel procedure according to 3GPP TS 29.060.

Upon reception of a PS-HANDOVER-CANCEL PDU, (in the case of Intra-SGSN PS handover or Intra-SGSN DTM handover or Inter-RAT PS handover) the SGSN shall

- in case of GERAN *A/Gb mode* to GERAN *A/Gb mode* PS/DTM handover, initiate the Delete BSS PFC procedure towards the target BSS to release the resource allocated for the MS.
- in case of GERAN *A/Gb mode* to UTRAN PS/DTM handover, initiate the Iu Release procedure towards the target RNC to release the resource allocated for the UE (see 3GPP TS 25.413).
- in case of GERAN *A/Gb mode* to E-UTRAN PS handover, initiate the Relocation Cancel procedure towards target MME which initiates the release of the resources allocated for the UE by the target eNB (see 3GPP TS 36.413).

NOTE: In case of cancellation due to CS call establishment, current behaviour regarding possible suspension of GPRS services applies after the PS Handover Cancel procedure is completed.

## 8a.7.1 Abnormal conditions

If a PS-HANDOVER-CANCEL PDU refers to an MS/UE which is unknown in the SGSN, it shall be ignored.

An SGSN shall ignore a PS-HANDOVER-CANCEL PDU which refers to an MS for which the SGSN has already received a PS-HANDOVER-COMplete PDU from the target BSS (in the case of intra-SGSN PS handover) or a FORWARD RELOCATION COMPLETE message from the new SGSN (in the case of inter-SGSN PS handover).

---

# 8b Signalling Procedures between LCS SAPs

## 8b.1 Location Procedure

When the SGSN receives a location request, and the BSS supports LCS, the SGSN starts the location procedure by sending a PERFORM-LOCATION-REQUEST PDU.

The SGSN shall provide the BVCI and the NSEI indicating the PTP functional entity (i.e. the cell) upon which the last LLC-PDU was received from the MS as well as the Cell ID received together with that LLC-PDU. The SGSN shall also provide the IMSI. If the SGSN has valid DRX Parameters for a TLLI, then the SGSN shall include them in the PDU. If the SGSN has valid eDRX Parameters for a TLLI, then the SGSN shall include them in the PDU. The SGSN shall also provide the downlink Coverage Class associated with the MS, if previously received from the BSS in the UL-UNITDATA PDU.

If MS Radio Access Capability information is available in the SGSN for the associated MS, the SGSN shall include it in the PERFORM-LOCATION-REQUEST PDU.

The Location Type indicates which type of location information the SGSN is requesting. The LCS capability IE reports the PS LCS capabilities of the MS and is included by the SGSN if it has been received from the MS. LCS Priority and LCS QoS are provided if available in the SGSN. The SGSN may provide the IMEI of the Mobile Station.

On receipt of the PERFORM-LOCATION-REQUEST PDU for positioning of the target MS, the BSS transfers the positioning request to the SMLC according to the procedures defined in 3GPP TS 43.059 and 3GPP TS 49.031 and awaits the result. The BSS then returns the result of positioning to the SGSN in the PERFORM-LOCATION-RESPONSE PDU. This PDU contains the PTP BVCI indicating the PTP functional entity (i.e. the cell) upon which the last LLC-PDU was received from the MS, a location estimate and optionally positioning data.

If assistance data was instead requested by the SGSN for an MS, the BSS transfers the request to the SMLC according to the procedures defined in 3GPP TS 43.059 and 3GPP TS 49.031 and awaits the result. If the Requested GPS or GANSS Assistance Data IE was received from the MS, it is forwarded to the BSS. If the SMLC indicates to the BSS that it was able successfully to transfer this to the MS, the BSS shall return a PERFORM-LOCATION-RESPONSE PDU to the SGSN. This PDU shall contain the PTP BVCI indicating the PTP functional entity (i.e. the cell) upon which the last LLC-PDU was received from the MS but no other optional or conditional information elements. The absence of an LCS Cause parameter in this case implies that the transfer was successful.

Otherwise, if the deciphering keys were requested for LCS broadcast assistance data, the BSS transfers the request to the SMLC according to the procedures defined in 3GPP TS 43.059 and 3GPP TS 49.031 and awaits the result. If the BSS receives the deciphering keys, the BSS shall send them to the SGSN in a PERFORM-LOCATION-RESPONSE PDU containing also the PTP BVCI indicating the PTP functional entity (i.e. the cell) upon which the last LLC-PDU was received from the MS.

### 8b.1.1 Unsuccessful Operation

If the BSS fails to respond to the PERFORM-LOCATION-REQUEST PDU it returns a PERFORM-LOCATION-RESPONSE PDU with a LCS cause value indicating the failure cause.

If the BSS receives a failure indication from the SMLC it shall send a PERFORM-LOCATION-RESPONSE PDU to the SGSN with the LCS cause value that it received from the SMLC.

## 8b.1.2 Abnormal Conditions

The following condition may occur:

If the SGSN needs to abort previously initiated location request, it shall send the PERFORM-LOCATION-ABORT PDU to the BSS. This PDU shall include the PTP BVCI indicating the PTP functional entity (i.e. the cell) upon which the last LLC-PDU was received from the MS. As a result of reception of this PDU the BSS shall abort activities related to positioning of the target MS or assistance data delivery. The BSS shall return a PERFORM-LOCATION-RESPONSE PDU with a cause value indicating the abortion of location request. The SGSN may reattempt the positioning request after the PERFORM-LOCATION-RESPONSE PDU is received from the BSS, but not before the PDU is received.

If the P-TMSI is reallocated for a target MS during the location procedure, the SGSN shall abort the location procedure.

If a SUSPEND PDU is received for a target MS during the location procedure, the SGSN shall abort the location procedure.

If a Routing Area Update request is received from a target MS during the location procedure, the SGSN shall abort the location procedure.

If an Inter NSE Cell Change, within the same routing area, occurs for a target MS during the location procedure, the SGSN shall provide the new NSEI and new BVCI in the FLUSH-LL PDU sent to the BSS, in order for the BSS to maintain the on-going location procedure, if possible. In case the BSS is unable to maintain the on-going location procedure, then a location abort shall be triggered by the BSS towards the SMLC.

## 8b.1.3 Overload

For location requests initiated by the SGSN, the BSC may employ the same procedures defined for an SMLC in 3GPP TS 49.031 to alleviate an overload condition in the BSS.

## 8b.2 Position Command Procedure

The position command procedure is used to convey an embedded RRLP message between the BSS and the MS.

### 8b.2.1 Position Command

The BSS initiates the position command procedure by sending the POSITION-COMMAND PDU to the SGSN. The procedure is only valid while a location procedure for the target MS is ongoing.

The POSITION-COMMAND PDU shall include the RRLP Flags and the RRLP APDU information elements and the PTP BVCI indicating the PTP functional entity (i.e. the cell) upon which the last LLC-PDU was received from the MS. The RRLP APDU information element carries the RRLP message and the RRLP Flags information element carries control information for RRLP.

The SGSN shall extract the RRLP message from the RRLP APDU information element and forward it, together with the RRLP Flags, to the MS in a TOM message carried in an LLC-PDU, see 3GPP TS 44.064.

### 8b.2.2 Position Response

The SGSN initiates the position response procedure when it receives a TOM message in an LLC-PDU carrying an RRLP message for a target MS. The procedure is only valid while a location procedure for the target MS is ongoing.

When the SGSN receives a TOM message in an LLC-PDU carrying an RRLP message for a target MS, the SGSN shall extract the RRLP message and forward it to the BSS in a POSITION-RESPONSE PDU. The RRLP message shall be included in the RRLP APDU information element. The RRLP Flags information shall be extracted from the TOM header and be included in the RRLP Flags information element. The POSITION-RESPONSE PDU shall also include the PTP BVCI indicating the PTP functional entity (i.e. the cell) upon which the last LLC-PDU was received from the MS.

## 8b.2.3 Unsuccessful Operation

If the SGSN fails to process the POSITION-COMMAND PDU it returns a POSITION-RESPONSE PDU with a LCS cause value indicating the failure cause.

If a POSITION-COMMAND PDU is received by the SGSN while a location procedure for the target MS is not ongoing a POSITION-RESPONSE PDU with a LCS cause value indicating this failure cause is returned.

If a POSITION-RESPONSE PDU is received by the BSS while a location procedure for the target MS is not ongoing the BSS shall ignore the PDU.

---

# 8c Signalling procedures between RIM SAPs

## 8c.1 General

### 8c.1.1 Introduction

The following sub-clauses describe the generic RAN Information Management (RIM) procedures which support the exchange of information, via the core network, between peer application entities located in a GERAN, in a UTRAN, in an E-UTRAN or in an eHRPD evolved access network.

The RIM function is performed through the interaction of the following sub-layers:

- the underlying part of BSSGP used to transport and route the RIM PDUs from a BSS to an SGSN or from an SGSN to a BSS over the Gb interface;
- the RIM protocol allowing the exchange of the information between two BSSs or between a BSS and an RNS or between a BSS and an eNodeB or between an eNodeB and an eHRPD eAN transparently through the core network;
- the application part on the top of the RIM protocol, referred to as the "RIM application" in this specification.

NOTE: The functional split between the RIM application and the RIM protocol is provided for information in the present specification and should allow for various implementations.

The PDUs conveying the RAN information between two RIM entities are including containers that shall not be interpreted by the core network nodes. The exchange of information is triggered by the application in a controlling BSS.

The support of different applications is achieved by the appropriate definition of specific application containers for those applications.

If the RAN Information Management (RIM) feature is supported by both the BSS and the SGSN, the RIM procedures can be used by any RIM application running on this BSS and requiring information transfer between two BSSs via the core network.

NOTE: Specific requirements applicable to RIM between GERAN and UTRAN or between GERAN and E-UTRAN and between E-UTRAN and eHRPD eAN are specified in sub-clause 8c.1.4.

### 8c.1.2 Definitions

#### 8c.1.2.1 Controlling and serving nodes

The BSS requesting the information is called the "controlling BSS", the BSS providing the requested information is called the "serving BSS". Considering a pair of BSSs, each may be at the same time both a controlling BSS and a serving BSS.

In the present specification the term "BSS" should be understood as "RNC, eNodeB or eAN" in the relevant situations (e. g. NACC from UTRAN/E-UTRAN to GERAN), unless it is explicitly stated otherwise.

### 8c.1.2.2 RIM association

A RIM association links unambiguously either a cell in the serving BSS with the controlling BSS that has initiated an information request related to that cell for a given application, or a cell in the controlling BSS with the serving BSS that receives the RAN-INFORMATION-REQUEST PDU for a given application, and is identified by the following pieces of information:

- Controlling BSS identifier, or, for some particular values of the SON Transfer Application Identity for which the Reporting Cell Identifier is a cell in the controlling BSS (see TS 36.413 [36]), the serving BSS identifier.
- Cell Identifier in the serving BSS, or, for some particular values of the SON Transfer Application Identity (see TS 36.413 [36]), Cell Identifier in the controlling BSS.
- RIM Application Identity
- SON Transfer Application Identity (only applicable if the RIM Application Identity indicates "SON Transfer").

### 8c.1.2.3 RIM variables

In this protocol description, variables are used to represent the status of the relevant entity as a result of an event, such as the reception of an information element in a message. The variables serve the purpose of specifying an abstract model of the protocol entity, and do not therefore impose any particular implementation.

The following variables are defined in the serving BSS:

- **MULTIPLE\_REPORTING\_ONGOING**: this variable indicates whether event-based multiple reporting is active or not for a given RIM association. This variable is initialised to **FALSE** prior to the reception of any request related to the corresponding association from the controlling BSS, then it is updated according to the relevant procedure requirements.
- **MULTIPLE\_REPORT\_SETTING\_RSN**: this variable stores the RSN of the last request having initiated or re-initiated multiple reporting in the serving BSS and is used as a reference to ascertain whether any further request received for this association is outdated or not. The value of this variable is only significant when multiple reporting is active (i.e. **MULTIPLE\_REPORTING\_ONGOING** set to **TRUE**).

## 8c.1.3 RIM PDUs description

### 8c.1.3.1 RAN-INFORMATION-REQUEST PDU

The RAN-INFORMATION-REQUEST PDU is used by the controlling BSS to request or interrupt an information transfer from a serving BSS. The RAN-INFORMATION-REQUEST PDU specifies the requested operation and the expected information when applicable. The following RAN-INFORMATION-REQUEST PDU type extensions are defined:

- RAN-INFORMATION-REQUEST/Single Report is used to request a single report.
- RAN-INFORMATION-REQUEST/Multiple Report is used to request event-driven multiple reports.
- RAN-INFORMATION-REQUEST/Stop is used to stop event-driven multiple reports.

### 8c.1.3.2 RAN-INFORMATION PDU

The RAN-INFORMATION PDU is used by the serving BSS to transmit the requested information to the controlling BSS. The following RAN-INFORMATION PDU type extensions are defined:

- RAN-INFORMATION/Single Report is used to acknowledge the reception of a RAN-INFORMATION-REQUEST/Single Report and to transmit the requested single report information.
- RAN-INFORMATION/Initial Multiple Report is used to acknowledge the reception of a RAN-INFORMATION-REQUEST/Multiple Report and to transmit the initial report of the event-driven multiple reporting.

- RAN-INFORMATION/Multiple Report is used to transmit subsequent reports while event-driven multiple reporting is active.
- RAN-INFORMATION/Stop is used to acknowledge the reception of a RAN-INFORMATION-REQUEST/Stop.
- RAN-INFORMATION/End is used to indicate that the serving BSS will not longer send multiple reports for other reasons than the reception of a RAN-INFORMATION-REQUEST/Stop.

### 8c.1.3.3 RAN-INFORMATION-ACK PDU

The RAN-INFORMATION-ACK PDU is used by the controlling BSS to acknowledge the reception of a previous RAN-INFORMATION PDU if so requested by the serving BSS and is used by the serving BSS to acknowledge the reception of a previous RAN-INFORMATION-APPLICATION-ERROR PDU if so requested by the controlling BSS.

### 8c.1.3.4 RAN-INFORMATION-ERROR PDU

The RAN-INFORMATION-ERROR PDU is used, by either the controlling or the serving BSS, to report an error diagnosed at the RIM protocol level to the peer entity.

### 8c.1.3.5 RAN-INFORMATION-APPLICATION-ERROR PDU

The RAN-INFORMATION-APPLICATION-ERROR PDU is used by the controlling BSS to inform the peer application in the serving BSS about erroneous application information in a previously received RAN-INFORMATION PDU.

## 8c.1.4 RIM addressing and routing principles

### 8c.1.4.1 RIM routing address

#### 8c.1.4.1.1 GERAN BSS identification

As there is no BSS address identifier defined as such in the 3GPP specifications, RIM makes use of the cell identifier (RAI + CI - see sub-clause 11.3.9 in the present document and 3GPP TS 23.003) of any cell parented by the BSS:

- the cell identifier of the source cell is used to identify the BSS issuing a RIM PDU;
- the cell identifier of the destination cell is used to identify the BSS towards which a RIM PDU is issued.

The source cell identifying the BSS issuing a RAN-INFORMATION-REQUEST PDU may be chosen arbitrarily within all the cells parented by the controlling BSS. The deletion or the re-parenting of any cell used as a source cell in the controlling BSS shall trigger the actions described in sub-clause 8c.5.2.

#### 8c.1.4.1.2 UTRAN RNS identification

When RIM is used to support the exchange of information with a peer application entity located in UTRAN, the RNC identifier (see sub-clause 11.3.70) shall be used as the RIM Routing Address (Source Cell Identifier or Destination Cell Identifier) to identify the corresponding RNS.

#### 8c.1.4.1.3 E-UTRAN eNodeB identification

When RIM is used to support the exchange of information with a peer application entity located in E-UTRAN, an eNB identifier (see sub-clause 11.3.70) shall be used as the RIM Routing Address (Source Cell Identifier or Destination Cell Identifier) to identify the corresponding eNodeB.

#### 8c.1.4.1.4 eHRPD eAN identification

When RIM is used to support the exchange of information with a peer application entity located in eHRPD, an *eHRPD Sector ID* IE (see sub-clause 11.3.70) shall be used as the RIM Routing Address (Source Cell Identifier or Destination Cell Identifier) to identify the corresponding eHRPD eAN.



#### 8c.1.4.2 Routing via the core network

The RIM PDUs shall be conveyed transparently by the core network toward the destination BSS, RNS, eNodeB or eHRPD eAN. A SGSN or MME shall use the destination address included in each RIM PDU either to send the PDU to the relevant BSS, RNS, eNodeB or eAN through the Gb, the Iu, the S1 or the S121 interface respectively, or to tunnel the PDU towards the target SGSN or MME parenting the destination node through the Gn or S3 interface respectively.

If a RIM PDU has been tunnelled through the Gn or S3 interface to a destination SGSN or MME that does not support RIM the PDU is discarded without further action.

#### 8c.1.4.3 Address mirroring

The following address mirroring principles shall be applied:

- the serving BSS shall mirror the *Source Cell Identifier* IE value and the *Destination Cell Identifier* IE value of the received RAN-INFORMATION-REQUEST PDU into the *Destination Cell Identifier* IE and the *Source Cell Identifier* IE, respectively, of the related RAN-INFORMATION PDU(s);
- the controlling BSS shall mirror the *Source Cell Identifier* IE value and the *Destination Cell Identifier* IE value of the RAN-INFORMATION PDU to be acknowledged into the *Destination Cell Identifier* IE and the *Source Cell Identifier* IE, respectively, of the related RAN-INFORMATION-ACK PDU;
- the BSS having identified an error at the RIM protocol level in a received RAN-INFORMATION-REQUEST PDU, RAN-INFORMATION PDU, RAN-INFORMATION-ACK PDU or RAN-INFORMATION-APPLICATION-ERROR PDU shall mirror the *Source Cell Identifier* IE value and the *Destination Cell Identifier* IE value of the erroneous PDU into the *Destination Cell Identifier* IE and the *Source Cell Identifier* IE, respectively, of the RAN-INFORMATION-ERROR PDU;
- the controlling BSS having identified an error at application level in a received PDU shall mirror the *Source Cell Identifier* IE value and the *Destination Cell Identifier* IE value of the RAN-INFORMATION PDU which carried the erroneous application information into the *Destination Cell Identifier* IE and the *Source Cell Identifier* IE, respectively, of the RAN-INFORMATION-APPLICATION-ERROR PDU.

### 8c.1.5 In-order delivery and reliable transfer - RSN

#### 8c.1.5.1 General

A BSS shall allocate a RIM Sequence Number (RSN) to any RAN-INFORMATION-REQUEST PDU, RAN-INFORMATION PDU or RAN-INFORMATION-APPLICATION-ERROR PDU sent by this BSS. The purpose of the RSN is twofold:

- to assess whether a RAN-INFORMATION-REQUEST PDU or a RAN-INFORMATION PDU received for a given RIM association is providing up-to-date information or is outdated if having been overtaken by a PDU received previously;
- to identify the PDU acknowledged with a RAN-INFORMATION-ACK PDU or reported in a RAN-INFORMATION-ERROR PDU.

For the purpose of comparing any RSN value to a given RSN X, the RSN numbering space is halved in two equal parts (see figure 8c.1) located on either sides of RSN X, the half part "below" RSN X (modulo RSN MAX+1) defining the RSN values "older" than RSN X, the half part "above" (modulo RSN MAX+1) RSN X defining the RSN values "newer" than RSN X.

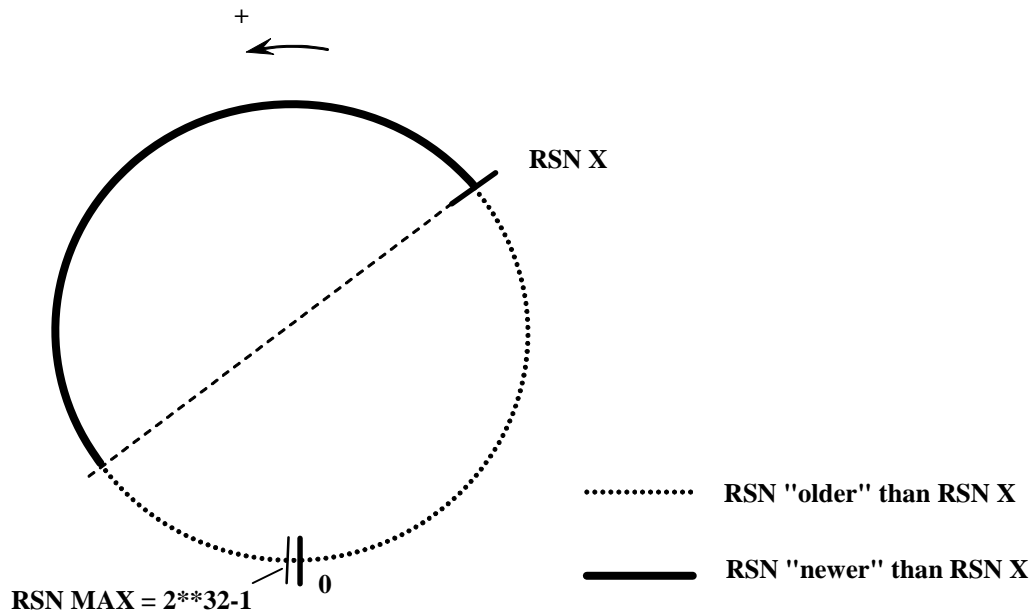

Figure 8c.1: Comparing RSN values

### 8c.1.5.2 Allocating RSN values at the sending BSS

The RSN allocated to a RAN-INFORMATION-REQUEST PDU, RAN-INFORMATION PDU or RAN-INFORMATION-APPLICATION-ERROR PDU shall be greater (modulo  $2^{**}32$ ) than the RSN value allocated to the previous PDU of the same type sent for this association. In case a given PDU needs to be resent, this PDU may be re-issued with either the same RSN value or an increased RSN value (modulo  $2^{**}32$ ).

NOTE: The RSN values allocated to two different PDUs sent successively for a given RIM association need not be consecutive (e.g. the RSN values could be uniquely allocated for a given application or within the whole BSS). However, in order to avoid RSN values depletion, the sending BSS should allocate the next higher RSN value (modulo  $2^{**}32$ ) to the next PDU to be sent.

To allow a receiving entity to assess whether two PDUs are received in the same relative order they have been sent or not, the difference between the RSN values allocated to those two PDUs should not exceed an RSN window size of  $2^{**}31$  (see sub-clause 8c.1.5.3).

NOTE: In order to cope with RSN values outside the RSN window for a given RIM association, the relevant RIM procedures might be triggered on a timely basis for advancing the RSN window.

### 8c.1.5.3 Comparing RSN values at the receiving BSS

Let PDU1 and PDU2 be two PDUs received at the BSS and related to the same RIM association, PDU1 is considered as having been sent earlier than PDU2 if the difference between the associated RSNs is less than an RSN window size of  $2^{**}31$  (see sub-clause 8c.1.5.2), i.e.:

$$(\text{RSN2} - \text{RSN1}) \bmod (2^{**}32) < 2^{**}31$$

## 8c.1.6 RIM Protocol Version Number

The *RIM Protocol Version Number* Information Element may be included in a RIM PDU. The *RIM Protocol Version Number* IE indicates which version of the RIM protocol is in use in the BSS having issued the PDU. If this Information Element is omitted, the behaviour of the receiving BSS should be the same as if the value of the *RIM Protocol Version Number* IE was "Version 1".

Only "Version 1" is defined in the present version of the specification.

In case the protocol version of the receiving BSS is lower than the version of the sending BSS, and unless otherwise specified in the present specification, the general rules of the BSSGP protocol apply and any unknown parameter shall be ignored.

## 8c.2 RIM procedures

### 8c.2.1 General

The RAN Information Request procedure is initiated by an application in the controlling BSS when it either requires information or wants to stop the transmission of information from a remote peer entity of the same application in the serving BSS. The application on the controlling side indicates the type of operation (Multiple Reports, Single Report, Stop) to the peer entity.

The RAN Information Send procedure is used to transfer application information between two entities of the same application in two BSSs via the core network.

The RAN Information Application Error procedure is initiated by an application in the controlling BSS to transfer application error information to the peer application entity of the same application in the serving BSS.

The RAN Information Error procedure is initiated by the RIM entity in the controlling or the serving BSS to transfer error information to the RIM entity in the peer BSS.

### 8c.2.2 RAN Information Request procedure

#### 8c.2.2.1 RAN Information Request/Single Report procedure

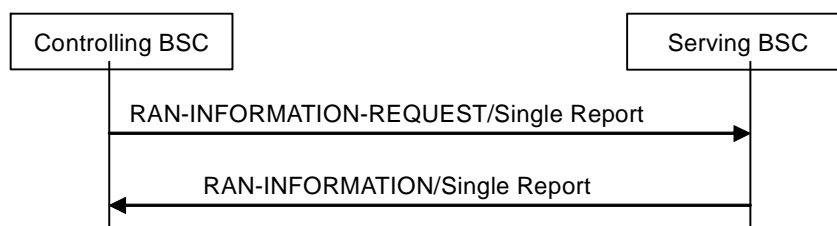

**Figure 8c.2.2.1: RAN Information Request/Single Report Procedure**

##### 8c.2.2.1.1 Initiation by the controlling BSS

Upon initiation of the procedure, the controlling BSS shall:

- 1> set the content of the RAN-INFORMATION-REQUEST/Single Report PDU as follows:
  - 2> set the *PDU type* IE, the *Destination Cell Identifier* IE and the *Source Cell Identifier* IE;
  - 2> set the content of the *RIM Container* IE as follows:
    - 3> set the *RIM Application Identity* IE and the *RIM Sequence Number* IE;
    - 3> set the *PDU Type Extension* field in the *RIM PDU Indications* IE to "RAN-INFORMATION-REQUEST/Single Report";
    - 3> set the *RIM Protocol Version Number* IE if necessary (see sub-clause 8c.1.6);
    - 3> include the *Application Container* IE according to the requirements of the application;
- 1> send the RAN-INFORMATION-REQUEST/Single Report PDU;
- 1> start T(RIR);

### 8c.2.2.1.2 Reception of a valid RAN-INFORMATION-REQUEST/Single Report PDU by the serving BSS

Upon reception of a valid RAN-INFORMATION-REQUEST/Single Report PDU as defined in sub-clause 8c.3.2 the serving BSS shall:

- 1> set the content of the RAN-INFORMATION/Single Report PDU as follows:
  - 2> set the *PDU type* IE; mirror the *Source Cell Identifier* IE value and the *Destination Cell Identifier* IE value of the RAN-INFORMATION-REQUEST/Single Report PDU respectively into the *Destination Cell Identifier* IE and the *Source Cell Identifier* IE of the RAN-INFORMATION/Single Report PDU;
  - 2> set the content of the *RIM Container* IE as follows:
    - 3> set the *RIM Application Identity* IE as required by the application;
    - 3> set the *RIM Sequence Number* IE and, if necessary, the *RIM Protocol Version Number* IE (see sub-clause 8c.1.6);
    - 3> set the *ACK* indicator in the *RIM PDU Indications* IE to "No ACK requested";
    - 3> set the *PDU Type Extension* field in the *RIM PDU Indications* IE to "RAN-INFORMATION/Single Report";
    - 3> include either the *RAN-INFORMATION Application Container* IE or the *Application Error Container* IE according to the requirements of the application;
- 1> send the RAN-INFORMATION/Single Report PDU to the controlling BSS.

### 8c.2.2.1.3 Reception of a valid RAN-INFORMATION/Single Report PDU by the controlling BSS

Upon reception of a valid RAN-INFORMATION/Single Report PDU as defined in sub-clause 8c.3.2 the controlling BSS shall:

- 1> stop T(RIR) for this RIM association;
- 1> deliver the relevant information to the application;

and the procedure ends.

### 8c.2.2.1.4 Expiration of T(RIR) in the controlling BSS

If T(RIR) expires the controlling BSS shall as an implementation option either inform the application that the procedure has failed or restart the RAN Information Request/Single Report procedure a finite number of times as described in sub-clause 8c.2.2.1.1.

### 8c.2.2.2 RAN Information Request/Multiple Report procedure

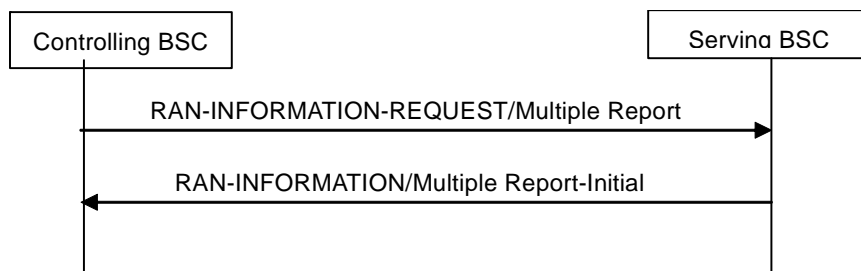

**Figure 8c.2.2.2: Successful RAN Information Request/Multiple Report Procedure**

#### 8c.2.2.2.1 Initiation by the controlling BSS

Upon initiation of the procedure, the controlling BSS shall:

- 1> set the content of the RAN-INFORMATION-REQUEST/Multiple Report PDU as follows:
  - 2> set the *PDU type* IE, the *Destination Cell Identifier* IE and the *Source Cell Identifier* IE;
  - 2> set the content of the *RIM Container* IE as follows:
    - 3> set the *RIM Application Identity* IE and the *RIM Sequence Number* IE;
    - 3> set the *PDU Type Extension* field in the *RIM PDU Indications* IE to "RAN-INFORMATION-REQUEST/Multiple Report";
    - 3> set the *RIM Protocol Version Number* IE if necessary (see sub-clause 8c.1.6);
    - 3> include the *Application Container* IE according to the requirements of the application;
- 1> send the RAN-INFORMATION-REQUEST/Multiple Report PDU;
- 1> Start T(RIR);

#### 8c.2.2.2.2 Reception of a valid RAN-INFORMATION-REQUEST/Multiple Report PDU by the serving BSS

Upon reception of a valid RAN-INFORMATION-REQUEST/Multiple Report PDU as defined in sub-clauses 8c.3.2 the serving BSS shall:

- 1> if `MULTIPLE_REPORTING_ONGOING` is set to TRUE for this RIM association and if the received RAN-INFORMATION-REQUEST/Multiple Report PDU is considered as having been sent earlier (see sub-clause 8c.1.5) than the PDU whose RSN is stored in `MULTIPLE_REPORT_SETTING_RSN`, then:
  - 2> discard the PDU without further actions and the procedure ends;
- 1> otherwise:
  - 2> set the `MULTIPLE_REPORTING_ONGOING` variable to TRUE for this RIM association;
  - 2> store the *RIM Sequence Number* IE value of the received PDU in the `MULTIPLE_REPORT_SETTING_RSN` variable;
  - 2> set the content of the RAN-INFORMATION/Initial Multiple Report PDU as follows:
    - 3> set the *PDU type* IE; mirror the *Source Cell Identifier* IE value and the *Destination Cell Identifier* IE value of the RAN-INFORMATION-REQUEST/Multiple Report PDU respectively into the *Destination Cell Identifier* IE and the *Source Cell Identifier* IE of the RAN-INFORMATION/Initial Multiple Report PDU;
    - 3> set the content of the *RIM Container* IE as follows:
      - 4> set the *RIM Application Identity* IE as required by the application;
      - 4> set the *RIM Sequence Number* IE and, if necessary, the *RIM Protocol Version Number* IE (see sub-clause 8c.1.6);
      - 4> set the *ACK* indicator in the *RIM PDU Indications* IE to "No ACK requested";
      - 4> set the *PDU Type Extension* field in the *RIM PDU Indications* IE to "RAN-INFORMATION/Initial Multiple Report";
      - 4> include either the RAN-INFORMATION *Application Container* IE or the *Application Error Container* IE according to the requirements of the application;
  - 2> send the RAN-INFORMATION/Initial Multiple Report PDU.

### 8c.2.2.2.3 Reception of a valid RAN-INFORMATION PDU/Initial Multiple Report PDU by the controlling BSS

Upon reception of a valid RAN-INFORMATION/Initial Multiple Report PDU as defined in sub-clause 8c.3.2 the controlling BSS shall:

- 1> stop T(RIR) for this RIM association;
- 1> deliver the relevant information to the application;

and the procedure ends.

### 8c.2.2.2.4 Expiration of T(RIR) in the controlling BSS

If T(RIR) expires the controlling BSS shall as an implementation option either inform the application that the procedure has failed or restart the RAN Information Request/Multiple Report procedure a finite number of times as described in sub-clause 8c.2.2.2.1.

### 8c.2.2.3 RAN Information Request/Stop procedure

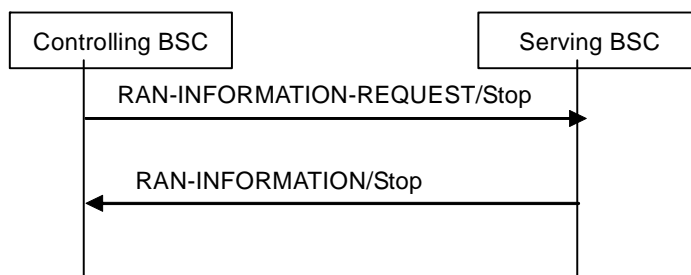

**Figure 8c.2.2.3: RAN Information Request/Stop Procedure**

#### 8c.2.2.3.1 Initiation by the controlling BSS

Upon initiation of the procedure, the controlling BSS shall:

- 1> set the content of the RAN-INFORMATION-REQUEST/Stop PDU as follows:
  - 2> set the *PDU type* IE, the *Destination Cell Identifier* IE and the *Source Cell Identifier* IE;
  - 2> set the content of the *RIM Container* IE as follows:
    - 3> set the *RIM Application Identity* IE and the *RIM Sequence Number* IE;
    - 3> set the *PDU Type Extension* field in the *RIM PDU Indications* IE to "RAN-INFORMATION-REQUEST/Stop";
    - 3> set the *RIM Protocol Version Number* IE if necessary (see sub-clause 8c.1.6);
    - 3> include the *Application Container* IE according to the requirements of the application;
- 1> send the RAN-INFORMATION-REQUEST/Stop PDU;
- 1> start T(RIR).

#### 8c.2.2.3.2 Reception of a valid RAN-INFORMATION-REQUEST/Stop PDU by the serving BSS

Upon reception of a valid RAN-INFORMATION-REQUEST/Stop PDU as defined in sub-clause 8c.3.2, the serving BSS shall:

- 1> if `MULTIPLE_REPORTING_ONGOING` is set to `TRUE` for this RIM association and if the received RAN-INFORMATION-REQUEST/Stop PDU is considered as having been sent earlier (see sub-clause 8c.1.5) than the PDU whose RSN is stored in `MULTIPLE_REPORT_SETTING_RSN`, then:
  - 2> discard the PDU without further actions and the procedure ends;
- 1> otherwise:
  - 2> set the `MULTIPLE_REPORTING_ONGOING` variable to `FALSE` for this RIM association;
  - 2> set the content of the RAN-INFORMATION/Stop as follows:
    - 3> set the *PDU type* IE; mirror the *Source Cell Identifier* IE value and the *Destination Cell Identifier* IE value of the RAN-INFORMATION-REQUEST/Stop PDU respectively into the *Destination Cell Identifier* IE and the *Source Cell Identifier* IE of the RAN-INFORMATION/Stop PDU;
    - 3> set the content of the *RIM Container* IE as follows:
      - 4> set the *RIM Application Identity* IE as required by the application;
      - 4> set the *RIM Sequence Number* IE and, if necessary, the *RIM Protocol Version Number* IE (see sub-clause 8c.1.6);
      - 4> set the *ACK* indicator in the *RIM PDU Indications* IE to "No ACK requested";
      - 4> set the *PDU Type Extension* field in the *RIM PDU Indications* IE to "RAN-INFORMATION/Stop";
      - 4> include either the *Application Container* IE or the *Application Error Container* IE according to the requirements of the application;
  - 2> send the RAN-INFORMATION/Stop PDU.

#### 8c.2.2.3.3 Reception of a valid RAN-INFORMATION/Stop PDU by the controlling BSS

Upon reception of a valid RAN-INFORMATION/Stop PDU as defined in sub-clause 8c.3.2 the controlling BSS shall:

- 1> stop T(RIR) for this RIM association;
- 1> deliver the relevant information to the application;

and the procedure ends.

#### 8c.2.2.3.4 Expiration of T(RIR) in the controlling BSS

If T(RIR) expires the controlling BSS shall as an implementation option either inform the application that the procedure has failed or restart the RAN Information Request/Stop procedure a finite number of times as described in sub-clause 8c.2.2.3.1.

### 8c.2.3 RAN Information Send procedure

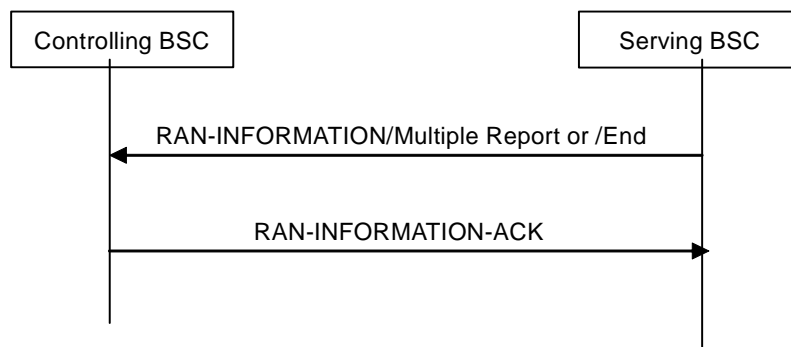

**Fig 8c.2.3: Acknowledged RAN Information Send procedure**

#### 8c.2.3.1 Initiation by the serving BSS

If multiple reporting has been requested for a given RIM association (i.e. the `MULTIPLE_REPORTING_ONGOING` variable is set to `TRUE`), the RAN Information Send procedure is initiated by the application in the serving BSS either to send updated information (using the RAN-INFORMATION/Multiple Report PDU) or to indicate that multiple reporting has been deactivated on the serving BSS side (using the RAN-INFORMATION/End PDU).

Upon initiation of the procedure, the serving BSS shall:

- 1> set the content of the RAN-INFORMATION PDU as follows:
  - 2> set the *PDU type* IE, mirror the *Source Cell Identifier* IE value and the *Destination Cell Identifier* IE value of the RAN-INFORMATION-REQUEST/Multiple Report PDU that is identified by the RSN stored in the `MULTIPLE_REPORT_SETTING_RSN` variable respectively into the *Destination Cell Identifier* IE and the *Source Cell Identifier* IE of the RAN-INFORMATION PDU;
  - 2> set the content of the *RIM Container* IE as follows:
    - 3> mirror the *RIM Application Identity* IE value of the RAN-INFORMATION-REQUEST/Multiple Report PDU that is identified by the RSN stored in the `MULTIPLE_REPORT_SETTING_RSN` variable into the *RIM Application Identity* IE of the RAN-INFORMATION PDU;
    - 3> set the *RIM Sequence Number* IE and, if necessary, the *RIM Protocol Version Number* IE (see sub-clause 8c.1.6);
    - 3> set the *PDU Type Extension* field in the *RIM PDU Indications* IE to "RAN-INFORMATION/Multiple Report" or "RAN-INFORMATION/End" as required by the application;
    - 3> for a RAN-INFORMATION/Multiple Report PDU, set the *ACK* indicator to the value required by the application; for a RAN-INFORMATION/End PDU, set the *ACK* indicator to "ACK requested";
    - 3> set the *Application Container* IE according to the requirements of the application;
- 1> if the RAN-INFORMATION PDU is a RAN-INFORMATION/End (multiple reporting deactivated), set the `MULTIPLE_REPORTING_ONGOING` variable to `FALSE`;
- 1> send the RAN-INFORMATION PDU;
- 1> if the *ACK* indicator has been set to "ACK requested", start a T(RI) instance for this RAN-INFORMATION PDU;
- 1> otherwise the procedure ends.



### 8c.2.3.2 Reception of a valid RAN-INFORMATION PDU by the controlling BSS

Upon reception of a valid RAN-INFORMATION/Multiple Report or RAN-INFORMATION/End PDU as defined in sub-clause 8c.3.2 the controlling BSS shall:

- 1> deliver the relevant information to the application;
- 1> if the *ACK* indicator in the *RIM PDU Indications* IE included in the RIM container of the RAN-INFORMATION PDU is set to "ACK requested", the controlling BSS shall:
  - 2> set the content of the RAN-INFORMATION-ACK PDU as follows:
    - 3> set the *PDU type* IE; mirror the *Source Cell Identifier* IE value and the *Destination Cell Identifier* IE value of the RAN-INFORMATION PDU respectively into the *Destination Cell Identifier* IE and the *Source Cell Identifier* IE of the RAN-INFORMATION-ACK PDU;
    - 3> set the content of the *RIM Container* IE as follows:
      - 4> mirror the *RIM Sequence Number* IE value and the *RIM Application Identity* IE value included in the RIM container of the RAN-INFORMATION PDU respectively into the *RIM Sequence Number* IE and the *RIM Application Identity* IE of the RAN-INFORMATION-ACK PDU;
      - 4> set, if necessary, the *RIM Protocol Version Number* IE (see sub-clause 8c.1.6);

NOTE: If the RAN-INFORMATION PDU is a RAN-INFORMATION/End, the controlling BSS shall consider that multiple reporting is deactivated for this RIM association in the serving BSS.

- 2> send the RAN-INFORMATION-ACK PDU.
- 1> otherwise, the procedure ends.

### 8c.2.3.3 Reception of a valid RAN-INFORMATION-ACK PDU in the serving BSS

Upon reception of a valid RAN-INFORMATION-ACK PDU as defined in sub-clause 8c.3.2 the serving BSS shall:

- 1> if the *RIM Sequence Number* IE value contained in the RAN-INFORMATION-ACK PDU matches the RSN of the RAN-INFORMATION PDU having initiated the procedure then:
  - 2> stop the T(RI) instance corresponding to the acknowledged PDU;

and the procedure ends.

### 8c.2.3.4 Expiration of T(RI) in the serving BSS

Upon expiration of the T(RI) instance the serving BSS shall, as an implementation option, either inform the application that the procedure has failed or restart the RAN Information Send procedure a finite number of times as described in sub-clause 8c.2.3.1.

## 8c.2.4 RAN Information Application Error procedure

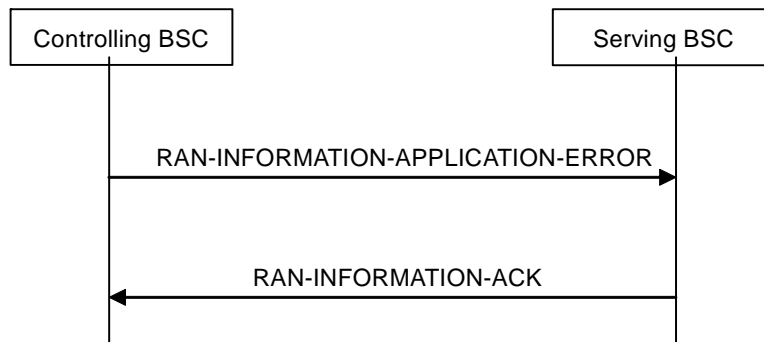

**Fig 8c.2.4: RAN Information Application Error procedure**

### 8c.2.4.1 Initiation by the controlling BSS

Upon initiation of the procedure, the controlling BSS shall:

- 1> set the content of the RAN-INFORMATION-APPLICATION-ERROR PDU as follows:
  - 2> set the *PDU type* IE, mirror the *Source Cell Identifier* IE value and the *Destination Cell Identifier* IE value of the RAN-INFORMATION PDU with the erroneous application container respectively into the *Destination Cell Identifier* IE and the *Source Cell Identifier* IE of the RAN-INFORMATION-APPLICATION-ERROR PDU;
  - 2> set the content of the *RIM Container* IE as follows:
    - 3> set the *RIM Application Identity* IE and the *RIM Sequence Number* IE;
    - 3> set the *RIM Protocol Version Number* IE if necessary (see sub-clause 8c.1.6);
    - 3> set the *ACK* indicator in the *RIM PDU Indications* IE according to the requirements of the application;
    - 3> include the *Application Error Container* IE according to the requirements of the application
- 1> send the RAN-INFORMATION-APPLICATION-ERROR PDU to the serving BSS;
- 1> if the *ACK* indicator has been set to "ACK requested", start a T(RIAE) instance for this RAN-INFORMATION-APPLICATION-ERROR PDU;
- 1> otherwise the procedure ends.

### 8c.2.4.2 Reception of a valid RAN-INFORMATION-APPLICATION-ERROR PDU by the serving BSS

Upon reception of a valid RAN-INFORMATION-APPLICATION-ERROR PDU as defined in sub-clause 8c.3.2 the serving BSS shall:

- 1> deliver the relevant information to the application;
- 1> if the *ACK* indicator in the *RIM PDU Indications* IE included in the RIM container of the RAN-INFORMATION-APPLICATION-ERROR PDU is set to "ACK requested", then the serving BSS shall:
  - 2> set the content of the RAN-INFORMATION-ACK PDU as follows:
    - 3> set the *PDU type* IE, mirror the *Source Cell Identifier* IE value and the *Destination Cell Identifier* IE value of the RAN-INFORMATION-APPLICATION-ERROR PDU respectively into the *Destination Cell Identifier* IE and the *Source Cell Identifier* IE of the RAN-INFORMATION-ACK PDU;
    - 3> set the content of the *RIM Container* IE as follows:

4> mirror the *RIM Sequence Number* IE value and the *RIM Application Identity* IE value included in the RIM container of the RAN-INFORMATION-APPLICATION-ERROR PDU respectively into the *RIM Sequence Number* IE and the *RIM Application Identity* IE of the RAN-INFORMATION-ACK PDU;

4> set the *RIM Protocol Version Number* IE if necessary (see sub-clause 8c.1.6);

2> send the RAN-INFORMATION-ACK PDU.

1> otherwise, the procedure ends.

### 8c.2.4.3 Reception of a valid RAN-INFORMATION-ACK PDU by the controlling BSS

Upon reception of a valid RAN-INFORMATION-ACK PDU as defined in sub-clause 8c.3.2, the controlling BSS shall:

1> if the *RIM Sequence Number* IE value contained in the RAN-INFORMATION-ACK PDU matches the RSN of the RAN-INFORMATION-APPLICATION-ERROR PDU having initiated the procedure

2> then stop the T(RIAE) instance corresponding to the acknowledged PDU;

1> else discard the PDU without further action;

and the procedure ends.

### 8c.2.4.4 Expiration of T(RIAE) in the controlling BSS

At the expiration of the T(RIAE) instance corresponding to the RAN-INFORMATION-APPLICATION-ERROR PDU sent previously by the controlling BSS, the controlling BSS shall, as an implementation option, either inform the application that the procedure has failed or restart the RAN Information Application Error procedure a finite number of times as described in sub-clause 8c.2.4.1.

## 8c.2.5 RAN Information Error procedure

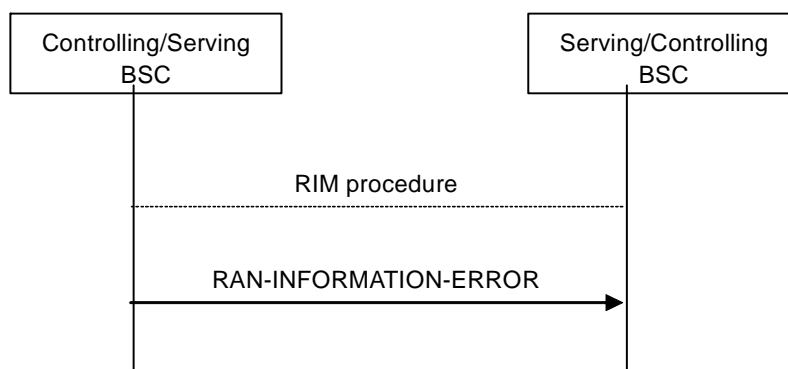

**Fig 8c.2.5: RAN Information Error procedure**

The RAN Information Error procedure is initiated by the RIM in the source BSS (controlling or serving) to transfer error information to the RIM entity in the associated BSS;

The procedure is described in sub-clause 8c.3.4.

## 8c.3 Abnormal conditions

### 8c.3.0 General

Two levels of abnormal conditions are defined for the RIM function:

- the abnormal conditions encountered at the BSSGP level as described in sub-clause 8c.3.1, affecting the routing mechanisms and the related IEs in the RIM PDUs;

- the abnormal conditions encountered in the RIM container as described in sub-clauses 8c.3.2 and 8c.3.3.

The errors encountered in the application container are handled by the application and are made known to the peer application entity by including the *Application Error container* IE.

## 8c.3.1 Abnormal conditions at the BSSGP level

### 8c.3.1.1 General

The general protocol error handling as defined in section 9 applies.

However, the RIM containers being defined as general containers for passing field elements transparently between BSSs via the core network are not subject to error handling at the BSSGP level but only at the RIM protocol level (see sub-clause 8c.3.2).

Additionally the abnormal conditions defined in the following sub-clauses apply.

### 8c.3.1.2 RIM addressing error in BSS

If a BSS receives from an SGSN a RIM PDU with a *Destination Cell Identifier* IE value which does not match the cell identifier of any of its parented cells, the PDU shall be discarded and a STATUS PDU with the cause value set to "Unknown Destination address" shall be sent back to the SGSN.

### 8c.3.1.3 RIM addressing error in the CN

If an SGSN receives from a BSS a RIM PDU with an invalid destination address, the PDU shall be discarded and a STATUS PDU with the cause value set to "Unknown Destination address" shall be sent back to the BSS.

### 8c.3.1.4 RIM PDU addressed to a BSS not supporting RIM

If an SGSN receives a RIM PDU addressed to a parented BSS that does not support the RIM procedures, the PDU shall be discarded without further action.

## 8c.3.2 Abnormal conditions encountered in the RIM container

### 8c.3.2.1 Unknown RIM Application Identity

If the RIM container included in a RAN-INFORMATION PDU, RAN-INFORMATION-REQUEST PDU, RAN-INFORMATION-ACK PDU or RAN-INFORMATION-APPLICATION-ERROR PDU contains an unknown value in the *RIM Application Identity* IE, or if the RIM container contains an unknown value in the *SON Transfer Application Identity* IE in case the *RIM Application Identity* IE is set to "SON Transfer", or if the RIM application is disabled when receiving a RAN-INFORMATION-REQUEST PDU, the BSS shall send a RAN-INFORMATION-ERROR PDU with the *RIM Cause* IE set to "Unknown RIM Application Identity or RIM application disabled" back to the originating BSS (see sub-clause 8c.3.4.2) and discard the received PDU.

If the RIM container included in a RAN-INFORMATION-ERROR PDU contains an unknown value in the *RIM Application Identity* IE, or if the RIM container contains an unknown value in the *SON Transfer Application Identity* IE in case the *RIM Application Identity* IE is set to "SON Transfer", the BSS shall discard the RIM PDU without further action.

### 8c.3.2.2 Erroneous PDU Type Extension field

If the *PDU Type Extension* field in the *RIM PDU Indications* IE included in the RIM container of a RAN-INFORMATION-REQUEST PDU does not indicate "RAN-INFORMATION-REQUEST/Multiple Report", "RAN-INFORMATION-REQUEST/Stop" or "RAN-INFORMATION-REQUEST/Single Report", the serving BSS shall send a RAN-INFORMATION-ERROR PDU containing the complete received PDU and with the *RIM Cause* IE set to "PDU not compatible with the feature set" back to the originating BSS (see sub-clause 8c.3.4.2) and shall discard the received PDU.

If the *PDU Type Extension* field in the *RIM PDU Indications* IE included in the RIM container of a RAN-INFORMATION PDU does not indicate "RAN-INFORMATION/Single Report", "RAN-INFORMATION/Multiple Report", "RAN-INFORMATION/Initial Multiple Report", "RAN-INFORMATION/Stop" or "RAN-INFORMATION/End", the serving BSS shall send a RAN-INFORMATION-ERROR PDU containing the complete received PDU and with the *RIM Cause* IE set to "PDU not compatible with the feature set" back to the originating BSS (see sub-clause 8c.3.4.2) and shall discard the received PDU.

### 8c.3.2.3 Missing conditional IE

If an expected conditional Information Element is not included in the RIM container of a RAN-INFORMATION PDU, RAN-INFORMATION-REQUEST PDU, RAN-INFORMATION-ACK PDU or RAN-INFORMATION-APPLICATION-ERROR PDU, the BSS shall send a RAN-INFORMATION-ERROR PDU containing the complete received PDU and with the *RIM Cause* IE set to "Missing Conditional IE" back to the originating BSS (see sub-clause 8c.3.4.2) and discard the received PDU.

If an expected conditional Information Element is not included in the RIM container of a RAN-INFORMATION-ERROR PDU, the BSS shall discard the received PDU without further action.

### 8c.3.2.4 Missing mandatory IE

If a mandatory Information Element is not included in the RIM container of a RAN-INFORMATION PDU, RAN-INFORMATION-REQUEST PDU, RAN-INFORMATION-ACK PDU or RAN-INFORMATION-APPLICATION-ERROR PDU, the BSS shall send a RAN-INFORMATION-ERROR PDU containing the complete received PDU and with the *RIM Cause* IE set to "Missing Mandatory IE" back to the originating BSS (see sub-clause 8c.3.4.2) and discard the received PDU.

If a mandatory Information Element is not included in the RIM container of a RAN-INFORMATION-ERROR PDU, the BSS shall discard the received PDU without further action.

### 8c.3.2.5 Syntactical error in an expected conditional IE

If a syntactical error is detected in an expected conditional Information Element included in the RIM container of a RAN-INFORMATION PDU, RAN-INFORMATION-REQUEST PDU, RAN-INFORMATION-ACK PDU or RAN-INFORMATION-APPLICATION-ERROR PDU, the BSS shall send a RAN-INFORMATION-ERROR PDU containing the complete received PDU and with the *RIM Cause* IE set to "Conditional IE error" back to the originating BSS (see sub-clause 8c.3.4.2) and discard the received PDU.

If a syntactical error is detected in an expected conditional Information Element included in the RIM container of a RAN-INFORMATION-ERROR PDU, the BSS shall discard the received PDU without further action.

### 8c.3.2.6 Syntactical error in a mandatory IE

If a syntactical error is detected in a mandatory IE included in the RIM container of a RAN-INFORMATION PDU, RAN-INFORMATION-REQUEST PDU, RAN-INFORMATION-ACK PDU or RAN-INFORMATION-APPLICATION-ERROR PDU, the BSS shall send a RAN-INFORMATION-ERROR PDU containing the complete received PDU and with the *RIM Cause* IE set to "Invalid mandatory information" back to the originating BSS (see sub-clause 8c.3.4.2) and discard the received PDU.

For this rule the following exceptions apply:

- unknown *RIM Application Identity* IE (see sub-clause 8c.3.2.1); or
- erroneous *PDU Type Extension* field (see sub-clause 8c.3.2.2)

If a syntactical error is detected in a mandatory IE included in the RIM container of a RAN-INFORMATION-ERROR PDU, the BSS shall discard the received PDU without further action.

### 8c.3.2.7 Unexpected conditional IE

If an unexpected conditional Information Element is received in the RIM container of a RAN-INFORMATION PDU, RAN-INFORMATION-REQUEST PDU, RAN-INFORMATION-ACK PDU or RAN-INFORMATION-APPLICATION-ERROR PDU, the BSS shall send a RAN-INFORMATION-ERROR PDU containing the complete

received PDU and with the *RIM Cause* IE set to "Unexpected Conditional IE" back to the originating BSS (see sub-clause 8c.3.4.2) and discard the received PDU.

If an unexpected conditional Information Element is received in the RIM container of a RAN-INFORMATION-ERROR PDU, the BSS shall discard the received PDU without further action.

### 8c.3.2.8 Containers with out-of-sequence information elements

The receiving BSS may accept RIM containers that include information elements that do not appear to be in the correct sequence. Elements that occur more than once in a RIM container shall be assumed to have been transmitted in the correct order. Recipients that do not accept out of sequence information elements shall regard the RIM container as containing unexpected and/or missing information elements and follow the procedures defined in the rest of this sub-clause 8c.3.2.

### 8c.3.2.9 Container with semantically incorrect content

When any IE with semantically incorrect contents is received within a RIM container, the receiving BSS shall react according to the relevant protocol specification. If however no such reactions are specified, the receiving BSS shall ignore that IE and treat the rest of the RIM container. If the rest of the RIM container can no longer be handled because this IE was ignored then the receiving BSS shall send a RAN-INFORMATION-ERROR PDU containing the complete received PDU and with the *RIM Cause* IE set to "Semantically incorrect PDU" back to the originating BSS (see sub-clause 8c.3.4.2) and discard the received PDU.

## 8c.3.3 Unexpected RIM PDU

If a BSS receives a RIM PDU in a case not covered by the RIM procedures specified in sub-clause 8c.2, it shall discard the RIM PDU without further action.

## 8c.3.4 RIM error reporting

### 8c.3.4.1 General

A BSS diagnosing any of the abnormal cases identified in sub-clause 8c.3.2 in a received RIM PDU shall inform the originating BSS by sending in return a RAN-INFORMATION-ERROR PDU as described in sub-clause 8c.3.4.2.

The tasks to be performed upon reception of the RAN-INFORMATION-ERROR PDU are described in sub-clause 8c.3.4.3.

### 8c.3.4.2 Sending of a RAN-INFORMATION-ERROR PDU

A BSS receiving an erroneous RIM PDU according to sub-clause 8c.3.2 shall:

- 1> set the *PDU type* IE, mirror the *Source Cell Identifier* IE value and the *Destination Cell Identifier* IE value of the erroneous RIM PDU respectively into the *Destination Cell Identifier* IE and the *Source Cell Identifier* IE of the RAN-INFORMATION-ERROR PDU
- 1> set the content of *RIM Container* IE as follows:
  - 2> mirror the *RIM Application Identity* IE value of the erroneous RIM PDU into the *RIM Application Identity* IE in the *RIM Container* IE of the RAN-INFORMATION-ERROR PDU;
  - 2> set the *RIM Cause* IE and, if necessary, the *RIM Protocol Version Number* IE (see sub-clause 8c.1.6);
  - 2> include the complete erroneous RIM PDU in to the *PDU in Error* IE;
- 1> send the RAN-INFORMATION-ERROR PDU.

### 8c.3.4.3 Reception of a RAN-INFORMATION-ERROR PDU in the BSS

Upon reception of an erroneous RAN-INFORMATION-ERROR PDU according to sub-clause 8c.3.2 the BSS shall discard the received PDU without further action.

The actions to be taken upon reception of a valid RAN-INFORMATION-ERROR PDU are an implementation-dependent option.

## 8c.4 RIM timers

The following RIM timers are defined:

- T(RIR) is used in the controlling BSS to control the reception of the response to a previously transmitted RAN-INFORMATION-REQUEST PDU.
- T(RI) is used in the serving BSS used to control the reception of the acknowledgement of a previously transmitted RAN-INFORMATION PDU.
- T(RIAE) is used in the controlling BSS used to control the reception of the acknowledgement of a previously transmitted RAN-INFORMATION-APPLICATION-ERROR PDU.

**Table 8c.4: RIM timers**

Timer	Start	Stop	Action at expiry
T(RIR)	Transmission of a RAN-INFORMATION-REQUEST/Multiple Report PDU	Reception of the answering RAN-INFORMATION/Initial Multiple Report	Either (implementation option) inform the application that the procedure has failed or restart the procedure a finite number of times
	Transmission of a RAN-INFORMATION-REQUEST/Single Report PDU	Reception of the answering RAN-INFORMATION/Single Report	Either (implementation option) inform the application that the procedure has failed or restart the procedure a finite number of times
	Transmission of a RAN-INFORMATION-REQUEST/Stop PDU	Reception of the answering RAN-INFORMATION/Stop	Either (implementation option) inform the application that the procedure has failed or restart the procedure a finite number of times
T(RI)	Transmission of a RAN-INFORMATION/Multiple Report or RAN-INFORMATION/End PDU	Reception of the answering RAN-INFORMATION-ACK	Either (implementation option) inform the application that the procedure has failed or restart the procedure a finite number of times
T(RIAE)	Transmission of a RAN-INFORMATION-APPLICATION-ERROR PDU	Reception of the answering RAN-INFORMATION-ACK	Either (implementation option) inform the application that the procedure has failed or restart the procedure a finite number of times

## 8c.5 Action upon deletion of a cell in a BSS

### 8c.5.0 General

The deletion of a cell in a BSS should trigger the actions described in this sub-clause to ensure the proper operation of the RIM procedures for RIM associations related to this cell.

#### 8c.5.1 Actions due to the deletion of the cell

If the deleted cell has to report to one or more controlling BSS(s), the serving BSS parenting the deleted cell shall trigger a RAN Information Send procedure to inform each of the corresponding controlling BSS(s) that multiple reporting has been deactivated by the sending of a RAN-INFORMATION/End PDU.

The controlling BSS parenting the deleted cell may also decide that, as a consequence of the deletion of this cell, some multiple reports previously requested from some cells parented by other BSS(s) are no longer needed and shall trigger the relevant RAN Information Request/Stop procedure.

## 8c.5.2 Additional actions in the case the deleted cell is used as a source cell by RIM

If the cell identifier of the cell being deleted has been used as the *Source Cell Identifier* IE value in a previous RAN-INFORMATION-REQUEST/Multiple report PDU, the deletion of this cell shall trigger the following additional actions to update this information in the serving BSS, as the *Source Cell Identifier* IE is used by the serving BSS to address the controlling BSS (address mirroring - see sub-clause 8c.1.4.3):

- The controlling BSS parenting this cell shall trigger a RAN Information Request/Stop procedure for each of the involved cells in the serving BSS;
- After the completion of this procedure the parenting BSS shall, if event-based multiple reporting is still needed from the involved cells, trigger further RAN Information Request/Multiple Report procedure(s) with a different cell identifier as *Source Cell Identifier* IE value.

## 8c.6 Specific requirements related to RIM applications

### 8c.6.0 General requirements

Any error condition detected in the *Application Error Container* IE included in the *RIM Container* IE of a valid RIM PDU shall not be reported to the peer application entity.

Any error condition detected in the *Application Container* IE included in the *RIM Container* IE of an erroneous RIM PDU shall not trigger a RAN Information Application Error procedure.

A controlling BSS shall not send another RAN-INFORMATION-REQUEST PDU for the same association before the first RAN-INFORMATION-REQUEST PDU has been acknowledged or before T(RIR) associated to this request has expired.

### 8c.6.1 Requirements related to the NACC RIM application

The rules specified in this sub-clause apply when the *RIM Application Identity* IE is set to "Network Assisted Cell Change (NACC)":

- The RAN-INFORMATION-REQUEST PDU is used by a controlling BSS to request the system information required for NACC operation in the controlling BSS and related to a single cell parented by a serving BSS. The *Destination Cell Identifier* IE of the RAN-INFORMATION-REQUEST PDU shall be set to the value of the *Reporting Cell Identifier* field contained in the application container of the PDU.
- The presence of the *Application Container* IE is mandatory in the *RIM Container* IE of the RAN-INFORMATION-REQUEST PDU.
- The RAN-INFORMATION PDU is used by a serving BSS to send the system information required for NACC operation (i.e. if a PBCCH is allocated in the cell, PSI1, a consistent set of PSI2 and PSI14 messages; if no PBCCH is allocated in the cell, SI3, SI13 and, if available, SI1 messages - see 3GPP TS 4.060) related to a single reporting cell, to a controlling BSS.
- In the present specification, NACC between UTRAN and GERAN is restricted to the case of a controlling RNS and a serving BSS (i.e. assistance is provided for MSs moving from UTRAN to GERAN) and NACC between E-UTRAN and GERAN is restricted to the case of a controlling eNodeB and a serving BSS (i.e. assistance is provided for MSs moving from E-UTRAN to GERAN). The reporting cell located in the serving BSS is therefore always a GERAN cell and shall be addressed as such (RAI + CI) in the NACC application containers.
- The presence of the *Application Container* IE is mandatory in the *RIM Container* IE of the RAN-INFORMATION PDU, except in the case of a RAN-INFORMATION/Initial Multiple Report PDU and of a RAN-INFORMATION/Single Report PDU, where the *Application Error Container* IE may be included instead.
- When multiple reports from a certain cell have been requested, the RAN-Information Send procedure shall be triggered every time the set of NACC related (packet) system information for this cell is changed; the NACC application shall request acknowledgements.



- The *Application Container* IE included in the *RIM container* IE of a RAN-INFORMATION/End PDU or of a RAN-INFORMATION/Stop PDU shall contain only the identity of the reporting cell.

## 8c.6.2 SI3 application

The rules specified in this sub-clause apply when the *RIM Application Identity* IE is set to "SI3":

- the RAN-INFORMATION-REQUEST PDU is used by a controlling BSS to request system information type 3 related to a single cell parented by a serving BSS. The *Destination Cell Identifier* IE of the RAN-INFORMATION-REQUEST PDU shall be set to the value of the *Reporting Cell Identifier* field contained in the application container of the PDU.
- The presence of the *Application Container* IE is mandatory in the *RIM Container* IE of the RAN-INFORMATION-REQUEST PDU.
- The RAN-INFORMATION PDU is used by a serving BSS to send system information type 3 related to a single reporting cell, to a controlling BSS.
- The presence of the *Application Container* IE is mandatory in the *RIM Container* IE of the RAN-INFORMATION PDU, except in the case of a RAN-INFORMATION/Initial Multiple Report PDU and of a RAN-INFORMATION/Single Report PDU, where the *Application Error Container* IE may be included instead.
- When multiple reports from a certain cell have been requested, the RAN-Information Send procedure shall be triggered every time the system information type 3 for this cell is changed; the SI3 application shall request acknowledgements.
- The *Application Container* IE included in the *RIM container* IE of a RAN-INFORMATION/End PDU or of a RAN-INFORMATION/Stop PDU shall contain only the identity of the reporting cell.

## 8c.6.3 MBMS data channel application

The rules specified in this sub-clause apply when the *RIM Application Identity* IE is set to "MBMS data channel":

- The RAN-INFORMATION-REQUEST PDU is used by a controlling BSS to request the information about the MBMS data channels established in a single cell controlled by a serving BSS. The *Destination Cell Identifier* IE of the RAN-INFORMATION-REQUEST PDU shall be set to the value of the *Reporting Cell Identifier* field contained in the application container of the PDU.
- The presence of the *Application Container* IE is mandatory in the *RIM Container* IE of the RAN-INFORMATION-REQUEST PDU.
- The RAN-INFORMATION PDU is used by a serving BSS to send the information about the MBMS data channels established in a single reporting cell, to a controlling BSS.
- The presence of the *Application Container* IE is mandatory in the *RIM Container* IE of the RAN-INFORMATION PDU, except in the case of a RAN-INFORMATION/Initial Multiple Report PDU and of a RAN-INFORMATION/Single Report PDU, where the *Application Error Container* IE may be included instead.
- When multiple reports from a certain cell have been requested, the RAN-Information Send procedure shall be triggered every time the allocation of the MBMS data channel is changed (i.e. established, reconfigured, abnormally released) for any MBMS session ongoing in the reporting cell. The MBMS data channel application shall request acknowledgements. However the normal release (i.e. resulting from a MBMS-SESSION-STOP-REQUEST PDU received from the SGSN) of the MBMS data channel at the end of a session shall not trigger the RAN-Information Send procedure, but assumed implicitly as done at the end of the session by the the controlling BSS.
- The *Application Container* IE included in the *RIM container* IE of a RAN-INFORMATION/End PDU or of a RAN-INFORMATION/Stop PDU shall contain only the identity of the reporting cell.

## 8c.6.4 Requirements related to the SON Transfer RIM application

The introduction of generic SON Transfer containers in TS 36.413 [36] means that the RIM procedure itself has to be understood in a more generic way for the SON Transfer RIM application: the RIM procedure triggered by the Controlling BSS is used to exchange between BSSs SON Transfer Request container (controlling ---> serving) and SON Transfer Response container (serving ---> controlling), the precise content of these containers (possibly NULL) being linked with the SON Transfer Application in use. The Reporting Cell Identifier may either identify a cell in the serving BSS or in the controlling BSS, depending on the value of the SON Transfer Application Identity as specified in TS 36.413 [36].

The rules specified in this sub-clause apply when the *RIM Application Identity* IE is set to "SON Transfer":

- The RAN-INFORMATION-REQUEST PDU is used by a controlling BSS to send the SON Transfer Request container to the serving BSS as specified in TS 36.413 [36].
- The procedure shall be triggered using single report or multiple reports.
- The RAN-INFORMATION PDU is used by a serving BSS to send the SON Transfer Response Container to a controlling BSS as specified in TS 36.413 [36].
- The presence of the *Application Container* IE is mandatory in the *RIM Container* IE of the RAN-INFORMATION PDU, except in the case of a RAN-INFORMATION/Initial Multiple Report PDU and of a RAN-INFORMATION/Single Report PDU, where the *Application Error Container* IE may be included instead.
- When multiple reports have been requested, the RAN-Information Send procedure shall be triggered every time a SON Transfer Response Container must be sent. The RAN-Information Send procedure shall be used with lower priority with respect to the MS/UE dedicated signalling.

## 8c.6.5 Requirements related to the UTRA SI RIM application

The rules specified in this sub-clause apply when the *RIM Application Identity* IE is set to "UTRA System Information (UTRA SI)":

- The RAN-INFORMATION-REQUEST PDU is used by a controlling BSS to request the UTRA system information in the controlling BSS and related to a cell parented by a serving BSS.
- The presence of the *Application Container* IE is mandatory in the *RIM Container* IE of the RAN-INFORMATION-REQUEST PDU.
- The RAN-INFORMATION PDU is used by a serving BSS to send the UTRA system information related to a cell, to a controlling BSS.
- In the present specification, UTRA SI is transferred only to E-UTRAN. The reporting cell located in the serving BSS is always a cell and shall be addressed by the UTRAN Source Cell ID in the UTRA SI application containers.
- The presence of the *Application Container* IE is mandatory in the *RIM Container* IE of the RAN-INFORMATION PDU, except in the case of a RAN-INFORMATION/Initial Multiple Report PDU and of a RAN-INFORMATION/Single Report PDU, where the *Application Error Container* IE may be included instead.
- When multiple reports from a certain cell have been requested, the RAN-Information Send procedure shall be triggered every time the set of UTRA system information managed by the UTRA SI RIM application for this cell is changed; the UTRA SI application shall request acknowledgements.
- The *Application Container* IE included in the *RIM container* IE of a RAN-INFORMATION/End PDU or of a RAN-INFORMATION/Stop PDU shall contain only the identity of the reporting cell.

## 8d Signalling procedures between MBMS SAPs

### 8d.1 General

Upon receiving an MBMS-SESSION-START-REQUEST PDU from the SGSN, if the BSS controls cells in any of the MBMS Service Areas in the MBMS service area list the BSS creates an MBMS Service Context, and acknowledges the SGSN using an MBMS-SESSION-START-RESPONSE PDU. More than one MBMS-SESSION-START-RESPONSE PDU can be sent from one BSS to the SGSN for the same MBMS-SESSION-START-REQUEST PDU.

Upon receiving an MBMS-SESSION-UPDATE-REQUEST PDU from the SGSN, the BSS updates the MBMS service area list for the ongoing MBMS broadcast service session and acknowledges the SGSN using an MBMS-SESSION-UPDATE-RESPONSE PDU. More than one MBMS-SESSION-UPDATE-RESPONSE PDU can be sent from one BSS to the SGSN for the same MBMS-SESSION-UPDATE-REQUEST PDU.

At the end of the MBMS Session the BSS receives an MBMS-SESSION-STOP-REQUEST PDU from the SGSN indicating that the MBMS Session can be released. The BSS acknowledges the request to end the MBMS Session by sending the MBMS-SESSION-STOP-RESPONSE PDU to the SGSN. See 3GPP TS 43.246 ([29]).

### 8d.2 MBMS Session Start

The BSS creates an MBMS Service Context if the BSS controls cells in the MBMS service area list upon reception of an MBMS-SESSION-START-REQUEST PDU from the SGSN.

If the data is received by the BSS and no MBMS bearer is established on the radio interface for that MBMS Session the BSS may buffer the data.

At reception of an MBMS-SESSION-START-REQUEST PDU that leads to an MBMS Service Context creation in the BSS, the BSS shall respond to the SGSN with an MBMS-SESSION-START-RESPONSE PDU with a Cause Value indicating that data transfer shall be initiated on the Point-to-Multipoint BVC from that SGSN.

The SGSN may include the *Allocation/Retention Priority* information element in the MBMS-SESSION-START-REQUEST PDU. If this information element is received and the BSS supports ARP handling, the BSS shall establish or modify the resources according to the values of the *Allocation/Retention Priority* IE (priority level, pre-emption indicators) and the resource situation as follows:

- The BSS shall consider the priority level of the requested MBMS bearer, when deciding on the resource allocation.
- The priority levels and the pre-emption indicators may (singularly or in combination) be used to determine whether the MBMS bearer establishment has to be performed unconditionally and immediately. If the requested MBMS bearer is marked as "may trigger pre-emption" and the resource situation requires so, the BSS may trigger the pre-emption procedure which may then cause the forced release of a lower priority bearer which is marked as "pre-emptable". Whilst the process and the extent of the pre-emption procedure is operator-dependent, the pre-emption indicators, if given in the MBMS-SESSION-START-REQUEST PDU, shall be treated as follows:
  1. If the *Pre-emption Capability* IE is set to "may trigger pre-emption", then this allocation request may trigger the pre-emption procedure. The BSS shall only pre-empt bearers (other MBMS bearers or MS specific bearers) with lower priority, in ascending order of priority.
  2. If the *Pre-emption Capability* IE is set to "shall not trigger pre-emption", then this allocation request shall not trigger the pre-emption procedure.
  3. If the *Pre-emption Vulnerability* IE is set to "pre-emptable", then this connection shall be included in the pre-emption process.
  4. If the *Pre-emption Vulnerability* IE is set to "not pre-emptable", then this connection shall not be included in the pre-emption process.

5. If the *Priority Level* IE is set to "no priority" the given values for the *Pre-emption Capability* IE and *Pre-emption Vulnerability* IE shall not be considered. Instead the values "shall not trigger pre-emption" and "not pre-emptable" shall prevail.
- If the *Allocation/Retention Priority* IE is not given in the MBMS-SESSION-START-REQUEST PDU, the allocation request shall not trigger the pre-emption process and the connection may be pre-empted and considered to have the value "lowest" as priority level.
  - The SGSN shall not include, and the BSS shall ignore, any queuing allowed indication in the *Allocation/Retention Priority* IE of the MBMS-SESSION-START-REQUEST PDU.

The *MBMS Session Repetition Number* IE shall be included in the MBMS-SESSION-START-REQUEST PDU in case the *MBMS Session Identity* IE is included in the same PDU (and vice versa). The *MBMS Session Repetition Number* IE allows the BSS to recognize retransmissions of a specific session of an MBMS bearer service. The value part of this IE may be used for e.g. deciding whether or not to initiate the counting procedure on a per cell basis (see 3GPP TS 44.018, 3GPP TS 44.060) or, in conjunction with the values of *Allocation/Retention Priority* IE, whether or not to establish an MBMS radio bearer for the session on a per cell basis.

At reception of an MBMS-SESSION-START-REQUEST PDU with the same TMGI IE and MBMS Session Identity IE as an ongoing MBMS Service Context, the BSS shall respond to the SGSN with an MBMS-SESSION-START-RESPONSE PDU with a Cause Value indicating that data transfer has already been initiated on the Point-to-Multipoint BVC from another SGSN.

At reception of an MBMS-SESSION-START-RESPONSE PDU, the SGSN shall either start data transfer or not depending on the received Cause Value.

After transmission of the MBMS-SESSION-START-RESPONSE PDU, the BSS shall wait at least the time specified in the value part of the *Time to MBMS Data Transfer* IE included in the MBMS-SESSION-START-REQUEST PDU and at most a time exceeding by 5 seconds the value part of the *Time to MBMS Data Transfer* IE for the first reception of the associated data before the BSS validates whether or not there is another SGSN that previously has sent an MBMS-SESSION-START-REQUEST PDU.

If after the start of the data flow associated to an MBMS Service Context, the BSS does not receive data for at least 30 seconds and the BSS has not received the MBMS-SESSION-STOP-REQUEST PDU, the BSS validates whether or not there is another SGSN that previously has sent an MBMS-SESSION-START-REQUEST PDU.

If, in any of the two cases mentioned above, another SGSN has sent an MBMS-SESSION-START-REQUEST PDU, the BSS shall send an MBMS-SESSION-START-RESPONSE PDU to such an SGSN with a Cause Value indicating that data transfer shall be initiated on the Point-to-Multipoint BVC from that SGSN. Otherwise, the BSS shall end the MBMS Service Context.

In any case, the BSS will send an MBMS-SESSION-START-RESPONSE PDU with a Cause Value indicating that the MBMS Service Context has been released due to interrupted data flow to the SGSN that previously has been ordered to perform data transfer.

If the BSS does not support any MBMS Service Area in the MBMS Service Area Identity List the BSS will send an MBMS-SESSION-START-RESPONSE PDU to the SGSN with Cause Value indicating that none of the listed MBMS Service Areas are supported by the BSS.

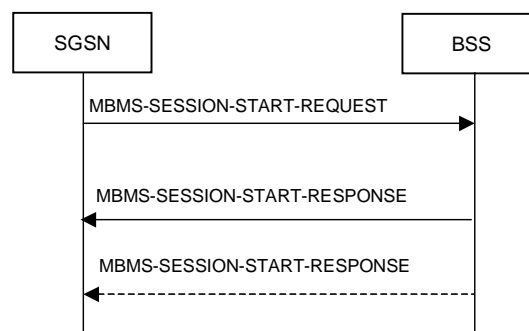

Figure 8d.2: MBMS Session Start procedure

## 8d.2.1 Abnormal Conditions

In any failure case in BSS the BSS may send an MBMS-SESSION-START-RESPONSE PDU including a Cause Value indicating the reason for the failure.

If an MBMS-SESSION-START-RESPONSE PDU is not received in response to an MBMS-SESSION-START-REQUEST PDU within T11 seconds, then the MBMS-SESSION-START-REQUEST PDU shall be repeated a maximum of MBMS-SESSION-START-REQUEST-RETRIES attempts. After MBMS-SESSION-START-REQUEST-RETRIES + 1 attempts the procedure is stopped and the O&M is informed.

## 8d.3 MBMS Session Stop

The SGSN may terminate an MBMS Session in the BSS by sending the MBMS-SESSION-STOP-REQUEST PDU to the BSS. The SGSN shall include the *MBMS Stop Cause* IE in the MBMS-SESSION-STOP-REQUEST PDU to indicate to the BSS if the MBMS Session termination has been ordered by an upstream node or if the SGSN itself has decided to terminate the MBMS Session (due to e.g. that the last MS that has an active MBMS UE Context for the MBMS Session within the SGSN has left the routing area(s) handled by the BSS).

The BSS ends an MBMS Service Context upon reception of an MBMS-SESSION-STOP-REQUEST PDU, including the *MBMS Stop Cause* IE indicating that an upstream node is terminating the MBMS Session, from the SGSN and acknowledges with an MBMS-SESSION-STOP-RESPONSE PDU.

At reception of an MBMS-SESSION-STOP-REQUEST PDU including the *MBMS Stop Cause* IE indicating that the SGSN is terminating the MBMS Session, the BSS shall validate whether or not there is another SGSN that previously has sent an MBMS-SESSION-START-REQUEST PDU or, in case of an MBMS broadcast service session, an MBMS-SESSION-UPDATE-REQUEST PDU.

If another SGSN has sent an MBMS-SESSION-START-REQUEST PDU or an MBMS-SESSION-UPDATE-REQUEST PDU, the BSS shall send an MBMS-SESSION-START-RESPONSE PDU or an MBMS-SESSION-UPDATE-RESPONSE PDU, respectively, to such an SGSN with a Cause Value indicating that data transfer shall be initiated on the Point-to-Multipoint BVC from that SGSN. Otherwise, the BSS shall end the MBMS Service Context. The BSS shall then acknowledge the MBMS-SESSION-STOP-REQUEST PDU by sending an MBMS-SESSION-STOP-RESPONSE PDU to the SGSN.

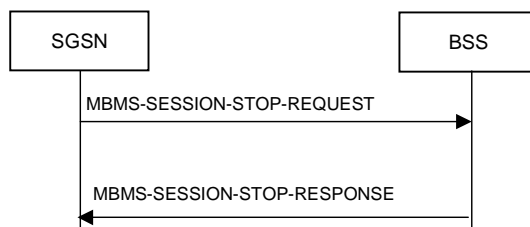

Figure 8d.3: MBMS Session Stop procedure

### 8d.3.1 Abnormal Conditions

If an MBMS-SESSION-STOP-RESPONSE PDU is not received in response to an MBMS-SESSION-STOP-REQUEST PDU within T11 seconds, then the MBMS-SESSION-STOP-REQUEST PDU shall be repeated a maximum of MBMS-SESSION-STOP-REQUEST-RETRIES attempts. After MBMS-SESSION-STOP-REQUEST-RETRIES + 1 attempts the procedure is stopped and the O&M is informed.

## 8d.4 MBMS Session Update

Upon reception of an MBMS-SESSION-UPDATE-REQUEST PDU from the SGSN for an ongoing MBMS broadcast service session, the BSS creates an MBMS Service Context if the BSS controls cells in the MBMS service area list and there is no ongoing MBMS Service Context identified with the same *TMGI* IE and, if available, *MBMS Session Identity* IE in the BSS.

Upon reception of an MBMS-SESSION-UPDATE-REQUEST PDU with the same *TMGI* IE and, if available, *MBMS Session Identity* IE as an ongoing MBMS Service Context but with (a) new MBMS Service Area(s) added to the *MBMS Service Area Identity List* IE, the BSS may send assignments for the ongoing MBMS broadcast service session to the mobile stations in the new MBMS Service Area(s) and repeat notifications to the mobile stations in the old MBMS Service Area(s).

Upon reception of an MBMS-SESSION-UPDATE-REQUEST PDU with the same *TMGI* IE and, if available, *MBMS Session Identity* IE as an ongoing MBMS Service Context but without (an) old MBMS Service Area(s) included any longer in the *MBMS Service Area Identity List* IE, the BSS shall release MBMS radio bearers relevant to the ongoing MBMS broadcast service session in the old MBMS Service Area(s).

The *MBMS Session Information* IE shall denote a Broadcast MBMS Session.

The *Allocation/Retention Priority* IE, if available, and the *MBMS Session Repetition Number* IE, if available, shall be handled by the BSS as described in the MBMS Session Start procedure (see sub-clause 8d.2).

If the *Allocation/Retention Priority* IE is not present in the MBMS-SESSION-UPDATE-REQUEST PDU, the allocation request shall not trigger the pre-emption process and the connection may be pre-empted and considered to have the value "lowest" as priority level.

If the data is received by the BSS and no MBMS bearer is established on the radio interface for that MBMS Session, the BSS may buffer the data.

At reception of an MBMS-SESSION-UPDATE-REQUEST PDU that leads to an MBMS Service Context creation in the BSS, the BSS shall respond to the SGSN with an MBMS-SESSION-UPDATE-RESPONSE PDU with a Cause Value indicating that data transfer shall be initiated on the Point-to-Multipoint BVC from that SGSN.

At reception of an MBMS-SESSION-UPDATE-REQUEST PDU with the same *TMGI* IE and, if available, *MBMS Session Identity* IE as an ongoing MBMS Service Context and including new and/or removing old MBMS Service Area(s), the BSS shall respond to the SGSN with an MBMS-SESSION-UPDATE-RESPONSE PDU with a Cause Value indicating either that data transfer shall continue on the Point-to-Multipoint BVC from that SGSN (see note) or that data transfer has already been initiated on the Point-to-Multipoint BVC from another SGSN.

NOTE: The Cause Value indicating that data transfer shall continue on the Point-to-Multipoint BVC from that SGSN is set to the same one denoting that data transfer shall be initiated on the Point-to-Multipoint BVC from that SGSN, i.e. "0001" (see sub-clause 11.3.74).

If the BSS does not support any MBMS Service Area in the *MBMS Service Area Identity List* IE, the BSS shall send an MBMS-SESSION-UPDATE-RESPONSE PDU to the SGSN with a Cause Value indicating that none of the listed MBMS Service Areas are supported by the BSS.

At reception of an MBMS-SESSION-UPDATE-RESPONSE PDU, the SGSN shall either start/continue data transfer or not depending on the received Cause Value.

After transmission of the MBMS-SESSION-UPDATE-RESPONSE PDU, the BSS shall wait at least the time specified in the value part of the *Time to MBMS Data Transfer* IE included in the MBMS-SESSION-UPDATE-REQUEST PDU and at most a time exceeding by 5 seconds the value part of the *Time to MBMS Data Transfer* IE for the first reception of the associated data before the BSS validates whether or not there is another SGSN that previously has sent an MBMS-SESSION-UPDATE-REQUEST PDU or an MBMS-SESSION-START-REQUEST PDU with the same content of the received MBMS-SESSION-UPDATE-REQUEST PDU.

If after the start of the data flow associated to an MBMS Service Context, the BSS does not receive data for at least 30 seconds and the BSS has not received the MBMS-SESSION-STOP-REQUEST PDU, the BSS validates whether or not there is another SGSN that previously has sent an MBMS-SESSION-UPDATE-REQUEST PDU or an MBMS-SESSION-START-REQUEST PDU with the same content of the received MBMS-SESSION-UPDATE-REQUEST PDU.

If, in any of the two cases mentioned above, another SGSN has sent an MBMS-SESSION-UPDATE-REQUEST PDU or an MBMS-SESSION-START-REQUEST PDU, the BSS shall send an MBMS-SESSION-UPDATE-RESPONSE PDU or an MBMS-SESSION-START-RESPONSE PDU, respectively, to such an SGSN with a Cause Value indicating that data transfer shall be initiated on the Point-to-Multipoint BVC from that SGSN. Otherwise, the BSS shall end the MBMS Service Context.

In any case, the BSS shall send an MBMS-SESSION-UPDATE-RESPONSE PDU with a Cause Value indicating that the MBMS Service Context has been released due to interrupted data flow to the SGSN that previously has been ordered to perform data transfer.

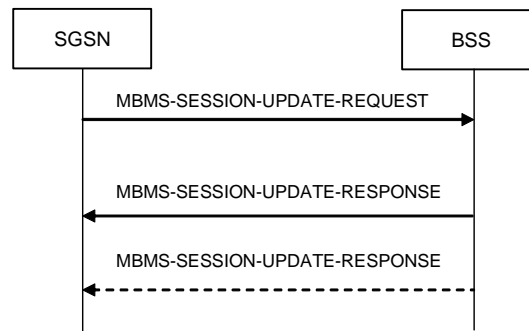

**Figure 8d.4: MBMS Session Update procedure**

### 8d.4.1 Abnormal Conditions

In any failure case in BSS the BSS may send an MBMS-SESSION-UPDATE-RESPONSE PDU including a Cause Value indicating the reason for the failure.

If an MBMS-SESSION-UPDATE-RESPONSE PDU is not received in response to an MBMS-SESSION-UPDATE-REQUEST PDU within T11 seconds, then the MBMS-SESSION-UPDATE-REQUEST PDU shall be repeated a maximum of MBMS-SESSION-UPDATE-REQUEST-RETRIES attempts. After MBMS-SESSION-UPDATE-REQUEST-RETRIES + 1 attempts the procedure is stopped and the O&M is informed.

---

## 9 General Protocol Error Handling

Refer to General Protocol Error Handling/3GPP TS 48.016. In addition:

- any type of BSSGP PDU received without an expected conditional IE is discarded and a STATUS PDU (cause "Missing conditional IE") is sent;
- any type of BSSGP PDU received without a mandatory IE is discarded and a STATUS PDU (cause "Missing mandatory IE") is sent;
- any type of BSSGP PDU received with a syntactical error in an expected conditional IE is discarded and a STATUS PDU (cause "Conditional IE error") is sent;
- any type of BSSGP PDU received with a syntactical error in a mandatory IE is discarded and a STATUS PDU (cause "Invalid mandatory information") is sent;
- any type of BSSGP PDU received for a feature that is not negotiated is discarded and a STATUS PDU (cause "PDU not compatible with the feature set") is sent.

Some BSSGP PDU shall contain one and only one conditional IE amongst a defined list of possible conditional IE (e.g. PAGING-PS PDU). If such a BSSGP PDU is received with more than one conditional IE amongst the defined list of possible conditional IE, as defined in sub-clause 10, the PDU is discarded and a STATUS PDU (cause "Unexpected conditional IE") is sent.

---

## 10 PDU functional definitions and contents

### 10.1 General Structure Of A PDU

Refer to General Structure Of A PDU/3GPP TS 48.016 [16].

## 10.2 PDU functional definitions and contents at RL and BSSGP SAPs

### 10.2.1 DL-UNITDATA

This PDU is sent to the BSS to transfer an LLC-PDU across the radio interface to an MS.

PDU type: DL-UNITDATA

Direction: SGSN to BSS

**Table 10.2.1: DL-UNITDATA PDU contents**

Information element	Type / Reference	Presence	Format	Length
---------------------	------------------	----------	--------	--------



Information element	Type / Reference	Presence	Format	Length
PDU type	PDU type/11.3.26	M	V	1
TLLI (current)	TLLI/11.3.35	M	V	4
QoS Profile (note 1)	QoS Profile/11.3.28	M	V	3
PDU Lifetime	PDU Lifetime/11.3.25	M	TLV	4
MS Radio Access Capability (note 2)	MS Radio Access Capability/11.3.22	O	TLV	7-?
Priority (note 3)	Priority/11.3.27	O	TLV	3
DRX Parameters (note 11)	DRX Parameters/11.3.11	O	TLV	4
IMSI	IMSI/11.3.14	O	TLV	5-10
TLLI (old)	TLLI/11.3.35	O	TLV	6
PFI	PFI/11.3.42	O	TLV	3
LSA Information	LSA Information/11.3.19	O	TLV	7-?
Service UTRAN CCO	Service UTRAN CCO/11.3.47	O	TLV	3
Subscriber Profile ID for RAT/Frequency priority (note 5)	Subscriber Profile ID for RAT/Frequency priority/11.3.105	O	TLV	3
Redirection Indication (note 6)	Redirection Indication/11.3.112	O	TLV	3
Redirection Completed (note 7)	Redirection Completed/11.3.113	O	TLV	3
Unconfirmed send state variable (note 9)	Unconfirmed send state variable/11.3.114	C	TLV	4
SCI (note 10)	SCI/ 11.3.116	O	TLV	3
GGSN/P-GW location (note 10)	GGSN/P-GW location/11.3.117	O	TLV	3
eDRX Parameters (note 11)	eDRX Parameters/11.3.122	O	TLV	3
Coverage Class	Coverage Class/11.3.124	O	TLV	3
Old Routing Area Identification (note 12)	Old Routing Area Identification/11.3.127	O	TLV	8
Attach Indicator (note 13)	Attach Indicator/11.3.128	O	TLV	3
Alignment octets	Alignment octets/11.3.1	O	TLV	2-5
LLC-PDU (note 4)	LLC-PDU/11.3.15	M	TLV	2-?
Initial LLC-PDU (note 8)	LLC-PDU/11.3.15	O	TLV	2-?
<p>NOTE 1: Some attributes of the QoS Profile shall be discarded if the PFI field is present and corresponds to a known PFC in the BSS.</p> <p>NOTE 2: The field shall be present if there is valid MS Radio Access Capability information known by the SGSN; the field shall not be present otherwise.</p> <p>NOTE 3: The priority field shall be discarded if the PFI field is present and corresponds to a known PFC in the BSS for which the ARP field was received.</p> <p>NOTE 4: The LLC-PDU Length Indicator may be zero.</p> <p>NOTE 5: This IE may be included if available in the SGSN. If the Service UTRAN CCO IE is present with the value of "shall not" the Service UTRAN CCO IE takes precedence over this IE.</p> <p>NOTE 6: This IE shall be included if Redirect Attempt flag was present in UL-UNITDATA and the CN requests rerouting by the BSC to another CN operator.</p> <p>NOTE 7: This IE shall be included if Redirect Attempt flag was present in UL-UNITDATA and the redirection is completed.</p> <p>NOTE 8: The initial Layer 3 Information received from MS. Only present when Redirection Indication is present.</p> <p>NOTE 9: Contains the value of the V(U) as defined in 3GPP TS 44.064 [12] if Redirection Indication IE is present.</p> <p>NOTE 10: These IEs are included when the SGSN supports the SIRUG feature and the received GTP-U packet contained the SCI IE.</p> <p>NOTE 11: If the SGSN has valid eDRX Parameters for a TLLI it shall include the eDRX Parameters IE (see sub-clause 6.1) in which case the DRX Parameters IE shall not be included.</p> <p>NOTE 12: This IE is only included when Redirection Indication is present and the SGSN supports CS/PS coordination enhancements.</p> <p>NOTE 13: This IE indicates a GPRS attach request from the MS. It may only be included if Redirection Indication is present and the SGSN supports CS/PS coordination enhancements.</p>				

## 10.2.2 UL-UNITDATA

This PDU transfers an MS's LLC-PDU and its associated radio interface information across the Gb-interface.

PDU type: UL-UNITDATA

Direction: BSS to SGSN

**Table 10.2.2: UL-UNITDATA PDU content**

Information element	Type / Reference	Presence	Format	Length
PDU type	PDU type/11.3.26	M	V	1
TLLI	TLLI/11.3.35	M	V	4
QoS Profile	QoS Profile/11.3.28	M	V	3
Cell Identifier (note 5)	Cell Identifier/11.3.9	M	TLV	10
PFI	PFI/11.3.42	O	TLV	3
LSA Identifier List	LSA Identifier List/11.3.18	O	TLV	3-?
Redirect Attempt Flag (Note 3)	Redirect Attempt Flag/11.3.111	O	TLV	3
IMSI (note 2)	IMSI/11.3.14	O	TLV	5-10
Unconfirmed send state variable (note 4)	Unconfirmed send state variable/11.3.114	O	TLV	4
Selected PLMN ID (note 5)	Selected PLMN ID/11.3.118	O	TLV	5
Coverage Class (note 7)	Coverage Class/11.3.124	O	TLV	3
Exception Report Flag (note 6)	Exception Report Flag/11.3.126	O	TLV	3
Selected Operator (note 8, 9)	PLMN Identity/11.3.129	O	TLV	5
CS Registered Operator (note 8, 10)	PLMN Identity/11.3.129	O	TLV	5
Alignment octets	Alignment octets/11.3.1	O	TLV	2-5
LLC-PDU (note 1)	LLC-PDU/11.3.15	M	TLV	2-?
<p>NOTE 1: The LLC-PDU Length Indicator may be zero.</p> <p>NOTE 2: IMSI shall be included if available and if Redirect Attempt Flag is present.</p> <p>NOTE 3: This element indicates that the core network shall respond with either Redirection Indication IE or Redirection Completed IE in DL_UNITDATA</p> <p>NOTE 4: Unconfirmed send state variable shall be included if received in the previous DL_UNITDATA.</p> <p>NOTE 5: Selected PLMN ID shall be included in the case of a mobile station supporting network sharing when a foreign TLLI or a random TLLI is included in the UL-UNIDATA PDU; in such a case the Common PLMN ID shall be included within the Cell Identifier IE.</p> <p>NOTE 6: The exception report flag shall be included</p> <p>a) if the UL-UNITDATA PDU contains an LLC PDU sent by the MS using an uplink EC TBF established in response to an EC PACKET CHANNEL REQUEST message indicating high priority (i.e. an exception report).</p> <p>b) if the UL-UNITDATA PDU contains an LLC PDU sent by the MS using an uplink EC TBF established in response to an EC PACKET DOWNLINK ACK/NACK message including channel request and indicating high priority(i.e. an exception report).</p> <p>NOTE 7: The values indicated by this IE are the uplink and downlink coverage classes used by the mobile station in the access request initiating the transmission of the LLC-PDU included in the UL-UNITDATA PDU.</p> <p>NOTE 8: Only one of these two optional IEs shall be present in the message.</p> <p>NOTE 9: This IE indicates the BSS selected CN operator. It is only included if the BSS supports CS/PS coordination enhancements.</p> <p>NOTE 10: This IE is included if the BSS supports CS/PS coordination enhancements and if the mobile station is served by one of the shared CN operators in the CS domain.</p>				

### 10.2.3 RA-CAPABILITY

This PDU informs the BSS of the new Radio Access Capability of an MS.

PDU type: RA-CAPABILITY

Direction: SGSN to BSS

**Table 10.2.3: RA-CAPABILITY PDU content**

Information element	Type / Reference	Presence	Format	Length
PDU type	PDU type/11.3.26	M	V	1
TLLI	TLLI/11.3.35	M	TLV	6
MS Radio Access Capability	MS Radio Access Capability/11.3.22	M	TLV	7-?

## 10.2.4 (void)

## 10.2.5 DL-MBMS-UNITDATA

This PDU is sent to the BSS to transfer an LLC-PDU across the radio interface.

PDU type: DL-MBMS-UNITDATA

Direction: SGSN to BSS

**Table 10.2.5: DL-MBMS-UNITDATA PDU contents**

Information element	Type / Reference	Presence	Format	Length
PDU type	PDU type/11.3.26	M	V	1
PDU Lifetime	PDU Lifetime/11.3.25	M	TLV	4
TMGI	TMGI/ 11.3.77	M	TLV	3-8
MBMS Session Identity	MBMS Session Identity/ 11.3.71	O	TLV	3
Alignment octets	Alignment octets/11.3.1	O	TLV	2-5
LLC-PDU	LLC-PDU/11.3.15	M	TLV	3-?

## 10.2.6 UL-MBMS-UNITDATA

This PDU transfers an LLC-PDU for an MBMS session across the Gb-interface.

PDU type: UL-MBMS-UNITDATA

Direction: BSS to SGSN

**Table 10.2.6: UL-MBMS-UNITDATA PDU contents**

Information element	Type / Reference	Presence	Format	Length
PDU type	PDU type/11.3.26	M	V	1
TMGI	TMGI/ 11.3.77	M	TLV	3-8
MBMS Session Identity	MBMS Session Identity/ 11.3.71	O	TLV	3
Alignment octets	Alignment octets/11.3.1	O	TLV	2-5
LLC-PDU (note 1)	LLC-PDU/11.3.15	M	TLV	2-?
NOTE: The LLC-PDU Length Indicator shall be zero in this version of the specifications.				

## 10.3 PDU functional definitions and contents at GMM SAP

### 10.3.1 PAGING PS

This PDU indicates that a BSS shall initiate the packet paging procedure for an MS within a group of cells.

PDU type: PAGING-PS

Direction: SGSN to BSS

Table 10.3.1: PAGING PS PDU content

Information elements	Type / Reference	Presence	Format	Length
PDU type	PDU type/11.3.26	M	V	1
IMSI	IMSI/11.3.14	M	TLV	5 -10
DRX Parameters (note 3)	DRX Parameters/11.3.11	O	TLV	4
BVCI (note 1)	BVCI/11.3.6	C	TLV	4
Location Area (note 1)	Location Area/11.3.17	C (note 2)	TLV	7
Routeing Area (note 1)	Routeing Area/11.3.31	C (note 2)	TLV	8
BSS Area Indication (note 1)	BSS Area Indication/11.3.3	C	TLV	3
PFI	PFI/11.3.42	O	TLV	3
ABQP	ABQP/11.3.43	O	TLV	13-?
QoS Profile	QoS Profile/11.3.28	M	TLV	5
P-TMSI	TMSI/11.3.36	O	TLV	6
eDRX Parameters (note 3)	eDRX Parameters/11.3.122	O	TLV	3
Coverage Class	Coverage Class/11.3.124	O	TLV	3
Cell Identifier (note 4)	Cell Identifier/11.3.9	O	TLV	10
MS Radio Access Capability (note 5)	MS Radio Access Capability/11.3.22	O	TLV	7-?
Paging Attempt Information	Paging Attempt Information/11.3.125	O	TLV	3
<p>NOTE 1: One and only one of the conditional IEs shall be present. No repeated instances of the conditional IEs are permissible (e.g. one and only one Location Area shall be present).</p> <p>NOTE 2: When network sharing is supported, the PLMN included in the Location Area/ Routeing Area elements can be either the Common PLMN or an Additional PLMN (see 3GPP TS 44.018 [25]).</p> <p>NOTE 3: If the SGSN has valid eDRX Parameters for a TLLI it shall include the eDRX Parameters IE in which case the DRX Parameters IE shall not be included. For the case where PSM is enabled with eDRX and the Active timer is running the SGSN shall always include the negotiated eDRX value in the eDRX Parameters IE.</p> <p>NOTE 4: The cell identity for the cell where the Coverage Class was reported by the MS shall be included if available at the SGSN.</p> <p>NOTE 5: The field shall be present if there is valid MS Radio Access Capability information for the MS known by the SGSN; the field shall not be present otherwise.</p>				

## 10.3.2 PAGING CS

This PDU indicates that a BSS shall initiate a circuit-switched paging procedure for an MS within a group of cells.

PDU type: PAGING-CS

Direction: SGSN to BSS

**Table 10.3.2: PAGING CS PDU content**

Information elements	Type / Reference	Presence	Format	Length
PDU type	PDU type/11.3.26	M	V	1
IMSI	IMSI/11.3.14	M	TLV	5 -10
DRX Parameters	DRX Parameters/11.3.11	M	TLV	4
BVCI (note 1)	BVCI/11.3.6	C	TLV	4
Location Area (note 1)	Location Area/11.3.17	C (note 3)	TLV	7
Routeing Area (note 1)	Routeing Area/11.3.31	C (note 3)	TLV	8
BSS Area Indication (note 1)	BSS Area Indication/11.3.3	C	TLV	3
TLLI	TLLI/11.3.35	O	TLV	6
Channel needed (note 2)	Channel needed/11.3.10	O	TLV	3
eMLPP-Priority (note 2)	eMLPP-Priority/11.3.12	O	TLV	3
TMSI (note 2)	TMSI/11.3.36	O	TLV	6
Global CN-Id (note 2)	Global CN-Id/11.3.69	O	TLV	7
NOTE 1: One and only one of the conditional IEs shall be present. No repeated instances of the conditional IEs are permissible (e.g. one and only one Location Area shall be present).				
NOTE 2: These fields are provided by the MSC via the Gs-Interface.				
NOTE 3: When network sharing is supported, the PLMN included in the Location Area/Routeing Area elements can be either the Common PLMN or an Additional PLMN (see 3GPP TS 44.018 [25]).				

## 10.3.3 RA-CAPABILITY-UPDATE

This PDU requests that the SGSN send an MS's current Radio Access capability or IMSI to the BSS.

PDU type: RA-CAPABILITY-UPDATE

Direction: BSS to SGSN

**Table 10.3.3: RA-CAPABILITY-UPDATE PDU content**

Information element	Type / Reference	Presence	Format	Length
PDU type	PDU type/11.3.26	M	V	1
TLLI	TLLI/11.3.35	M	TLV	6
Tag	Tag/11.3.34	M	TLV	3

## 10.3.4 RA-CAPABILITY-UPDATE-ACK

This PDU provides the BSS with an MS's current Radio Access capability and IMSI.

PDU type: RA-CAPABILITY-UPDATE-ACK

Direction: SGSN to BSS

**Table 10.3.4: RA-CAPABILITY-UPDATE-ACK PDU content**

Information element	Type / Reference	Presence	Format	Length
PDU type	PDU type/11.3.26	M	V	1
TLLI	TLLI/11.3.35	M	TLV	6
Tag	Tag/11.3.34	M	TLV	3
IMSI (note)	IMSI/11.3.14	C	TLV	5 -10
RA-Cap-UPD-CAUSE	RA-Cap-UPD-CAUSE/11.3.30	M	TLV	3
MS Radio Access Capability	MS Radio Access Capability/11.3.22	C	TLV	7-?
NOTE: If RA-Cap-UPD-CAUSE is not set to "OK", then neither the MS Radio Access Capability nor the IMSI shall be present. Otherwise, the IMSI shall be present.				

## 10.3.5 RADIO-STATUS

This PDU indicates that an exception condition related to the radio interface has occurred.

PDU type: RADIO-STATUS

Direction: BSS to SGSN

**Table 10.3.5: RADIO-STATUS PDU content**

Information elements	Type / Reference	Presence	Format	Length
PDU type	PDU type/11.3.26	M	V	1
TLLI (note)	TLLI/11.3.35	C	TLV	6
TMSI (note)	TMSI/11.3.36	C	TLV	6
IMSI (note)	IMSI/11.3.14	C	TLV	5-10
Radio Cause	Radio Cause/11.3.29	M	TLV	3
NOTE: One and only one of the conditional IEs shall be present.				

## 10.3.6 SUSPEND

This PDU indicates that an MS wishes to suspend its GPRS service.

PDU type: SUSPEND

Direction: BSS to SGSN

**Table 10.3.6: SUSPEND PDU content**

Information elements	Type / Reference	Presence	Format	Length
PDU type	PDU type/11.3.26	M	V	1
TLLI	TLLI/11.3.35	M	TLV	6
Routeing Area	Routeing Area/11.3.31	M	TLV	8

## 10.3.7 SUSPEND-ACK

This PDU positively acknowledges the reception of a SUSPEND PDU for an MS.

PDU type: SUSPEND-ACK

Direction: SGSN to BSS

**Table 10.3.7: SUSPEND-ACK PDU content**

Information elements	Type / Reference	Presence	Format	Length
PDU type	PDU type/11.3.26	M	V	1
TLLI	TLLI/11.3.35	M	TLV	6
Routeing Area	Routeing Area/11.3.31	M	TLV	8
Suspend Reference Number	Suspend Reference Number/11.3.33	M	TLV	3

## 10.3.8 SUSPEND-NACK

This PDU negatively acknowledges the reception of a SUSPEND PDU for an MS.

PDU type: SUSPEND-NACK

Direction: SGSN to BSS

**Table 10.3.8: SUSPEND-NACK PDU content**

Information elements	Type / Reference	Presence	Format	Length
PDU type	PDU type/11.3.26	M	V	1
TLLI	TLLI/11.3.35	M	TLV	6
Routeing Area	Routeing Area/11.3.31	M	TLV	8
Cause	Cause/11.3.8	O	TLV	3

## 10.3.9 RESUME

This PDU indicates that an MS wishes to RESUME its GPRS service.

PDU type: RESUME

Direction: BSS to SGSN

**Table 10.3.9: RESUME PDU content**

Information elements	Type / Reference	Presence	Format	Length
PDU type	PDU type/11.3.26	M	V	1
TLLI	TLLI/11.3.35	M	TLV	6
Routeing Area	Routeing Area/11.3.31	M	TLV	8
Suspend Reference Number	Suspend Reference Number/11.3.33	M	TLV	3

### 10.3.10 RESUME-ACK

This PDU positively acknowledges the reception of a RESUME PDU for an MS.

PDU type: RESUME-ACK

Direction: SGSN to BSS

**Table 10.3.10: RESUME-ACK PDU content**

Information elements	Type / Reference	Presence	Format	Length
PDU type	PDU type/11.3.26	M	V	1
TLLI	TLLI/11.3.35	M	TLV	6
Routeing Area	Routeing Area/11.3.31	M	TLV	8

### 10.3.11 RESUME-NACK

This PDU negatively acknowledges the reception of a RESUME PDU for an MS.

PDU type: RESUME-NACK

Direction: SGSN to BSS

**Table 10.3.11: RESUME-NACK PDU content**

Information elements	Type / Reference	Presence	Format	Length
PDU type	PDU type/11.3.26	M	V	1
TLLI	TLLI/11.3.35	M	TLV	6
Routeing Area	Routeing Area/11.3.31	M	TLV	8
Cause	Cause/11.3.8	O	TLV	3

### 10.3.12 DUMMY PAGING PS

This PDU indicates that a BSS shall calculate the time until the next paging occasion for the MS indicated in the message.

PDU type: DUMMY-PAGING-PS

Direction: SGSN to BSS

**Table 10.3.12: DUMMY PAGING PS PDU content**

Information elements	Type / Reference	Presence	Format	Length
PDU type	PDU type/11.3.26	M	V	1
IMSI	IMSI/11.3.14	M	TLV	5 -10
Routeing Area	Routeing Area/11.3.31	O	TLV	8
eDRX Parameters	eDRX Parameters/11.3.122	O	TLV	3



### 10.3.13 DUMMY PAGING PS RESPONSE

This PDU provides the SGSN with the time until the next paging occasion for the MS indicated in the message.

PDU type: DUMMY-PAGING-PS-RESPONSE

Direction: BSS to SGSN

**Table 10.3.13: DUMMY PAGING PS RESPONSE PDU content**

Information elements	Type / Reference	Presence	Format	Length
PDU type	PDU type/11.3.26	M	V	1
IMSI	IMSI/11.3.14	M	TLV	5 -10
Time Until Next Paging Occasion	Time Until Next Paging Occasion/11.3.123	M	TLV	3

### 10.3.14 PAGING PS REJECT

This PDU indicates that a BSS has determined the nominal paging group of the MS occurs too far into the future.

PDU type: PAGING-PS-PDU

Direction: BSS to SGSN

**Table 10.3.14: PAGING PS REJECT PDU content**

Information elements	Type / Reference	Presence	Format	Length
PDU type	PDU type/11.3.26	M	V	1
IMSI	IMSI/11.3.14	M	TLV	5 -10
P-TMSI (note 1)	TMSI/11.3.36	O	TLV	6
Time Until Next Paging Occasion	Time Until Next Paging Occasion/11.3.123	M	TLV	3
NOTE 1: Included if present in the corresponding PAGING-PS PDU.				

### 10.3.15 MS REGISTRATION ENQUIRY

This PDU allows the BSS to request registration information for a given mobile station. It is used in MOCN and GWCN configurations for network sharing.

PDU type: MS-REGISTRATION-ENQUIRY

Direction: BSS to SGSN

**Table 10.3.15: MS REGISTRATION ENQUIRY PDU content**

Information elements	Type / Reference	Presence	Format	Length
PDU type	PDU type/11.3.26	M	V	1
IMSI	IMSI/11.3.14	M	TLV	5-10
MME Query	MME Query/11.3.130	O	TLV	3

### 10.3.16 MS REGISTRATION ENQUIRY RESPONSE

This PDU is sent to the BSS to provide registration information for a given mobile station. It is used in MOCN and GWCN configurations for network sharing.

PDU type: MS-REGISTRATION-ENQUIRY-RESPONSE

Direction: SGSN to BSS

**Table 10.3.16: MS REGISTRATION ENQUIRY RESPONSE PDU content**

Information elements	Type / Reference	Presence	Format	Length
PDU type	PDU type/11.3.26	M	V	1
IMSI	IMSI/11.3.14	M	TLV	5-10
PS Registered Operator (note 1)	PLMN Identity/11.3.129	O	TLV	5
NOTE 1: This IE identifies the serving CN operator for the mobile station associated to the IMSI. Omitting this IE from the message has the significance of no serving CN operator for the mobile station (IMSI).				

## 10.4 PDU functional definitions and contents at NM SAP

### 10.4.1 FLUSH-LL

This PDU informs a BSS that an MS has moved from one cell to another.

PDU type: FLUSH-LL

Direction: SGSN to BSS

**Table 10.4.1: FLUSH-LL PDU content**

Information elements	Type / Reference	Presence	Format	Length
PDU type	PDU type/11.3.26	M	V	1
TLLI	TLLI/11.3.35	M	TLV	6
BVCI (old)	BVCI/11.3.6	M	TLV	4
BVCI (new)	BVCI/11.3.6	O	TLV	4
NSEI (new)	NSEI/11.3.48	O (note)	TLV	4
NOTE: NSEI (new) is included if the SGSN supports "Inter-NSE re-routing" or "LCS Procedures" and the old NSE supports the "Inter-NSE re-routing" or "LCS Procedures" and the cell change is an Inter-NSE cell change within a routing area.				

### 10.4.2 FLUSH-LL-ACK

This PDU indicates that LLC-PDU(s) buffered for an MS in the old cell have been either deleted or transferred to the new cell within the routing area.

PDU type: FLUSH-LL-ACK

Direction: BSS to SGSN

**Table 10.4.2: FLUSH-LL-ACK PDU content**

Information elements	Type / Reference	Presence	Format	Length
PDU type	PDU type/11.3.26	M	V	1
TLLI	TLLI/11.3.35	M	TLV	6
Flush Action	Flush Action/11.3.13	M	TLV	3
BVCI (new)	BVCI/11.3.13	C (note 1)	TLV	4
Number of octets affected	Number of octets affected/11.3.41	M	TLV	5
NSEI (new)	NSEI/11.3.48	C (note 2)	TLV	4
NOTE 1: BVCI (new) is included only if Flush action indicated that LLC-PDUs are transferred. NOTE 2: NSEI (new) is included only if BVCI(new) is included and NSEI (new) is received in the FLUSH-LL PDU.				

### 10.4.3 LLC-DISCARDED

This PDU indicates that a number of buffered LLC-PDUs in a cell for an MS have been deleted inside the BSS (because of PDU Lifetime expiration or radio outage for example). The LLC frames and the related octets deleted by the BSS as a consequence of a FLUSH-LL procedure (see sub-clause 8.1) shall not be reported a second time by means of an LLC-DISCARDED PDU.

PDU type: LLC-DISCARDED

Direction: BSS to SGSN

**Table 10.4.3: LLC-DISCARDED PDU content**

Information elements	Type / Reference	Presence	Format	Length
PDU type	PDU type/11.3.26	M	V	1
TLLI	TLLI/11.3.35	M	TLV	6
LLC Frames Discarded	LLC Frames Discarded/11.3.16	M	TLV	3
BVCI	BVCI/11.3.6	M	TLV	4
Number of octets deleted	Number of octets affected/11.3.41	M	TLV	5
PFI (note)	PFI/11.3.42	O	TLV	3
NOTE: The PFI may be provided in case the PFC flow control feature is negotiated. It corresponds to the Packet Flow Identifier of the PFC for which LLC frames have been discarded.				

### 10.4.4 FLOW-CONTROL-BVC

This PDU informs the flow control mechanism at an SGSN of the status of a BVC's maximum acceptable SGSN to BSS throughput on the Gb interface.

PDU type: FLOW-CONTROL-BVC

Direction: BSS to SGSN

**Table 10.4.4: FLOW-CONTROL-BVC PDU content**

Information elements	Type / Reference	Presence	Format	Length
PDU type	PDU type/11.3.26	M	V	1
Tag	Tag/11.3.34	M	TLV	3
BVC Bucket Size	BVC Bucket Size/11.3.5	M	TLV	4
Bucket Leak Rate	Bucket Leak Rate/11.3.4	M	TLV	4
Bmax default MS	Bmax default MS/11.3.2	M	TLV	4
R_default_MS	R_default_MS/11.3.32	M	TLV	4
Bucket_Full Ratio	Bucket_Full Ratio/11.3.46	C	TLV	3
BVC Measurement	BVC Measurement/11.3.7	O	TLV	4
Flow Control Granularity (note)	Flow Control Granularity/11.3.102	O	TLV	3
NOTE: The Flow Control Granularity shall be provided in case the Gigabit Interface feature is negotiated.				

### 10.4.5 FLOW-CONTROL-BVC-ACK

This PDU informs the flow control mechanism at the BSS that the SGSN has received the FLOW-CONTROL-BVC PDU indicated by the Tag.

PDU type: FLOW-CONTROL-BVC-ACK

Direction: SGSN to BSS

**Table 10.4.5: FLOW-CONTROL-BVC-ACK PDU content**

Information elements	Type / Reference	Presence	Format	Length
----------------------	------------------	----------	--------	--------

PDU type	PDU type/11.3.26	M	V	1
Tag	Tag/11.3.34	M	TLV	3

## 10.4.6 FLOW-CONTROL-MS

This PDU informs the flow control mechanism at an SGSN of the status of an MS's maximum acceptable SGSN to BSS throughput on the Gb interface.

PDU type: FLOW-CONTROL-MS

Direction: BSS to SGSN

**Table 10.4.6: FLOW-CONTROL-MS PDU content**

Information elements	Type / Reference	Presence	Format	Length
PDU type	PDU type/11.3.26	M	V	1
TLLI	TLLI/11.3.35	M	TLV	6
Tag	Tag/11.3.34	M	TLV	3
MS Bucket Size	MS Bucket Size/11.3.21	M	TLV	4
Bucket Leak rate	Bucket Leak rate/11.3.4	M	TLV	4
Bucket_Full Ratio	Bucket_Full Ratio/11.3.46	C	TLV	3
Flow Control Granularity (note)	Flow Control Granularity/11.3.102	O	TLV	3
NOTE: The Flow Control Granularity shall be provided in case the Gigabit Interface feature is negotiated.				

## 10.4.7 FLOW-CONTROL-MS-ACK

This PDU informs the flow control mechanism at the BSS that the SGSN has received the FLOW-CONTROL-MS PDU indicated by the TLLI and the Tag.

PDU type: FLOW-CONTROL-MS-ACK

Direction: SGSN to BSS

**Table 10.4.7: FLOW-CONTROL-MS-ACK PDU content**

Information elements	Type / Reference	Presence	Format	Length
PDU type	PDU type/11.3.26	M	V	1
TLLI	TLLI/11.3.35	M	TLV	6
Tag	Tag/11.3.34	M	TLV	3

## 10.4.8 BVC-BLOCK

This PDU indicates that the contained BVC shall be blocked at the recipient entity.

PDU type: BVC-BLOCK

Direction: BSS to SGSN

**Table 10.4.8: BVC-BLOCK PDU content**

Information elements	Type / Reference	Presence	Format	Length
PDU type	PDU type/11.3.26	M	V	1
BVCI	BVCI/11.3.6	M	TLV	4
Cause	Cause/11.3.8	M	TLV	3

## 10.4.9 BVC-BLOCK-ACK

This PDU acknowledges that a BVC has been blocked.

PDU type: BVC-BLOCK-ACK

Direction: SGSN to BSS

**Table 10.4.9: BVC-BLOCK-ACK PDU content**

Information elements	Type / Reference	Presence	Format	Length
PDU type	PDU type/11.3.26	M	V	1
BVCI	BVCI/11.3.6	M	TLV	4

## 10.4.10 BVC-UNBLOCK

This PDU indicates that the identified BVC shall be unblocked at the recipient entity.

PDU type: BVC-UNBLOCK

Direction: BSS to SGSN

**Table 10.4.10: BVC-UNBLOCK PDU content**

Information elements	Type / Reference	Presence	Format	Length
PDU type	PDU type/11.3.26	M	V	1
BVCI	BVCI/11.3.6	M	TLV	4

## 10.4.11 BVC-UNBLOCK-ACK

This PDU acknowledges that a BVC has been unblocked.

PDU type: BVC-UNBLOCK-ACK

Direction: SGSN to BSS

**Table 10.4.11: BVC-UNBLOCK-ACK PDU content**

Information elements	Type / Reference	Presence	Format	Length
PDU type	PDU type/11.3.26	M	V	1
BVCI	BVCI/11.3.6	M	TLV	4

## 10.4.12 BVC-RESET

This PDU indicates that BVC initialisation is required, e.g. because of a BVC failure.

PDU type: BVC-RESET

Direction: SGSN to BSS, BSS to SGSN

**Table 10.4.12: BVC-RESET PDU content**

Information elements	Type / Reference	Presence	Format	Length
PDU type	PDU type/11.3.26	M	V	1
BVCI	BVCI/11.3.6	M	TLV	4
Cause	Cause/11.3.8	M	TLV	3
Cell Identifier (note 1)		C	TLV	10
Feature bitmap (note 2)	Feature bitmap/11.3.45	O	TLV	3
Extended Feature Bitmap (note 3)	Extended Feature Bitmap/11.3.84	O	TLV	3
NOTE 1: The Cell Identifier IE is mandatory in the BVC-RESET PDU sent from BSS to SGSN in order to reset a BVC corresponding to a PTP functional entity. The Cell Identifier IE shall not be used in any other BVC-RESET PDU.				
NOTE 2: The Feature bitmap is only sent in a BVC-RESET PDU related to the signalling BVC. Absence of this IE implies no optional features are available over the NSE.				
NOTE 3: The Extended Feature Bitmap is only sent in a BVC-RESET PDU related to the signalling BVC.				

## 10.4.13 BVC-RESET-ACK

This PDU indicates that BVC initialisation has been executed.

PDU type: BVC-RESET-ACK

Direction: BSS to SGSN, SGSN to BSS

**Table 10.4.13: BVC-RESET-ACK PDU content**

Information elements	Type / Reference	Presence	Format	Length
PDU type	PDU type/11.3.26	M	V	1
BVCI	BVCI/11.3.6	M	TLV	4
Cell Identifier (note 1)		C	TLV	10
Feature bitmap (note 2)	Feature bitmap/11.3.45	O	TLV	3
Extended Feature Bitmap (note 3)	Extended Feature Bitmap/11.3.84	O	TLV	3
NOTE 1: The Cell Identifier IE is mandatory in the BVC-RESET-ACK PDU sent from BSS to SGSN in response to reset a BVC corresponding to a PTP functional entity. The Cell Identifier IE shall not be used in any other BVC-RESET-ACK PDU.				
NOTE 2: The Feature bitmap is only sent in a BVC-RESET-ACK PDU related to the signalling BVC. Absence of this IE implies no optional features are available over the NSE.				
NOTE 3: The Extended Feature Bitmap is only sent in a BVC-RESET-ACK PDU related to the signalling BVC.				

## 10.4.14 STATUS

This PDU indicates that an exception condition occurred.

PDU type: STATUS

Direction: SGSN to BSS, BSS to SGSN

**Table 10.4.14: STATUS PDU content**

Information elements	Type / Reference	Presence	Format	Length
PDU type	PDU type/11.3.26	M	V	1
Cause	Cause/11.3.8	M	TLV	3
BVCI	BVCI/11.3.6	C	TLV	4
PDU In Error (note)	PDU In Error/11.3.24	O	TLV	3-?
NOTE: This is the whole PDU (starting with the [PDU type]) within which an error was detected. This PDU may be truncated if it exceeds the information carrying capacity of the underlying network service.				

### 10.4.14.1 Static conditions for BVCI

The "BVCI" IE shall be included when the "Cause" IE is set to one of the following values:

- a) "BVCI blocked";
- b) "BVCI unknown";

and shall not be included otherwise.

## 10.4.15 SGSN-INVOKE-TRACE

This PDU indicates that the BSS shall begin the production of a trace record for an MS.

PDU type: SGSN-INVOKE-TRACE

Direction: SGSN to BSS

**Table 10.4.15: SGSN-INVOKE-TRACE PDU content**

Information elements	Type / Reference	Presence	Format	Length
PDU type	PDU type/11.3.26	M	V	1
Trace Type	Trace Type/11.3.38	M	TLV	3
Trace Reference	Trace Reference/11.3.37	M	TLV	4
Trigger Id	Trigger Id/11.3.40	O	TLV	4-24
Mobile Id	Mobile Id/11.3.20	O	TLV	3-10
OMC Id	OMC Id/11.3.23	O	TLV	4-24
TransactionId	TransactionId/11.3.39	O	TLV	4

## 10.4.16 DOWNLOAD-BSS-PFC

This PDU requests a SGSN to initiate a CREATE-BSS-PFC procedure.

PDU type: DOWNLOAD-BSS-PFC

Direction: BSS to SGSN

**Table 10.4.16: DOWNLOAD-BSS-PFC PDU content**

Information elements	Type / Reference	Presence	Format	Length
PDU type	PDU type/11.3.26	M	V	1
TLLI	TLLI/11.3.35	M	TLV	6
PFI	PFI/11.3.42	M	TLV	3

## 10.4.17 CREATE-BSS-PFC

This PDU allows the SGSN to request that a BSS create or modify a BSS Packet Flow Context.

PDU type: CREATE-BSS-PFC

Direction: SGSN to BSS

**Table 10.4.17: CREATE-BSS-PFC PDU content**

Information elements	Type / Reference	Presence	Format	Length
PDU type	PDU type/11.3.26	M	V	1
TLLI	TLLI/11.3.35	M	TLV	6
IMSI	IMSI/11.3.14	O (note 4)	TLV	5 -10
PFI	PFI/11.3.42	M	TLV	3
PFT	GPRS Timer/11.3.44	M	TLV	3
ABQP	ABQP/11.3.43	M	TLV	13-?
Service UTRAN CCO	Service UTRAN CCO/11.3.47	O	TLV	3
MS Radio Access Capability	MS Radio Access Capability/11.3.22	O (note 1)	TLV	7-?
Allocation/Retention Priority	Priority/11.3.27	O	TLV	3
T10	GPRS Timer/11.3.44	C (note 2)	TLV	3
Inter RAT Handover Info	Inter RAT Handover Info/11.3.94	O (note 3)	TLV	3-?
E-UTRAN Inter RAT Handover Info	E-UTRAN Inter RAT Handover Info/11.3.104	O (note 3)	TLV	3-?
Subscriber Profile ID for RAT/Frequency priority (note 5)	Subscriber Profile ID for RAT/Frequency priority/11.3.105	O	TLV	3
NOTE 1: This Information Element shall be present if there is valid MS Radio Access Capability information known by the SGSN. NOTE 2: This information element shall be present if the Allocation/Retention Priority IE is present and if queuing is allowed for the PFC. NOTE 3: This information element shall be present if available in the SGSN. NOTE 4: This information element shall be present if the IMSI is available in the SGSN. NOTE 5: This IE may be included if available in the SGSN. If the Service UTRAN CCO IE is present with the value of "shall not" the Service UTRAN CCO IE takes precedence over this IE.				

## 10.4.18 CREATE-BSS-PFC-ACK

This PDU allows the BSS to acknowledge a request from the SGSN for the creation or modification of a BSS Packet Flow Context.

PDU type: CREATE-BSS-PFC-ACK



Direction: BSS to SGSN

**Table 10.4.18: CREATE-BSS-PFC-ACK PDU content**

Information elements	Type / Reference	Presence	Format	Length
PDU type	PDU type/11.3.26	M	V	1
TLLI	TLLI/11.3.35	M	TLV	6
PFI	PFI/11.3.42	M	TLV	3
ABQP	ABQP/11.3.43	M	TLV	13-?
Cause	Cause/11.3.8	O	TLV	3

## 10.4.19 CREATE-BSS-PFC-NACK

This PDU allows the BSS to Nack a request from the SGSN for the creation of a BSS Packet Flow Context.

PDU type: CREATE-BSS-PFC-NACK

Direction: BSS to SGSN

**Table 10.4.19: CREATE-BSS-PFC-NACK PDU content**

Information elements	Type / Reference	Presence	Format	Length
PDU type	PDU type/11.3.26	M	V	1
TLLI	TLLI/11.3.35	M	TLV	6
PFI	PFI/11.3.42	M	TLV	3
Cause	Cause/11.3.8	M	TLV	3

## 10.4.20 MODIFY-BSS-PFC

This PDU allows the BSS to request a modification of a BSS Packet Flow Context.

PDU type: MODIFY-BSS-PFC

Direction: BSS to SGSN

**Table 10.4.20: MODIFY-BSS-PFC PDU content**

Information elements	Type / Reference	Presence	Format	Length
PDU type	PDU type/11.3.26	M	V	1
TLLI	TLLI/11.3.35	M	TLV	6
PFI	PFI/11.3.42	M	TLV	3
ABQP	ABQP/11.3.43	M	TLV	13-?

## 10.4.21 MODIFY-BSS-PFC-ACK

This PDU allows the SGSN to acknowledge a modification to a BSS Packet Flow Context.

PDU type: MODIFY-BSS-PFC-ACK

Direction: SGSN to BSS

**Table 10.4.21: MODIFY-BSS-PFC-ACK PDU content**

Information elements	Type / Reference	Presence	Format	Length
----------------------	------------------	----------	--------	--------

PDU type	PDU type/11.3.26	M	V	1
TLLI	TLLI/11.3.35	M	TLV	6
PFI	PFI/11.3.42	M	TLV	3
PFT	GPRS Timer/11.3.44	M	TLV	3
ABQP	ABQP/11.3.43	M	TLV	13-?

## 10.4.22 DELETE-BSS-PFC

This PDU allows the SGSN to request that a BSS delete a BSS Packet Flow Context.

PDU type: DELETE-BSS-PFC

Direction: SGSN to BSS

**Table 10.4.22: DELETE-BSS-PFC PDU content**

Information elements	Type / Reference	Presence	Format	Length
PDU type	PDU type/11.3.26	M	V	1
TLLI	TLLI/11.3.35	M	TLV	6
PFI	PFI/11.3.42	M	TLV	3

## 10.4.23 DELETE-BSS-PFC-ACK

This PDU allows the BSS to acknowledge a request for the deletion of a BSS Packet Flow Context.

PDU type: DELETE-BSS-PFC-ACK

Direction: BSS to SGSN

**Table 10.4.23: DELETE-BSS-PFC-ACK PDU content**

Information elements	Type / Reference	Presence	Format	Length
PDU type	PDU type/11.3.26	M	V	1
TLLI	TLLI/11.3.35	M	TLV	6
PFI	PFI/11.3.42	M	TLV	3

## 10.4.24 FLOW-CONTROL-PFC

This PDU provides the SGSN with flow control information regarding one or more PFC(s) of a given Mobile Station.

PDU type: FLOW-CONTROL-PFC

Direction: BSS to SGSN

**Table 10.4.24: FLOW-CONTROL-PFC PDU content**

Information elements	Type / Reference	Presence	Format	Length
PDU type	PDU type/11.3.26	M	V	1
TLLI	TLLI/11.3.35	M	TLV	6
Tag	Tag/11.3.34	M	TLV	3
MS Bucket Size	MS Bucket Size/11.3.21	O	TLV	4
Bucket Leak rate	Bucket Leak rate/11.3.4	O	TLV	4
Bucket_Full Ratio	Bucket_Full Ratio/11.3.46	O	TLV	3
PFC flow control parameters	PFC flow control parameters/11.3.68	M	TLV	
Flow Control Granularity (note)	Flow Control Granularity/11.3.102	O	TLV	3
NOTE: The Flow Control Granularity shall be provided in case the Gigabit Interface feature is negotiated.				

## 10.4.25 FLOW-CONTROL-PFC-ACK

This PDU informs the flow control mechanism at the BSS that the SGSN has received the FLOW-CONTROL-PFC PDU indicated by the TLLI and the Tag.

PDU type: FLOW-CONTROL-PFC-ACK

Direction: SGSN to BSS

**Table 10.4.25: FLOW-CONTROL-PFC-ACK PDU content**

Information elements	Type / Reference	Presence	Format	Length
PDU type	PDU type/11.3.26	M	V	1
TLLI	TLLI/11.3.35	M	TLV	6
Tag	Tag/11.3.34	M	TLV	3

## 10.4.26 DELETE-BSS-PFC-REQ

This PDU allows the BSS to inform the SGSN that the BSS Packet Flow Context cannot be supported anymore

PDU type: DELETE-BSS-PFC-REQ

Direction: BSS to SGSN

**Table 10.4.26: DELETE-BSS-PFC-REQ PDU content**

Information elements	Type / Reference	Presence	Format	Length
PDU type	PDU type/11.3.26	M	V	1
TLLI	TLLI/11.3.35	M	TLV	6
PFI	PFI/11.3.42	M	TLV	3
Cause	Cause/11.3.8	M	TLV	3

## 10.4.27 PS-HANDOVER-REQUIRED

This PDU initiates the allocation of resources in the target system for an MS.

PDU type: PS-HANDOVER-REQUIRED

Direction: BSS to SGSN

**Table 10.4.27: PS-HANDOVER-REQUIRED PDU content**

Information elements	Type / Reference	Presence	Format	Length
----------------------	------------------	----------	--------	--------

PDU type	PDU type/11.3.26	M	V	1
TLLI	TLLI/11.3.35	M	TLV	6
Cause	Cause/11.3.8	M	TLV	3
Source Cell Identifier	Cell Identifier/11.3.9	M	TLV	10
Target Cell Identifier (note 2)	Cell Identifier/11.3.9	C	TLV	10
Source BSS to Target BSS Transparent Container (note 1)	Source BSS to Target BSS Transparent Container/11.3.79	C	TLV	10-?
Target RNC Identifier (note 2) (note 3)	RNC Identifier/11.3.87	C	TLV	10
Source to Target Transparent Container (note 1)	Source to Target Transparent Container/11.3.85	C	TLV	3-?
Active PFCs List	Active PFCs List/11.3.95c	M	TLV	3-?
Target eNB identifier (note 2) (note 3)	eNB Identifier/11.3.103	C	TLV	3-n
Reliable Inter RAT Handover Info (note 4)	Reliable Inter RAT Handover Info/11.3.107	C	TLV	3
CSG Identifier (note 5)	CSG Identifier/11.3.109	C	TLV	7
TAC (note 6)	Tracking Area Code/11.3.110	C	TLV	5
NOTE 1: One and only one of these two conditional IEs shall be present depending on the target RAT as specified in subclause 8a.4.				
NOTE 2: One and only one of these three conditional IEs shall be present depending on the target RAT as specified in subclause 8a.4.				
NOTE 3: In case of PS handover to E-UTRAN, the Target RNC Identifier IE (carrying the Corresponding RNC-ID) may be present as an alternative to the Target eNB identifier IE.				
NOTE 4: This IE shall be present when the target cell is a GERAN cell.				
NOTE 5: This IE shall be present when the target cell is a CSG or hybrid cell.				
NOTE 6: This IE shall be present when the target cell is a E-UTRAN CSG or hybrid cell.				

## 10.4.28 PS-HANDOVER-REQUIRED-ACK

This PDU indicates that resources have been allocated in the target system and that the BSS may initiate the channel change attempt for the corresponding MS.

PDU type: PS-HANDOVER-REQUIRED-ACK

Direction: SGSN to BSS

**Table 10.4.28: PS-HANDOVER-REQUIRED-ACK PDU content**

Information elements	Type / Reference	Presence	Format	Length
PDU type	PDU type/11.3.26	M	V	1
TLLI	TLLI/11.3.35	M	TLV	6
List of set-up PFCs	List of set-up PFCs/11.3.83	M	TLV	3-?
Target BSS to Source BSS Transparent Container (note)	Target BSS to Source BSS Transparent Container/11.3.80	C	TLV	3-?
Target to Source Transparent Container (note)	Target to Source Transparent Container/11.3.86	C	TLV	3-?
NOTE: One and only one of these two conditional IEs shall be present depending on the target RAT as specified in subclause 8a.4.				

## 10.4.29 PS-HANDOVER-REQUIRED-NACK

This PDU informs the source BSS about failed resource allocation in the target system.

PDU type: PS-HANDOVER-REQUIRED-NACK

Direction: SGSN to BSS

**Table 10.4.29: PS-HANDOVER-REQUIRED-NACK PDU content**

Information elements	Type / Reference	Presence	Format	Length
PDU type	PDU type/11.3.26	M	V	1
TLLI	TLLI/11.3.35	M	TLV	6
Cause	Cause/11.3.8	M	TLV	3

### 10.4.30 PS-HANDOVER-REQUEST

This PDU initiates the allocation of resources for one or more PFCs in the target BSS for an MS.

PDU type: PS-HANDOVER-REQUEST

Direction: SGSN to BSS

**Table 10.4.30: PS-HANDOVER-REQUEST PDU content**

Information elements	Type / Reference	Presence	Format	Length
PDU type	PDU type/11.3.26	M	V	1
TLLI	TLLI/11.3.35	M	TLV	6
IMSI	IMSI/11.3.14	M	TLV	5-10
Cause	Cause/11.3.8	M	TLV	3
Source Cell Identifier (note 1)	Cell Identifier/11.3.9	C	TLV	10
Source RNC Identifier (note 1)	RNC Identifier/11.3.87	C	TLV	10
Target Cell Identifier	Cell Identifier/11.3.9	M	TLV	10
Source BSS to Target BSS Transparent Container	Source BSS to Target BSS Transparent Container/11.3.79	M	TLV	7-?
PFCs to be set-up list	PFCs to be set-up list/11.3.82	M	TLV	22-?
NAS container for PS Handover	NAS container for PS Handover/11.3.81	O	TLV	3-?
Service UTRAN CCO	Service UTRAN CCO/11.3.47	O	TLV	3
Subscriber Profile ID for RAT/Frequency priority (note 2)	Subscriber Profile ID for RAT/Frequency priority /11.3.105	O	TLV	3
Reliable Inter RAT Handover Info (note 3)	Reliable Inter RAT Handover Info/11.3.107	C	TLV	3
NOTE 1: In case of PS handover from GERAN or UTRAN, one and only one of these two conditional IEs shall be present depending on the source RAT. In case of PS handover from E-UTRAN, neither of these two conditional IEs shall be present.				
NOTE 2: This IE may be included if available in the SGSN. If the Service UTRAN CCO IE is present with the value of "shall not" the Service UTRAN CCO IE takes precedence over this IE.				
NOTE 3: This IE shall be included if sent by the source BSS.				

### 10.4.31 PS-HANDOVER-REQUEST-ACK

This PDU acknowledges the successful allocation of resources in the target BSS.

PDU type: PS-HANDOVER-REQUEST-ACK

Direction: BSS to SGSN

**Table 10.4.31: PS-HANDOVER-REQUEST-ACK PDU content**

Information elements	Type / Reference	Presence	Format	Length
----------------------	------------------	----------	--------	--------

PDU type	PDU type/11.3.26	M	V	1
TLLI	TLLI/11.3.35	M	TLV	6
List of set-up PFCs	List of set-up PFCs/11.3.83	M	TLV	3-?
Target BSS to Source BSS Transparent Container	Target BSS to Source BSS Transparent Container/11.3.80	M	TLV	3-?

### 10.4.32 PS-HANDOVER-REQUEST-NACK

This PDU informs the SGSN about failed resource allocation in the target BSS.

PDU type: PS-HANDOVER-REQUEST-NACK

Direction: BSS to SGSN

**Table 10.4.32: PS-HANDOVER-REQUEST-NACK PDU content**

Information elements	Type / Reference	Presence	Format	Length
PDU type	PDU type/11.3.26	M	V	1
TLLI	TLLI/11.3.35	M	TLV	6
Cause	Cause/11.3.8	M	TLV	3

### 10.4.33 PS-HANDOVER-COMPLETE

This PDU informs the SGSN about successful channel change for an MS.

PDU type: PS-HANDOVER-COMPLETE

Direction: BSS to SGSN

**Table 10.4.33: PS-HANDOVER-COMPLETE PDU content**

Information elements	Type / Reference	Presence	Format	Length
PDU type	PDU type/11.3.26	M	V	1
TLLI	TLLI/11.3.35	M	TLV	6
IMSI	IMSI/11.3.14	M	TLV	5-10
Target Cell Identifier (note 1)	Cell Identifier/11.3.9	O	TLV	10
Request for Inter RAT Handover Info (note 2)	Request for Inter RAT Handover Info/11.3.106	O	TLV	3
NOTE 1: The Target Cell Identifier IE is included only for optimised Intra-BSS PS Handover.				
NOTE 2: This IE shall be included if the BSS supports inter-RAT PS handover to UTRAN.				

### 10.4.34 PS-HANDOVER-CANCEL

This PDU cancels the handover for an MS.

PDU type: PS-HANDOVER-CANCEL

Direction: BSS to SGSN

**Table 10.4.34: PS-HANDOVER-CANCEL PDU content**

Information elements	Type / Reference	Presence	Format	Length
----------------------	------------------	----------	--------	--------

PDU type	PDU type/11.3.26	M	V	1
TLLI	TLLI/11.3.35	M	TLV	6
Cause	Cause/11.3.8	M	TLV	3
Source Cell Identifier	Cell Identifier/11.3.9	M	TLV	10
Target Cell Identifier (note 1)	Cell Identifier/11.3.9	C	TLV	10
Target RNC Identifier (note 1) (note 2)	RNC Identifier/11.3.87	C	TLV	10
Target eNB Identifier (note 1) (note 2)	eNB Identifier/11.3.103	C	TLV	3-n
NOTE 1: One and only one of these three conditional IEs shall be present depending on the target RAT as specified in subclause 8a.7.				
NOTE 2: In case of PS handover to E-UTRAN, the Target RNC Identifier IE (carrying the Corresponding RNC-ID) may be present as an alternative to the Target eNB identifier IE.				

### 10.4.35 PS-HANDOVER-COMPLETE-ACK

This PDU provides to the BSS the *Inter RAT Handover Info* IE. It is sent only if requested by the BSS.

PDU type: PS-HANDOVER-COMPLETE-ACK

Direction: SGSN to BSS

**Table 10.4.35: PS-HANDOVER-COMPLETE-ACK PDU content**

Information elements	Type / Reference	Presence	Format	Length
PDU type	PDU type/11.3.26	M	V	1
TLLI	TLLI/11.3.35	M	TLV	6
Inter RAT Handover Info	Inter RAT Handover Info/11.3.94	M (note 1)	TLV	3-?
E-UTRAN Inter RAT Handover Info	E-UTRAN Inter RAT Handover Info/11.3.104	O (note 1)	TLV	3-?
NOTE 1: Only Inter RAT Handover Info IE shall be present in the message. <i>E-UTRAN Inter RAT Handover Info</i> IE was defined in an earlier version of the protocol and shall not be used.				

### 10.4.36 OVERLOAD

This PDU informs the BSS that the SGSN sending the PDU is in an overload situation and the signalling traffic to the SGSN should be reduced.

PDU type: OVERLOAD

Direction: SGSN to BSS

**Table 10.4.36: OVERLOAD PDU content**

Information elements	Type / Reference	Presence	Format	Length
PDU type	PDU type/11.3.26	M	V	1
Priority Class Indicator	Priority Class Indicator/11.3.118	M	TLV	3

## 10.5 PDU functional definitions and contents at LCS SAP

### 10.5.1 PERFORM-LOCATION-REQUEST

This PDU allows the SGSN to request the BSS to perform a location procedure for the target MS.

PDU type:       PERFORM-LOCATION-REQUEST

Direction:       SGSN to BSS

**Table 10.5.1: PERFORM-LOCATION-REQUEST PDU content**

Information elements	Type / Reference	Presence	Format	Length
PDU type	PDU type/11.3.26	M	V	1
TLLI	TLLI/11.3.35	M	TLV	6
IMSI	IMSI/11.3.14	M	TLV	5-10
DRX Parameters (note 1)	DRX Parameters/11.3.11	O	TLV	4
BVCI (PCU-PTP)	BVCI/11.3.6	M	TLV	4
NSEI (PCU-PTP)	NSEI/11.3.48	M	TLV	4-?
Location Type	Location Type/11.3.53	M	TLV	3-?
Cell Identifier	Cell Identifier/11.3.9	M	TLV	10
LCS Capability (note 2)	LCS Capability/11.3.59	O	TLV	3-?
LCS Priority	LCS Priority/11.3.57	O	TLV	3-?
LCS QoS	LCS QoS/11.3.50	O	TLV	3-?
LCS Client Type (note 3)	LCS Client Type/11.3.51	C	TLV	3-?
Requested GPS Assistance Data (note 4)	Requested GPS Assistance Data/11.3.52	O	TLV	3-?
IMEI (note 5)	IMEI/11.3.91	O	TLV	10
GANSS Location Type	GANSS Location Type / 11.3.100	C	TLV	3
Requested GANSS Assistance Data (note 6)	Requested GANSS Assistance Data/11.3.99	O	TLV	3-?
eDRX Parameters (note 7)	eDRX Parameters/11.3.122	O	TLV	3
Coverage Class	Coverage Class/11.3.124	O	TLV	3
MS Radio Access Capability (note 8)	MS Radio Access Capability/11.3.22	O	TLV	7-?
<p>NOTE 1: This IE is present if the SGSN has valid DRX Parameters for the TLLI.</p> <p>NOTE 2: This IE is present if the SGSN has received the information from the MS.</p> <p>NOTE 3: This IE is present if the location type indicates a request for a location estimate and is optional otherwise.</p> <p>NOTE 4: This IE is present if GPS assistance data is requested.</p> <p>NOTE 5: The IMEI could be sent in addition to the IMSI for the purpose of allowing correlation between the two identities.</p> <p>NOTE 6: This IE is present if GANSS assistance data is requested.</p> <p>NOTE 7: If the SGSN has valid eDRX Parameters for a TLLI it shall include the eDRX Parameters IE in which case the DRX Parameters IE shall not be included. For the case where PSM is enabled with eDRX and the Active timer is running the SGSN shall always include the negotiated eDRX value in the eDRX Parameters IE.</p> <p>NOTE 8: The field shall be present if there is valid MS Radio Access Capability information for the MS known by the SGSN; the field shall not be present otherwise.</p>				



## 10.5.2 PERFORM-LOCATION-RESPONSE

This PDU allows the BSS to respond to the SGSN after the completion of the location procedure.

PDU type: PERFORM-LOCATION-RESPONSE

Direction: BSS to SGSN

**Table 10.5.2: PERFORM-LOCATION-RESPONSE PDU content**

Information elements	Type / Reference	Presence	Format	Length
PDU type	PDU type/11.3.26	M	V	1
TLLI	TLLI/11.3.35	M	TLV	6
BVCI (PCU-PTP)	BVCI/11.3.6	M	TLV	4
Location Estimate (note 1)	Location Estimate/11.3.54	C	TLV	3-?
Positioning Data	Positioning Data/11.3.55	O	TLV	3-?
Deciphering Keys (note 2)	Deciphering Keys/11.3.56	C	TLV	3-?
LCS Cause (note 3)	LCS Cause/11.3.58	O	TLV	3-?
Velocity Data	Velocity Data/11.3.96	O	TLV	3-?
GANSS Positioning Data	GANSS Positioning Data / 11.3.101	O	TLV	3-?
NOTE 1: This IE is present if the location of the target MS was requested and the procedure succeeded.				
NOTE 2: This IE is present if the deciphering keys were requested and the procedure succeeded.				
NOTE 3: This IE is present if the procedure failed.				

## 10.5.3 PERFORM-LOCATION-ABORT

This PDU allows the SGSN to request the BSS to ABORT the LCS procedure.

PDU type: PERFORM-LOCATION-ABORT

Direction: SGSN to BSS

**Table 10.5.3: PERFORM-LOCATION-ABORT PDU content**

Information elements	Type / Reference	Presence	Format	Length
PDU type	PDU type/11.3.26	M	V	1
TLLI	TLLI/11.3.35	M	TLV	6
BVCI (PCU-PTP)	BVCI/11.3.6	M	TLV	4
LCS Cause	LCS Cause/11.3.58	M	TLV	3-?

## 10.5.4 POSITION-COMMAND

This PDU allows the BSS to request the SGSN to perform the position command procedure.

PDU type: POSITION-COMMAND

Direction: BSS to SGSN

**Table 10.5.4: POSITION-COMMAND PDU content**

Information elements	Type / Reference	Presence	Format	Length
PDU type	PDU type/11.3.26	M	V	1
TLLI	TLLI/11.3.35	M	TLV	6
BVCI (PCU-PTP)	BVCI/11.3.6	M	TLV	4
RRLP Flags	RRLP Flags/11.3.60	M	TLV	3
RRLP APDU	RRLP APDU/11.3.49	M	TLV	3-?

## 10.5.5 POSITION-RESPONSE

This PDU allows the SGSN to respond to the position command request procedure.

PDU type: POSITION-RESPONSE

Direction: SGSN to BSS

**Table 10.5.5: POSITION-RESPONSE PDU content**

Information elements	Type / Reference	Presence	Format	Length
PDU type	PDU type/11.3.26	M	V	1
TLLI	TLLI/11.3.35	M	TLV	6
BVCI (PCU-PTP)	BVCI/11.3.6	M	TLV	4
RRLP Flags a)	RRLP Flags/11.3.60	C	TLV	3
RRLP APDU a)	RRLP APDU/11.3.49	C	TLV	3-?
LCS Cause b)	LCS Cause/11.3.58	O	TLV	3-?
a)	This IE is present if the procedure succeeded.			
b)	This IE is present if the procedure failed.			

## 10.6 PDU functional definitions and contents at RIM SAP

### 10.6.1 RAN-INFORMATION-REQUEST

The RAN-INFORMATION-REQUEST PDU allows a controlling BSS to request information from another BSS.

PDU type: RAN-INFORMATION-REQUEST

Direction: BSS to SGSN  
SGSN to BSS

**Table 10.6.1: RAN-INFORMATION-REQUEST PDU content**

Information elements	Type / Reference	Presence	Format	Length
PDU type	PDU type/11.3.26	M	V	1
Destination Cell Identifier	RIM Routing Information/11.3.70	M	TLV	3-?
Source Cell Identifier	RIM Routing Information/11.3.70	M	TLV	3-?
RIM Container	RAN-INFORMATION-REQUEST RIM Container/11.3.62a.1	M	TLV	3-?

## 10.6.2 RAN-INFORMATION

The RAN-INFORMATION PDU allows a serving BSS to send information to a controlling BSS.

PDU type: RAN-INFORMATION

Direction: BSS to SGSN  
SGSN to BSS

**Table 10.6.2: RAN-INFORMATION-PDU content**

Information elements	Type / Reference	Presence	Format	Length
PDU type	PDU type/11.3.26	M	V	1
Destination Cell Identifier	RIM Routing Information/11.3.70	M	TLV	3-?
Source Cell Identifier	RIM Routing Information/11.3.70	M	TLV	3-?
RIM Container	RAN-INFORMATION RIM Container/11.3.62a.2	M	TLV	3-?

## 10.6.3 RAN-INFORMATION-ACK

The RAN-INFORMATION-ACK PDU allows a controlling BSS to acknowledge the reception of a RAN-INFORMATION PDU and a serving BSS to acknowledge the reception of a RAN-INFORMATION-APPLICATION-ERROR PDU.

PDU type: RAN-INFORMATION-ACK

Direction: BSS to SGSN  
SGSN to BSS

**Table 10.6.3: RAN-INFORMATION-ACK PDU content**

Information elements	Type / Reference	Presence	Format	Length
PDU type	PDU type/11.3.26	M	V	1
Destination Cell Identifier	RIM Routing Information/11.3.70	M	TLV	3-?
Source Cell Identifier	RIM Routing Information/11.3.70	M	TLV	3-?
RIM Container	RAN-INFORMATION-ACK RIM Container/11.3.62a.3	M	TLV	3-?

## 10.6.4 RAN-INFORMATION-ERROR

The RAN-INFORMATION-ERROR PDU allows a BSS to send an error PDU back to an originating BSS as a response to a RAN-INFORMATION, a RAN-INFORMATION-REQUEST, a RAN-INFORMATION-ACK or a RAN-INFORMATION-APPLICATION-ERROR PDU.

PDU type: RAN-INFORMATION-ERROR

Direction: BSS to SGSN  
SGSN to BSS

**Table 10.6.4: RAN-INFORMATION-ERROR content**

Information elements	Type / Reference	Presence	Format	Length
PDU type	PDU type/11.3.26	M	V	1
Destination Cell Identifier	RIM Routing Information/11.3.70	M	TLV	3-?
Source Cell Identifier	RIM Routing Information/11.3.70	M	TLV	3-?
RIM Container	RAN-INFORMATION-ERROR RIM Container/11.3.62a.4	M	TLV	3-?

## 10.6.5 RAN-INFORMATION-APPLICATION-ERROR

The RAN-INFORMATION-APPLICATION-ERROR PDU allows a controlling BSS to inform the serving BSS about erroneous application information in a previously received RAN-INFORMATION PDU.

PDU type: RAN-INFORMATION-APPLICATION-ERROR

Direction: BSS to SGSN  
SGSN to BSS

**Table 10.6.5: RAN-INFORMATION-APPLICATION-ERROR PDU content**

Information elements	Type / Reference	Presence	Format	Length
PDU type	PDU type/11.3.26	M	V	1
Destination Cell Identifier	RIM Routing Information/11.3.70	M	TLV	3-?
Source Cell Identifier	RIM Routing Information/11.3.70	M	TLV	3-?
RIM Container	RAN-INFORMATION-APPLICATION-ERROR RIM Container/11.3.62a.5	M	TLV	3-?

## 10.7 PDU functional definitions and contents at MBMS SAP

### 10.7.1 MBMS-SESSION-START-REQUEST

This PDU allows a SGSN to request BSS to start an MBMS session.

PDU type: MBMS-SESSION-START-REQUEST

Direction: SGSN to BSS

**Table 10.7.1: MBMS-SESSION-START-REQUEST PDU content**

Information elements	Type / Reference	Presence	Format	Length
PDU type	PDU type/11.3.26	M	V	1
TMGI	TMGI/11.3.77	M	TLV	3-8
MBMS Session Identity	MBMS Session Identity/11.3.71	O	TLV	3
ABQP	ABQP/11.3.43	M	TLV	13-?
MBMS Service Area Identity List	MBMS Service Area Identity List/11.3.73	M	TLV	4-?
MBMS Routing Area List	MBMS Routing Area List/11.3.75	M	TLV	3-?
MBMS Session Duration	MBMS Session Duration/11.3.72	M	TLV	3-?
MBMS Session Information	MBMS Session Information/11.3.76	M	TLV	3
Time to MBMS Data Transfer	Time to MBMS Data Transfer/11.3.92	M	TLV	3
Allocation/Retention Priority	Priority/11.3.27	O	TLV	3
MBMS Session Repetition Number	MBMS Session Repetition Number/11.3.93	O	TLV	3

## 10.7.2 MBMS-SESSION-START-RESPONSE

This PDU allows a BSS to acknowledge to SGSN that it will start an MBMS session or to indicate to SGSN why the MBMS Service Context cannot be created or is released by the BSS.

PDU type: MBMS-SESSION-START-RESPONSE

Direction: BSS to SGSN

**Table 10.7.2: MBMS-SESSION-START-RESPONSE PDU content**

Information elements	Type / Reference	Presence	Format	Length
PDU type	PDU type/11.3.26	M	V	1
TMGI	TMGI/ 11.3.77	M	TLV	3-8
MBMS Session Identity	MBMS Session Identity/ 11.3.71	O	TLV	3
MBMS Response	MBMS Response/ 11.3.74	M	TLV	3

## 10.7.3 MBMS-SESSION-STOP-REQUEST

This PDU allows a SGSN to request BSS to stop an MBMS session.

PDU type: MBMS-SESSION-STOP-REQUEST

Direction: SGSN to BSS

**Table 10.7.3: MBMS-SESSION-STOP-REQUEST PDU content**

Information elements	Type / Reference	Presence	Format	Length
PDU type	PDU type/11.3.26	M	V	1
TMGI	TMGI/ 11.3.77	M	TLV	3-8
MBMS Session Identity	MBMS Session Identity/ 11.3.71	O	TLV	3
MBMS Stop Cause	MBMS Stop Cause/11.3.78	M	TLV	3

## 10.7.4 MBMS-SESSION-STOP-RESPONSE

This PDU allows a BSS to acknowledge to SGSN that it will stop an MBMS session.

PDU type: MBMS-SESSION-STOP-RESPONSE

Direction: BSS to SGSN

**Table 10.7.4: MBMS-SESSION-STOP-RESPONSE PDU content**

Information elements	Type / Reference	Presence	Format	Length
PDU type	PDU type/11.3.26	M	V	1
TMGI	TMGI/ 11.3.77	M	TLV	3-8
MBMS Session Identity	MBMS Session Identity/ 11.3.71	O	TLV	3
MBMS Response	MBMS Response/ 11.3.74	M	TLV	3

## 10.7.5 MBMS-SESSION-UPDATE-REQUEST

This PDU allows an SGSN to request BSS to update the MBMS service area list of an ongoing MBMS broadcast service session.

PDU type: MBMS-SESSION-UPDATE-REQUEST

Direction: SGSN to BSS

**Table 10.7.5: MBMS-SESSION-UPDATE-REQUEST PDU content**

Information elements	Type / Reference	Presence	Format	Length
PDU type	PDU type/11.3.26	M	V	1
TMGI	TMGI/11.3.77	M	TLV	3-8
MBMS Session Identity	MBMS Session Identity/11.3.71	O	TLV	3
ABQP	ABQP/11.3.43	M	TLV	13-?
MBMS Service Area Identity List	MBMS Service Area Identity List/11.3.73	M	TLV	4-?
MBMS Routing Area List	MBMS Routing Area List/11.3.75	M	TLV	3-?
MBMS Session Duration	MBMS Session Duration/11.3.72	M	TLV	3-?
MBMS Session Information	MBMS Session Information/11.3.76	M	TLV	3
Time to MBMS Data Transfer	Time to MBMS Data Transfer/11.3.92	M	TLV	3
Allocation/Retention Priority	Priority/11.3.27	O	TLV	3
MBMS Session Repetition Number	MBMS Session Repetition Number/11.3.93	O	TLV	3

## 10.7.6 MBMS-SESSION-UPDATE-RESPONSE

This PDU allows a BSS to acknowledge to SGSN that it will update the MBMS service area list of an ongoing MBMS broadcast service session or to indicate to SGSN why the MBMS Service Context cannot be created or is released by the BSS.

PDU type: MBMS-SESSION-UPDATE-RESPONSE

Direction: BSS to SGSN

**Table 10.7.6: MBMS-SESSION-UPDATE-RESPONSE PDU content**

Information elements	Type / Reference	Presence	Format	Length
PDU type	PDU type/11.3.26	M	V	1
TMGI	TMGI/ 11.3.77	M	TLV	3-8
MBMS Session Identity	MBMS Session Identity/ 11.3.71	O	TLV	3
MBMS Response	MBMS Response/ 11.3.74	M	TLV	3

---

# 11 General information elements coding

The figures and text in this sub-clause describe the Information Elements contents.

## 11.1 General structure of the information elements

Refer to General Structure Of The Information Elements/3GPP TS 48.016.

## 11.2 Information element description

Refer to Information Element Description/3GPP TS 48.016.

## 11.3 Information Element Identifier (IEI)

An Information Element Identifier (IEI) is identified by the same coding in all BSSGP PDUs.

**Table 11.3: IEI types**

IEI coding (hexadecimal)	IEI Types
x00	Alignment Octets
x01	Bmax default MS
x02	BSS Area Indication
x03	Bucket Leak Rate
x04	BVCI
x05	BVC Bucket Size
x06	BVC Measurement
x07	Cause
x08	Cell Identifier
x09	Channel needed
x0a	DRX Parameters
x0b	eMLPP-Priority
x0c	Flush Action
x0d	IMSI
x0e	LLC-PDU
x0f	LLC Frames Discarded
x10	Location Area
x11	Mobile Id
x12	MS Bucket Size
x13	MS Radio Access Capability
x14	OMC Id
x15	PDU In Error
x16	PDU Lifetime
x17	Priority
x18	QoS Profile
x19	Radio Cause
x1a	RA-Cap-UPD-Cause
x1b	Routeing Area
x1c	R_default_MS
x1d	Suspend Reference Number
x1e	Tag
x1f	TLLI
x20	TMSI
x21	Trace Reference
x22	Trace Type
x23	TransactionId
x24	Trigger Id
x25	Number of octets affected
x26	LSA Identifier List
x27	LSA Information
x28	Packet Flow Identifier
x29	GPRS Timer
x3a	Aggregate BSS QoS Profile (ABQP)
x3b	Feature Bitmap
x3c	Bucket_Full Ratio
x3d	Service UTRAN CCO (Cell Change Order)
x3e	NSEI
x3f	RRLP APDU
x40	LCS QoS
x41	LCS Client Type
x42	Requested GPS Assistance Data
x43	Location Type
x44	Location Estimate
x45	Positioning Data
x46	Deciphering Keys

IEI coding (hexadecimal)	IEI Types
x47	LCS Priority
x48	LCS Cause
x49	LCS Capability
x4a	RRLP Flags
x4b	RIM Application Identity
x4c	RIM Sequence number
x4d	RAN-INFORMATION-REQUEST Application Container
x4e	RAN-INFORMATION Application Container
x4f	RIM PDU Indications
x50	This value is reserved for future use and shall be treated by the recipient as an unknown IEI
x51	This value should not be used, as it has been used in earlier versions of this protocol.
x52	PFC flow control parameters
x53	Global CN-Id
x54	RIM Routing Information
x55	RIM Protocol Version Number
x56	Application Error Container
x57	RAN-INFORMATION-REQUEST RIM Container
x58	RAN-INFORMATION RIM Container
x59	RAN-INFORMATION-APPLICATION-ERROR RIM Container
x5a	RAN-INFORMATION-ACK RIM Container
x5b	RAN-INFORMATION-ERROR RIM Container
x5c	TMGI
x5d	MBMS Session Identity
x5e	MBMS Session Duration
x5f	MBMS Service Area Identity List
x60	MBMS Response
x61	MBMS Routing Area List
x62	MBMS Session Information
x63	MBMS Stop Cause
x64	Source BSS to Target BSS Transparent Container
x65	Target BSS to Source BSS Transparent Container
x66	NAS container for PS Handover
x67	PFCs to be set-up list
x68	List of set-up PFCs
x69	Extended Feature Bitmap
x6a	Source to Target Transparent Container
x6b	Target to Source Transparent Container
x6c	RNC Identifier
x6d	Page Mode
x6e	Container ID
x6f	Global TFI
x70	IMEI
x71	Time to MBMS Data Transfer
x72	MBMS Session Repetition Number
x73	Inter RAT Handover Info
x74	PS Handover Command
x75	PS Handover Indications
x76	SI/PSI Container
x77	Active PFCs List
x78	Velocity Data
x79	DTM Handover Command
x7a	CS Indication
x7b	Requested GANSS Assistance Data
x7c	GANSS Location Type
x7d	GANSS Positioning Data
x7e	Flow Control Granularity
x7f	eNB Identifier
x80	E-UTRAN Inter RAT Handover Info
x81	Subscriber Profile ID for RAT/Frequency priority
x82	Request for Inter RAT Handover Info



IEI coding (hexadecimal)	IEI Types
x83	Reliable Inter RAT Handover Info
x84	SON Transfer Application Identity
x85	CSG Identifier
x86	TAC
x87	Redirect Attempt Flag
x88	Redirection Indication
x89	Redirection Completed
x8a	Unconfirmed send state variable
x8b	IRAT Measurement Configuration
x8c	SCI
X8d	GGSN/P-GW location
x8e	Selected PLMN ID
x8f	Priority Class Indicator
x90	Source Cell ID
x91	IRAT Measurement Configuration (extended E-ARFCNs)
x92	eDRX Parameters
x93	Time Until Next Paging Occasion
x98	Coverage Class
X99	Paging Attempt Information
X9a	Exception Report Flag
x9b	Old Routing Area Identification
x9c	Attach Indicator
x9d	PLMN Identity
x9e	MME Query

### 11.3.1 Alignment octets

The Alignment Octets are used to align a subsequent IEI onto a 32 bit boundary. The element coding is:

**Table 11.3.1: Alignment octets IE**

	8	7	6	5	4	3	2	1
octet 1	IEI							
octet 2, 2a	Length Indicator (note)							
octet 3-5	spare octet							
NOTE:	The Length Indicator may indicate that from 0 to 3 spare octets are present.							

### 11.3.2 Bmax default MS

This information element indicates the default bucket size (Bmax) in octets for an MS. The element coding is:

**Table 11.3.2: Bmax default MS IE**

	8	7	6	5	4	3	2	1
octet 1	IEI							
octet 2, 2a	Length Indicator							
octet 3-4	Bmax							

The Bmax field is coded as Bmax of BVC Bucket Size, see sub-clause 11.3.5.

### 11.3.3 BSS Area Indication

This element is used to indicate that the paging shall be done in all the cells within the BSS. The element coding is:

**Table 11.3.3: BSS Area Indication IE**

	8	7	6	5	4	3	2	1
octet 1	IEI							
octet 2, 2a	Length Indicator							
octet 3	BSS indicator							

The coding of octet 2 is a binary number indicating the Length of the remaining element.

The coding of octet 3 shall not be specified. The recipient shall ignore the value of this octet.

### 11.3.4 Bucket Leak Rate (R)

This information element indicates the leak rate (R) to be applied to a flow control bucket. The element coding is:

**Table 11.3.4: Bucket Leak Rate IE**

	8	7	6	5	4	3	2	1
octet 1	IEI							
octet 2, 2a	Length Indicator							
octet 3	R Value (MSB)							
octet 4	R Value (LSB)							

If the Gigabit Interface feature has not been negotiated, the R field is the binary encoding of the rate information expressed in 100 bits/s increments, starting from 0 x 100 bits/s until 65 535 x 100 bits/s (6 Mbps).

If the Gigabit Interface feature has been negotiated, the R field is the binary encoding of the rate information expressed in increments as defined by the *Flow Control Granularity* IE.

### 11.3.5 BVC Bucket Size

This information element indicates the maximum bucket size (Bmax) in octets for a BVC. The element coding is:

**Table 11.3.5: BVC Bucket Size IE**

	8	7	6	5	4	3	2	1
octet 1	IEI							
octet 2, 2a	Length Indicator							
octet 3	Bmax (MSB)							
octet 4	Bmax (LSB)							

If the Gigabit Interface feature has not been negotiated, the Bmax field is the binary encoding of the bucket-size information expressed in 100 octet increments, starting from 0 x 100 octets until 65 535 x 100 octets (6 Mbytes).

If the Gigabit Interface feature has been negotiated, the Bmax field is the binary encoding of the rate information expressed in increments as defined by the *Flow Control Granularity* IE.

### 11.3.6 BVCI (BSSGP Virtual Connection Identifier)

The BVCI identifies a BVC. The element coding is:

**Table 11.3.6: BVCI IE**

	8	7	6	5	4	3	2	1
octet 1	IEI							
octet 2, 2a	Length Indicator							
octet 3-4	Unstructured value							

## 11.3.7 BVC Measurement

This information element describes average queuing delay for a BVC. The element coding is:

**Table 11.3.7: BVC Measurement IE**

	8	7	6	5	4	3	2	1
octet 1	IEI							
octet 2, 2a	Length Indicator							
octet 3,4	Delay Value (in centi-seconds)							

The Delay Value field is coded as a 16-bit integer value in units of centi-seconds (one hundredth of a second). This coding provides a range of over 10 minutes in increments of 10 ms. As a special case, the hexadecimal value 0xFFFF (decimal 65 535) shall be interpreted as "infinite delay".

## 11.3.8 Cause

The Cause information element indicates the reason for an exception condition. The element coding is:

**Table 11.3.8.a: Cause IE**

	8	7	6	5	4	3	2	1
octet 1	IEI							
octet 2, 2a	Length Indicator							
octet 3	Cause value							

Table 11.3.8.b: Cause coding

Cause value Hexadecimal	Semantics of coding
	All values not listed below shall be treated as "protocol error - unspecified"
x00	Processor overload
x01	Equipment failure
x02	Transit network service failure
x03	Network service transmission capacity modified from zero kbps to greater than zero kbps
x04	Unknown MS
x05	BVCI unknown
x06	cell traffic congestion
x07	SGSN congestion
x08	O&M intervention
x09	BVCI-blocked
x0a	PFC create failure
x0b	PFC preempted
x0c	ABQP no more supported
x20	Semantically incorrect PDU
x21	Invalid mandatory information
x22	Missing mandatory IE
x23	Missing conditional IE
x24	Unexpected conditional IE
x25	Conditional IE error
x26	PDU not compatible with the protocol state
x27	Protocol error - unspecified
x28	PDU not compatible with the feature set
x29	Requested Information not available
x2a	Unknown Destination address
x2b	Unknown RIM Application Identity or RIM application disabled
x2c	Invalid Container Unit Information
x2d	PFC queuing
x2e	PFC created successfully
x2f	T12 expiry
x30	MS under PS Handover treatment
x31	Uplink quality
x32	Uplink strength
x33	Downlink quality
x34	Downlink strength
x35	Distance
x36	Better cell
x37	Traffic
x38	Radio contact lost with MS
x39	MS back on old channel
x3a	T13 expiry
x3b	T14 expiry
x3c	Not all requested PFCs created
x3d	CS cause
x3e	Requested ciphering and/or integrity protection algorithms not supported
x3f	Relocation failure in target system
x40	Directed Retry
x41	Time critical relocation
x42	PS Handover Target not allowed
x43	PS Handover not Supported in Target BSS or Target System
x44	Incoming relocation not supported due to PUESBINE feature
x45	DTM Handover - No CS resource
x46	DTM Handover - PS Allocation failure
x47	DTM Handover - T24 expiry

x48	DTM Handover - Invalid CS Indication IE
x49	DTM Handover - T23 expiry
x4a	DTM Handover - MSC Error
x4b	Invalid CSG cell
x80 to x87	Reserved for further definition of non-critical PS handover cause values

NOTE: If received, cause values x80 to x87 inclusive indicate a non-critical PS Handover (see sub-clause 8a.5).

### 11.3.9 Cell Identifier

This information element uniquely identifies one cell. The element coding is:

**Table 11.3.9: Cell Identifier IE**

	8	7	6	5	4	3	2	1
octet 1	IEI							
octet 2, 2a	Length Indicator							
octets 3-8	Octets 3 to 8 contain the value part (starting with octet 2) of the <i>Routing Area Identification IE</i> defined in 3GPP TS 24.008, not including 3GPP TS 24.008 IEI							
octets 9-10	Octets 9 and 10 contain the value part (starting with octet 2) of the <i>Cell Identity IE</i> defined in 3GPP TS 24.008, not including 3GPP TS 24.008 IEI							

### 11.3.10 Channel needed

This information element is coded as defined in 3GPP TS 29.018. It is relevant to circuit-switched paging requests. The element coding is:

**Table 11.3.10: Channel needed IE**

	8	7	6	5	4	3	2	1
octet 1	IEI							
octet 2, 2a	Length Indicator							
octet 3	Rest of element coded as the value part of the Channel Needed PDU defined in 3GPP TS 29.018, not including 3GPP TS 29.018 IEI and 3GPP TS 29.018 length indicator							

### 11.3.11 DRX Parameters

This information element contains MS specific DRX information. The element coding is:

**Table 11.3.11: DRX Parameters IE**

	8	7	6	5	4	3	2	1
octet 1	IEI							
octet 2, 2a	Length Indicator							
octet 3-n	Rest of element coded as the value part defined in 3GPP TS 24.008, not including 3GPP TS 24.008 IEI and 3GPP TS 24.008 octet length indicator							

### 11.3.12 eMLPP-Priority

This element indicates the eMLPP-Priority of a PDU. The element coding is:

**Table 11.3.12: eMLPP-Priority IE**

	8	7	6	5	4	3	2	1
octet 1	IEI							
octet 2, 2a	Length Indicator							
octet 3	Rest of element coded as the value part of the eMLPP-Priority IE defined in 3GPP TS 48.008, not including 3GPP TS 48.008 IEI and 3GPP TS 48.008 length indicator							

### 11.3.13 Flush Action

The Flush action information element indicates to the SGSN the action taken by the BSS in response to the flush request. The element coding is:

**Table 11.3.13.a: Flush Action IE**

	8	7	6	5	4	3	2	1
octet 1	IEI							
octet 2, 2a	Length Indicator							
octet 3	Action value							

**Table 11.3.13.b: Action coding**

Action value Hexadecimal	Semantics of coding
x00	LLC-PDU(s) deleted
x01	LLC-PDU(s) transferred
	All values not explicitly shown are reserved for future use

### 11.3.14 IMSI

This information element contains the International Mobile Subscriber Identity (see 3GPP TS 23.003). The element coding is:

**Table 11.3.14: IMSI IE**

	8	7	6	5	4	3	2	1
octet 1	IEI							
octet 2, 2a	Length Indicator							
octet 3-n	Octets 3-n contain an IMSI coded as the value part of the <i>Mobile Identity</i> IE defined in 3GPP TS 24.008 (NOTE 1)							
NOTE 1: The <i>Type of identity</i> field in the <i>Mobile Identity</i> IE shall be ignored by the receiver.								

### 11.3.15 LLC-PDU

This information element contains an LLC-PDU. The element coding is:

**Table 11.3.15: LLC-PDU IE**

	8	7	6	5	4	3	2	1
octet 1	IEI							
octet 2, 2a	Length Indicator							
octet 3	LLC-PDU (first part)							
octet n	LLC-PDU (last part)							

### 11.3.16 LLC Frames Discarded

This element describes the number of LLC frames that have been discarded inside a BSS. The element coding is:

**Table 11.3.16: LLC Frames Discarded IE**

	8	7	6	5	4	3	2	1
octet 1	IEI							
octet 2, 2a	Length Indicator							
octet 3	Number of frames discarded (in hexadecimal)							

### 11.3.17 Location Area

This element uniquely identifies one Location Area. The element coding is:

**Table 11.3.17: Location Area IE**

	8	7	6	5	4	3	2	1
octet 1	IEI							
octet 2, 2a	Length Indicator							
octets 3-7	Octets 3 to 7 contain the value part (starting with octet 2) of the <i>Location Area Identification IE</i> defined in 3GPP TS 24.008, not including 3GPP TS 24.008 IEI							

The coding of octet 2 is a binary number indicating the Length of the remaining element.

### 11.3.18 LSA Identifier List

This information element uniquely identifies LSAs. The element coding is:

**Table 11.3.18: LSA Identifier List IE**

	8	7	6	5	4	3	2	1
octet 1	IEI							
octet 2, 2a	Length Indicator							
octet 3-?	Rest of element coded as in 3GPP TS 48.008, not including 3GPP TS 48.008 IEI and 3GPP TS 48.008 length indicator							

### 11.3.19 LSA Information

This information element uniquely identifies LSAs, the priority of each LSA and the access right outside these LSAs. The element coding is:

**Table 11.3.19: LSA Information IE**

	8	7	6	5	4	3	2	1
octet 1	IEI							
octet 2, 2a	Length Indicator							
octet 3-?	Rest of element coded as in 3GPP TS 48.008, not including 3GPP TS 48.008 IEI and 3GPP TS 48.008 length indicator							

### 11.3.20 Mobile Id

The element coding is:

**Table 11.3.20: Mobile Id IE**

	8	7	6	5	4	3	2	1
octet 1	IEI							
octet 2, 2a	Length Indicator							
octet 3-n	Octets 3-n contain either the IMSI, IMEISV or IMEI coded as the value part (starting with octet 3) of the <i>Mobile Identity IE</i> defined in 3GPP TS 24.008, not including 3GPP TS 24.008 IEI and 3GPP TS 24.008 length indicator							

### 11.3.21 MS Bucket Size

This information element indicates an MS's bucket size (Bmax). The element coding is:

**Table 11.3.21: MS Bucket Size IE**

	8	7	6	5	4	3	2	1
octet 1	IEI							
octet 2, 2a	Length Indicator							
octet 3-4	Bmax							

The Bmax field is coded as Bmax of BVC Bucket Size, see sub-clause 11.3.5.

### 11.3.22 MS Radio Access Capability

This information element contains the capabilities of the ME. The element coding is:

**Table 11.3.22: MS Radio Access Capability IE**

	8	7	6	5	4	3	2	1
octet 1	IEI							
octet 2, 2a	Length Indicator							
octet 3-?	Rest of element coded as the value part defined in 3GPP TS 24.008, not including 3GPP TS 24.008 IEI and 3GPP TS 24.008 octet length indicator.							

### 11.3.23 OMC Id

The element coding is:

**Table 11.3.23: OMC Id IE**

	8	7	6	5	4	3	2	1
octet 1	IEI							
octet 2, 2a	Length Indicator							
octet 3-22	For the OMC identity, see 3GPP TS 12.20							

### 11.3.24 PDU In Error

The element coding is:

**Table 11.3.24: PDU In Error IE**

	8	7	6	5	4	3	2	1
octet 1	IEI							
octet 2, 2a	Length Indicator							
octet 3-?	Erroneous BSSGP PDU							



### 11.3.25 PDU Lifetime

This information element describes the PDU Lifetime for a PDU inside the BSS. The element coding is:

**Table 11.3.25: PDU Lifetime IE**

	8	7	6	5	4	3	2	1
octet 1	IEI							
octet 2, 2a	Length Indicator							
octet 3-4	Delay Value							

The Delay Value field is coded as Delay Value of BVC Measurement, see sub-clause 11.3.7.

## 11.3.26 PDU Type

The first octet of a BSSGP PDU shall contain the PDU type IE. The PDU type IE is one octet long.

**Table 11.3.26: PDU Types**

<b>PDU type coding (Hexadecimal)</b>	<b>PDU Types</b>
	<b>PDU Types</b>
	<b>PDU Types between RL and BSSGP SAPs</b>
x00	DL-UNITDATA
x01	UL-UNITDATA
x02	RA-CAPABILITY
x03	reserved (Note 1)
x04	DL-MBMS-UNITDATA
x05	UL-MBMS-UNITDATA
	<b>PDU Types between GMM SAPs</b>
x06	PAGING-PS
x07	PAGING-CS
x08	RA-CAPABILITY-UPDATE
x09	RA-CAPABILITY-UPDATE-ACK
x0a	RADIO-STATUS
x0b	SUSPEND
x0c	SUSPEND-ACK
x0d	SUSPEND-NACK
x0e	RESUME
x0f	RESUME-ACK
x10	RESUME-NACK
x11	PAGING-PS-REJECT
x12	DUMMY-PAGING-PS
x13	DUMMY-PAGING-PS-RESPONSE
x14	MS-REGISTRATION-ENQUIRY
x15	MS-REGISTRATION-ENQUIRY-RESPONSE
	<b>PDU Types between NM SAPs</b>
x20	BVC-BLOCK
x21	BVC-BLOCK-ACK
x22	BVC-RESET
x23	BVC-RESET-ACK
x24	BVC-UNBLOCK
x25	BVC-UNBLOCK-ACK
x26	FLOW-CONTROL-BVC
x27	FLOW-CONTROL-BVC-ACK
x28	FLOW-CONTROL-MS
x29	FLOW-CONTROL-MS-ACK
x2a	FLUSH-LL
x2b	FLUSH-LL-ACK
x2c	LLC-DISCARDED
x2d	FLOW-CONTROL-PFC
x2e	FLOW-CONTROL-PFC-ACK
x40	SGSN-INVOKE-TRACE
x41	STATUS
x42	OVERLOAD
	<b>PDU Types between PFM SAPs</b>
0x50	DOWNLOAD-BSS-PFC
0x51	CREATE-BSS-PFC
0x52	CREATE-BSS-PFC-ACK
0x53	CREATE-BSS-PFC-NACK
0x54	MODIFY-BSS-PFC
0x55	MODIFY-BSS-PFC-ACK
0x56	DELETE-BSS-PFC
0x57	DELETE-BSS-PFC-ACK
0x58	DELETE-BSS-PFC-REQ
0x59	PS-HANDOVER-REQUIRED
0x5a	PS-HANDOVER-REQUIRED-ACK
0x5b	PS-HANDOVER-REQUIRED-NACK

PDU type coding (Hexadecimal)	PDU Types
0x5c	PS-HANDOVER-REQUEST
0x5d	PS-HANDOVER-REQUEST-ACK
0x5e	PS-HANDOVER-REQUEST-NACK
0x91	PS-HANDOVER-COMPLETE
0x92	PS-HANDOVER-CANCEL
0x93	PS-HANDOVER-COMPLETE-ACK
	<b>PDUs between LCS SAPs</b>
0x60	PERFORM-LOCATION-REQUEST
0x61	PERFORM-LOCATION-RESPONSE
0x62	PERFORM-LOCATION-ABORT
0x63	POSITION-COMMAND
0x64	POSITION-RESPONSE
	<b>PDUs between RIM SAPs</b>
0x70	RAN-INFORMATION
0x71	RAN-INFORMATION-REQUEST
0x72	RAN-INFORMATION-ACK
0x73	RAN-INFORMATION-ERROR
0x74	RAN-INFORMATION-APPLICATION-ERROR
	<b>PDUs between MBMS SAPs</b>
0x80	MBMS-SESSION-START-REQUEST
0x81	MBMS-SESSION-START-RESPONSE
0x82	MBMS-SESSION-STOP-REQUEST
0x83	MBMS-SESSION-STOP-RESPONSE
0x84	MBMS-SESSION-UPDATE-REQUEST
0x85	MBMS-SESSION-UPDATE-RESPONSE
RESERVED	all values not explicitly shown are reserved for future use
NOTE 1: This value was allocated in an earlier version of the protocol and shall not be used.	

### 11.3.27 Priority

This element indicates the priority of a PDU. The element coding is:

**Table 11.3.27: Priority IE**

	8	7	6	5	4	3	2	1
octet 1	IEI							
octet 2, 2a	Length Indicator							
octet 3	Rest of element coded as the value part of the Priority IE defined in 3GPP TS 48.008, not including 3GPP TS 48.008 IEI and 3GPP TS 48.008 length indicator							

### 11.3.28 QoS Profile

This information element describes the QoS Profile associated with a PDU. The element coding is:

**Table 11.3.28.a: QoS Profile IE**

	8	7	6	5	4	3	2	1
octet 1	IEI							
octet 2, 2a	Length Indicator							
octet 3-4	Peak bit rate provided by the network (note)							
octet 5	Peak Bit Rate Granularity	C/R	T	A	Precedence			
NOTE: The bit rate 0 (zero) shall mean "best effort" in this IE.								

"Peak bit rate" is coded as shown below:

**Table 11.3.28.a1: Peak bit rate**

	8	7	6	5	4	3	2	1
octet 3	Peak bit rate value (MSB)							
octet 4	Peak bit rate value (LSB)							

If the Gigabit Interface feature has not been negotiated, the "Peak bit rate" field is the binary encoding of the peak bit rate information expressed in 100 bits/s increments, starting from 0 x 100 bits/s until 65 535 x 100 bits/s (6 Mbps).

If the Gigabit Interface feature has been negotiated, the "Peak bit rate" field is the binary encoding of the peak bit rate information expressed in increments as defined by the *Peak Bit Rate Granularity* field.

"Precedence" is coded as shown below (complying with 3GPP TS 23.060).

**Table 11.3.28.b: Precedence coding**

coding	semantic	
	DL-UNITDATA	UL-UNITDATA
000	High priority	Radio priority 1
001	Normal priority	Radio priority 2
010	Low priority	Radio priority 3
011	Reserved	Radio priority 4
100	Reserved	Radio Priority Unknown

All values not allocated are reserved. All reserved values shall be interpreted as value 010.

"A-bit" is coded as shown below.

**Table 11.3.28.c: "A bit" coding**

coding	semantic
0	Radio interface uses RLC/MAC ARQ functionality
1	Radio interface uses RLC/MAC-UNITDATA functionality

"T-bit" is coded as shown below.

**Table 11.3.28.d: "T bit" coding**

coding	semantic
0	The SDU contains signalling (e.g. related to GMM)
1	The SDU contains data

"C/R-bit" is coded as shown below.

**Table 11.3.28.e: "C/R bit" coding**

coding	semantic
0	The SDU contains a LLC ACK or SACK command/response frame type
1	The SDU does not contain a LLC ACK or SACK command/response frame type

"Peak Bit Rate Granularity" is coded as shown below.

**Table 11.3.28.f: "Peak Bit Rate Granularity" coding**

coding	semantic
--------	----------

00	100 bits/s increments
01	1000 bits/s increments
10	10000 bits/s increments
11	100000 bits/s increments

This field provides the granularity to be used for deriving the peak bit rate value if the Gigabit Interface feature is negotiated.

### 11.3.29 Radio Cause

This information element indicates the reason for an exception condition on the radio interface. The element coding is:

**Table 11.3.29.a: Radio Cause IE**

	<b>8</b>	<b>7</b>	<b>6</b>	<b>5</b>	<b>4</b>	<b>3</b>	<b>2</b>	<b>1</b>
octet 1	IEI							
octet 2, 2a	Length Indicator							
octet 3	Radio Cause value							

**Table 11.3.29.b: Radio Cause value**

radio cause value Hexadecimal	Semantics of coding
x00	Radio contact lost with the MS
x01	Radio link quality insufficient to continue communication
x02	cell-reselection ordered
x03	Cell reselection prepare. See Note below.
x04	Cell reselection failure. See Note below.
	All values not explicitly listed are reserved. If received, they shall be handled as "radio contact lost with the MS".
NOTE:	In case the Enhanced Radio Status feature has not been negotiated the Radio Cause values in range of x03-x04 should if received be handled as "radio contact lost with the MS". This is in order to be backwards compatible with earlier releases of the standard.

### 11.3.30 RA-Cap-UPD-Cause

The RA-Cap-UPD-Cause indicates the success of the RA-CAPABILITY-UPDATE procedure or the reason of the failure. The element coding is:

**Table 11.3.30.a: RA-Cap-UPD-Cause IE**

	<b>8</b>	<b>7</b>	<b>6</b>	<b>5</b>	<b>4</b>	<b>3</b>	<b>2</b>	<b>1</b>
octet 1	IEI							
octet 2, 2a	Length Indicator							
octet 3	RA-Cap-UPD Cause value							

**Table 11.3.30.b: RA-Cap-UPD Cause value**

RA-Cap-UPD cause value Hexadecimal	Semantics of coding

x00	OK, RA capability IE present
x01	TLLI unknown in SGSN
x02	No RA Capabilities or IMSI available for this MS
	All values not explicitly listed are reserved. If received, they shall be handled as "TLLI unknown in SGSN".

### 11.3.31 Routeing Area

This element uniquely identifies one routeing area. The element coding is:

**Table 11.3.31: Routeing Area IE**

	8	7	6	5	4	3	2	1
octet 1	IEI							
octet 2, 2a	Length Indicator							
octets 3-8	Octets 3 to 8 contain the value part (starting with octet 2) of the Routing Area Identification IE defined in 3GPP TS 24.008, not including 3GPP TS 24.008 IEI							

The coding of octet 2 is a binary number indicating the Length of the remaining element.

### 11.3.32 R\_default\_MS

This information element indicates the default bucket leak rate (R) to be applied to a flow control bucket for an MS. The element coding is:

**Table 11.3.32: R\_default\_MS IE**

	8	7	6	5	4	3	2	1
octet 1	IEI							
octet 2, 2a	Length Indicator							
octet 3-4	R_default_MS value							

The R\_default\_MS value field is coded as The "R Value" of Bucket Leak Rate, see sub-clause 11.3.4.

### 11.3.33 Suspend Reference Number

The Suspend Reference Number information element contains an un-formatted reference number for each suspend/resume transaction. The element coding is:

**Table 11.3.33: Suspend Reference Number IE**

	8	7	6	5	4	3	2	1
octet 1	IEI							
octet 2, 2a	Length Indicator							
octet 3	Suspend Reference Number							

The Suspend Reference Number is an un-formatted 8 bit field.

### 11.3.34 Tag

This information element is used to correlate request and response PDUs. The element coding is:

**Table 11.3.34: Tag IE**

	8	7	6	5	4	3	2	1

octet 1	IEI
octet 2, 2a	Length Indicator
octet 3	Unstructured value

### 11.3.35 Temporary logical link Identity (TLLI)

The element coding is:

**Table 11.3.35: TLLI IE**

	8	7	6	5	4	3	2	1
octet 1	IEI							
octet 2, 2a	Length Indicator							
octet 3-6	Rest of element coded as the value part of the TLLI information element in 3GPP TS 44.018, not including 3GPP TS 44.018 IEI.							

### 11.3.36 Temporary Mobile Subscriber Identity (TMSI)

The element coding is:

**Table 11.3.36: TMSI IE**

	8	7	6	5	4	3	2	1
octet 1	IEI							
octet 2, 2a	Length Indicator							
octet 3-6	Rest of element coded as the value part of the TMSI/P-TMSI information element in 3GPP TS 24.008, not including 3GPP TS 24.008 IEI.							

### 11.3.37 Trace Reference

This element provides a trace reference number allocated by the triggering entity. The element coding is:

**Table 11.3.37: Trace Reference IE**

	8	7	6	5	4	3	2	1
octet 1	IEI							
octet 2, 2a	Length Indicator							
octet 3-4	Trace Reference							

### 11.3.38 Trace Type

This element provides the type of trace information to be recorded. The element coding is:

**Table 11.3.38: Trace Type IE**

	8	7	6	5	4	3	2	1
octet 1	IEI							
octet 2, 2a	Length Indicator							
octet 3	This is coded as specified in Technical Specification 3GPP TS 32.008.							

### 11.3.39 Transaction Id

This element indicates a particular transaction within a trace. The element coding is:

**Table 11.3.39: Transaction Id IE**

	8	7	6	5	4	3	2	1
octet 1	IEI							
octet 2, 2a	Length Indicator							
octet 3-4	Transaction Id							

### 11.3.40 Trigger Id

This element provides the identity of the entity which initiated the trace. The element coding is:

**Table 11.3.40: Trigger Id IE**

	8	7	6	5	4	3	2	1
octet 1	IEI							
octet 2, 2a	Length Indicator							
octet 3-22	Entity Identity ( typically an OMC identity)							

### 11.3.41 Number of octets affected

This information element indicates, for an MS, the number of octets transferred or deleted by BSS. The element coding is:

**Table 11.3.41: Number of octets affected IE**

	8	7	6	5	4	3	2	1
octet 1	IEI							
octet 2, 2a	Length Indicator							
octet 3-5	number of octets transferred or deleted							

The number of octets transferred or deleted by the BSS may be higher than the maximum Bmax value (6 553 500). SGSN shall handle any value higher than 6 553 500 as the value 6 553 500.

### 11.3.42 Packet Flow Identifier (PFI)

This information element indicates the Packet Flow Identifier for a BSS Packet Flow Context. The element coding is:

**Table 11.3.42: Packet Flow Identifier (PFI) IE**

	8	7	6	5	4	3	2	1
octet 1	IEI							
octet 2, 2a	Length Indicator							
octet 3	Rest of element coded as the value part of the Packet Flow Identifier information element in 3GPP TS 24.008, not including 3GPP TS 24.008 IEI							

The BSS shall not negotiate BSS PFCs for the following pre-defined PFI values: Best Effort, Signaling, SMS, and TOM8.

PFI's have local significance to a mobile station. A BSS Packet Flow Context shall be uniquely identified by the PFI along with the IMSI or TLLI within a routing area.



### 11.3.42a (void)

### 11.3.43 Aggregate BSS QoS Profile

This information element indicates the Aggregate BSS QoS Profile (ABQP) for a BSS Packet Flow Context or an MBMS Service Context. The ABQP is considered to be a single parameter with multiple data transfer attributes as defined in 3GPP TS 23.107.

The element coding is:

**Table 11.3.43: Aggregate BSS QoS Profile IE**

	8	7	6	5	4	3	2	1
octet 1	IEI							
octet 2, 2a	Length Indicator							
octet 3-?	Rest of element coded as the value part of the QoS information element in 3GPP TS 24.008, not including 3GPP TS 24.008 IEI and length indicator. The shorter 3-byte form of QoS information is not allowed in BSSGP PDUs.							

### 11.3.44 GPRS Timer

The purpose of the *GPRS timer* information element is to specify GPRS specific timer values, e.g. the Packet Flow timer.

**Table 11.3.44: GPRS Timer IE**

	8	7	6	5	4	3	2	1
octet 1	IEI							
octet 2, 2a	Length Indicator							
octet 3	Unit Value			Timer value				

Timer value: Bits 5 to 1 represent the binary coded timer value.

Unit value: Bits 6 to 8 defines the timer value unit for the GPRS timer as follows:

Bits

**8 7 6**

0 0 0 value is incremented in multiples of 2 s

0 0 1 value is incremented in multiples of 1 minute

0 1 0 value is incremented in multiples of decihours

0 1 1 value is incremented in multiples of 500 msec

1 1 1 value indicates that the timer does not expire.

Other values shall be interpreted as multiples of 1 minute in this version of the protocol.

### 11.3.45 Feature Bitmap

The Feature bitmap information element indicates the optional features supported by the underlying NSE. The element coding is:

**Table 11.3.45.a: Feature Bitmap IE**

8	7	6	5	4	3	2	1
---	---	---	---	---	---	---	---

octet 1	IEI							
octet 2, 2a	Length Indicator							
octet 3	MBMS	Enhanced Radio Status	PFC-FC	RIM	LCS	INR	CBL	PFC

**Table 11.3.45.b: "PFC bit" coding**

coding	Semantic
0	Packet Flow Context Procedures not supported
1	Packet Flow Context Procedures supported

**Table 11.3.45.c: "CBL bit" coding**

coding	Semantic
0	Current Bucket Level Procedures not supported
1	Current Bucket Level Procedures supported

**Table 11.3.45.d: "INR bit" coding**

coding	Semantic
0	Inter-NSE re-routing not supported
1	Inter-NSE re-routing supported

**Table 11.3.45.e: "LCS bit" coding**

coding	Semantic
0	LCS Procedures not supported
1	LCS Procedures supported

**Table 11.3.45.f: "RIM bit" coding**

coding	Semantic
0	RAN Information Management (RIM) procedures not supported
1	RAN Information Management (RIM) procedures supported

**Table 11.3.45.g: "PFC-FC" coding**

coding	Semantic
0	PFC Flow Control Procedures not supported
1	PFC Flow Control Procedures supported

**Table 11.3.45.h: "Enhanced Radio Status" coding**

coding	Semantic
0	Enhanced Radio Status Procedures not supported
1	Enhanced Radio Status Procedures supported

**Table 11.3.45.i: "MBMS" coding**

coding	Semantic
0	MBMS Procedures not supported
1	MBMS Procedures supported

### 11.3.46 Bucket Full Ratio

This information element is used to convey the current bucket counter. It is binary encoded as follows:  $B_{\text{current}} \times (100 / B_{\text{max}})$ . The element coding is:

**Table 11.3.46: Bucket Full Ratio IE**

	8	7	6	5	4	3	2	1
octet 1	IEI							
octet 2, 2a	Length Indicator							
octet 3	Ratio of the bucket that is filled up with data							

The field ranges from zero (00000000) to two hundred and fifty five (11111111). A value of zero means that the bucket is empty. A value of hundred means that the bucket is exactly full, while a value of two hundred and fifty five means that the bucket is at least 2.55 times  $B_{\text{max}}$ .

### 11.3.47 Service UTRAN CCO

The Service UTRAN CCO (Cell Change Order) information element indicates whether Network initiated Cell Change Order to UTRAN or E-UTRAN or PS Handover to UTRAN or E-UTRAN should be used for the mobile station or not, and it is relevant if at least one of the procedures is used:

**Table 11.3.47.a: Service UTRAN CCO IE**

	8	7	6	5	4	3	2	1
octet 1	IEI							
octet 2, 2a	Length Indicator							
octet 3	Spare			Service E-UTRAN CCO Value part		Service UTRAN CCO Value part		

**Table 11.3.47.b: Service UTRAN CCO Value part coding**

coding bits	Semantic
321	
000	Network initiated cell change order to UTRAN or PS handover to UTRAN procedure should be performed
001	Network initiated cell change order to UTRAN or PS handover to UTRAN procedure should not be performed
010	Network initiated cell change order to UTRAN or PS handover to UTRAN procedure shall not be performed
111	If received, shall be interpreted as no information available (bits 4-5 valid)
Other values	If received, shall be interpreted as no information available

**Table 11.3.47.c: Service E-UTRAN CCO Value part coding**

coding bits	Semantic
54	
01	Network initiated cell change order to E-UTRAN or PS handover to E-UTRAN procedure should be performed
10	Network initiated cell change order to E-UTRAN or PS handover to E-UTRAN procedure should not be performed
11	Network initiated cell change order to E-UTRAN or PS handover to E-UTRAN procedure shall not be performed
00	If received, shall be interpreted as no information available

### 11.3.48 NSEI (Network Service Entity Identifier)

The NSEI unambiguously identifies a NSE. The element coding is:

**Table 11.3.48: NSEI IE**

	8	7	6	5	4	3	2	1
octet 1	IEI							
octet 2, 2a	Length Indicator							
octet 3	most significant octet of NSEI							
octet 4	least significant octet of NSEI							

### 11.3.49 RRLP APDU

This information element conveys an embedded message associated with a higher level protocol. The element coding is:

**Table 11.3.49: RRLP APDU IE**

	8	7	6	5	4	3	2	1
octet 1	IEI							
octet 2, 2a	Length Indicator							
octet 3-?	The rest of the information element contains an embedded RRLP message whose content and encoding are defined according to the 3GPP TS 44.031. The RRLP protocol is not octet aligned. Therefore, the unused bits in the last octet are padded with zeroes.							

### 11.3.50 LCS QoS

This information element provides the LCS QoS. The element coding is:

**Table 11.3.50: LCS QOS IE**

	8	7	6	5	4	3	2	1
octet 1	IEI							
octet 2, 2a	Length Indicator							
octet 3-n	Rest of element coded as the value part defined in 3GPP TS 48.008, not including 3GPP TS 48.008 IEI and 3GPP TS 48.008 octet length indicator							

### 11.3.51 LCS Client Type

This information element provides the LCS Client Type. The element coding is:

**Table 11.3.51: LCS Client Type IE**

	8	7	6	5	4	3	2	1
octet 1	IEI							
octet 2, 2a	Length Indicator							
octet 3-n	Rest of element coded as the value part defined in 3GPP TS 49.031, not including 3GPP TS 49.031 IEI and 3GPP TS 49.031 octet length indicator							

### 11.3.52 Requested GPS Assistance Data

This information element provides the information on which GPS Assistance Data has been requested. The element coding is:

**Table 11.3.52: Requested GPS Assistance Data IE**

	8	7	6	5	4	3	2	1
octet 1	IEI							
octet 2, 2a	Length Indicator							
octet 3-n	Rest of element coded as the value part defined in 3GPP TS 49.031, not including 3GPP TS 49.031 IEI and 3GPP TS 49.031 octet length indicator							

### 11.3.53 Location Type

This information element provides the Location Type. The element coding is:

**Table 11.3.53: Location Type IE**

	8	7	6	5	4	3	2	1
octet 1	IEI							
octet 2, 2a	Length Indicator							
octet 3-n	Rest of element coded as the value part defined in 3GPP TS 49.031, not including 3GPP TS 49.031 IEI and 3GPP TS 49.031 octet length indicator							

### 11.3.54 Location Estimate

This information element provides the Location Estimate. The element coding is:

**Table 11.3.54: Location Estimate IE**

	8	7	6	5	4	3	2	1
octet 1	IEI							
octet 2, 2a	Length Indicator							
octet 3-n	Rest of element coded as the value part defined in 3GPP TS 48.008, not including 3GPP TS 48.008 IEI and 3GPP TS 48.008 octet length indicator							

### 11.3.55 Positioning Data

This information element provides Positioning Data. The element coding is:

**Table 11.3.55: Positioning Data IE**

	8	7	6	5	4	3	2	1
octet 1	IEI							
octet 2, 2a	Length Indicator							
octet 3-n	Rest of element coded as the value part defined in 3GPP TS 49.031, not including 3GPP TS 49.031 IEI and 3GPP TS 49.031 octet length indicator							

### 11.3.56 Deciphering Keys

This information element provides the Deciphering Keys. The element coding is:

**Table 11.3.56: Deciphering Keys IE**

	8	7	6	5	4	3	2	1
octet 1	IEI							
octet 2, 2a	Length Indicator							
octet 3-n	Rest of element coded as the value part defined in 3GPP TS 49.031, not including 3GPP TS 49.031 IEI and 3GPP TS 49.031 octet length indicator							

### 11.3.57 LCS Priority

This information element provides the data/information on LCS Priority. The element coding is:

**Table 11.3.57: LCS Priority IE**

	8	7	6	5	4	3	2	1
octet 1	IEI							
octet 2, 2a	Length Indicator							
octet 3-n	Rest of element coded as the value part defined in 3GPP TS 49.031, not including 3GPP TS 49.031 IEI and 3GPP TS 49.031 octet length indicator							

### 11.3.58 LCS Cause

This information element provides the data/information on LCS Cause. The element coding is:

**Table 11.3.58: LCS Cause IE**

	8	7	6	5	4	3	2	1
octet 1	IEI							
octet 2, 2a	Length Indicator							
octet 3-n	Rest of element coded as the value part defined in 3GPP TS 49.031, not including 3GPP TS 49.031 IEI and 3GPP TS 49.031 octet length indicator							

### 11.3.59 LCS Capability

This information element provides the data/information on LCS Capability. The element coding is:

**Table 11.3.59: LCS Capability IE**

	8	7	6	5	4	3	2	1
octet 1	IEI							
octet 2, 2a	Length Indicator							
octet 3	Rest of element coded as the value part of the <i>PS LCS Capability</i> IE defined in 3GPP TS 24.008, not including 3GPP TS 24.008 IEI and length indicator							

### 11.3.60 RRLP Flags

This information element provides control information for the RRLP APDU. The element coding is:

**Table 11.3.60: RRLP Flags IE**

	8	7	6	5	4	3	2	1
octet 1	IEI							
octet 2, 2a	Length Indicator							
octet 3	Spare							Flag 1

The fields are coded as follows:

Flag 1 (Octet 3, bit 1):

- 0 Position Command (BSS to SGSN) or final response (SGSN to BSS);
- 1 Not a Positioning Command or final response.

Spare These bits shall be ignored by the receiver and set to zero by the sender.

### 11.3.61 RIM Application Identity

This information element specifies the addressed application within the target BSS node. The element coding is:

**Table 11.3.61.a: RIM Application Identity IE**

	8	7	6	5	4	3	2	1
Octet 1	IEI							
Octet 2, 2a	Length Indicator							
Octet 3	RIM Application Identity							

RIM Application Identity is coded as shown below.

**Table 11.3.61.b: RIM Application Identity coding**

Coding	Semantic
0000 0000	Reserved
0000 0001	Network Assisted Cell Change (NACC)
0000 0010	System Information 3 (SI3)
0000 0011	MBMS data channel
0000 0100	SON Transfer
0000 0101	UTRA System Information (UTRA SI)
0000 0110 - 1111 1111	Reserved

All values not allocated are reserved.

## 11.3.62 RIM Sequence Number

This information element defines the sequence number allocated to the PDU by the source node. The element coding is:

**Table 11.3.62: RIM Sequence Number IE**

	8	7	6	5	4	3	2	1
Octet 1	IEI							
Octet 2, 2a	Length Indicator							
Octet 3	RIM Sequence Number (Higher order octet)							
Octet 4	RIM Sequence Number							
Octet 5	RIM Sequence Number							
Octet 6	RIM Sequence Number (Lower order octet)							

### 11.3.62a RIM Container

#### 11.3.62a.0 General

The coding of the *RIM Container* IE value part depends on the value of the PDU type according to the following sub-clauses:

#### 11.3.62a.1 RAN-INFORMATION-REQUEST RIM Container

This information element defines the RIM container used in the RAN-INFORMATION-REQUEST PDU. The element coding is:

**Table 11.3.62a.1.a: RAN-INFORMATION-REQUEST RIM Container IE**

	8	7	6	5	4	3	2	1
Octet 1	IEI							
Octet 2, 2a	Length Indicator							
Octet 3-?	RAN-INFORMATION-REQUEST RIM Container Contents coded as defined in table 11.3.62a.1b							

**Table 11.3.62a.1.b: RAN-INFORMATION-REQUEST RIM Container Contents**

Information Elements	Type / Reference	Presence	Format	Length
RIM Application Identity	RIM Application Identity/11.3.61	M	TLV	3
RIM Sequence Number	RIM Sequence Number/11.3.62	M	TLV	6
RIM PDU Indications	RIM PDU Indications/11.3.65	M	TLV	3
RIM Protocol Version Number	RIM Protocol Version Number/11.3.67	O	TLV	3
Application Container (note 1)	RAN-INFORMATION-REQUEST Application Container/11.3.63.1	C	TLV	4-?
SON Transfer Application Identity (note 2)	SON Transfer Application Identity/11.3.108	C	TLV	3-m

NOTE 1: The presence of the Application Container depends on the value of the *RIM Application Identity* IE.

NOTE 2: The *SON Transfer Application Identity* IE shall be present if and only if the *RIM Application Identity* IE is set to "SON Transfer".



## 11.3.62a.2 RAN-INFORMATION RIM Container

This information element defines the RIM container used in the RAN-INFORMATION PDU. The element coding is:

Table 11.3.62a.2.a: RAN-INFORMATION RIM Container IE

	8	7	6	5	4	3	2	1
Octet 1	IEI							
Octet 2, 2a	Length Indicator							
Octet 3-?	RAN-INFORMATION RIM Container Contents coded as defined in table 11.3.62a.2b							

Table 11.3.62a.2.b: RAN-INFORMATION RIM Container Contents

Information Elements	Type / Reference	Presence	Format	Length
RIM Application Identity	RIM Application Identity /11.3.61	M	TLV	3
RIM Sequence Number	RIM Sequence Number /11.3.62	M	TLV	6
RIM PDU Indications	RIM PDU Indications /11.3.65.	M	TLV	3
RIM Protocol Version Number	RIM Protocol Version Number/11.3.67	O	TLV	3
Application Container (NOTE 1)	RAN-INFORMATION Application Container /11.3.63.2	C (Note 1)	TLV	4-?
Application Error Container (NOTE 1)	Application Error Container/11.3.64	C (Note 1)	TLV	n
SON Transfer Application Identity (note 2)	SON Transfer Application Identity/11.3.108	C	TLV	3-m

NOTE 1: The presence of application information depends on the value of the *RIM Application Identity* IE. If application information is mandatory either the *Application Error Container* IE or the *Application Container* IE is present.

NOTE 2: The *SON Transfer Application Identity* IE shall be present if and only if the *RIM Application Identity* IE is set to "SON Transfer".

## 11.3.62a.3 RAN-INFORMATION-ACK RIM Container

This information element defines the RIM container used in the RAN-INFORMATION-ACK PDU. The element coding is:

Table 11.3.62a.3.a: RAN-INFORMATION-ACK RIM Container IE

	8	7	6	5	4	3	2	1
Octet 1	IEI							
Octet 2, 2a	Length Indicator							
Octet 3-16	RAN-INFORMATION-ACK RIM Container Contents coded as defined in table 11.3.62a.3b							

Table 11.3.62a.3.b: RAN-INFORMATION-ACK RIM Container Contents

Information Elements	Type / Reference	Presence	Format	Length
RIM Application Identity	RIM Application Identity /11.3.61	M	TLV	3
RIM Sequence Number	RIM Sequence Number /11.3.62	M	TLV	6
RIM Protocol Version Number	RIM Protocol Version Number/11.3.67	O	TLV	4
SON Transfer Application Identity (note 1)	SON Transfer Application Identity/11.3.108	C	TLV	3-m

NOTE 1: The *SON Transfer Application Identity* IE shall be present if and only if the *RIM Application Identity* IE is set to "SON Transfer".

### 11.3.62a.4 RAN-INFORMATION-ERROR RIM Container

This information element defines the RIM container used in the RAN-INFORMATION-ERROR PDU. The element coding is:

**Table 11.3.62a.4.a: RAN-INFORMATION-ERROR RIM Container IE**

	8	7	6	5	4	3	2	1
Octet 1	IEI							
Octet 2, 2a	Length Indicator							
Octet 3-?	RAN-INFORMATION-ERROR RIM Container Contents coded as defined in table 11.3.62a.4b							

**Table 11.3.62a.4.b: RAN-INFORMATION-ERROR RIM Container Contents**

Information Elements	Type / Reference	Presence	Format	Length
RIM Application Identity	RIM Application Identity /11.3.61	M	TLV	3
RIM Cause	Cause/11.3.8	M	TLV	3
RIM Protocol Version Number	RIM Protocol Version Number/11.3.67	O	TLV	3
PDU in Error	PDU in Error/11.3.24	M	TLV	3-?
SON Transfer Application Identity (note 1)	SON Transfer Application Identity/11.3.108	C	TLV	3-m

NOTE 1: The *SON Transfer Application Identity* IE shall be present if and only if the *RIM Application Identity* IE is set to "SON Transfer".

### 11.3.62a.5 RAN-INFORMATION-APPLICATION-ERROR RIM Container

This information element defines the RIM container used in the RAN-INFORMATION-APPLICATION-ERROR PDU. The element coding is:

**Table 11.3.62a.5.a: RAN-INFORMATION-APPLICATION-ERROR RIM Container IE**

	8	7	6	5	4	3	2	1
Octet 1	IEI							
Octet 2, 2a	Length Indicator							
Octet 3-?	RAN-INFORMATION-APPLICATION-ERROR RIM Container Contents coded as defined in table 11.3.62a.5b							

**Table 11.3.62a.5.b: RAN-INFORMATION-APPLICATION-ERROR RIM Container Contents**

Information Elements	Type / Reference	Presence	Format	Length
RIM Application Identity	RIM Application Identity /11.3.61	M	TLV	3
RIM Sequence Number	RIM Sequence Number /11.3.62	M	TLV	6
RIM PDU Indications	RIM PDU Indications /11.3.65.	M	TLV	3
RIM Protocol Version Number	RIM Protocol Version Number/11.3.67	O	TLV	3
Application Error Container	Application Error Container/11.3.64	M	TLV	n
SON Transfer Application Identity (note 1)	SON Transfer Application Identity/11.3.108	C	TLV	3-m

NOTE 1: The *SON Transfer Application Identity* IE shall be present if and only if the *RIM Application Identity* IE is set to "SON Transfer".

## 11.3.63 Application Container

### 11.3.63.1 RAN-INFORMATION-REQUEST Application Container

#### 11.3.63.1.0 General

The coding of the *Application Container* value part within the RAN-INFORMATION-REQUEST RIM container depends on the value of the *RIM Application Identity* IE included into the RIM container according to the following sub-clauses.

#### 11.3.63.1.1 RAN-INFORMATION-REQUEST Application Container for the NACC Application

The coding of the *Application Container* IE within the RAN-INFORMATION-REQUEST RIM container for the NACC application is specified as follows:

**Table 11.3.63.1.1: RAN-INFORMATION-REQUEST Application Container coding for NACC**

	8	7	6	5	4	3	2	1
Octet 1	IEI							
Octet 2, 2a	Length Indicator							
Octet 3-10	Reporting Cell Identifier							

**Reporting Cell Identifier:** This field is encoded as the Cell Identifier defined in sub-clause 11.3.9

#### 11.3.63.1.2 RAN-INFORMATION-REQUEST Application Container for the SI3 Application

The coding of the *Application Container* IE within the RAN-INFORMATION-REQUEST RIM container for the SI3 application is specified as follows:

**Table 11.3.63.1.2: RAN-INFORMATION-REQUEST Application Container coding for SI3**

	8	7	6	5	4	3	2	1
Octet 1	IEI							
Octet 2, 2a	Length Indicator							
Octet 3-10	Reporting Cell Identifier							

**Reporting Cell Identifier:** This field is encoded as the Cell Identifier defined in sub-clause 11.3.9

#### 11.3.63.1.3 RAN-INFORMATION-REQUEST Application Container for the MBMS data channel Application

The coding of the *Application Container* IE within the RAN-INFORMATION-REQUEST RIM container for the MBMS data channel application is specified as follows:

**Table 11.3.63.1.3: RAN-INFORMATION-REQUEST Application Container coding for MBMS data channel**

	8	7	6	5	4	3	2	1
Octet 1	IEI							
Octet 2, 2a	Length Indicator							
Octet 3-10	Reporting Cell Identifier							

**Reporting Cell Identifier:** This field is encoded as the Cell Identifier defined in sub-clause 11.3.9

#### 11.3.63.1.4 RAN-INFORMATION-REQUEST Application Container for the SON Transfer Application

The coding of the *Application Container* IE within the RAN-INFORMATION-REQUEST RIM container for the SON Application is specified as follows:

**Table 11.3.63.1.4: RAN-INFORMATION-REQUEST Application Container coding for SON Transfer**

	8	7	6	5	4	3	2	1
Octet 1	IEI							
Octet 2, 2a	Length Indicator							
Octet 3-m	Reporting Cell Identifier							
Octet (m+1)-n	SON Transfer Request Container							

##### Reporting Cell Identifier:

- If the request concerns an E-UTRAN cell, this field is encoded as the *E-UTRAN CGI* IE as defined in 3GPP TS 36.413 [36].
- If the request concerns a UTRAN cell, this field is encoded as the *Source Cell Identifier* IE (UTRAN Source Cell ID) as defined in 3GPP TS 25.413 [38].
- If the request concerns a GERAN cell, this field is encoded as the *Cell Identifier* IE defined in sub-clause 11.3.9.
- If the request concerns an eHRPD eAN cell, this field is encoded as the *eHRPD Sector ID* IE as specified in 3GPP2 C.S0024-B [47].

**SON Transfer Request Container:** This field is encoded as the *SON Transfer Request Container* IE as defined in 3GPP TS 36.413 [36].

#### 11.3.63.1.5 RAN-INFORMATION-REQUEST Application Container for the UTRA SI Application

The coding of the *Application Container* IE within the RAN-INFORMATION-REQUEST RIM container for the UTRA SI application is specified as follows:

**Table 11.3.63.1.5: RAN-INFORMATION-REQUEST Application Container coding for UTRA SI**

	8	7	6	5	4	3	2	1
Octet 1	IEI							
Octet 2, 2a	Length Indicator							
Octet 3-m	Reporting Cell Identifier							

**Reporting Cell Identifier:** This field is encoded as the *Source Cell Identifier* IE (UTRAN Source Cell ID) as defined in 3GPP TS 25.413 [38].

## 11.3.63.2 RAN-INFORMATION Application Container Unit

### 11.3.63.2.0 General

The coding of the *Application Container* value part within the RAN-INFORMATION RIM container depends on the value of the *RIM Application Identity* IE included into the RIM container according to the following sub-clauses.

#### 11.3.63.2.1 RAN-INFORMATION Application Container for the NACC Application

The coding of the *Application Container* IE within the RAN-INFORMATION RIM container for the NACC application is specified as follows:

**Table 11.3.63.2.1.a: RAN-INFORMATION Application Container coding for NACC**

	8	7	6	5	4	3	2	1
Octet 1	IEI							
Octet 2, 2a	Length Indicator							
Octet 3-10	Reporting Cell Identifier							
Octet 11	Number of SI/PSI							Type
Octet 12-n	SI/PSI							

**Reporting Cell Identifier:** This field is encoded as the value part of the Cell Identifier IE defined in sub-clause 11.3.9, not including IEI and Length Indicator.

**Type:** This field indicates the type of SI/PSI messages provided by the reporting cell. The *Type* field is coded as shown below:

**Table 11.3.63.2.1.b: Type coding**

Coding	Semantic
0	SI messages as specified for BCCH (3GPP TS 44.018) follow
1	PSI messages as specified for PBCCH (3GPP TS 44.060) follow

**Number of SI/PSI:** This field indicates the number of SI/PSI provided by the reporting cell contained in the *SI/PSI field*. This number may be zero. For system information messages with multiple instances, each instance is counted as one SI/PSI message. The *Number of SI/PSI* field is coded as shown below:

**Table 11.3.63.2.1.c: Number of SI/PSI coding**

Coding	Semantic
000 0000	0 "SI/PSI" follows
000 0001	1 "SI/PSI" follow
'	"
111 1111	127 "SI/PSI" follow

**SI/PSI:** This field contains a list of either system information or packet system information messages valid for the reporting cell. The number of (packet) system information messages is indicated in the *Number of SI/PSI* field specified above. Furthermore:

- If the *Type* field indicates that "SI messages as specified for BCCH (3GPP TS 44.018) follow" then the *SI/PSI* field contains System Information message instances encoded for BCCH as specified in 3GPP TS 44.018. Each System Information message contains the *Message type* octet followed by all the IEs composing the message payload. Each message is 21 octets long.
- If the *Type* field indicates that "PSI messages as specified for PBCCH (3GPP TS 44.060) follow" then the *SI/PSI* field contains Packet System Information message instances encoded for PBCCH as specified in 3GPP TS 44.060. Each Packet System Information message contains the *MESSAGE\_TYPE* field followed by the PSI message content. Each message is 22 octets long.

### 11.3.63.2.2 RAN-INFORMATION Application Container for the SI3 Application

The coding of the value part of the *Application Container* IE within the RAN-INFORMATION RIM container for the SI3 application is specified as follows:

**Table 11.3.63.2.2: RAN-INFORMATION Application Container coding for SI3**

	8	7	6	5	4	3	2	1
Octet 1	IEI							
Octet 2, 2a	Length Indicator							
Octet 3-10	Reporting Cell Identifier							
Octet 11-31	SI3							

**Reporting Cell Identifier:** The parameter is encoded as the value part of the Cell Identifier IE defined in sub-clause 11.3.9, not including IEI and Length Indicator.

**SI3:** contains the SYSTEM INFORMATION type 3 message encoded for BCCH as specified in 3GPP TS 44.018. It contains the *Message type* octet followed by all the IEs composing the message payload. The message is 21 octets long.

### 11.3.63.2.3 RAN-INFORMATION Application Container for the MBMS data channel Application

The coding of the *Application Container* IE within the RAN-INFORMATION RIM container for the MBMS data channel application is specified as follows :

**Table 11.3.63.2.3.a: RAN-INFORMATION Application Container coding for MBMS data channel**

	8	7	6	5	4	3	2	1
Octet 1	IEI							
Octet 2, 2a	Length Indicator							
Octet 3-10	Reporting Cell Identifier							
Octet 11-n	MBMS data channel report							

**Reporting Cell Identifier:** This field is encoded as the value part of the Cell Identifier IE defined in sub-clause 11.3.9, not including IEI and Length Indicator.

**MBMS data channel report:** This field contains a CSN1 encoded structure coded as shown below:

Table 11.3.63.1.3.b: MBMS data channel report

```

< MBMS data channel report struct > ::=
{ 1 < MBMS Frequency List : < MBMS Frequency List struct > > } **0

{ 1
  < MBMS p-t-m Frequency Parameters : < MBMS p-t-m Frequency Parameters struct > >
  < DOWNLINK_TIMESLOT_ALLOCATION : bit (8) > --default value common to all described bearer Id using this
frequency allocation
  { 1
    < TMGI : < TMGI IE >> -- MBMS service identifier
    { 0 | 1 < MBMS Session Identity: bit(8) > } -- session identifier of the particular MBMS service
    < Length of MBMS Bearer Identity : bit (3) >
    < MBMS Bearer Identity : bit (val (Length of MBMS Bearer Identity)) >
    { 0 | 1 < EGPRS Window Size : < EGPRS Window Size IE >> }
    { 0 | 1 < DOWNLINK_TIMESLOT_ALLOCATION : bit (8) > } -- dedicated value for this bearer, overwrites the
default value
    { 0 | 1 <TIMESLOT_ALLOCATION_UPLINK_FEEDBACK_CHANNEL : bit (3) > }
    { 0 | 1 < MBMS Radio Bearer Starting Time : < bit (16) >> }
    < MBMS In-band Signalling Indicator : < MBMS In-band Signalling Indicator IE >>
    { 0 | 1 < NPM Transfer Time : bit (5) > }
  } **0 -- End of list of MBMS bearer identifiers sharing the same PDCH (frequency parameters)
} **0 -- End of list of PDCHs for this cell
{ null | 0 bit** = < no string >
  | 1 -- Rel-7 Additions
  { 1
    { 0 | 1 < USF : bit (3) > --choice bit indicates presence or not of parameters for the MBMS bearer
    { 0 | 1 < MPRACH Control Parameters : < MPRACH Control Parameters IE >> }
  }
  } **0 -- End of list of MBMS bearers. The list of MBMS bearers is ordered as described by the loops
in the earlier releases part.
}
< padding bits > -- to fill the last octet

```

**MBMS Frequency List:** This field contains a *MBMS Frequency List struct* as specified in 3GPP TS 44.060

**MBMS p-t-m Frequency Parameters:** This field contains a *MBMS p-t-m Frequency Parameters struct* as specified in 3GPP TS 44.060

**DOWNLINK\_TIMESLOT\_ALLOCATION:** This field contains a *DOWNLINK\_TIMESLOT\_ALLOCATION* field as specified in 3GPP TS 44.060

**TMGI:** This field contains a *TMGI IE* as specified in 3GPP TS 44.060

**MBMS Session Identity:** This field contains a *MBMS Session Identity* field as specified in 3GPP TS 44.060

**MBMS Bearer Identity:** This field contains a *MBMS Bearer Identity IE* as specified in 3GPP TS 44.060

**EGPRS Window Size:** This field contains a *EGPRS Window Size IE* as specified in 3GPP TS 44.060

**TIMESLOT\_ALLOCATION\_UPLINK\_FEEDBACK\_CHANNEL:** This field contains a *TIMESLOT\_ALLOCATION\_UPLINK\_FEEDBACK\_CHANNEL* field as specified in 3GPP TS 44.060

**MBMS Radio Bearer Starting Time:** This field is encoded as value part of the type 3 information element *Starting Time* in 3GPP TS 44.018.

**MBMS In-band Signalling Indicator:** This field contains a *MBMS In-band Signalling Indicator IE* as specified in 3GPP TS 44.060. **NPM Transfer Time:** This field contains a *NPM Transfer Time IE* as specified in 3GPP TS 44.060. **USF:** This field contains a *USF* field as specified in 3GPP TS 44.060

**MPRACH Control Parameters:** This field contains a *MPRACH Control Parameters IE* as specified in 3GPP TS 44.060.

### 11.3.63.2.4 RAN-INFORMATION Application Container for the SON Transfer Application

The coding of the *Application Container* IE within the RAN-INFORMATION RIM container for the SON Transfer Application is specified as follows :

**Table 11.3.63.2.4: RAN-INFORMATION Application Container coding for SON Transfer**

	8	7	6	5	4	3	2	1
Octet 1	IEI							
Octet 2, 2a	Length Indicator							
Octet 3	Spare				RAT discriminator			
Octet 4-m	Reporting Cell Identifier							
Octet (m+1)-n	SON Transfer Response Container							

The coding of *RAT discriminator* (bits 4 to 1 of octet 3) is a binary number indicating the RAT of the Reporting Cell Identifier. The *RAT discriminator* is coded as follows:

Bits	
<b>4321</b>	
<b>0000</b>	The reporting RAT is GERAN.
<b>0001</b>	The reporting RAT is UTRAN.
<b>0010</b>	The reporting RAT is E-UTRAN.
<b>0011</b>	The reporting RAT is eHRPD eAN

All other values are reserved.

#### Reporting Cell Identifier:

- If the *RAT discriminator* field indicates E-UTRAN, this field is encoded as the *E-UTRAN CGI* IE as defined in 3GPP TS 36.413 [36].
- If the *RAT discriminator* field indicates UTRAN, this field is encoded as the *Source Cell Identifier* IE (UTRAN Source Cell ID) as defined in 3GPP TS 25.413 [38].
- If the *RAT discriminator* field indicates GERAN, this field is encoded as the value part of the *Cell Identifier* IE defined in sub-clause 11.3.9, not including IEI and Length Indicator.
- If the *RAT discriminator* field indicates eHRPD, this field is encoded as *eHRPD Sector ID* IE as defined in 3GPP2 C.S0024-B [47].

**SON Transfer Response Container:** This field is encoded as the *SON Transfer Response Container* IE as defined in 3GPP TS 36.413 [36].

### 11.3.63.2.5 RAN-INFORMATION Application Container for the UTRA SI Application

The coding of the *Application Container* IE within the RAN-INFORMATION RIM container for the UTRA SI application is specified as follows:

**Table 11.3.63.2.5: RAN-INFORMATION Application Container coding for UTRA SI**

	8	7	6	5	4	3	2	1
Octet 1	IEI							
Octet 2, 2a	Length Indicator							
Octet 3-m	Reporting Cell Identifier							
Octet (m+1)-n	UTRA SI Container							

**Reporting Cell Identifier:** This field is encoded as the *Source Cell Identifier* IE (UTRAN Source Cell ID) as defined in 3GPP TS 25.413 [38].

**UTRA SI Container:** This field contains System Information Container valid for the reporting cell encoded as defined in TS 25.331 [42].



## 11.3.64 Application Error Container

### 11.3.64.1 Application Error Container layout for the NACC application

The coding of the *Application Error Container* IE for the NACC application is specified as follows:

**Table 11.3.64.1.a: Application Error Container coding for NACC**

	8	7	6	5	4	3	2	1
Octet 1	IEI							
Octet 2, 2a	Length Indicator							
Octet 3	NACC Cause							
Octet 4-n	Erroneous Application Container including IEI and LI							

**NACC Cause:** This field indicates the cause why the *Application Error Container* IE is sent. The *NACC Cause* field is coded as shown below:

**Table 11.3.64.1.b: NACC Cause coding**

Coding	Semantic
0000 0000	Other unspecified error
0000 0001	Syntax error in the Application Container
0000 0010	Reporting Cell Identifier does not match with the Destination Cell Identifier or with the Source Cell Identifier.
0000 0011	SI/PSI type error
0000 0100	Inconsistent length of a SI/PSI message
0000 0101	Inconsistent set of messages
Other values	reserved

**"Other unspecified error":** none of the error description below fits with the detected error

**"Syntax error in the Application Container":** the *Application Container* IE is syntactically incorrect

**"Reporting Cell Identifier does not match with the Destination Cell Identifier or with the Source Cell Identifier":** the *Reporting Cell Identifier* in the *Application Container* IE does not match with the *Destination Cell Identifier* IE value (in the case of a RAN-INFORMATION-REQUEST PDU) or with the *Source Cell Identifier* IE value (in the case of a RAN-INFORMATION PDU) of the RIM PDU

**"SI/PSI type error":** the *Application Container* IE contains system information messages instead of packet system information messages or conversely

**"Inconsistent length of a SI/PSI message":** the length contained in one SI/PSI message does not fit with the content of the message

**"Inconsistent set of messages":** the status of the change marks reported in the (packet) system information message set is inconsistent

**Erroneous Application Container:** this field contains the erroneous *Application Container* IE

### 11.3.64.2 Application Error Container for the SI3 application

The coding of the *Application Error Container* IE for the SI3 application is specified as follows:

**Table 11.3.64.2.a: Application Error Container coding for SI3**

	8	7	6	5	4	3	2	1
Octet 1	IEI							
Octet 2, 2a	Length Indicator							
Octet 3	SI3 Cause							
Octet 4-n	Erroneous Application Container including IEI and LI							

**SI3 Cause:** This field indicates the cause why the *Application Error Container* IE is sent. The *SI3 Cause* field is coded as shown below:

**Table 11.3.64.2.b: SI3 Cause coding**

Coding	Semantic
0000 0000	Other unspecified error
0000 0001	Syntax error in the Application Container
0000 0010	Reporting Cell Identifier does not match with the Destination Cell Identifier or with the Source Cell Identifier.
0000 0011	Inconsistent length of a SI3 message
Other values	Reserved

**"Other unspecified error":** None of the error description below fits with the detected error;

**"Syntax error in the Application Container":** the Error Application Container is syntactically incorrect;

**"Reporting Cell Id does not match with the Destination Cell Identifier or with the Source Cell Identifier":** the *Reporting Cell Identifier* in the *Application Container* IE does not match with the *Destination Cell Identifier* IE value (in the case of a RAN-INFORMATION-REQUEST PDU) or with the *Source Cell Identifier* IE value (in the case of a RAN-INFORMATION PDU) of the RIM PDU;

**"Inconsistent length of a SI3 message":** the length contained in the SI3 message does not fit with the content of the message;

**Erroneous Application Container:** This field contains the erroneous *Application Container* IE.

### 11.3.64.3 Application Error Container for the MBMS data channel application

The coding of the *Application Error Container* IE for the MBMS data channel application is specified as follows:

**Table 11.3.64.3.a: Application Error Container coding for MBMS data channel**

	8	7	6	5	4	3	2	1
Octet 1	IEI							
Octet 2, 2a	Length Indicator							
Octet 3	MBMS data channel Cause							
Octet 4-n	Erroneous Application Container including IEI and LI							

**MBMS data channel Cause:** This field indicates the cause why the *Application Error Container* IE is sent. The *MBMS data channel Cause* field is coded as shown below:

**Table 11.3.64.3.b: MBMS DATA CHANNEL Cause coding**

Coding	Semantic
0000 0000	Other unspecified error
0000 0001	Syntax error in the Application Container
0000 0010	Reporting Cell Identifier does not match with the Destination Cell Identifier or with the Source Cell Identifier.
0000 0011	RAN-INFORMATION/Initial Multiple Report or RAN-INFORMATION/Single Report PDU exceeds the maximum supported length
0000 0100	Inconsistent MBMS data channel description
Other values	reserved

**"Other unspecified error":** None of the error description below fits with the detected error.

**"Syntax error in the Application Container":** the *Application Container* IE is syntactically incorrect.

**"Reporting Cell Id does not match with the Destination Cell Identifier or Source Cell Identifier respectively":** the *Reporting Cell Identifier* in the *Application Container* IE does not match with the *Destination Cell Identifier* IE value (in the case of a RAN-INFORMATION-REQUEST PDU) or with the *Source Cell Identifier* IE value (in the case of a RAN-INFORMATION PDU) of the RIM header.

**"RAN-INFORMATION/Initial Multiple Report or RAN-INFORMATION/Single Report PDU exceeds the maximum supported length":** the RAN-INFORMATION/Initial Multiple Report PDU exceeds the maximum length supported by the system.

**"Inconsistent MBMS data channel description":** failure in a MBMS data channel description.

**Erroneous Application Container:** This field contains the erroneous *Application Container* IE .

#### 11.3.64.4 Application Error Container for the SON Transfer Application

The coding of the *Application Error Container* IE for the SON Transfer Application is specified as follows:

**Table 11.3.64.4: Application Error Container coding for SON Transfer**

	8	7	6	5	4	3	2	1
Octet 1	IEI							
Octet 2, 2a	Length Indicator							
Octet 3-m	SON Transfer Cause							
Octet (m+1)-n	Erroneous Application Container including IEI and LI							

**SON Transfer Cause:** This field indicates the cause why the *Application Error Container* IE is sent. The "*SON Transfer Cause*" field is encoded as the *SON Transfer Cause* IE as defined in 3GPP TS 36.413 [36].

#### 11.3.64.5 Application Error Container for the UTRA SI Application

The coding of the *Application Error Container* IE for the UTRA SI Application is specified as follows:

**Table 11.3.64.5.a: Application Error Container coding for UTRA SI**

	8	7	6	5	4	3	2	1
Octet 1	IEI							
Octet 2, 2a	Length Indicator							
Octet 3	UTRA SI Cause							
Octet 4-n	Erroneous Application Container including IEI and LI							

**UTRA SI Cause:** This field indicates the cause why the *Application Error Container* IE is sent. The *UTRA SI Cause* field is coded as shown below:

**Table 11.3.64.5.b: UTRA SI Cause coding**

Coding	Semantic
0000 0000	Unspecified
0000 0001	Syntax Error in the Application Container
0000 0010	Inconsistent Reporting Cell Identifier
Other values	Reserved

**"Unspecified":** Sent when none of the above cause values applies.

**"Syntax Error in the Application Container":** The *Application Container* IE is syntactically incorrect.

**"Inconsistent Reporting Cell Identifier":** The cell identified by *Reporting Cell Identifier* in the *Application Container* IE is unknown in the RNC identified by the *Destination Cell Identifier* IE value in the RAN-INFORMATION-REQUEST PDU.

**Erroneous Application Container:** This field contains the erroneous *Application Container* IE.

## 11.3.65 RIM PDU Indications

### 11.3.65.0 General

This information element contains various indications related to a RAN-INFORMATION-REQUEST PDU, RAN-INFORMATION PDU or RAN-INFORMATION-APPLICATION-ERROR PDU.

The element coding is:

**Table 11.3.65.a: RIM PDU Indications IE**

	8	7	6	5	4	3	2	1
Octet 1	IEI							
Octet 2, 2a	Length Indicator							
Octet 3	Reserved				PDU Type Extension			ACK

**ACK:** this field indicates whether the source side is requesting a RAN-INFORMATION-ACK PDU as response to a RAN-INFORMATION or to a RAN-INFORMATION-APPLICATION-ERROR PDU. This field is coded as shown below.

**Table 11.3.65.b: ACK coding**

Coding	Semantic
0	No ACK requested
1	ACK requested

**PDU Type Extension:** This field specifies the type extension of the PDU. The defined values depend on the PDU type.

### 11.3.65.1 RAN-INFORMATION-REQUEST RIM PDU Indications

The *ACK* field is not used and shall be considered as spare.

The following values of the *PDU Type Extension* field are defined:

**Table 11.3.65.1: RAN-INFORMATION-REQUEST PDU Type Extension coding**

Coding	Semantic
000	RAN-INFORMATION-REQUEST/Stop PDU
001	RAN-INFORMATION-REQUEST/Single Report PDU
010	RAN-INFORMATION-REQUEST/Multiple Report PDU
011	Reserved
100	Reserved
101	Reserved
110	Reserved
111	Reserved

### 11.3.65.2 RAN-INFORMATION RIM PDU Indications

The *ACK* field is defined as specified in sub-clause 11.3.65.0.

The following values of the *PDU Type Extension* field are defined:

**Table 11.3.65.2: RAN-INFORMATION PDU Type Extension coding**

<b>Coding</b>	<b>Semantic</b>
000	RAN-INFORMATION/Stop PDU
001	RAN-INFORMATION/Single Report PDU
010	RAN-INFORMATION/Initial Multiple Report PDU
011	RAN-INFORMATION/Multiple Report PDU
100	RAN-INFORMATION/End PDU
101	Reserved
110	Reserved
111	Reserved

### 11.3.65.3 RAN-INFORMATION-APPLICATION-ERROR RIM PDU Indications

The *ACK* field is defined as specified in sub-clause 11.3.65.0.

The *PDU Type Extension* field is not used and shall be considered as spare.

### 11.3.66 (void)

### 11.3.67 RIM Protocol Version Number

This information element defines which version number of the RIM protocol is in use in the PDU. The element coding is:

**Table 11.3.67.a: RIM Protocol Version Number IE**

	<b>8</b>	<b>7</b>	<b>6</b>	<b>5</b>	<b>4</b>	<b>3</b>	<b>2</b>	<b>1</b>
Octet 1	IEI							
Octet 2, 2a	Length Indicator							
Octet 3	RIM Protocol Version Number							

RIM Protocol Version Number is coded as follows:

**Table 11.3.67.b: RIM Protocol Version Number IE coding**

<b>Coding</b>	<b>Semantic</b>
0000 0000	Reserved
0000 0001	Version 1
Other values	Reserved

If this Information Element is omitted the value "Version 1" should be assumed.

### 11.3.68 PFC Flow Control parameters

This information element contains the flow control parameters for one or more PFC(s) of a certain MS. The element coding is:

**Table 11.3.68.a: PFC Flow Control parameters IE**

	8	7	6	5	4	3	2	1
octet 1	IEI							
octet 2, 2a	Length Indicator							
octet 3	Number of PFCs							
Octet 4	PFI (1)							
Octet 5-6	Bmax_PFC (1)							
Octet 7-8	R_PFC (1)							
Octet 9	B_PFC (1)							
Octet ?	PFI (2)							
Octet ?-?	Bmax_PFC (2)							
Octet ?-?	R_PFC (2)							
Octet ?	B_PFC (2)							
"	"							
Octet ?	PFI (n)							
Octet ?-?	Bmax_PFC (n)							
Octet ?-?	R_PFC (n)							
Octet ?	B_PFC (n)							

**Number of PFCs:** Number of PFCs for which flow control parameters are provided. For each of those PFCs follows its identifier and the value of the flow control parameters. The "Number of PFCs" parameter is coded as shown below:

**Table 11.3.68.b: Number of PFCs**

Coding	Semantic
0000 0000	0 PFC
0000 0001	1 PFC
...	...
0000 1011	11 PFCs
0000 1100	Reserved
'	"
1111 1111	Reserved

**PFI:** Packet Flow Identifier. Coded as the value part of the Packet Flow Identifier information element in 3GPP TS 24.008, not including 3GPP TS 24.008 IEI.

**Bmax\_PFC:** Bucket size of the PFC. Coded like the value part of BVC Bucket Size, see sub-clause 11.3.5.

**R\_PFC:** Bucket Leak Rate of the PFC. Coded as the value part of Bucket Leak Rate (R), see sub-clause 11.3.4.

**B\_PFC:** Bucket Full Ratio of the PFC. This field is only present if the Current Bucket Level (CBL) feature is negotiated. Otherwise, the flow control parameters for the next PFC, if any, are provided instead. This field is coded as the value part of the Bucket Full Ratio, see sub-clause 11.3.46.

### 11.3.69 Global CN-Id

The Global CN-Id consists of a PLMN-Id and a CN-Id, see 3GPP TS 23.003. The value part of the Global CN-Id is coded as defined in 3GPP TS 29.018. The CN-Id is an integer defined by O&M. The element coding is:

**Table 11.3.69: Global CN-Id IE**

	8	7	6	5	4	3	2	1
octet 1	IEI							
octet 2, 2a	Length Indicator							
octet 3-7	Coded as octets 3 to 7 of the Global CN-Id IE, defined in 3GPP TS 29.018							

### 11.3.70 RIM Routing Information

This information element uniquely identifies either a cell within a GERAN BSS, a UTRAN RNC, an E-UTRAN eNodeB or an eHRPD eAN. The element coding is:

**Table 11.3.70: RIM Routing Information IE**

	8	7	6	5	4	3	2	1
octet 1	IEI							
octet 2, 2a	Length Indicator							
octet 3	Spare				RIM Routing Address discriminator			
octet 4-n	RIM Routing Address							

The coding of *RIM Routing Address discriminator* (bits 4 to 1 of octet 3) is a binary number indicating which type of address is provided in octet 4-n. The *RIM Routing Address discriminator* is coded as follows:

Bits	
<b>4321</b>	
<b>0000</b>	A Cell Identifier is used to identify a GERAN cell.
<b>0001</b>	An RNC identifier is used to identify a UTRAN RNC.
<b>0010</b>	An eNB identifier is used to identify an E-UTRAN eNodeB or HeNB
<b>0011</b>	An eHRPD Sector ID is used to identify an eHRPD eAN

All other values are reserved.

The coding of octet 4-n depends on the *RIM Routing Address discriminator* (octet 3) as it is specified below.

**RIM Routing Address discriminator = 0000:**

The *RIM Routing Address* field contains a Cell Identifier and is coded as the value part (octet 3 to octet 10) of the *Cell Identifier* information element specified in sub-clause 11.3.9.

**RIM Routing Address discriminator = 0001:**

The *RIM Routing Address* field contains an RNC identifier and is coded as follows:

8	7	6	5	4	3	2	1	
Octets 4 to 9 contain the value part (starting with octet 2) of the <i>Routing Area Identification</i> IE defined in 3GPP TS 24.008, not including 3GPP TS 24.008 IEI								octets 4-9
RNC-ID (or Extended RNC-ID)								octet 10
RNC-ID (or Extended RNC-ID) (continued)								octet 11

The octets 10-11 contain the RNC-ID (0..4095) or the Extended RNC-ID (4096..65535) - see 3GPP TS 25.413:

- The least significant bit of RNC-ID is octet 11 bit 1 and most significant bit is octet 10 bit 4. In the octet 10 bits 5-8 are set to "0000".
- The least significant bit of Extended RNC-ID is octet 11 bit 1 and most significant bit is octet 10 bit 8.

**RIM Routing Address discriminator = 0010:**

The *RIM Routing Address* field contains an eNB identifier and is coded as follows:

8	7	6	5	4	3	2	1	
Octets 4 to 8 contain the value part (starting with octet 2) of the <i>Tracking Area Identity</i> IE defined in 3GPP TS 24.301 [37], not including 3GPP TS 24.301 IEI [37]								octet 4-8
Global eNB ID								octet 9-n

Octets 9-n contain the Global eNB ID (see 3GPP TS 36.413 [36] sub-clause 9.3.4, *Global-ENB-ID* Sequence) of the eNodeB.

#### **RIM Routing Address discriminator = 0011:**

The *RIM Routing Address* field contains an eHRPD evolved Access Network identifier and is coded as follows:

8	7	6	5	4	3	2	1	
eHRPD Sector ID								octet 4-n

Octets 4-n contain the eHRPD Sector ID defined in 3GPP2 C.S0024-B [47].

### 11.3.71 MBMS Session Identity

The MBMS Session Identity is an identification of the MBMS Session as defined in 3GPP TS 23.246 [32]. The element coding is:

**Table 11.3.71: MBMS Session Identity IE**

	8	7	6	5	4	3	2	1	
octet 1	IEI								
octet 2, 2a	Length Indicator								
octet 3	MBMS-Session-Identity AVP encoded as in 3GPP TS 29.061 [31], excluding AVP Header fields as defined in IETF RFC 3588 [33].								

### 11.3.72 MBMS Session Duration

The MBMS Session Duration defines the (remaining) duration of the MBMS Session as defined in 3GPP TS 23.246 [32]. The element coding is:

**Table 11.3.72: MBMS Session Duration IE**

	8	7	6	5	4	3	2	1	
octet 1	IEI								
octet 2, 2a	Length Indicator								
octet 3-m	MBMS-Session-Duration AVP encoded as in 3GPP TS 29.061 [31], excluding AVP Header fields as defined in IETF RFC 3588 [33].								



### 11.3.73 MBMS Service Area Identity List

The MBMS Service Area Identity List identifies the Service Areas Identities for the Service Areas where the MBMS Session shall be active as defined in 3GPP TS 29.061. The element coding is:

**Table 11.3.73: MBMS Service Area Identity List IE**

	<b>8</b>	<b>7</b>	<b>6</b>	<b>5</b>	<b>4</b>	<b>3</b>	<b>2</b>	<b>1</b>
octet 1	IEI							
octet 2, 2a	Length Indicator							
octet 3 - 514	MBMS-Service-Area AVP encoded as in 3GPP TS 29.061, excluding AVP Header fields (as defined in IETF RFC 3588 [33]).							

### 11.3.74 MBMS Response

The MBMS Response identifies the Cause Values from the BSS regarding MBMS.

**Table 11.3.74.a: MBMS Response IE**

	<b>8</b>	<b>7</b>	<b>6</b>	<b>5</b>	<b>4</b>	<b>3</b>	<b>2</b>	<b>1</b>
Octet 1	IEI							
Octet 2, 2a	Length Indicator							
Octet 3	Spare	Spare	Spare	Spare	Cause Value			

**Table 11.3.74.b: Cause Value**

(octet 3)	
Bits	8 7 6 5 Spare
Bits	
4 3 2 1	
0 0 0 0	Acknowledge
0 0 0 1	Acknowledge, initiate data transfer
0 0 1 0	Acknowledge, data transfer initiated from other SGSN
0 0 1 1	Reject - Congestion
0 1 0 0	Reject - None of the listed MBMS Service Areas are supported by BSS
0 1 0 1	Reject - MBMS Service Context is released due to interrupted data flow
0 1 1 0	
:	Unspecified in this version of the protocol
1 1 1 1	

### 11.3.75 MBMS Routing Area List

The MBMS Routing Area List identifies each Routing Area that contains at least one PMM-IDLE MS that has activated the MBMS bearer service. The list may be empty.

**Table 11.3.75.a: MBMS Routing Area List IE**

	8	7	6	5	4	3	2	1
octet 1	IEI							
octet 2, 2a	Length Indicator							
octet 3	Number of Routing Area Identifications				Spare	Spare	Spare	Spare
octet 4 - 11	Routing Area Identification 1							
octet 12 - 19	Routing Area Identification 2							
octet 20 - 27	Routing Area Identification 3							
octet 28 - 35	Routing Area Identification 4							
octet 36 - 43	Routing Area Identification 5							
octet 44 - 51	Routing Area Identification 6							
octet 52 - 59	Routing Area Identification 7							
octet 60 - 67	Routing Area Identification 8							
octet 68 - 75	Routing Area Identification 9							
octet 76 - 83	Routing Area Identification 10							
octet 84 - 91	Routing Area Identification 11							
octet 92 - 99	Routing Area Identification 12							
octet 100 - 107	Routing Area Identification 13							
octet 108 - 115	Routing Area Identification 14							

**Table 11.3.75.b: MBMS Routing Area List information element details**

<p><b>Number of Routing Areas</b> (octet 3)</p> <p><b>8 7 6 5</b></p> <p>0 0 0 0 Notification shall not be sent to any Routing Areas in the BSS</p> <p>0 0 0 1 "1" Routing Area Identities</p> <p>:</p> <p>:</p> <p>1 1 1 0 "14" Routing Area Identities</p> <p>1 1 1 1 Notification shall be sent in all Routing Areas in the BSS</p> <p><b>4 3 2 1</b> (octet 3)</p> <p>Spare</p>
<p><b>Routing Area Identification i</b> 7 octets (octet 4, 12, 20, 28, 36, 44, 52, 60, 68, 76, 84, 92, 100 and 108)</p> <p>The element is coded as the Routing Area Identification information element in 3GPP TS 24.008, not including 3GPP TS 24.008 IEI and 3GPP TS 24.008 length indicator.</p>

### 11.3.76 MBMS Session Information

The MBMS Session Information carries information about the MBMS Session from the SGSN to the BSS.

**Table 11.3.76.a: MBMS Session Information IE**

	8	7	6	5	4	3	2	1
octet 1	IEI							
octet 2, 2a	Length Indicator							
octet 3	Spare	Spare	Spare	Spare	Spare	Spare	Spare	BC/MC

**Table 11.3.76.b: MBMS Session Information information element details**

<p><b>BC/MC</b> (octet 3)                  This field indicates whether it is a Broadcast or an Multicast MBMS Session.                  Bit  <b>1</b>                  0 Broadcast Session                  1 Multicast Session</p> <p><b>8 7 6 5 4 3 2</b> (octet 3)                  Spare</p>
---

### 11.3.77 TMGI (Temporary Mobile Group Identity)

The purpose of TMGI is for group paging in MBMS as defined in 3GPP TS 24.008.

**Table 11.3.77: TMGI IE**

	8	7	6	5	4	3	2	1
octet 1	IEI							
octet 2,2a	Length Indicator							
octet 3-8	Rest of element coded as in 3GPP TS 24.008, not including 3GPP TS 24.008 IEI and 3GPP TS 24.008 length indicator.							

### 11.3.78 MBMS Stop Cause

The MBMS Stop Cause identifies the Cause Values for stopping an MBMS Session.

**Table 11.3.74.a: MBMS Stop Cause IE**

	8	7	6	5	4	3	2	1
Octet 1	IEI							
Octet 2, 2a	Length Indicator							
Octet 3	Spare	Spare	Spare	Spare	Cause Value			

**Table 11.3.74.b: Cause Value**

(octet 3)	
Bits	8 7 6 5 Spare
Bits	
4 3 2 1	
0 0 0 0	MBMS Session terminated by upstream node
0 0 0 1	MBMS Session terminated by SGSN
0 0 1 0	
:	Unspecified in this version of the protocol
1 1 1 1	

## 11.3.79 Source BSS to Target BSS Transparent Container

This information element contains the information needed in the Target BSS to execute a PS Handover.

The element coding is:

**Table 11.3.79.a: Source BSS to Target BSS Transparent Container coding**

	<b>8</b>	<b>7</b>	<b>6</b>	<b>5</b>	<b>4</b>	<b>3</b>	<b>2</b>	<b>1</b>
Octet 1	IEI							
Octet 2, 2a	Length Indicator							
Octet 3-?	Source BSS to Target BSS Transparent Container Contents coded as defined in table 11.3.79.b							

**Table 11.3.79.b: Source BSS to Target BSS Transparent Container Contents**

Information Elements	Type / Reference	Presence	Format	Length
MS Radio Access Capability	MS Radio Access Capability/11.3.22	M	TLV	7-?
Inter RAT Handover Info	Inter RAT Handover Info/11.3.94	O (note 1)	TLV	3-?
Page Mode	Page Mode/11.3.88	O (note 2, note 3)	TLV	3
Container ID	Container ID/11.3.89	O (note 2)	TLV	3
Global TFI	Global TFI/11.3.90	O (note 2, note 3)	TLV	3
PS Handover Indications	PS Handover Indications/11.3.95a	O	TLV	3
CS Indication	CS Indication/11.3.98	O (note 3)	TLV	3
E-UTRAN Inter RAT Handover Info	E-UTRAN Inter RAT Handover Info/11.3.104	O (note 1)	TLV	3-?
IRAT Measurement Configuration	IRAT Measurement Configuration/11.3.115	O (note 4)	TLV	3-?
Source Cell ID	Source Cell ID/11.3.120	O (note 4, note 5)	TLV	8-?
IRAT Measurement Configuration (extended E-ARFCNs)	IRAT Measurement Configuration (extended E-ARFCNs)/11.3.121	O (note 4)	TLV	3-?
NOTE1: This information element shall be present if available in the source BSS. NOTE2: This information element shall be present in case of PS Handover from A/Gb mode. NOTE3: This information element shall be present in case of DTM Handover from A/Gb mode. NOTE4: This information element may be present in case of PS Handover from E-UTRAN (see 3GPP TS 36.413 [36]) NOTE 5: This information element shall be present in case either the <i>IRAT Measurement Configuration</i> information element or the <i>IRAT Measurement Configuration (extended E-ARFCNs)</i> information element is present.				

## 11.3.80 Target BSS to Source BSS Transparent Container

This information element contains the information needed in the Source BSS to execute a PS Handover.

The element coding is:

**Table 11.3.80.a: Target BSS to Source BSS Transparent Container coding**

	<b>8</b>	<b>7</b>	<b>6</b>	<b>5</b>	<b>4</b>	<b>3</b>	<b>2</b>	<b>1</b>
Octet 1	IEI							
Octet 2 2a	Length Indicator							
Octet 3-?	Target BSS to Source BSS Transparent Container Contents coded as defined in table 11.3.80.b							

**Table 11.3.80.b: Target BSS to Source BSS Transparent Container Contents**

Information Elements	Type / Reference	Presence	Format	Length
PS Handover Command	PS Handover Command/11.3.95	O (Note 2)	TLV	4-?
SI/PSI Container	SI/PSI Container/11.3.95b	O (Note 1)	TLV	3-?
DTM Handover Command	DTM Handover Command/11.3.97	O (Note 2)	TLV	22-?
NOTE 1: This information element shall be included when requested in the PS-HANDOVER-REQUEST PDU.				
NOTE 2: Only one of these information elements shall be included.				

### 11.3.81 NAS container for PS Handover

This information element contains the NAS container for PS Handover. The value part of this IE is to be included in the PS Handover Command message within the *Target BSS to Source BSS Transparent Container* IE.

The element coding is:

**Table 11.3.81: NAS container for PS Handover coding**

	8	7	6	5	4	3	2	1
Octet 1	IEI							
Octet 2, 2a	Length Indicator							
Octets 3-?	NAS container for PS HO coded as defined in 3GPP TS 24.008							

### 11.3.82 PFCs to be set-up list

This information element contains the Packet Flow Context parameters for one or more PFC(s), that the SGSN requests the target BSS to set-up.

The element coding is:

**Table 11.3.82.a: PFCs to be set-up list IE**

	8	7	6	5	4	3	2	1
Octet 1	IEI							
Octet 2, 2a	Length Indicator							
Octet 3	Number of PFCs							
Octet 4-6	PFI (1)							
Octet 7-9	PFT (1)							
Octet 10-?	ABQP (1)							
Octet ?-?	Allocation/Retention Priority (1)							
Octet ?-?	T10 (1)							
Octet ?-?	PFI (2)							
Octet ?-?	PFT (2)							
Octet ?-?	ABQP (2)							
Octet ?-?	Allocation/Retention Priority (2)							
Octet ?-?	T10 (2)							
"	"							
Octet ?-?	PFI (n)							
Octet ?-?	PFT (n)							
Octet ?-?	ABQP (n)							
Octet ?-?	Allocation/Retention Priority (n)							
Octet ?-?	T10 (n)							

**Number of PFCs:** Number of PFCs for which packet flow context parameters are provided. For each of those PFCs follows its identifier and the packet flow context parameters. The "Number of PFCs" parameter is coded as shown below:

**Table 11.3.82.b: Number of PFCs**

Coding	Semantic
0000 0000	Reserved
0000 0001	1 PFC
...	...
0000 1011	11 PFCs
0000 1100	Reserved
'	"
1111 1111	Reserved

**PFI:** Packet Flow Identifier. Coded as the Packet Flow Identifier information element, see sub-clause 11.3.42

**PFT:** Packet Flow Timer. Coded as the GPRS Timer information element, see sub-clause 11.3.44.

**ABQP:** Aggregate BSS QoS Profile. Coded as the Aggregate BSS QoS Profile information element, see sub-clause 11.3.43.

**Allocation/Retention Priority:** Allocation Retention Priority. Coded as the Priority information element, see sub-clause 11.3.27. This information element is optionally included.

**T10:** T10. Coded as the GPRS Timer information element, see sub-clause 11.3.44. This information element shall be present for a PFC if the Allocation/Retention Priority is present and if queuing is allowed for the PFC.

### 11.3.83 List of set-up PFCs

This information element contains the Packet Flow Identifiers of the PFCs that were successfully allocated in the target system during a PS handover. The element coding is:

**Table 11.3.83.a: List of set-up PFCs IE**

	8	7	6	5	4	3	2	1
octet 1	IEI							
octet 2, 2a	Length Indicator							
octet 3	Number of PFCs							
Octet 4	PFI (1)							
Octet 5	PFI (2)							
"	"							
Octet ?	PFI (n)							

**Number of PFCs:** Number of PFCs for which corresponding Packet Flow Identifiers are provided. The "Number of PFCs" parameter is coded as shown below:

**Table 11.3.83.b: Number of PFCs**

Coding	Semantic
0000 0000	0 PFC
0000 0001	1 PFC
...	...
0000 1011	11 PFCs
0000 1100	Reserved
'	"
1111 1111	Reserved

**PFI:** Packet Flow Identifier. Coded as the value part of the Packet Flow Identifier information element in 3GPP TS 24.008, not including 3GPP TS 24.008 IEI.

## 11.3.84 Extended Feature Bitmap

The Extended Feature bitmap information element indicates the optional features supported by the underlying NSE. The element coding is:

**Table 11.3.84.a: Extended Feature Bitmap IE**

	8	7	6	5	4	3	2	1
octet 1	IEI							
octet 2, 2a	Length Indicator							
octet 3	Spare	Spare	Spare	EC-GSM-IoT	CS/PS coord	MOCN	Gigabit Interface	PS Handover

**Table 11.3.84.b: "PS Handover" coding**

coding	Semantic
0	PS Handover not supported
1	PS Handover supported

**Table 11.3.84.c: "Gigabit Interface" coding**

coding	Semantic
0	Gigabit Interface not supported
1	Gigabit Interface supported

**Table 11.3.84.d: "Multi Operator Core Network" coding**

coding	Semantic
0	Multi Operator Core Network not supported
1	Multi Operator Core Network supported

**Table 11.3.84.e: "CS/PS coordination enhancements" coding**

coding	Semantic
0	CS/PS coordination enhancements not supported
1 (note)	CS/PS coordination enhancements supported

**Table 11.3.84.f: "EC-EGPRS" coding**

coding	Semantic
0	EC-GSM-IoT not supported
1	EC-GSM-IoT supported

NOTE: The CS/PS coordination enhancements bit may only be set to "1" if the Multi Operator Core Network bit is set to "1".

### 11.3.85 Source to Target Transparent Container

This information element contains the information needed in the target RAN node to execute a inter-RAT PS or DTM Handover.

The element coding is:

**Table 11.3.85: Source to Target Transparent Container coding**

	8	7	6	5	4	3	2	1
Octet 1	IEI							
Octet 2, 2a	Length Indicator							
Octets 3-?	Source to Target Transparent Container content coded as specified in 3GPP TS 25.413 or 3GPP TS 36.413.							

In inter-RAT handovers to *Iu* mode this IE includes the Source RNC to Target RNC Transparent container. The Source RNC to Target RNC Transparent Container content structure and encoding is defined in relevant RANAP specification 3GPP TS 25.413, excluding RANAP tag.

In inter-RAT handover to E-UTRAN this IE includes the Source eNB to Target eNB Transparent container. The Source eNB to Target eNB Transparent Container content structure and encoding is defined in 3GPP TS 36.413.

### 11.3.86 Target to Source Transparent Container

This information element contains the information needed in the Source BSS to execute a inter-RAT PS Handover.

The element coding is:

**Table 11.3.86: Target to Source Transparent Container coding**

	8	7	6	5	4	3	2	1
Octet 1	IEI							
Octet 2, 2a	Length Indicator							
Octets 3-?	Rest of element coded as either a complete Handover to UTRAN Command radio interface message (as defined in 3GPP TS 25.331) or a complete Radio Bearer Reconfiguration radio interface message (as defined in 3GPP TS 44.118) or a HandoverCommand message that consists only of the <i>DL-DCCH-Message</i> including a complete <i>RRCCONNECTIONRECONFIGURATION</i> radio interface message (as defined in 3GPP TS 36.331)							

### 11.3.87 RNC Identifier

This information element contains the identifier of the RNC in case of PS Handover to UTRAN or the Corresponding RNC-ID of the eNB in case of PS handover to E-UTRAN as specified in 3GPP TS 25.413.

The element coding is:

**Table 11.3.87: RNC Identifier coding**

	8	7	6	5	4	3	2	1
Octet 1	IEI							
Octet 2, 2a	Length Indicator							
Octets 3-8	Octets 3 to 8 contain the value part (starting with octet 2) of the <i>Routing Area Identification</i> IE defined in 3GPP TS 24.008, not including 3GPP TS 24.008 IEI							
Octet 9	RNC ID (or Extended RNC-ID or Corresponding RNC-ID)							
Octet 10	RNC ID (or Extended RNC-ID or Corresponding RNC-ID) (continued)							



**RNC ID (or Extended RNC-ID or Corresponding RNC-ID):** The octets 9-10 contain the RNC-ID (0..4095) or the Corresponding RNC-ID (0..4095) or the Extended RNC-ID (4096..65535) - see 3GPP TS 25.413:

- The least significant bit of RNC-ID is octet 10 bit 1 and most significant bit is octet 9 bit 4. In the octet 9 bits 5-8 are set to "0000".
- The least significant bit of Extended RNC-ID is octet 10 bit 1 and most significant bit is octet 9 bit 8.

For detailed definition of the RNC-Id see 3GPP TS 23.003.

### 11.3.88 Page Mode

This information element contains the Page Mode to be used by the MS.

The element coding is:

**Table 11.3.88: Page Mode coding**

	8	7	6	5	4	3	2	1
Octet 1	IEI							
Octet 2, 2a	Length Indicator							
Octet 3	Reserved						PAGE_MODE coded as specified in 3GPP TS 44.060	

### 11.3.89 Container ID

This information element contains the identity of the neighbour cell system information container previously sent to the MS.

The element coding is:

**Table 11.3.89: Container ID coding**

	8	7	6	5	4	3	2	1
Octet 1	IEI							
Octet 2, 2a	Length Indicator							
Octet 3	Reserved						Container ID coded as specified in 3GPP TS 44.060	

### 11.3.90 Global TFI

This information element contains the TFI of the mobile station's downlink or uplink TBF.

The element coding is:

**Table 11.3.90: Global TFI coding**

	8	7	6	5	4	3	2	1
Octet 1	IEI							
Octet 2, 2a	Length Indicator							
Octet 3	Reserved	Global TFI coded as specified in 3GPP TS 44.060						

### 11.3.91 IMEI

This information element contains the International Mobile Station Equipment Identity (see 3GPP TS 23.003). The element coding is:

**Table 11.3.91: IMEI IE**

	8	7	6	5	4	3	2	1
octet 1	IEI							
octet 2, 2a	Length Indicator							
octet 3-10	Octets 3-10 contain the IMEI coded as the value part of the <i>Mobile Identity</i> IE defined in 3GPP TS 24.008 (NOTE 1)							
NOTE 1: The <i>Type of identity</i> field in the <i>Mobile Identity</i> IE shall be ignored by the receiver.								

### 11.3.92 Time to MBMS Data Transfer

The Time to MBMS Data Transfer denotes the time occurring between the transmission of the MBMS-SESSION-START-REQUEST PDU or the MBMS-SESSION-UPDATE-REQUEST PDU to the BSS and the actual start of the data transfer at the BM-SC.

**Table 11.3.92.a: Time to MBMS Data Transfer IE**

	8	7	6	5	4	3	2	1
Octet 1	IEI							
Octet 2, 2a	Length Indicator							
Octet 3	Time to MBMS Data Transfer Value Part							

**Table 11.3.92.b: Time to MBMS Data Transfer Value Part Coding**

Bits	
8 7 6 5 4 3 2 1	
0 0 0 0 0 0 0 0	1s
0 0 0 0 0 0 0 1	2s
0 0 0 0 0 0 1 0	3s
:	
1 1 1 1 1 1 1 1	256s

### 11.3.93 MBMS Session Repetition Number

The MBMS Session Repetition Number denotes the repetition number of the MBMS session as defined in 3GPP TS 23.246 [32]. The element coding is:

**Table 11.3.93: MBMS Session Repetition Number IE**

	8	7	6	5	4	3	2	1
Octet 1	IEI							
Octet 2, 2a	Length Indicator							
Octet 3	MBMS-Session-Repetition-Number AVP encoded as in 3GPP TS 29.061 [31], excluding AVP Header fields as defined in IETF RFC 3588 [33].							

### 11.3.94 Inter RAT Handover Info

This information element contains UTRAN related information needed to be transferred to the target RNC during a PS Handover to UTRAN. The element coding is:

**Table 11.3.94: Inter RAT Handover Information coding**

	8	7	6	5	4	3	2	1
Octet 1	IEI							
Octet 2, 2a	Length Indicator							
Octets 3-?	Inter RAT Handover Information coded as specified in 3GPP Technical Specification 25.331							

### 11.3.95 PS Handover Command

This information element contains the radio interface message to be sent to the mobile station.

The element coding is:

**Table 11.3.95: PS Handover Command coding**

	8	7	6	5	4	3	2	1
Octet 1	IEI							
Octet 2 2a	Length Indicator							
Octet 3-?	Rest of element coded as a complete PS Handover Command radio interface message as defined in 3GPP TS 44.060 (carrying the <i>PS Handover to A/Gb Mode Payload</i> )							

### 11.3.95a PS Handover Indications

The *PS Handover Indications* information element provides indications related to the PS Handover procedure. The element coding is:

**Table 11.3.95a.a: PS Handover Indications IE**

	8	7	6	5	4	3	2	1	
octet 1	IEI								
octet 2, 2a	Length Indicator								
octet 3	Spare					DMLC Carriers		SI/PSI	

**Table 11.3.95a.b: "SI/PSI" coding**

coding	Semantic
0	SI/PSI not requested
1	SI/PSI requested

**Table 11.3.95a.c: "DLMC Carriers" coding**

coding	Semantic
00	2 or 3 carriers currently assigned
01	4 or 5 carriers currently assigned
10	6 or 7 carriers currently assigned
11	8 or more carriers currently assigned

## 11.3.95b SI/PSI Container

The *SI/PSI Container* information element provides the (Packet) System Information messages of the GSM target cell that are required by the mobile station for PS Handover. The element coding is:

**Table 11.3.95b.a: SI/PSI Container coding**

	8	7	6	5	4	3	2	1
Octet 1	IEI							
Octet 2, 2a	Length Indicator							
Octet 3	Number of SI/PSI							Type
Octet 4-n	SI/PSI							

**Type:** This field indicates the type of the (Packet) System Information messages provided by the target cell. The *Type* field is coded as shown below:

**Table 11.3.95b.b: Type coding**

Coding	Semantic
0	SI messages as specified for BCCH (3GPP TS 44.018) follow
1	PSI messages as specified for PBCCH (3GPP TS 44.060) follow

**Number of SI/PSI:** This field indicates the number of (Packet) System Information messages contained in the *SI/PSI field*. For (Packet) System Information messages with multiple instances, each instance is counted as one SI/PSI message. The *Number of SI/PSI* field is coded as shown below:

**Table 11.3.95b.c: Number of SI/PSI coding**

Coding	Semantic
000 0000	0 "SI/PSI" follows
000 0001	1 "SI/PSI" follow
'	"
111 1111	127 "SI/PSI" follow

**SI/PSI:** This field contains either a list of System Information or a list of Packet System Information messages of the GSM target cell that are required by the mobile station for PS Handover as specified in 3GPP TS 44.060. The number of (Packet) System Information messages is indicated in the *Number of SI/PSI* field specified above. Furthermore:

- If the *Type* field indicates that "SI messages as specified for BCCH (3GPP TS 44.018) follow" then the *SI/PSI* field contains the subset of System Information message instances encoded for BCCH as specified in 3GPP TS 44.018. Each System Information message contains the *Message type* octet followed by all the IEs composing the message payload. Each message is 21 octets long.
- If the *Type* field indicates that "PSI messages as specified for PBCCH (3GPP TS 44.060) follow" then the *SI/PSI* field contains the subset of Packet System Information message instances encoded for PBCCH as specified in 3GPP TS 44.060. Each Packet System Information message contains the *MESSAGE\_TYPE* field followed by the PSI message content. Each message is 22 octets long.

### 11.3.95c Active PFCs List

This information element contains the Packet Flow Identifiers of the PFCs that are active in the source BSS at the time the PS Handover Required message is sent. The element coding is:

**Table 11.3.95c.a: Active PFCs List IE**

	8	7	6	5	4	3	2	1
octet 1	IEI							
octet 2, 2a	Length Indicator							
octet 3	Number of PFCs							
Octet 4	PFI (1)							
Octet 5	PFI (2)							
"	"							
Octet ?	PFI (n)							

**Number of PFCs:** Number of PFCs for which corresponding Packet Flow Identifiers are provided. The "Number of PFCs" parameter is coded as shown below:

**Table 11.3.95c.b: Number of PFCs**

Coding	Semantic
0000 0000	Reserved
0000 0001	1 PFC
...	...
0000 1011	11 PFCs
0000 1100	Reserved
'	"
1111 1111	Reserved

**PFI:** Packet Flow Identifier. Coded as the value part of the Packet Flow Identifier information element in 3GPP TS 24.008, not including 3GPP TS 24.008 IEI. This IE shall not contain any pre-defined PFIs.

### 11.3.96 Velocity Data

This is a variable length information element providing an estimate of a velocity data. The element coding is:

**Table 11.3.96: Velocity Data IE**

	8	7	6	5	4	3	2	1
Octet 1	IEI							
Octet 2	Length indicator							
Octet 3 to Octet n	The rest of the information element contains an octet sequence identical to that for Description of Velocity defined in 3GPP TS 23.032.							

### 11.3.97 DTM Handover Command

This information element contains the radio interface message to be sent to the mobile station.

The element coding is:

**Table 11.3.97: DTM Handover Command coding**

	8	7	6	5	4	3	2	1
Octet 1	IEI							
Octet 2, 2a	Length Indicator							
Octet 3-?	Rest of element coded as a complete DTM Handover Command radio interface message as defined in 3GPP TS 44.060 (carrying the <i>DTM Handover to A/Gb Mode Payload</i> )							

### 11.3.98 CS Indication

This information element indicates to the target BSS that this PS Handover is part of a DTM Handover Procedure.

The element coding is:

**Table 11.3.98: CS Indication coding**

	8	7	6	5	4	3	2	1
Octet 1	IEI							
Octet 2, 2a	Length Indicator							
Octet 3	CS Indication Contents							

**CS Indication Contents:** This identifies a particular handover attempt for this MS. This shall be identical to the *PS Indication Contents* value in the corresponding *PS Indication IE* included in the *Old BSS to New BSS Information IE* (see 3GPP TS 48.008). The choice of the value of this field is implementation specific, with the requirement that consecutive handover attempts for the same mobile station shall not have the same *CS Indication Contents* value.

### 11.3.99 Requested GANSS Assistance Data

This information element provides the information on which GANSS Assistance Data has been requested. The element coding is:

**Table 11.3.99: Requested GANSS Assistance Data IE**

	8	7	6	5	4	3	2	1
octet 1	IEI							
octet 2, 2a	Length Indicator							
octet 3-n	Rest of element coded as the value part defined in 3GPP TS 49.031, not including 3GPP TS 49.031 IEI and 3GPP TS 49.031 octet length indicator							

### 11.3.100 GANSS Location Type

This information element provides the GANSS Location Type. The element coding is:

**Table 11.3.53: Location Type IE**

	8	7	6	5	4	3	2	1
octet 1	IEI							
octet 2, 2a	Length Indicator							
octet 3	Rest of element coded as the value part defined in 3GPP TS 49.031, not including 3GPP TS 49.031 IEI and 3GPP TS 49.031 octet length indicator							

### 11.3.101 GANSS Positioning Data

This information element provides GANSS Positioning Data. The element coding is:

**Table 11.3.55: Positioning Data IE**

	8	7	6	5	4	3	2	1
octet 1	IEI							
octet 2, 2a	Length Indicator							
octet 3-n	Rest of element coded as the value part defined in 3GPP TS 49.031, not including 3GPP TS 49.031 IEI and 3GPP TS 49.031 octet length indicator							

### 11.3.102 Flow Control Granularity

This information element provides the granularity to be used for deriving the Flow Control parameters values in the *BVC Bucket Size* IE, the *BVC Bucket Leak Rate* IE and the *PFC flow control parameters* IE when the Gigabit Interface feature is negotiated. The element coding is:

**Table 11.3.102: Flow Control Granularity IE**

	8	7	6	5	4	3	2	1
octet 1	IEI							
octet 2, 2a	Length Indicator							
octet 3	Reserved						Granularity	

**Table 11.3.102.a: "Granularity" coding**

coding	Semantic
00	100 octets or bits/s increments
01	1000 octets or bits/s increments
10	10000 octets or bits/s increments
11	100000 octets or bits/s increments

### 11.3.103 eNB Identifier

This information element contains the information required to identify an eNB within a PLMN.

The element coding is:

**Table 11.3.103: eNB Identifier coding**

	8	7	6	5	4	3	2	1
Octet 1	IEI							
Octet 2, 2a	Length Indicator							
Octets 3-7	Octets 3 to 7 contain the value part (starting with octet 2) of the <i>Tracking Area Identity</i> IE defined in 3GPP TS 24.301 [37], not including 3GPP TS 24.301 IEI [37]							
Octet 8-n	Global eNB ID							

Octets 8-n contain the Global eNB ID (see 3GPP TS 36.413 [36] sub-clause 9.3.4, *Global-eNB-ID* Sequence) of the eNodeB.

### 11.3.104 E-UTRAN Inter RAT Handover Info

This information element contains E-UTRAN related information needed to be transferred to the target eNB during a PS Handover to E-UTRAN. The element coding is:

**Table 11.3.104: E-UTRAN Inter RAT Handover Information coding**

	8	7	6	5	4	3	2	1
Octet 1	IEI							
Octet 2, 2a	Length Indicator							
Octets 3-?	Formatted and coded according to the <i>UE-EUTRA-Capability</i> IE defined in 3GPP Technical Specification 36.331. The most significant bit of the first octet of the octet string contains bit 8 of the first octet of the IE.							

### 11.3.105 Subscriber Profile ID for RAT/Frequency priority

This information element may be used by the BSS to provide individual priorities (see 3GPP TS 44.060) to mobile stations.

The element coding is:

**Table 11.3.105.1: Subscriber Profile ID for RAT/Frequency priority coding**

	8	7	6	5	4	3	2	1
Octet 1	IEI							
Octet 2	Length Indicator							
Octet 3	Octet 3 contains the value part of the Subscriber Profile ID for RAT/Frequency priority IE.							

Octet 3 contains a number in binary representation ranging from 0 to 255. The Subscriber Profile ID for RAT/Frequency priority is given by the indicated value +1.

### 11.3.106 Request for Inter-RAT Handover Info

The *Request for Inter RAT Handover Info* information element provides the request from the BSS to the SGSN for the *Inter RAT Handover Info* IE for UTRAN necessary for inter-RAT PS Handover procedure to UTRAN. The element coding is:

**Table 11.3.106.a: Request for Inter RAT Handover Info IE**

	8	7	6	5	4	3	2	1
octet 1	IEI							
octet 2, 2a	Length Indicator							
octet 3	Spare						E-UTRAN Inter RAT Handover Info Req	Inter RAT Handover Info Req

**Table 11.3.106.b: "Inter RAT Handover Info Req" coding**

Coding	Semantic
0	Inter RAT Handover Info not requested
1	Inter RAT Handover Info requested

**Table 11.3.106.c: "E-UTRAN Inter RAT Handover Info Req" coding**

coding	Semantic
--------	----------



0	See note
NOTE: The value '1' was allocated in a previous version of the protocol and shall not be used.	

### 11.3.107 Reliable Inter-RAT Handover Info

The *Reliable Inter RAT Handover Info* information element provides to the target BSS the indication that the source BSS has received the *Inter RAT Handover Info* for UTRAN from the SGSN in the CREATE-BSS-PFC-PDU or in the PS-HANDOVER-COMplete-ACK PDU upon successful completion of PS handover or a PS-HANDOVER-REQUEST PDU with '*Reliable Inter RAT Handover Info Indicator*' set to '1'. The element coding is:

**Table 11.3.107.a: Reliable Inter RAT Handover Info IE**

	<b>8</b>	<b>7</b>	<b>6</b>	<b>5</b>	<b>4</b>	<b>3</b>	<b>2</b>	<b>1</b>
octet 1	IEI							
octet 2, 2a	Length Indicator							
octet 3	Spare							Reliable Inter RAT Handover Info Indicator

**Table 11.3.107.b: 'Reliable Inter RAT Handover Info Indicator' coding**

Coding	Semantic
0	Inter RAT Handover Info not reliable
1	Inter RAT Handover Info reliable

### 11.3.108 SON Transfer Application Identity

This information element specifies the addressed SON Transfer application within the target BSS node. The element coding is:

**Table 11.3.108: SON Transfer Application Identity IE**

	<b>8</b>	<b>7</b>	<b>6</b>	<b>5</b>	<b>4</b>	<b>3</b>	<b>2</b>	<b>1</b>
Octet 1	IEI							
Octet 2, 2a	Length Indicator							
Octet 3-m	SON Transfer Application Identity							

**SON Transfer Application Identity:** This field is encoded as the *SON Transfer Application Identity* IE as defined in 3GPP TS 36.413 [36].

### 11.3.109 CSG Identifier

The *CSG Identifier* information element indicates the identifier of the Closed Subscriber Group within the PLMN, as defined in [40], and the cell access mode of the CSG cell as defined in [22], [39]. The element coding is:

**Table 11.3.109.a: CSG Identifier IE**

<b>8</b>	<b>7</b>	<b>6</b>	<b>5</b>	<b>4</b>	<b>3</b>	<b>2</b>	<b>1</b>
----------	----------	----------	----------	----------	----------	----------	----------

octet 1	IEI	
octet 2, 2a	Length Indicator	
octets 3-6	Octets 3 to 6 contain the <i>CSG Identity (CSG-ID)</i> of the cell (defined in 3GPP TS 23.003) as reported by the mobile station (see 3GPP TS 44.060). Bits 4 to 8 of octet 6 are spare and set to zero.	
octet 7	Spare	Cell Access Mode

**Table 11.3.109.b: Cell Access Mode field element details**

<p><b>Cell Access Mode</b> (bit 1 of octet 7)                  This field indicates the cell access mode of the cell as reported by the mobile station.                  Bit  <b>1</b>                  0 CSG cell                  1 Hybrid cell</p>
---

Spare bits are reserved and coded with zeroes.

### 11.3.110 Tracking Area Code

The TAC information element provides an unambiguous identification of tracking areas needed for routing of the PS handover signalling to the target cell. The element coding is:

**Table 11.3.110: TAC IE**

	8	7	6	5	4	3	2	1
octet 1	IEI							
octet 2, 2a	Length Indicator							
octets 3-5	Octets 3 to 5 contain the value part (starting with octet 2) of the TAC <i>IE</i> defined in 3GPP TS 24.301.							

### 11.3.111 Redirect Attempt Flag

This information element provides control information for the MOCN and for the GWCN rerouting procedure. It indicates that the CN shall include in the answer either Redirection Indication IE or Redirection Completed IE.

The element coding is:

**Table 11.3.111: Redirect Attempt Flag IE**

	8	7	6	5	4	3	2	1
Octet 1	IEI							
Octet 2, 2a	Length Indicator							
Octet 3	spare							

### 11.3.112 Redirection Indication

This information element provides control information for the MOCN and for the GWCN rerouting procedure. It indicates that the CN requests rerouting by the BSS to another CN operator. The Reroute Reject cause is given.

**Table 11.3.112: Redirection Indication IE**

	8	7	6	5	4	3	2	1
--	---	---	---	---	---	---	---	---

Octet 1	IEI
Octet 2, 2a	Length Indicator
Octet 3	Reroute Reject Cause value

Reroute Reject cause value (octet 3)								
Bits								
8	7	6	5	4	3	2	1	
0	0	0	0	0	0	0	0	Reserved
0	0	0	0	1	0	1	0	Reserved
0	0	0	0	1	0	1	1	PLMN not allowed (meaning is defined in 3GPP TS 24.008 [11])
0	0	0	0	1	1	0	0	location area not allowed (meaning is defined in 3GPP TS 24.008 [11])
0	0	0	0	1	1	0	1	roaming not allowed in this location area (meaning is defined in 3GPP TS 24.008 [11])
0	0	0	0	1	1	1	0	GPRS services not allowed in this PLMN (meaning is defined in 3GPP TS 24.008 [11])
0	0	0	0	1	1	1	1	no suitable cell in location area (meaning is defined in 3GPP TS 24.008 [11])
0	0	0	1	0	0	0	0	CS/PS domain registration coordination required (meaning defined in 3GPP TS 23.251 [43])
0	0	0	1	0	0	0	1	Network failure (meaning is defined in 3GPP TS 24.008 [11])
0	0	0	1	0	0	1	0	Reserved
1	1	1	1	1	1	1	1	Reserved

### 11.3.113 Redirection Completed

This information element provides control information for the MOCN and for the GWCN rerouting procedure. It indicates that the reroute procedure is completed.

The element coding is:

**Table 11.3.113: Redirection Completed IE**

	8	7	6	5	4	3	2	1
Octet 1	IEI							
Octet 2, 2a	Length Indicator							
Octet 3	Outcome value							

Outcome value (octet 3)								
Bits								
8	7	6	5	4	3	2	1	
0	0	0	0	0	0	0	0	Reserved
0	0	0	0	0	0	0	1	MS is accepted
0	0	0	0	0	0	1	0	MS is not accepted
0	0	0	0	0	0	1	1	MS is already registered
0	0	0	0	0	1	0	0	Reserved
1	1	1	1	1	1	1	1	Reserved

### 11.3.114 Unconfirmed send state variable

This IE indicates the value of the Unconfirmed send state variable as defined in 3GPP TS 44.064 [12].

The element coding is:

**Table 11.3.114: Unconfirmed send state variable IE**

	8	7	6	5	4	3	2	1	
Octet 1	IEI								
Octet 2, 2a	Length Indicator								
Octet 3	spare							V(U)	MSB
Octet 4	V(U)								

Octet 2 and bit 1 of octet 3 contain a number in binary representation ranging from 0 to 511. The least significant bit is bit 1 of octet 3, and the most significant bit is bit 1 of octet 2.

### 11.3.115 IRAT Measurement Configuration

The *IRAT Measurement Configuration* IE is used to indicate to the BSS which frequency measurement results of the source RAT shall be collected after a successful inter-system handover. The *IRAT Measurement Configuration* IE is used by the source RAT to specify the E-UTRA frequencies for which the corresponding EARFCN is less than 65535 to be reported back to the source RAT (each of them associated with a measurement bandwidth), the minimum radio quality and the period of time that the measurements should last before triggering a *HO Report* for unnecessary handover to another RAT.

NOTE 1: *HO Report* is defined in 3GPP TS 36.413 [36].

NOTE 2: The functionality of Unnecessary IRAT HO is described in 3GPP TS 36.300 [45].

NOTE 3: E-UTRA frequencies corresponding to E-ARFCNs in the value range from 65536 to 262143 shall be indicated using the *IRAT Measurement Configuration (extended E-ARFCNs)* IE (see subclause 11.3.121); in such a case, E-UTRA frequencies corresponding to E-ARFCNs in the value range from 0 to 65534 (value 65535 is reserved and shall not be used) shall be indicated using the *IRAT Measurement Configuration* IE.

The element coding is:

**Table 11.3.115: IRAT Measurement Configuration IE**

	8	7	6	5	4	3	2	1
Octet 1	IEI							
Octet 2	Length Indicator							
Octet 3	Spare	REP_Q UANT	REPORTING_THRESHOLD					
Octet 4	Measurement_Duration							
Octets 5-6	E-ARFCN							
Octet 7	Spare					Measurement Bandwidth		
Octets 8-9	E-ARFCN							
Octet 10	Spare					Measurement Bandwidth		
Octets m- (m+1)	E-ARFCN							
Octet m+2	Spare					Measurement Bandwidth		

**REPORTING\_THRESHOLD:** defines the reporting threshold to be used for measurement results analysis according to REP\_QUANT. This threshold is used to compare against the measurement results received from the MS. It is a value between 0 and 63 encoded on 6 bits according to 3GPP TS 45.008 [44] sub-section 8.1.5.4.

**REP\_QUANT:** indicates the measurement quantity for E-UTRAN cells coded as follows: 0=RSRP 1=RSRQ.

**Measurement\_Duration:** defines (in seconds) how long the BSS shall collect the measurements results received from the MS after a successful inter-RAT handover. It is a number in binary representation ranging from 1 to 100.

**E-ARFCN:** designates a specific E-UTRA frequency for which the target RAT should continue to collect the measurement results received from MS of this frequency. It is coded as a number in binary representation ranging from 0 to 65534 (value 65535 is reserved and shall not be used).

**Measurement Bandwidth:** defines the measurement bandwidth of the E-UTRA frequency signalled in the two previous octets. It is coded on 3 bits according to 3GPP TS 44.018 [25].

### 11.3.116 SCI

The SCI information element provides information on the service class of the user data. The element coding is:

**Table 11.3.116-1: SCI IE**

	<b>8</b>	<b>7</b>	<b>6</b>	<b>5</b>	<b>4</b>	<b>3</b>	<b>2</b>	<b>1</b>
octet 1	IEI							
octet 2, 2a	Length Indicator							
octet 3	Octet 3 contains the value part (octet 2) of the SCI IE defined in 3GPP TS 29.281 [46].							

Octet 3 specifies the Service Class value for LLC PDUs of applications benefitting from specific RRM behaviour.

### 11.3.117 GGSN/P-GW location

The GGSN/P-GW location information element provides information on the location of the GGSN/P-GW that encoded the SCI. The element coding is:

**Table 11.3.117.a: GGSN/P-GW location IE**

	<b>8</b>	<b>7</b>	<b>6</b>	<b>5</b>	<b>4</b>	<b>3</b>	<b>2</b>	<b>1</b>
octet 1	IEI							
octet 2, 2a	Length Indicator							
octet 3	GGSN/P-GW location							

In octet 3, bits 8 to 4 are spare, set to zero by the SGSN and shall be ignored by the BSS. The coding of bits 3 to 1 is specified in Table 11.3.117.b.

**Table 11.3.117.b: GGSN/P-GW location coding**

Octet 3 Bit: 3 2 1	Semantic
0 0 0	HPLMN
0 0 1	VPLMN
0 1 0	Operator Group GGSN
0 1 1	Unknown
1 0 0 to 1 1 1	For future use (treat as VPLMN)

The conditions under which the SGSN indicates the values defined in Table 11.3.117.b are specified in 3GPP TS 23.060 [7].

### 11.3.118 Selected PLMN ID

The purpose of the *Selected PLMN ID* information element is to provide the SGSN with the PLMN ID selected by a mobile station supporting network sharing when network sharing is in use in a cell.

**Table 11.3.116: Selected PLMN ID IE**

	8	7	6	5	4	3	2	1
octet 1	IEI							
octet 2, 2a	Length Indicator							
Octet 3	MCC dig 2				MCC dig 1			
Octet 4	MNC dig 3				MCC dig 3			
Octet 5	MNC dig 2				MNC dig 1			

NOTE: The MCC and MNC value field is coded as specified within 3GPP TS 24.008 [11].

### 11.3.119 Priority Class Indicator

This information element indicates that overload has occurred in the SGSN and traffic for the indicated priority class should be reduced.

**Table 11.3.118: Priority Class Indicator IE**

	8	7	6	5	4	3	2	1
octet 1	IEI							
octet 2	Length Indicator							
octet 3	Value part of Priority Class Indicator							

The *Value part of Priority Class Indicator* is coded as a bit string with length of 8. Each bit represents a kind of priority class as specified below. If a bit is set to '1', the signalling traffic of the respective priority class should be reduced.

Bit (0) = A mobile station configured for "low access priority" as defined in TS 44.060.

Bits (1...7) are spare. The SGSN shall set them to "0". The BSS shall ignore them.

### 11.3.120 Source Cell ID IE

The *Source Cell ID IE* is used to indicate to the BSS the identification of the source cell, e.g. in the Unnecessary IRAT HO case (see *IRAT Measurement Configuration IE* description, subclause 11.3.115).

The element coding is:

**Table 11.3.120: Source Cell ID IE**

	8	7	6	5	4	3	2	1
Octet 1	IEI							
Octet 2	Length Indicator							
Octet 3-7	Tracking Area Identity							
Octet 8-m	E-UTRAN CGI							
Octet(m+1)-n	Global eNB ID							

**Tracking Area Identity:** Octets 3 to 7 contain the value part of the *Tracking Area Identity IE* defined in 3GPP TS 24.301, not including 3GPP TS 24.301 IEI.

**E-UTRAN CGI:** Octets 8 - m contain the E-UTRAN CGI (see 3GPP TS 36.413 sub-clause 9.3.4, *EUTRAN-CGI Sequence*) for the source cell.

**Global eNB ID:** Octets (m+1)-n contain the Global eNB ID (see 3GPP TS 36.413 sub-clause 9.3.4, *Global-eNB-ID Sequence*) for the source eNB.

### 11.3.121 IRAT Measurement Configuration (extended E-ARFCNs)

The *IRAT Measurement Configuration (extended E-ARFCNs)* IE is used to indicate to the BSS which frequency measurement results of the source RAT shall be collected after a successful inter-system handover. The *IRAT Measurement Configuration* IE is used by the source RAT to specify the E-UTRA frequencies for which the corresponding E-ARFCN is greater than 65535 to be reported back to the source RAT (each of them associated with a measurement bandwidth), the minimum radio quality and the period of time that the measurements should last before triggering a *HO Report* for unnecessary handover to another RAT.

NOTE 1: *HO Report* is defined in 3GPP TS 36.413 [36].

NOTE 2: The functionality of Unnecessary IRAT HO is described in 3GPP TS 36.300 [45].

The element coding is:

**Table 11.3.121: IRAT Measurement Configuration (extended E-ARFCN) IE**

	8	7	6	5	4	3	2	1
Octet 1	IEI							
Octet 2	Length Indicator							
Octet 3	Spare	REP_Q UANT	REPORTING_THRESHOLD					
Octet 4	Measurement_Duration							
Octets 5-6	E-ARFCN							
Octet 7	E-ARFCN		Spare			Measurement Bandwidth		
Octets 8-9	E-ARFCN							
Octet 10	E-ARFCN		Spare			Measurement Bandwidth		
Octets m- (m+1)	E-ARFCN							
Octet m+2	E-ARFCN		Spare			Measurement Bandwidth		

**REPORTING\_THRESHOLD:** see subclause 11.3.115.

**REP\_QUANT:** see subclause 11.3.115.

**Measurement\_Duration:** see subclause 11.3.115.

**E-ARFCN:** designates a specific E-UTRA frequency for which the target RAT should continue to collect the measurement results received from MS of this frequency. It is coded as a number in binary representation ranging from 65536 to 262143 in which bit 8 octet m is the most significant bit while bit 7 octet (m+2) is the least significant bit.

**Measurement Bandwidth:** see subclause 11.3.115.

### 11.3.122 eDRX Parameters

This information element is used to indicate the eDRX cycle value the BSS is to use for determining the reachability of a MS that has enabled eDRX operation. The element coding is:

**Table 11.3.122: eDRX Parameters IE**

	8	7	6	5	4	3	2	1
octet 1	IEI							
octet 2, 2a	Length Indicator							
octet 3	Spare				eDRX Cycle Value			

The BSS uses the eDRX cycle value indicated by the eDRX Parameters IE along with the IMSI to determine the nominal paging group of a mobile station (see 3GPP TS 45.002 [48]). The eDRX cycle value is coded as specified within 3GPP TS 24.008 [11]).

### 11.3.123 Time Until Next Paging Occasion

This information element is used to indicate the time until the next paging occasion for a MS for which the BSS has rejected a PS-PAGING PDU received from the SGSN. The element coding is:

The BSS uses information provided by the PAGING-PS PDU to calculate the time until the next paging occasion in minutes and seconds and includes it within this IE.

The 'Minutes' field is coded as shown below.

**Table 11.3.123: Time Until Next Paging Occasion IE**

	8	7	6	5	4	3	2	1
octet 1	IEI							
octet 2, 2a	Length Indicator							
octet 3	Spare			Minutes				
octet 4	Spare			Seconds				

The 'Seconds' field is coded as shown below.

**Table 11.3.123.b: "Seconds" coding**

<b>coding</b>	<b>semantic</b>
0000 0000	0 seconds
0000 0001	1 second
0000 0010	2 seconds
0000 0011	3 seconds
....	
0011 1011	59 seconds
All other values are reserved.	



### 11.3.124 Coverage Class

This information element is used to indicate the uplink and downlink Coverage Class associated with a given MS supporting EC operation. The element coding is:

**Table 11.3.124.a: Coverage Class IE**

	8	7	6	5	4	3	2	1
octet 1	IEI							
octet 2, 2a	Length Indicator							
octet 3	spare		DL Coverage Class			UL Coverage Class		

**UL Coverage Class:** Octet 3, bits 1 to 3, contain the value part of the uplink Coverage Class.

**DL Coverage Class:** Octet 3, bits 4 to 6, contain the value part of the downlink Coverage Class.

The UL Coverage Class field is coded as shown below:

**Table 11.3.124.b: UL Coverage Class field**

Coding	Semantic
000	reserved
001	UL Coverage Class 1
010	UL Coverage Class 2
011	UL Coverage Class 3
100	UL Coverage Class 4
All other values are reserved.	

The DL Coverage Class field is coded as shown below:

**Table 11.3.124.c: DL Coverage Class field**

Coding	Semantic
000	reserved
001	DL Coverage Class 1
010	DL Coverage Class 2
011	DL Coverage Class 3
100	DL Coverage Class 4
All other values are reserved.	

Spare bits are reserved and coded with zeroes.

### 11.3.125 Paging Attempt Information

This information element provides the BSS with paging attempt count and intended number of paging attempts information for a given paging procedure for an MS.

The element coding is:

**Table 11.3.125.a: Paging Attempt Information IE**

	8	7	6	5	4	3	2	1
octet 1	IEI							
octet 2, 2a	Length Indicator							
octet 3	Intended Number of Paging Attempts					Paging Attempt Count		

The Paging Attempt Count field is coded as shown below:

**Table 11.3.125.b: Paging Attempt Count field**

Coding	Semantic
000	1 <sup>st</sup> paging attempt
001	2 <sup>nd</sup> paging attempt
010	3 <sup>rd</sup> paging attempt
011	4 <sup>th</sup> paging attempt
100	5 <sup>th</sup> paging attempt
101	6 <sup>th</sup> paging attempt
110	7 <sup>th</sup> paging attempt
111	8 <sup>th</sup> paging attempt

The Intended Number of Paging Attempts field is coded as shown below:

**Table 11.3.125.c: Intended Number of Paging Attempts field**

Coding	Semantic
0000	Information not available
0001	1 page attempt
0010	2 page attempts
0011	3 page attempts
0100	4 page attempts
0101	5 page attempts
0110	6 page attempts
0111	7 page attempts
1000	8 page attempts
All other values are reserved	

### 11.3.126 Exception Report Flag

This information element is included if the LLC PDU carried within the UL-UNITDATA PDU was sent by the MS using an uplink EC TBF established in response to an EC PACKET CHANNEL REQUEST message or an EC PACKET DOWNLINK ACK/NACK message including a channel request, indicating high priority (i.e. an exception report), see 3GPP TS 44.018 [25] and 3GPP TS 44.060 [22].

The element coding is:

**Table 11.3.126a: Exception Report Flag IE**

	8	7	6	5	4	3	2	1
octet 1	IEI							
octet 2, 2a	Length Indicator							
octet 3	Spare							

### 11.3.127 Old Routing Area Identification

This information element provides the BSS with the Old Routing Area Identification (RAI) as reported by the MS in the initial Layer 3 message. It is used in MOCN and GWCN configurations for network sharing.

The element coding is:

**Table 11.3.127: Old Routing Area Identification IE**

	8	7	6	5	4	3	2	1
octet 1	IEI							
octet 2, 2a	Length Indicator							
octets 3-8	Octets 3 to 8 contain the value part (starting with octet 2) of the Routing Area Identification IE defined in 3GPP TS 24.008, not including 3GPP TS 24.008 IEI							

### 11.3.128 Attach Indicator

This information element provides the BSS with the information of an ongoing GPRS attach for a given mobile station. It is used in MOCN and GWCN configurations for network sharing.

The element coding is:

**Table 11.3.128: Attach Indicator IE**

	8	7	6	5	4	3	2	1
octet 1	IEI							
octet 2, 2a	Length Indicator							
octet 3	spare							

### 11.3.129 PLMN Identity

The purpose of the *PLMN Identity* information element is to identify a given CN operator. It is used in MOCN and GWCN configurations for network sharing.

The element coding is:

**Table 11.3.129: PLMN Identity IE**

	8	7	6	5	4	3	2	1
octet 1	IEI							
octet 2, 2a	Length Indicator							
octet 3	MCC dig 2				MCC dig 1			
octet 4	MNC dig 3				MCC dig 3			
octet 5	MNC dig 2				MNC dig 1			

The MCC and MNC value fields are coded as specified within 3GPP TS 24.008 [11].

### 11.3.130 MME Query

This information element provides control information for the MS Registration Enquiry procedure. The purpose of the *MME Query* IE is to request the SGSN to send a registration information enquiry to each MME that may hold the context for a given MS. It is used in MOCN and GWCN configurations for network sharing.

The element coding is:

**Table 11.3.130: MME Query IE**

	8	7	6	5	4	3	2	1
octet 1	IEI							
octet 2, 2a	Length Indicator							
octet 3	spare							

## 12 List of system variables

### 12.1 General Variables

**Table 12.1.a: Procedure timers**

Timer mnemonic	Value range	Notes	Relation to other timers
T1	1 s < T1 < 30 s	Guards the (un)blocking procedures	none
T2	1 s < T2 < 120 s	Guards the reset procedure	none
T3	0,1 s < T3 < 10 s	Guards the suspend procedure	none
T4	0.1 s < T4 < 10 s	Guards the resume procedure	none
T5	1 s < T5 < 30 s	Guards the Radio Access Capability Update procedure	none
T6	0,1 s < T6 < 10 s	Guards the DOWNLOAD-BSS-PFC PDU	none
T7	0,1 s < T7 < 10 s	Guards the CREATE-BSS-PFC PDU	none
T8	0,1 s < T8 < 10 s	Guards the MODIFY-BSS-PFC PDU	none
T9	Same as T3314 READY timer in 3GPP TS 24.008. Minimum 6 s	This is the Packet Flow Timer (PFT) and holds the maximum time the BSS may store a BSS PFC while no uplink data is transmitted	Cannot exceed the value of the READY timer for this MS unless READY timer is less than 6 s.
T10	0,5 s ≤ T10 < 10 s	Guards the PFC queuing procedure	T10 < T7
T11	0,1 s < T11 < 10 s	Guards the MBMS Session Start, MBMS Session Update and MBMS Session Stop procedures	none
T12	0,5 s ≤ T12 < 10 s	Guards the PS Handover Required procedure in the BSS	none
T13	0,5 s ≤ T13 < 10 s	Guards the PS Handover Request procedure in the SGSN	none
T14	0,5 s ≤ T14 < 10 s	Guards the PS Handover Complete procedure in the SGSN	none
T15	O&M	Overload timer in BSS, see sub-clause 8.6.1	T15 < T16
T16	O&M	Overload timer in BSS, see sub-clause 8.6.1	none

**Table 12.1.b: Procedure retry counters**

Retry mnemonic	Retry value	Notes
BVC-BLOCK-RETRIES	3	none
BVC-UNBLOCK-RETRIES	3	none
BVC-RESET-RETRIES	3	none
SUSPEND-RETRIES	3	none
RESUME-RETRIES	3	none
RA-CAPABILITY-UPDATE-RETRIES	3	none
DOWNLOAD-BSS-PFC-RETRIES	3	none
CREATE-BSS-PFC-RETRIES	3	none
MODIFY-BSS-PFC-RETRIES	3	none
MBMS-SESSION-START-REQUEST-RETRIES	3	none
MBMS-SESSION-STOP-REQUEST-RETRIES	3	none
MBMS-SESSION-UPDATE-REQUEST-RETRIES	3	none

### 12.2 Flow control variables

**Table 12.2: Flow control variables**

Variable mnemonic	Value range	Notes	Relation to other variables
-------------------	-------------	-------	-----------------------------

Th	$5 \text{ s} < \text{Th} < 6\,000 \text{ s}$	Interval after Flow-Control-MS before SGSN may use SGSN generated Bmax and R	none
C	$1 \text{ s} < \text{C} < 10 \text{ s}$	Minimum interval between sending of subsequent Flow Control PDUs for a given BVC or MS or PFC	$\text{C} < \text{Th}$
Tf	$5 \text{ s} < \text{Tf} < 6\,000 \text{ s}$	Interval after Flow-Control-PFC before SGSN may use SGSN generated Bmax and R	$\text{Tf} > \text{C}$

## Annex A (informative): Change history

Date	TSG#	TSG Doc.	CR	Rev	Cat	Subject/Comment	New
2015-12		-	-	-		Generation of Rel-13 version based on v12.4.0	13.0.0
	GP-68	GP-151194	0418	4		Introduction of Power Efficient Operation (Rel-13)	13.0.0
	GP-68	GP-151121	0419	1		Enhancements to CS/PS coordination	13.0.0
2016-02	GP-69	GP-160082	0424			Removal of enhancements to CS/PS coordination in shared networks	13.1.0
	GP-69	GP-160166	0422	3		Miscellaneous corrections to eDRX	13.1.0
	GP-69	GP-160164	0421	5		Introduction of EC-EGPRS	13.1.0
2016-06	GP-70	GP-160407	0425	1	F	Miscellaneous corrections to eDRX_GSM	13.2.0
2016-06	GP-70	GP-160402	0419	2	B	Enhancements to CS/PS coordination	13.2.0
2016-09	RP-73	RP-161392	0428	1	F	Miscellaneous EC-GSM-IoT Changes	13.3.0
2016-09	RP-73	RP-161392	0429	5	F	Miscellaneous corrections to EC-GSM-IoT	13.3.0
2016-09						Removes CR0427r2 (mistakenly included in v. 13.3.0)	13.3.1

---

# History

<b>Document history</b>		
V13.0.0	January 2016	Publication
V13.1.0	April 2016	Publication
V13.2.0	August 2016	Publication
V13.3.1	November 2016	Publication